

Software Reference for SwitchBlade[®] x908 and x900 Series Switches **AlliedWare Plus[™] Operating System Version 5.3.4-0.1**



SwitchBlade[®] x908
x900-12XT/S
x900-24XS
x900-24XT
x900-24XT-N

Acknowledgments

This product includes software developed by the University of California, Berkeley and its contributors.

Copyright ©1982, 1986, 1990, 1991, 1993 The Regents of the University of California.
All rights reserved.

This product includes software developed by the OpenSSL Project for use in the OpenSSL Toolkit (<http://www.openssl.org/>).

Copyright ©1998-2008 The OpenSSL Project. All rights reserved.

This product includes software licensed under the GNU General Public License available from: <http://www.gnu.org/licenses/gpl2.html>

Source code for all GPL licensed software in this product can be obtained from the Allied Telesis GPL Code Download Center at: <http://www.alliedtelesis.com/support/default.aspx>

Allied Telesis is committed to meeting the requirements of the open source licenses including the GNU General Public License (GPL) and will make all required source code available.

If you would like a copy of the GPL source code contained in Allied Telesis products, please send us a request by registered mail including a check for US\$15 to cover production and shipping costs and a CD with the GPL code will be mailed to you.

GPL Code Request
Allied Telesis Labs (Ltd)
PO Box 8011
Christchurch.
New Zealand

©2010 Allied Telesis Inc. All rights reserved.

This documentation is subject to change without notice. No part of this publication may be reproduced, stored in a retrieval system, or transmitted in any form or any means electronic or mechanical, including photocopying and recording for any purpose other than the purchaser's internal use without the written permission of Allied Telesis, Inc.

Allied Telesis, AlliedWare Plus, EPSRing, SwitchBlade, and VCStack are trademarks or registered trademarks in the United States and elsewhere of Allied Telesis, Inc. Adobe, Acrobat, and Reader are either registered trademarks or trademarks of Adobe Systems Incorporated in the United States and/or other countries. Additional brands, names and products mentioned herein may be trademarks of their respective companies.

Getting the Most from this Manual

Although you can view this document using Acrobat version 5, to get the best from this manual, we recommend using Adobe Acrobat Reader version 8. You can download Acrobat Reader 8 free from <http://www.adobe.com/>.

New Features in This Software Version

For a list of new and enhanced features and commands in this version, see [Appendix B: Changes in Version 5.3.4-0.1](#) (with links to corresponding sections in this Software Reference), or the Software Release Note for Software Version 5.3.4-0.1. Documentation can be downloaded from the Support area of our website at <http://www.alliedtelesis.com>. Note that to download software files, you need a valid user account.

Table of Contents



Part 1 Setting up the Switch

Chapter 1. Getting Started.....	1.1
Introduction.....	1.2
How to Login.....	1.2
How to get Command Help.....	1.3
Viewing a List of Valid Parameters.....	1.3
Completing Keywords.....	1.7
Viewing Command Error Messages.....	1.8
How to Work with Command Modes.....	1.9
Entering Privileged Exec Commands When in a Configuration Mode.....	1.12
How to See the Current Configuration.....	1.14
Default Settings.....	1.15
The Default Configuration Script.....	1.16
How to Change the Password.....	1.17
How to Set Strong Passwords.....	1.18
How to Set a Management IP Address.....	1.20
How to Save and Boot from the Current Configuration.....	1.21
How to Save to the Default Configuration File.....	1.21
How to Create and Use a New Configuration File.....	1.21
How to Return to the Factory Defaults.....	1.23
How to See System Information.....	1.24
Viewing Overall System Information.....	1.24
Viewing Temperature, Voltage, and Fan Status.....	1.25
Viewing the Serial Number.....	1.26
How to Set System Parameters.....	1.26
How to Change the Telnet Session Timeout.....	1.26
How to Name the Switch.....	1.27
How to Display a Text Banner at Login.....	1.28
How to Set the Time and Date.....	1.29
How to Show Current Settings.....	1.29
How to Set the Time and Date.....	1.29
How to Set the Timezone.....	1.30
How to Configure Summer-time.....	1.30
How to Add and Remove Users.....	1.31
Pre-encrypted Passwords.....	1.32
How to Undo Settings.....	1.33
How to Use the <i>no</i> Parameter.....	1.33
How to Use the <i>default</i> Parameter.....	1.33
How to Upgrade the Firmware.....	1.34
Controlling "show" Command Output.....	1.35
Commands Available in each Mode.....	1.37
User Exec Mode.....	1.37
Privileged Exec Mode.....	1.38
Global Configuration Mode.....	1.39
AlliedWare Plus GUI.....	1.41

Chapter 2. Command Syntax Conventions in this Software Reference	2.1
Chapter 3. Start-up Sequence	3.1
AlliedWare Plus Start-up	3.2
Diagnostic Menu	3.2
Bootloader Menu	3.4
Start-up Sequence	3.8
Chapter 4. CLI Navigation Commands	4.1
Command List.....	4.2
Chapter 5. User Access Commands	5.1
Command List.....	5.2
Chapter 6. Creating and Managing Files	6.1
Introduction.....	6.2
Working with files.....	6.2
Listing files.....	6.2
Displaying the contents of configuration and text files.....	6.4
Navigating through the file system.....	6.4
Using the editor.....	6.6
Creating and Using Configuration Files.....	6.8
Creating a Configuration File	6.8
Specifying the Start-up Configuration Script	6.8
Working with Configuration Files.....	6.9
Copying Files To and From Your Device.....	6.10
URL Syntax.....	6.10
Copying files.....	6.10
Copying from a Server to Running Configuration.....	6.15
Chapter 7. File Management Commands	7.1
Introduction.....	7.3
URL Syntax and Keyword Usage.....	7.3
Command List.....	7.4
Chapter 8. System Configuration and Monitoring Commands	8.1
Command List.....	8.2
Chapter 9. Debugging and Logging	9.1
Introduction.....	9.2
Debugging.....	9.2
Logging to terminal.....	9.2
Turning off debugging.....	9.2
Logging.....	9.3
Log Outputs	9.3
Chapter 10. Logging Commands.....	10.1
Command List.....	10.2

Chapter 11. Scripting Commands.....	11.1
Command List.....	11.2
Chapter 12. Interface Commands.....	12.1
Command List.....	12.2
Chapter 13. Interface Testing Commands.....	13.1
Command List.....	13.2

Part 2 Layer Two Switching

Chapter 14. Switching Introduction.....	141
Introduction.....	14.2
Physical Layer Information.....	14.3
Switch Ports.....	14.3
Port ranges.....	14.3
Activating and Deactivating Switch Ports.....	14.4
Autonegotiation.....	14.4
Duplex mode.....	14.4
Speed options.....	14.4
Configuring the port speed.....	14.5
MDI MDIX Connection Modes (10BASE-T).....	14.5
Switch Bay Provisioning.....	14.7
Provisioned Board Classes.....	14.7
Applying Hardware Provisioning.....	14.7
Removing or Changing XEM BAY Provisioning.....	14.8
Displaying Provisioned Configurations.....	14.8
Provisioning and Change Management.....	14.10
Provisioning and Software Version Aspects.....	14.11
The Layer 2 Switching Process.....	14.12
The Ingress Rules.....	14.12
The Learning Process.....	14.13
The Forwarding Process.....	14.14
The Egress Rules.....	14.14
Layer 2 Filtering.....	14.15
Ingress Filtering.....	14.15
Static and Dynamic (LACP) Link Aggregation.....	14.16
Static Channel Groups.....	14.16
Dynamic (LACP) Channel Groups.....	14.17
Storm-control.....	14.19
Loop Protection.....	14.20
Loop Detection.....	14.20
Thrash Limiting.....	14.21
Support for Jumbo Frames.....	14.22
Port Mirroring.....	14.22
Port Security.....	14.23
MAC Address Learn Limits.....	14.23
IEEE 802.1X.....	14.23
Quality of Service.....	14.24
IGMP Snooping.....	14.25

Chapter 15. Switching Commands	15.1
Command List.....	15.3
Chapter 16. VLAN Introduction	16.1
Introduction.....	16.2
Virtual LANs (VLANs)	16.2
Configuring VLANs.....	16.3
VLAN Double Tagging (VLAN Stacking).....	16.5
How Double-Tagged VLANs Work.....	16.5
VLAN Rules for Double Tagging.....	16.5
Restrictions when using Double-Tagged VLANs.....	16.6
Configuring Double-Tagged VLANs.....	16.6
Private VLANs.....	16.8
Membership Rules.....	16.8
Promiscuous Ports	16.9
Host Ports.....	16.9
Private VLAN Operation	16.10
Example Configuration.....	16.11
Chapter 17. VLAN Commands	17.1
Command List.....	17.2
Chapter 18. Spanning Tree Introduction: STP, RSTP, and MSTP	18.1
Introduction.....	18.2
Overview of Spanning Trees.....	18.2
Spanning tree operation	18.2
Spanning tree modes.....	18.4
Spanning Tree Protocol (STP).....	18.5
Configuring STP.....	18.6
Rapid Spanning Tree Protocol (RSTP)	18.7
Configuring RSTP	18.8
Multiple Spanning Tree Protocol (MSTP)	18.10
Multiple Spanning Tree Instances (MSTI)	18.11
MSTP Regions.....	18.12
Common and Internal Spanning Tree (CIST)	18.14
MSTP Bridge Protocol Data Units (BPDUs).....	18.16
Configuring MSTP	18.18
Chapter 19. Spanning Tree Commands.....	19.1
Command List.....	19.2
Chapter 20. Link Aggregation Configuration	20.1
Introduction.....	20.2
Link Aggregation Control Protocol (LACP).....	20.2
Configuring A LACP Channel Group.....	20.3
Configuring A Static Channel Group.....	20.6
Chapter 21. Link Aggregation Commands	21.1
Command List.....	21.2

Part 3 Layer Three, Switching and Routing

Chapter 22. Internet Protocol (IP) Addressing and Protocols	22.1
Introduction	22.2
Address Resolution Protocol (ARP)	22.3
Static ARP Entries	22.3
Timing Out ARP Entries	22.3
Deleting ARP Entries	22.4
Proxy ARP	22.4
ARP Logging	22.7
Domain Name System (DNS)	22.8
Internet Control Message Protocol (ICMP)	22.10
ICMP Router Discovery Protocol (IRDP)	22.11
Checking IP Connections	22.15
Ping	22.15
Traceroute	22.15
IP Helper	22.16
IP Directed Broadcast	22.17
Chapter 23. IP Addressing and Protocol Commands	23.1
Command List	23.2
Chapter 24. IPv6 Introduction	24.1
Introduction	24.2
Overview	24.2
IPv6 Addresses and Prefixes	24.3
Address types	24.3
IPv6 Headers	24.5
The Internet Control Message Protocol (ICMPv6)	24.8
IPv6 Routing	24.10
Integration of IPv4 and IPv6	24.11
IPv6 on your Switch	24.11
Enabling IPv6	24.11
The 6bone Network	24.11
Chapter 25. IPv6 Commands	25.1
Command List	25.2
Chapter 26. IPv6to4 Tunneling Configuration	26.1
Introduction	26.2
6to4 Automatic Tunnel Configuration	26.2
Tunneling Operation	26.2
6to4 tunnels operation and configuration summary	26.3
Example 6to4 configuration	26.4
Chapter 27. IPv6to4 Tunneling Commands	27.1
Command List	27.2

Chapter 28. Routing Protocol Overview	28.1
Introduction	28.2
RIP	28.2
OSPF	28.2
BGP	28.3
PIM-SM	28.4
VRRP	28.4
Chapter 29. Route Selection	29.1
Introduction	29.2
Types of Routes	29.2
Interface Routes	29.2
Static Routes	29.2
Dynamic Routes	29.3
RIB and FIB Routing Tables	29.4
Administrative Distance	29.4
Equal Cost Multipath Routing	29.7
How AlliedWare Plus Deletes Routes	29.7
How AlliedWare Plus Adds Routes	29.8
Chapter 30. Routing Commands	30.1
Command List	30.2
Chapter 31. RIP Configuration	31.1
Introduction	31.2
Enabling RIP	31.2
Specifying the RIP Version	31.4
RIPv2 Authentication (Single Key)	31.6
RIPv2 Text Authentication (Multiple Keys)	31.8
RIPv2 md5 authentication (multiple keys)	31.12
Chapter 32. RIP Commands	32.1
Command List	32.2
Chapter 33. RIPng Configuration	33.1
Introduction	33.2
Enabling RIPng	33.2
Troubleshooting RIPng Adjacency	33.4
Chapter 34. RIPng Commands	34.1
Introduction	34.2
Command List	34.2

Chapter 35. OSPF Configuration	35.1
Introduction	35.2
Terminology	35.2
Enabling OSPF on an Interface	35.3
Setting priority	35.5
Configuring an Area Border Router	35.7
Redistributing Routes Into OSPF	35.8
OSPF Cost	35.9
Configuring Virtual Links	35.12
OSPF Authentication	35.14
Chapter 36. OSPF Commands	36.1
Command List	36.3
Chapter 37. BGP Configuration	37.1
Introduction	37.2
Enabling BGP Peers In The Same Autonomous System	37.2
Enabling BGP Between Different Autonomous Systems	37.3
Route Reflector	37.5
Confederations	37.7
BGP Authentication	37.10
Configuring BGP Graceful Reset	37.12
Configuring BGP Graceful Restart	37.14
Chapter 38. BGP Commands	38.1
Command List	38.4
Chapter 39. Route Map Configuration	39.1
Introduction	39.2
Route-Map	39.2
Chapter 40. Route Map Commands	40.1
Command List	40.2

Part 4 Multicast Applications

Chapter 41. IGMP Snooping Introduction and Configuration	41.1
Introduction	41.2
Configuring IGMP snooping	41.3
Introduction to Query Solicitation	41.4
How Query Solicitation Works	41.4
Query Solicitation Operation	41.5
Speeding up IGMP convergence in a non-looped topology	41.6
Enabling Query Solicitation on multiple switches in a looped topology.....	41.7
Chapter 42. IGMP Multicast Commands	42.1
Introduction	42.2
Command List.....	42.2
Chapter 43. Common Multicast Commands.....	43.1
Command List.....	43.2
Chapter 44. PIM-SM Configuration.....	44.1
Introduction	44.2
Characteristics of PIM-SM	44.2
Roles in PIM-SM.....	44.3
Operation of PIM-SM	44.4
PIM-SM Configuration	44.6
Static Rendezvous Point configuration.....	44.7
Dynamic Rendezvous Point configuration.....	44.9
Bootstrap Router configuration.....	44.11
Chapter 45. PIM-SM Commands.....	45.1
Command List.....	45.2
Chapter 46. PIM-DM Configuration.....	46.1
Introduction	46.2
Characteristics of PIM-DM.....	46.2
PIM-DM Terminology.....	46.3
PIM-DM Configuration.....	46.4
Configuration Example.....	46.4
Verifying Configuration.....	46.6
Chapter 47. PIM-DM Commands.....	47.1
Command List.....	47.2
Chapter 48. MLD Snooping Commands.....	48.1
Introduction	48.2
Command List.....	48.2

Part 5 Access and Security

Chapter 49. Access Control Lists Introduction	49.1
Introduction	49.2
ACL Rules	49.3
ACL Source and Destination Addresses	49.3
ACL Reverse Masking	49.3
ACL Sequence Number Support	49.4
ACL Sequence Number Support Behavior	49.4
ACL Sequence Number Support Applicability	49.4
ACL Sequence Number Support ACL Types	49.5
ACL Sequence Number Support Configuration Examples	49.7
Classifying Your Traffic	49.12
Security ACLs	49.12
QoS ACLs	49.12
Profile Limitations	49.13
ACL Types	49.15
Hardware MAC ACLs	49.16
Hardware IP ACLs	49.17
Actions for Hardware ACLs	49.18
Applying ACLs	49.19
Attaching ACLs to a Port	49.19
Filtering with the QoS Match Filtering Commands	49.21
TCP Flags	49.21
Chapter 50. IPv4 Access Control List (ACL) Commands	50.1
Introduction	50.2
Access List Commands and Prompts	50.2
Command List	50.4
Chapter 51. IPv6 Access Control List (ACL) Commands	51.1
Introduction	51.2
Access List Commands and Prompts	51.2
Command List	51.3
Chapter 52. Quality of Service (QoS)	52.1
Introduction	52.2
QoS Operations	52.2
QoS Packet Information	52.3
Link Layer QoS	52.3
Differentiated Services Architecture	52.4
The Differential Services Field	52.5
Processing pre-marked packets	52.6
Applying QoS on Your Switch	52.7
Classifying your Data	52.7
Class Maps	52.7
Policy Maps	52.10
Premarking your Traffic	52.11
CoS to egress queue premarking	52.12
DSCP to egress queue premarking	52.14
Policing (Metering) Your Data	52.16
Single-rate Three-color Policing	52.17
Two-rate Three-color Policing	52.18

Configuring and Applying a Policer	52.19
Remarking Your Data	52.20
Configuring the Egress Queues.....	52.22
Fabric queues - The Internal Paths	52.22
Egress Queues and QoS markers.....	52.22
Egress Queue Commands Hierarchy	52.23
Egress Queue Shaping.....	52.24
Scheduling.....	52.24
Drop Mode.....	52.26
Egress Queue Mapping	52.33
Storm Protection.....	52.34
QoS and the Switching Fabric.....	52.35
Policy-Based Routing.....	52.36
Practical Example	52.36
Chapter 53. QoS Commands.....	53.1
Command List.....	53.3
Chapter 54. 802.1X Configuration	54.1
Introduction.....	54.2
The 802.1X Implementation.....	54.2
Configuring 802.1X.....	54.2
Chapter 55. 802.1X Commands	55.1
Command List.....	55.2
Chapter 56. Authentication Configuration	56.1
Authentication Introduction.....	56.2
Tri-Authentication Introduction	56.2
Tri-Authentication Configuration	56.2
Configuring a Guest VLAN.....	56.3
Roaming Authentication.....	56.4
Roaming Authentication Overview.....	56.5
Roaming Authentication Feature Interactions.....	56.6
Unauthenticated Supplicant Traffic	56.6
Deciding when a supplicant fails authentication.....	56.8
Authentication Enhancements.....	56.9
Web-authentication Enhancements.....	56.9
Guest VLAN Enhancements.....	56.10
Failed authentication VLAN.....	56.11
Limitations on allowed feature combinations	56.12
Chapter 57. Authentication Commands	57.1
Command List.....	57.3
Chapter 58. AAA Introduction and Configuration.....	58.1
AAA Introduction	58.2
Available functions and server types	58.2
Server Groups and Method Lists	58.2
Configuring AAA Login Authentication	58.4
AAA Configuration Tasks.....	58.4
Sample Authentication Configurations	58.6

Sample 802.1X Authentication Configuration.....	58.6
Sample MAC Authentication Configuration.....	58.7
Sample Web-Authentication Configuration.....	58.8
Sample Tri-Authentication Configuration.....	58.9
Chapter 59. AAA Commands.....	59.1
Command List.....	59.2
Chapter 60. RADIUS Introduction and Configuration	60.1
Introduction.....	60.2
RADIUS Packets.....	60.3
RADIUS Attributes.....	60.4
RADIUS Security.....	60.5
RADIUS Proxy.....	60.6
RADIUS Accounting.....	60.7
RADIUS Configuration.....	60.8
Switch Configuration Tasks.....	60.8
Switch to RADIUS Server Communication	60.9
AAA Server Groups Configuration.....	60.11
RADIUS Configuration Examples.....	60.13
RADIUS Authentication.....	60.13
Single RADIUS Server Configuration.....	60.15
Multiple RADIUS Server Configuration.....	60.15
RADIUS Server Group Configuration.....	60.16
RADIUS Server Configuration using Server Groups.....	60.16
Chapter 61. RADIUS Commands	61.1
Command List.....	61.2
Chapter 62. Local RADIUS Server Introduction and Configuration.....	62.1
Local RADIUS Server Introduction.....	62.2
Enable the Local RADIUS Server.....	62.2
Add the Local RADIUS Server as a RADIUS Server.....	62.3
Add authenticators to the list of authenticators.....	62.3
Configure the Local RADIUS Server User Database.....	62.4
Authenticating login sessions.....	62.4
Creating certificates for single users and all users.....	62.6
Defined RADIUS attributes list	62.7
Chapter 63. Local RADIUS Server Commands.....	63.1
Command List.....	63.2
Chapter 64. Secure Shell (SSH) Introduction.....	64.1
Introduction.....	64.2
Secure Shell on the AlliedWare Plus OS.....	64.2
Configuring the SSH Server	64.4
Creating a Host Key.....	64.4
Enabling the Server.....	64.4
Modifying the Server.....	64.5
Validating the Server Configuration	64.6
Adding SSH Users.....	64.6
Authenticating SSH Users.....	64.7

Adding a Login Banner	64.7
Monitoring the Server and Managing Sessions	64.8
Debugging the Server	64.8
Configuring the SSH Client.....	64.9
Modifying the Client.....	64.9
Adding SSH Servers.....	64.10
Authenticating with a Server.....	64.10
Connecting to a Server and Running Commands.....	64.11
Copying files to and from the Server.....	64.11
Debugging the Client.....	64.11
Chapter 65. Secure Shell (SSH) Configuration	65.1
SSH Server Configuration Example.....	65.2
Chapter 66. Secure Shell (SSH) Commands	66.1
Command List.....	66.2
Chapter 67. DHCP Snooping Introduction	67.1
Introduction.....	67.2
DHCP Snooping.....	67.2
DHCP Snooping Database.....	67.3
DHCP Option 82.....	67.4
Traffic Filtering with DHCP Snooping	67.6
ARP Security.....	67.8
MAC Address Verification.....	67.8
DHCP Snooping Violations	67.8
Interactions with Other Features.....	67.9
Configuration.....	67.10
Configure DHCP Snooping.....	67.10
Disabling DHCP Snooping.....	67.14
Related Features.....	67.14
Chapter 68. DHCP Snooping Commands.....	68.1
Command List.....	68.2

Part 6 Network Availability

Chapter 69. VRRP Introduction	69.1
Introduction	69.2
Virtual Router Redundancy Protocol.....	69.3
VRRP Configuration.....	69.4
VRRP Election and Preempt.....	69.6
VRRP Authentication.....	69.7
VRRP Debugging.....	69.8
Configuration Examples.....	69.9
Chapter 70. VRRP Commands	70.1
Command List.....	70.2
Chapter 71. EPSR Introduction	71.1
Introduction.....	71.2
Ring Components and Operation.....	71.2
Fault Detection and Recovery.....	71.4
Fault Recovery.....	71.4
Restoring Normal Operation	71.6
Managing Rings with Two Breaks.....	71.7
Recovery When One Break is Restored	71.8
Configuration Examples.....	71.10
Single Domain, Single Ring Network.....	71.10
Single Ring, Dual Domain Network.....	71.15
EPSR and Spanning Tree Operation	71.16
Chapter 72. EPSR Commands.....	72.1
Command List.....	72.2

Part 7 Network Management

Chapter 73. NTP Introduction	73.1
Introduction	73.2
Overview	73.2
NTP on the Switch.....	73.3
Troubleshooting.....	73.4
Configuration Example.....	73.5
Chapter 74. NTP Commands	74.1
Command List.....	74.2
Chapter 75. Dynamic Host Configuration Protocol (DHCP) Introduction. 75.1	
Introduction.....	75.2
BOOTP	75.2
DHCP.....	75.2
DHCP Relay Agents	75.2
Configuring the DHCP Server.....	75.3
Create the Pool.....	75.3
Define the Network	75.3
Define the Range.....	75.4
Set the Lease.....	75.4
Set the Options.....	75.4
Configuring the DHCP Relay Agent	75.6
Configuring the DHCP Relay Agent.....	75.6
DHCP Relay Agent Option 82.....	75.7
Configuring the DHCP Client.....	75.10
Clearing Dynamically Allocated Lease Bindings.....	75.11
Chapter 76. Dynamic Host Configuration Protocol (DHCP) Commands .. 76.1	
Command List.....	76.2
Chapter 77. SNMP Introduction	77.1
Introduction.....	77.2
Network Management Framework.....	77.2
Structure of Management Information	77.4
Names.....	77.5
Instances.....	77.6
Syntax	77.6
Access	77.6
Status.....	77.7
Description.....	77.7
The SNMP Protocol.....	77.8
SNMP Versions.....	77.8
SNMP Messages.....	77.8
Polling versus Event Notification.....	77.9
Message Format for SNMPv1 and SNMPv2c	77.9
SNMP Communities (Version v1 and v2c)	77.10
SNMPv3 Entities.....	77.10
SNMP Engine.....	77.10
SNMPv3 Message Protocol Format.....	77.11
SNMPv1 and SNMPv2c	77.12
SNMP MIB Views for SNMPv1 and SNMPv2c	77.12

SNMP Communities.....	77.12
Configuration Example (SNMPv1 and v2).....	77.14
SNMPv3	77.17
SNMP MIB Views for SNMPv3.....	77.17
SNMP Groups.....	77.17
SNMP Users.....	77.17
SNMP Target Addresses.....	77.17
SNMP Target Params.....	77.17
Configuration Example (SNMPv3)	77.18
Using SNMP to Manage Files and Software	77.18
Copy a File to or from a TFTP Server.....	77.19
Upgrade Software and Configuration Files.....	77.20
Chapter 78. SNMP Commands	78.1
Command List.....	78.2
Chapter 79. SNMP MIBs	79.1
Introduction.....	79.2
About MIBs.....	79.2
About SNMP.....	79.2
Obtaining MIBs.....	79.2
Loading MIBs.....	79.3
Allied Telesis Enterprise MIB.....	79.5
AT-SMI-MIB.....	79.6
AT-PRODUCT-MIB.....	79.9
AT-BOARDS-MIB.....	79.10
AT-SYSINFO-MIB.....	79.12
AT-XEM-MIB.....	79.14
AT-ENVMONv2-MIB.....	79.15
AT-VCSTACK-MIB.....	79.20
AT-MIBVERSION-MIB.....	79.25
AT-USER-MIB.....	79.26
AT-RESOURCE-MIB.....	79.28
AT-LICENSE-MIB.....	79.29
AT-TRIGGER-MIB.....	79.32
AT-LOOPPROTECT-MIB.....	79.34
AT-SETUP-MIB.....	79.36
AT-DNS-CLIENT-MIB.....	79.40
AT-NTP-MIB.....	79.41
AT-EPSRv2-MIB.....	79.44
AT-DHCPSN-MIB.....	79.46
AT-FILEv2-MIB.....	79.49
AT-LOG-MIB.....	79.57
AT-IP-MIB.....	79.59
Public MIBs.....	79.61
Private MIBs.....	79.66
Chapter 80. LLDP Introduction	80.1
Introduction.....	80.2
Link Layer Discovery Protocol.....	80.2
LLDP-MED.....	80.3
Voice VLAN.....	80.4
LLDP Advertisements.....	80.4
Type-Length-Value (TLV).....	80.4
LLDP-MED: Location Identification TLV.....	80.7

Transmission and Reception	80.8
LLDP-MED Operation	80.9
Storing LLDP Information.....	80.10
Configuring LLDP.....	80.11
Configure LLDP.....	80.12
Configure LLDP-MED.....	80.14
Configure Authentication for Voice VLAN.....	80.18
Chapter 81. LLDP Commands	81.1
Introduction.....	81.2
Command List.....	81.2
Chapter 82. SMTP Commands.....	82.1
Command List.....	82.2
Chapter 83. RMON Introduction	83.1
Introduction.....	83.2
Overview	83.2
RMON Configuration Example	83.3
Chapter 84. RMON Commands	84.1
Command List.....	84.2
Chapter 85. Triggers Introduction.....	85.1
Introduction.....	85.2
Configuring a Trigger.....	85.2
Troubleshooting Triggers.....	85.4
Chapter 86. Triggers Configuration.....	86.1
Introduction.....	86.2
Restrict Internet Access.....	86.2
Capturing Unusual CPU and RAM Activity	86.3
Seeing Daily Statistics.....	86.5
Chapter 87. Trigger Commands	87.1
Command List.....	87.2
Chapter 88. Ping Polling Introduction	88.1
Introduction.....	88.2
How Ping Polling Works.....	88.2
Configuring Ping Polling	88.4
Creating a Polling Instance.....	88.4
Customizing a Polling Instance.....	88.5
Troubleshooting Ping Polling.....	88.6
Interaction with Other Protocols.....	88.6
Chapter 89. Ping Polling Commands.....	89.1
Command List.....	89.2

Chapter 90. sFlow Introduction.....	90.1
sFlow Introduction.....	90.2
The sFlow Agent	90.3
Sampling Methods.....	90.3
The sFlow Collector	90.5
Configuring sFlow on your Switch.....	90.6
Configuration Procedure.....	90.7
Configuration Examples.....	90.8
sFlow Datagrams	90.14
The sFlow MIB.....	90.16
Chapter 91. sFlow Commands	91.1
Command List.....	91.2

Part 8 Virtual Chassis Stacking

Chapter 92. Stacking Introduction.....	92.1
VCS Introduction.....	92.2
VCS Supported Platforms.....	92.2
Features of Virtual Chassis Stacking	92.2
The Physical Stack	92.3
Two Switch Stack Configuration	92.3
Resilient Stacked Topology.....	92.6
Stack Formation	92.8
The Role of the Stack Master.....	92.8
Stack Management VLAN	92.10
Stack Member Failure and Recovery	92.13
Fixed or Virtual MAC Addressing.....	92.13
Stack Resiliency Link.....	92.14
VCS Failure Recovery.....	92.16
Stack Maintenance	92.16
Provisioning (Stack Members)	92.18
Provisioned Board Classes	92.18
Applying Hardware Provisioning.....	92.19
Removing Hardware Provisioning.....	92.21
Displaying Provisioned Configurations.....	92.22
Provisioning and Configuration Management.....	92.23
Software Version Aspects	92.24
Software Version Auto Synchronization.....	92.25
Introduction	92.25
How Autosynchronization Works.....	92.25
Chapter 93. Stacking Commands	93.1
Introduction.....	93.2
Command List.....	93.3

Appendix A: Command List

Appendix B: Changes in Version 5.3.4-0.1

Appendix C: GUI Reference

Introduction	C.2
Installing and Setting-up the GUI.....	C.3
System Requirements.....	C.3
Installing the GUI to your switch using an SD card	C.3
Installing the GUI to Your Switch Via TFTP server.....	C.5
Using the GUI.....	C.7
System > Status > System Details	C.9
System > Status > System Date and Time.....	C.10
System > Status > Top Ten Utilised Ports	C.10
System > File Management > Copy File.....	C.14
System > File Management > Move File	C.15
System > Stacking > Configure Stacking.....	C.17
System > Stacking > Configure Stack Member	C.18
System > License Management > Add Feature License	C.20
Switching > Ports > Monitor Port.....	C.24
Switching > Ports > Configure Port.....	C.25
Switching > VLANs > Add VLAN.....	C.29
Switching > Link Aggregation > Add Static Channel.....	C.32
Switching > Link Aggregation > Add Dynamic Channel.....	C.32
Switching > FDB Table	C.32
IP > IP Interfaces > Configure Primary IP Address.....	C.36
IP > IP Interfaces > Add Secondary IP Address.....	C.36
IP > Static Routes > Add Static Route.....	C.38
IP > DNS > Add DNS Server.....	C.41
IP > IGMP Snooping > Configure Interface.....	C.43
Management > NTP > Add NTP Association	C.50
Management > Logs > Export Logs	C.55

Appendix D: Glossary

Numerics.....	D.2
A.....	D.2
B.....	D.5
C.....	D.7
D.....	D.9
E.....	D.11
F.....	D.12
G.....	D.12
H.....	D.12
I.....	D.13
J.....	D.14
K.....	D.14
L.....	D.15
M.....	D.16
N.....	D.18
O.....	D.19
P.....	D.19
Q.....	D.22

R.....	D.22
S.....	D.25
T.....	D.28
U.....	D.29
V.....	D.29
W.....	D.31
X.....	D.31
Y.....	D.31
Z.....	D.31

Part 1: Setting up the Switch



- Chapter 1 Getting Started
- Chapter 2 Command Syntax Conventions in this Software Reference
- Chapter 3 Start-up Sequence
- Chapter 4 CLI Navigation Commands
- Chapter 5 User Access Commands
- Chapter 6 Creating and Managing Files
- Chapter 7 File Management Commands
- Chapter 8 System Configuration and Monitoring Commands
- Chapter 9 Debugging and Logging
- Chapter 10 Logging Commands
- Chapter 11 Scripting Commands
- Chapter 12 Interface Commands
- Chapter 13 Interface Testing Commands

Chapter 1: Getting Started



Introduction.....	1.2
How to Login.....	1.2
How to get Command Help.....	1.3
Viewing a List of Valid Parameters.....	1.3
Completing Keywords.....	1.7
Viewing Command Error Messages.....	1.8
How to Work with Command Modes.....	1.9
Entering Privileged Exec Commands When in a Configuration Mode.....	1.12
How to See the Current Configuration.....	1.14
Default Settings.....	1.15
The Default Configuration Script.....	1.16
How to Change the Password.....	1.17
How to Set Strong Passwords.....	1.18
How to Set a Management IP Address.....	1.20
How to Save and Boot from the Current Configuration.....	1.21
How to Save to the Default Configuration File.....	1.21
How to Create and Use a New Configuration File.....	1.21
How to Return to the Factory Defaults.....	1.23
How to See System Information.....	1.24
Viewing Overall System Information.....	1.24
Viewing Temperature, Voltage, and Fan Status.....	1.25
Viewing the Serial Number.....	1.26
How to Set System Parameters.....	1.26
How to Change the Telnet Session Timeout.....	1.26
How to Name the Switch.....	1.27
How to Display a Text Banner at Login.....	1.28
How to Set the Time and Date.....	1.29
How to Show Current Settings.....	1.29
How to Set the Time and Date.....	1.29
How to Set the Timezone.....	1.30
How to Configure Summer-time.....	1.30
How to Add and Remove Users.....	1.31
Pre-encrypted Passwords.....	1.32
How to Undo Settings.....	1.33
How to Use the <i>no</i> Parameter.....	1.33
How to Use the <i>default</i> Parameter.....	1.33
How to Upgrade the Firmware.....	1.34
Controlling "show" Command Output.....	1.35
Commands Available in each Mode.....	1.37
User Exec Mode.....	1.37
Privileged Exec Mode.....	1.38
Global Configuration Mode.....	1.39
AlliedWare Plus GUI.....	1.41

Introduction

This chapter introduces a number of commonly-used management features of the AlliedWare Plus™ Operating System (OS).

How to Login

Step 1: Set the console baud rate

The default baud rate is 9600.

By default the AlliedWare Plus™ OS supports VT100 compatible terminals on the console port. This means that the terminal size is 80 columns by 24 rows.

Step 2: Login with manager/friend

The defaults are:

```
username: manager
```

```
password: friend
```

The switch logs you into User Exec mode. From User Exec mode, you can perform high-level diagnostics (some **show** commands, ping, traceroute etc), start sessions (Telnet, SSH), and change mode.

How to get Command Help

The following kinds of command help are available:

- lists of valid parameters with brief descriptions (the ? key)
- completion of keywords (the Tab key)
- error messages for incomplete or incorrect syntax

Command Abbreviations

The AlliedWare Plus™ CLI contains a number of abbreviations for its commands. For example, the `show interface` command can be entered in the abbreviated form shown below:

```

awplus#
sh in vlan100  sh in vlan100
-----
awplus#
configure terminal24  Enter the Global Configuration mode.
-----
awplus(config)#
router rip24  Define a RIP routing process and enter the Router
              Configuration mode.
-----
awplus(config-router)#
network 10.10.11.0/24  Associate networks with the RIP process
-----
awplus(config-router)#
network 10.10.12.0/24  Associate networks with the RIP process

```

Viewing a List of Valid Parameters

To get syntax help, type ? (i.e. "space question mark") after:

- the prompt. This will list all commands available in the mode you are in.
- one or more parameters. This will list parameters that can come next in the partial command.
- one or more letters of a parameter. This will list matching parameters.



Note The AlliedWare Plus™ OS only displays one screenful of text at a time, with the prompt "--More--" at the end of each screenful. Press the space bar to display the next screenful or the Q key to return to the command prompt.

Example To see which commands are available in Privileged Exec mode, enter "?" at the Privileged Exec mode command prompt:

```
awplus# ?
```

This results in the following output:

Figure 1-1: Example output from the ? command

Exec commands:	
activate	Activate a script
cd	Change the current working directory
clear	Reset functions
clock	Manage clock
configure	Enter configuration mode
copy	Copy from one file to another
debug	Debugging functions (see also 'undebug')
delete	Delete a file
dir	List the files on a filesystem
disable	Turn off privileged mode command
dot1x	IEEE 802.1X Port-Based Access Control
echo	Echo a string
edit	Text Editor
enable	Turn on privileged mode command
erase	Erase the system startup configuration
exit	End current mode and down to previous mode
help	Description of the interactive help system
license	Activate software feature license
logout	Exit from the EXEC
mail	Send an email
mkdir	Make a new directory
move	Rename or move a file
mstat	Show statistics after multiple multicast traceroutes
mtrace	Trace multicast path from source to destination
no	Negate a command or set its defaults
ping	Send echo messages
platform	Execute built-in self-tests
pwd	Print the current working directory
quit	Exit current mode and down to previous mode
reboot	Halt and perform a cold restart
reload	Halt and perform a cold restart
remote-command	Remote stack member command execution
restart	Restart routing protocol
rmdir	Remove a directory
rmon	Debugging functions (see also 'undebug')
show	Show running system information
ssh	Open an SSH connection
tcpdump	Execute tcpdump
telnet	Open a telnet connection
terminal	Set terminal line parameters
test	Test device functionality
traceroute	Trace route to destination
trigger	Automatic scripted responses to device events
undebug	Disable debugging functions (see also 'debug')
wait	Wait for a specified number of seconds
write	Write running configuration to memory, file or terminal

Example To see which commands are available in Configuration mode, enter "?" at the Config mode command prompt:

```
awplus# configure terminal
```

```
awplus(config)# ?
```

This results in the following output:

Figure 1-2: Example output from the ? command

```

Configure commands:
aaa                Authentication,Authorization and Accounting
access-list        Add an access list entry
arp                Address Resolution Protocol (ARP)
auth-web-server    Web authentication server configuration
                  commands
banner            Define a login banner
bgp                Border Gateway Protocol (BGP)
boot              Boot configuration
class-map          Class map command
clock              Manage clock
crypto             Security Specific Commands
cvlan              Configure C-VLAN parameters
debug              Debugging functions (see also 'undebug')
default            Restore default settings
do                To run exec commands in config mode
dot1x              IEEE 802.1X Port-Based Access Control
enable             Modify enable password parameters
epsr               Ethernet Protection Switching Ring (EPSR)
exception          Configure exception settings
exit              End current mode and down to previous mode
fib                FIB information
help              Description of the interactive help system
hostname           Set system's network name
interface          Select an interface to configure
ip                 Internet Protocol (IP)
ipv6               Internet Protocol version 6 (IPv6)
key                Authentication key management
lACP               LACP commands
line               Configure a terminal line
log                Logging control
loop-protection    Loop Protection
mac                mac address
mail               Send an email
max-fib-routes     Set maximum fib routes number
max-static-routes Set maximum static routes number
maximum-access-list Maximum access-list entries
maximum-paths      Set multipath numbers installed to FIB
mls                Multi-Layer Switch(L2/L3)
no                 Negate a command or set its defaults
ntp                Configure NTP
ospf               Open Shortest Path First (OSPF)
ping-poll          Ping Polling
platform           Configure global settings for the switch
                  asic
policy-map         Policy map command
radius-server       Radius server
remote-command      Remote stack member command execution
rip                Routing Information Protocol (RIP)
rmon               Remote Monitoring Protocol (RMON)
route-map           Create route-map or enter route-map command
mode
router             Enable a routing process
router-id           Router identifier for this system
service            Modify use of network based services
show               Show running system information
snmp-server         Enable the snmp agent
spanning-tree       Spanning tree commands
ssh                Secure Shell
stack              Manage VCS feature
system              System properties
telnet              Configure telnet
trigger            Automatic scripted responses to device
                  events
undebug            Disable debugging functions (see also
                  'debug')
username           Establish User Name Authentication
virtual-server       Virtual-server configuration
vlan                Configure VLAN parameters
vrrp                VRRP configuration
    
```

Example To see which **show** commands that start with “i” are available in Privileged Exec mode, enter “?” after **show i**:

```
awplus# show i?
```

This results in the following output:

Figure 1-3: Example output from the `show i?` command

```
interface      Select an interface to configure
ip             Internet Protocol (IP)
ipv6          Internet Protocol version 6 (IPv6)
```

Examples To use the ? help to work out the syntax for the **clock timezone** command, enter the following sequence of commands:

```
awplus(config)# clock ?
```

```
summer-time  Manage summer-time
timezone     Set clock timezone
```

```
awplus(config)# cloc timezone ?
```

```
TIMEZONE    Timezone name, up to 5 characters
```

```
awplus(config)# clock timezone NZST ?
```

```
minus      negative offset
plus       positive offset
```

```
awplus(config)# clock timezone NZST plus ?
```

```
<0-12>     Time zone offset to UTC
```

```
awplus(config)# clock timezone NZST plus 12
```

The above example demonstrates that the ? help only indicates what you can type *next*. For commands that have a series of parameters, like **clock timezone**, the ? help does not make the number of parameters obvious.

Completing Keywords

To complete keywords, type Tab after part of the command.

If only one keyword matches the partial command, the AlliedWare Plus™ OS fills in that keyword. If multiple keywords match, it lists them.

Examples In this example we use Tab completion in successive steps to build the complete command `show ip dhcp server summary`. We have included "<Tab>" to show where to type the Tab key - this is not displayed on screen.

```
awplus# show ip <Tab>
```

Figure 1-4: Example output after entering the command, `show ip <Tab>`

```
as-path-access-list  bgp                community-list
dhcp                 dhcp-relay          domain-list
domain-name         extcommunity-list  filter
forwarding          igmp                interface
irdp                 mroute             mvif
name-server         nat                 ospf
pim                  protocols           rip
route                rpf
```

```
awplus# show ip d<Tab>
```

Figure 1-5: Example output after entering the command, `show ip d<Tab>`

```
dhcp          dhcp-relay    domain-list   domain-name
```

```
awplus# show ip dhcp <Tab>
```

Figure 1-6: Example output from the `show ip dhcp <Tab>` command

```
binding pool          server
```

```
awplus# show ip dhcp server s<Tab>
```

Figure 1-7: Example output from the `show ip dhcp s<Tab>` command

```
statistics          summary
```

Viewing Command Error Messages

The switch displays the following generic error messages about command input:

% Incomplete command—this message indicates that the command requires more parameters. Use the ? help to find out what other parameters are available.

```
awplus# interface
```

```
% Incomplete command.
```

% Invalid input detected at '^' marker—this indicates that the switch could not process the command you entered. The switch also prints the command and marks the first invalid character by putting a '^' under it. Note that you may get this error if you enter a command in the wrong mode, as the following output shows.

```
awplus# interface port1.0.1
```

```
interface port1.0.1
```

```
^
```

```
% Invalid input detected at '^' marker.
```

% Unrecognized command—when you try to use ? help and get this message, it indicates that the switch can not provide help on the command because it does not recognize it. This means the command does not exist, or that you have entered it in the wrong mode, as the following output shows.

```
awplus# interface ?
```

```
% Unrecognized command
```



Note The AlliedWare Plus™ OS does not tell you when commands are successful. If it does not display an error message, you can assume the command was successful.

How to Work with Command Modes

The following figure shows the command mode hierarchy and the commands you use to move to lower-level modes.

Multiple users can telnet and issue commands using the User Exec mode and the Privileged Exec mode. However, only one user is allowed to use the Configure mode at a time. This prevents multiple users from issuing configuration commands simultaneously.

Figure 1-8: AlliedWare Plus™ CLI modes

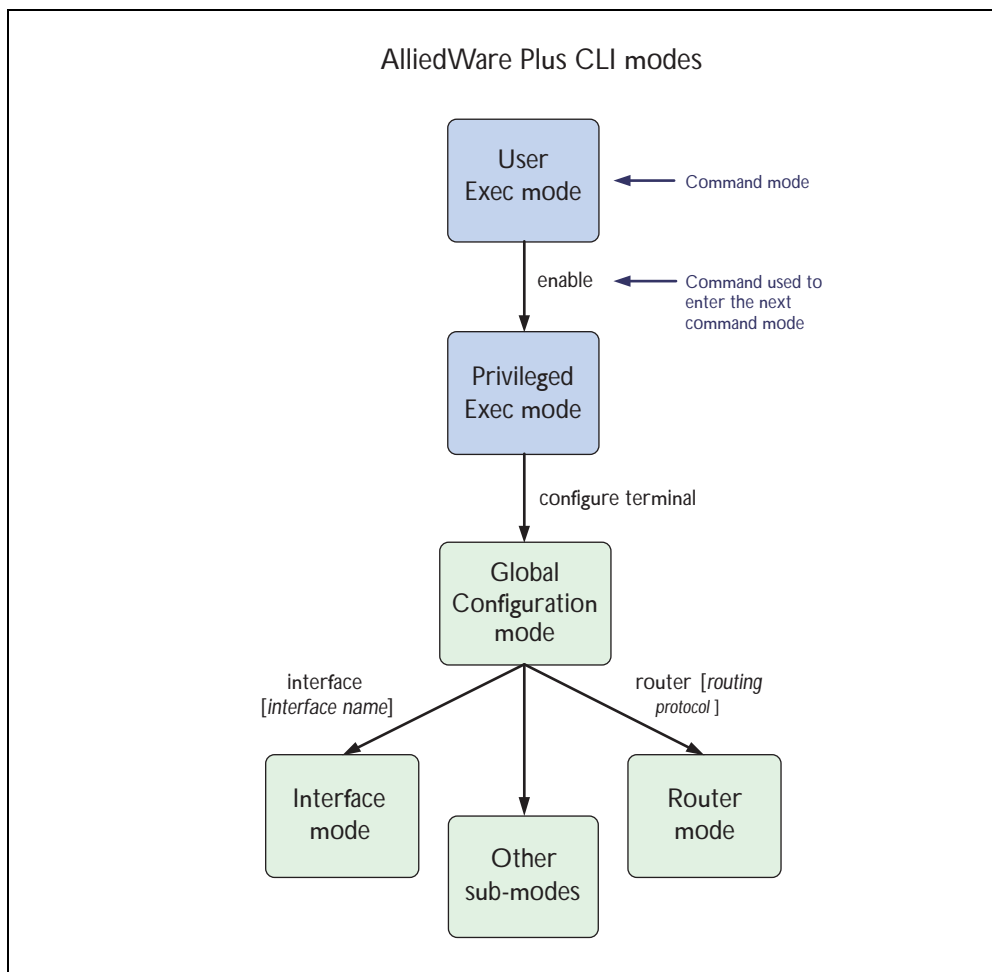

User Exec mode User Exec mode is the mode you log into on the switch.

It lets you perform high-level diagnostics (**show** commands, ping, traceroute etc), start sessions (Telnet, SSH), and change mode.

The default User Exec mode prompt is **awplus>**.

Privileged Exec mode To change from User Exec to Privileged Exec mode, enter the command:

```
awplus> enable
```

Privileged Exec mode is the main mode for monitoring—for example, running **show** commands and debugging. From Privileged Exec mode, you can do all the commands from User Exec mode plus many system commands.

The default Privileged Exec mode prompt is **awplus#**.

Global Configuration mode

To change from Privileged Exec to Global Configuration mode, enter the command:

```
awplus# configure terminal
```

From Global Configuration mode, you can configure most aspects of the switch.

The default Global Configuration mode prompt is `awplus(config)#`.

Lower-level configuration modes

A number of features are configured by entering a lower-level mode from Global Configuration mode. The following table lists these features.

Table 1-1: Features configured using the lower level modes

Mode	What it configures	Command	Default prompt
Interface	Switch ports, VLANs, the management Eth port.	<code>interface <name></code>	<code>awplus(config-if)#</code>
Class map	QoS classes, which isolate and name specific traffic flows (classes) from all other traffic.	<code>class-map <name></code>	<code>awplus(config-cmap)#</code>
EPSR	Ethernet Protection Switching Ring, a loop protection mechanism with extremely fast convergence times.	<code>epsr configuration</code>	<code>awplus(config-epsr)#</code>
Line	Console port settings or virtual terminal settings for telnet.	<code>line console 0</code> <code>line vty <number></code>	<code>awplus(config-line)#</code>
Ping poll	Ping polling, which checks whether specified devices are reachable or not.	<code>ping-poll <number></code>	<code>awplus(config-ping-poll)#</code>
Policy map	QoS policies, a collection of user-defined QoS classes and the default class.	<code>policy-map <name></code>	<code>awplus(config-pmap)#</code>
Policy map class	The QoS actions to take on a class-map, and which class-maps to associate with a QoS policy. This mode is a sub-mode of Policy map mode.	(in Policy map mode) <code>class <name></code>	<code>awplus(config-pmap-c)#</code>
Route map	Route maps, which select routes to include or exclude from the switch's routing table and/or route advertisements.	<code>route-map <name></code> <code>deny permit</code> <code><entry-number></code>	<code>awplus(config-route-map)#</code>
Router	Routing using BGP, IP, IPv6, OSPF, RIP, or VRRP.	<code>router <protocol></code> <code><other-parameters></code>	<code>awplus(config-router)#</code>
MST	Multiple Spanning Tree Protocol.	<code>spanning-tree mst</code> <code>configuration</code>	<code>awplus(config-mst)#</code>
Trigger	Triggers, which run configuration scripts in response to events.	<code>trigger <number></code>	<code>awplus(config-trigger)#</code>
VLAN database	VLANs.	<code>vlan database</code>	<code>awplus(config-vlan)#</code>

Some protocols have commands in both Global Configuration mode and lower-level configuration modes. For example, to configure MSTP, you use:

- Global Configuration mode to select MSTP as the spanning tree mode
- MST mode to create instances and specify other MSTP settings
- Interface Configuration mode to associate the instances with the appropriate ports.

Returning to higher-level modes

The following figure shows the commands to use to move from a lower-level mode to a higher-level mode.

Figure 1-9: Returning to higher-level modes

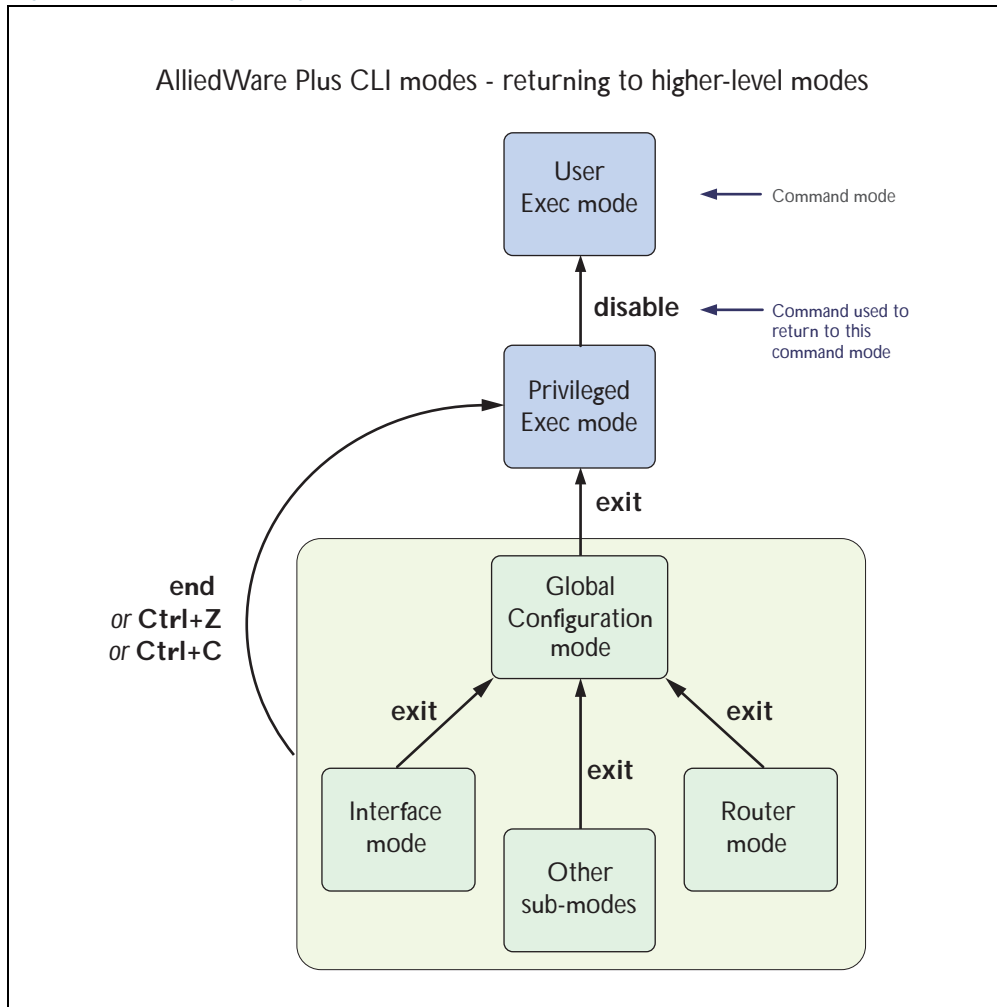

Examples To go from Interface Configuration to Global Configuration mode:

```
awplus(config-if)# exit
awplus(config)#
```

To go from Interface Configuration to Privileged Exec mode:

```
awplus(config-if)# end
awplus#
```

To go from Privileged Exec to User Exec:

```
awplus# exit
awplus>
```

Entering Privileged Exec Commands When in a Configuration Mode

As you configure the switch you will be constantly entering various **show** commands to confirm your configuration. This requires constantly changing between configuration modes and Privileged Exec mode.

However, you can run Privileged Exec commands without changing mode, by using the command:

```
do <command you want to run>
```

You cannot use the ? help to find out command syntax when using the **do** command.

Example To display information about the IP interfaces when in Global Configuration mode, enter the command:

This results in the following output:

```
awplus(config)# do show ip int brief
```

Figure 1-10: Example output after entering the command, do show ip int brief

Interface	IP-Address	Status	Protocol
vlan1	unassigned	admin up	running
vlan2	unassigned	admin up	running

Main Command Modes Summary Table 1-2 lists the main command modes, how to access each mode, the prompt for each command mode. From any mode, use **exit** to move up a mode, or **end** to move to the Privileged Exec mode.

Table 1-2: Main command modes and modal prompts

Present Mode	Prompt	Command	New Mode
User Exec	awplus>	enable	Privileged Exec
Privileged Exec	awplus#	configure terminal	Global Configuration
Global Configuration	awplus(config)#	vlan database	VLAN Configuration
Global Configuration	awplus(config)#	line vt <line-number>	Line Configuration

Sub-modes Summary The table below lists the sub-modes, how to access each mode, the prompt for each command mode, and how to exit that mode. Prompts listed use the default **awplus**.

Table 1-3: Sub-modes, prompt for each sub-mode, how to access each sub-mode, and how to exit each sub-mode

Mode	Prompt and Command Examples	How to Enter Mode	How to Exit Mode
Ping Poll Configuration	awplus#configure terminal awplus(config)#ping-poll awplus(config-ping-poll)#	Use the ping-poll command available from the Global Configuration mode.	Use the exit command to return to the Global Configuration mode. Use the end command to return to the Privileged Exec mode.
Route Map Configuration	awplus#configure terminal awplus(config)#route-map route1 permit 1 awplus(config-route-map)#	Use the route-map command available from the Global Configuration mode.	Use the exit command to return to the Global Configuration mode. Use the end command to return to the Privileged Exec mode.
Router Configuration	awplus#configure terminal awplus(config)#router rip awplus(config-router)#	Use one of the following commands available from the Global Configuration mode: <ul style="list-style-type: none"> ■ router rip ■ router ipv6 rip ■ router ospf ■ router bgp ■ router vrrp 	Use the exit command to return to the Global Configuration mode. Use the end command to return to the Privileged Exec mode.
MST (Multiple Spanning Tree) Configuration	awplus#configure terminal awplus(config)#spanning-tree mst configuration awplus(config-mst)#	Use the spanning-tree mst configuration command available from the Global Configuration mode.	Use the exit command to return to the Global Configuration mode. Use the end command to return to the Privileged Exec mode.
Trigger Configuration	awplus#configure terminal awplus(config)#trigger 1 awplus(config-trigger)#	Use the trigger command from Global Configuration mode.	Use the exit command to return to the Global Configuration mode. Use the end command to return to the Privileged Exec mode.
EPSR Configuration	awplus#configure terminal awplus(config)#epsr configuration awplus(config-epsr)#	Use the epsr configuration command available from the Global Configuration mode.	Use the exit command to return to the Global Configuration mode. Use the end command to return to the Privileged Exec mode.
Class Map Configuration (QoS)	awplus#configure terminal awplus(config)#class map cmap1 awplus(config-cmap)#	Use the class-map command available from the Global Configuration mode.	Use the exit command to return to the Global Configuration mode. Use the end command to return to the Privileged Exec mode.
Policy Map Configuration (QoS)	awplus#configure terminal awplus(config)#policy-map pmap1 awplus(config-pmap)#	Use the policy-map command available from the Global Configuration mode.	Use the exit command to return to the Global Configuration mode. Use the end command to return to the Privileged Exec mode.

Table 1-3: Sub-modes, prompt for each sub-mode, how to access each sub-mode, and how to exit each sub-mode

Mode	Prompt and Command Examples	How to Enter Mode	How to Exit Mode
Policy Map Class Configuration (QoS)	<pre>awplus#configure terminal awplus(config)#policy-map pmap1 awplus(config-pmap)#class cmap1 awplus(config-pmap-c)#</pre>	Use the <code>class</code> command available from the Policy map mode.	Use the <code>exit</code> command to return to the Policy Map Configuration mode. Use the <code>end</code> command to return to the Privileged Exec mode.

How to See the Current Configuration

The current configuration is called the running-config. To see it, enter the following command in either Privileged Exec mode or any configuration mode:

```
awplus# show running-config
```

To see only part of the current configuration, enter the command:

```
awplus# show running-config |include <word>
```

This displays only the lines that contain *word*.

To start the display at a particular place, enter the command:

```
awplus# show running-config |begin <word>
```

This searches the running-config for the first instance of *word* and begins the display with that line.

Note The `show running-config` command works in all modes except User Exec mode.



Default Settings

When the switch first starts up with the AlliedWare Plus™ OS, it applies default settings and copies these defaults dynamically into its running-config.

These default settings mean that the AlliedWare Plus™ OS:

- encrypts passwords, such as user passwords
- records log message priority in log messages
- turns on jumbo frame support for all ports
- turns on the telnet server so that you can telnet to the switch
- enables the switch to look up domain names (but for domain name lookups to work, you have to configure a DNS server)
- turns off L3 multicast packet switching in the switch's hardware. This prevents L3 multicast from flooding the switch's CPU in its default state as an L2 switch
- sets the maximum number of ECMP routes to 8
- turns on RSTP on all ports. Note that the ports are not set to be edge ports
- sets all the switch ports to access mode. This means they are untagged ports, suitable for connecting to hosts
- creates VLAN 1 and adds all the switch ports to it
- allows logins on the serial console port
- allows logins on VTY sessions (for telnet etc)
- has switching enabled, so layer 2 traffic is forwarded appropriately without further configuration
- allocates all the routing table memory space to IPv4 and IPv6 routes
- has ports set to autonegotiate their speed and duplex mode
- has copper ports set to auto MDI/MDI-X mode

The Default Configuration Script

Most of the above default settings are in the form of commands, which the switch copies to its running-config when it first boots up.

The switch stores a copy of the default configuration commands in the file, **default.cfg** and uses this as its default start-up file.

For more information about start-up files, see [“How to Save and Boot from the Current Configuration” on page 1.21](#).

The following table shows the contents of the default file.

Contents of default file	Description
!	An empty comment line (comments begin with an !).
service password-encryption !	Forces passwords in the script to be encrypted.
log record-priority	Records log message priority.
username manager privilege 15 password 8 \$1\$bJoVec4D\$JwOJGPr7YqoExA0GVasdEO	Specifies the password for the manager user
service telnet !	Turns on the telnet server.
ip domain-lookup !	Allows domain name lookups.
no ip multicast-routing !	Turns off L3 multicast packet switching in the switch hardware.
maximum-paths 8	Sets maximum number of ECMP routes.
spanning-tree mode rstp !	Turns on RSTP.
interface eth0 !	A heading for any configuration settings for the management eth0 port. There are no eth0 settings.
interface port1.0.1-1.0.24 switchport switchport mode access !	Sets each switch port to access mode.
interface vlan1 !	Creates VLAN 1.
line con 0	A heading for any configuration settings for the console port. There are no console port settings.
line vty 0 32 ! end	A heading for any configuration settings for VTY sessions. There are no VTY session settings.

How to Change the Password

To change the password for the manager account, enter Global Configuration mode and enter the following command:

```
awplus(config)# username manager password <new-password>
```

The password can be up to 23 characters in length and include characters from up to four categories. The password categories are:

- uppercase letters: A to Z
- lowercase letters: a to z
- digits: 0 to 9
- special symbols: all printable ASCII characters not included in the previous three categories. The question mark ? cannot be used as it is reserved for help functionality.

How to Set Strong Passwords

The password security rules are disabled by default. To set password security rules for users with administrative rights, or privilege level 15, enter Global Configuration mode.

You can then either specify whether the user is forced to change an expired password at the next login, or specify whether the user is not allowed to login with an expired password. You will need to specify a password lifetime greater than 0 before selecting either of these features. Note that the **security-password forced-change** and the **security-password reject-expired-pwd** commands cannot be enabled concurrently.

Password lifetime Enter the following command to specify the password lifetime in days:

```
awplus(config)# security-password lifetime <0-1000>
```

Note that the value 0 will disable lifetime functionality and passwords will never expire. If lifetime functionality is disabled, the **security-password forced-change** command and the **security-password warning** command are also disabled.

Password forced change To specify that a user is forced to change an expired password at the next login, enter the following command:

```
awplus(config)# security-password forced-change
```

If the **security-password forced-change** command is enabled, users with expired passwords are forced to change to a password that must comply with the current password security rules at the next login.

Reject expired password To specify that a user is not allowed to login with an expired password, enter the following command:

```
awplus(config)# security-password reject-expired-pwd
```

If the **security-password reject-expired-pwd** command is enabled, users with expired passwords are rejected at login. Users then have to contact the Network Administrator to change their password.

Caution



Once all users' passwords are expired you are unable to login to the device again if the **security-password reject-expired-pwd** command has been executed. You will have to reboot the device with a default configuration file, or load an earlier software version that does not have the security password feature.

We recommend you never have the command line "security-password reject-expired-pwd" in a default config file.

Use other password security rules to further configure password security settings.

Password warning To specify the number of days before the password expires that the user will receive a warning message specifying the remaining lifetime of the password, enter the command:

```
awplus(config)# security-password warning <0-1000>
```

The value 0 will disable warning functionality and the warning period must be less than, or equal to, the password lifetime.

Password history To specify the number of previous passwords that are unable to be reused enter the command:

```
awplus(config)# security-password history <0-15>
```

The value 0 will disable history functionality. If history functionality is disabled, all users' password history is reset and all password history is lost. A new password is invalid if it matches a password retained in the password history.

Password minimum length To specify the minimum allowable password length, enter the command:

```
awplus(config)# security-password minimum-length <1-23>
```

Password minimum categories To specify the minimum number of categories that the password must contain in order to be considered valid, enter the command:

```
awplus(config)# security-password minimum-categories <1-4>
```

The password categories are:

- uppercase letters: A to Z
- lowercase letters: a to z
- digits: 0 to 9
- special symbols: all printable ASCII characters not included in the previous three categories. The question mark ? cannot be used as it is reserved for help functionality

To ensure password security, the minimum number of categories should align with the lifetime selected, i.e. the fewer categories specified the shorter the lifetime specified.

How to add a user is described in "[How to Add and Remove Users](#)" on page 1.31.

Display security password settings To list the configuration settings for the various security password rules, enter the command:

```
awplus(config)# show security-password configuration
```

To list users remaining lifetime or last password change, enter the command:

```
awplus(config)# show security-password user
```

How to Set a Management IP Address

This section describes how to set an IP address on the eth0 management port.

Step 1: If desired, check the current configuration

After logging in, enter Privileged Exec mode by using the command:

```
awplus>enable
```

Then check the current configuration by using one of the following commands:

```
awplus# show ip interface eth0 brief
```

This results in the following output:

Interface	IP-Address	Status	Protocol
eth0	172.28.8.200	admin up	running

```
awplus# show running-config interface eth0
```

This results in the following output:

```
!  
interface eth0  
  ip address 172.28.8.200/16  
!
```

Step 2: Enter Interface Configuration mode for the eth0 interface

Enter Global Configuration mode and enter the command:

```
awplus(config)# interface eth0
```

Step 3: Enter the IP address and mask

Enter the command:

```
awplus(config-if)# ip address <address/mask>
```

For example, to set the address to 172.28.8.210/16, enter the command:

```
awplus(config-if)# ip address 172.28.8.210/16
```

How to Save and Boot from the Current Configuration

This section tells you how to save your configuration and run the saved configuration when the switch starts up.

You can either:

- save the configuration to the switch's default configuration file (called "default.cfg"). By default, the switch uses that file at start-up.
- create a new configuration file and set the switch to use the new configuration file at start-up.

How to Save to the Default Configuration File

Enter Privileged Exec mode and enter the command:

```
awplus# copy running-config startup-config
```

The parameter **startup-config** is a short-cut for the current boot configuration file, which will be the default configuration file unless you have changed it, as described in the next section.

How to Create and Use a New Configuration File

Step 1: Copy the current configuration to a new file

Enter Privileged Exec mode and enter the command:

```
awplus# copy running-config <filename>.cfg
```

Example To save the current configuration in a file called example.cfg, enter the command

```
awplus# copy running-config example.cfg
```

Step 2: Set the switch to use the new file at startup

To run the new file's configuration when the switch starts up, enter Global Configuration mode and enter the command:

```
awplus(config)# boot config-file <filename>.cfg
```

Example To run the commands in example.cfg on startup, enter the command

```
awplus(config)# boot config-file example.cfg
```

Step 3: Display the new settings

To see the files that the switch uses at startup, enter Privileged Exec mode and enter the command:

```
awplus# show boot
```

The output looks like this:

```
Boot configuration
-----
Current software   : r1-5.3.2.rel
Current boot image : flash:/r1-5.3.2.rel
Backup boot image : Not set
Default boot config: flash:/.configs/default.cfg
Current boot config: flash:/example.cfg (file exists)
```

Step 4: Continue updating the file when you change the configuration

When you next want to save the current configuration, enter Privileged Exec mode and enter the command:

```
awplus# copy running-config startup-config
```

The parameter **startup-config** is a short-cut for the current boot configuration file.

How to Return to the Factory Defaults

The switch dynamically adds the default settings to the running-config at start-up if the default file is not present. This section describes how to use this feature to return to the factory defaults.

Note  After reboot the show running-config output will show the default factory settings for your switch once you have removed the default.cfg file. To recreate the default.cfg file enter copy running-config startup-config. When you enter copy running-config startup-config commands the default.cfg file is updated with the startup-config.

Completely restore defaults

To completely remove your configuration and return to the factory default configuration, delete or rename the default file and make sure no other file is set as the start-up configuration file.

To find the location of the default boot configuration file, enter Privileged Exec mode and enter the command:

```
awplus# show boot
```

To delete the default file when it is the current boot configuration file, enter Privileged Exec mode and enter either of the commands:

```
awplus# delete force <filename>
```

or:

```
awplus# erase startup-config
```

Note that erasing startup-config deletes the current boot configuration file—it does not simply stop the file from being the boot file.

To make sure that no other file is loaded at start-up, enter Global Configuration mode and enter the command:

```
awplus(config)# no boot config-file
```

Partially restore defaults

To partially restore the default settings, make a configuration file that contains the settings you want to keep and set this as the start-up configuration file. On start-up, the switch will add the missing settings to the running-config.

For example, to use default settings but still keep an IP address on the eth0 management port, create a file like the following one and set it as the boot configuration file:

```
awplus# show file eth0-ip.cfg
```

The output looks like this:

```
!  
interface eth0  
  ip address 172.28.8.210/16  
!  
ip route 0.0.0.0/0 172.28.0.1  
!  
end
```

How to See System Information

This section describes how to view the following system information:

- overview information
- details of temperature and voltage
- serial number

Viewing Overall System Information

To display an overview of the switch hardware, software, and system settings, enter User Exec or Privileged Exec mode and enter the command:

```
awplus# show system
```

The output looks like this:

```
Switch System Status                               Fri Dec  5 02:55:58 2008
Board      ID  Bay  Board Name                               Rev  Serial number
-----
Base       280      x900-24XT-N                               A-0  45AX5300X
PSU        212  PSU2  AT-PWR01-AC                               B-1  61400717
Fan module 214  PSU1  AT-FAN01                                  F-1  66111841
-----
RAM:  Total: 514264 kB Free: 372404 kB
Flash: 31.0MB Used: 14.8MB Available: 16.2MB
-----
Environment Status : Normal
Uptime              : 0 days 02:12:03
Bootloader version  : 1.0.9
Current software    : r1-5.3.1.rel
Software version    : 5.3.1
Build date          : Mon Dec 15 14 13:04:00 NZDT 2008
Current boot config: flash:/default.cfg (file exists)
Territory           : japan
System Name
System Contact
System Location
```

Viewing Temperature, Voltage, and Fan Status

The switch monitors the environmental status of the switch and its power supplies and fan. To display this information, enter User Exec or Privileged Exec mode and enter the command:

```
awplus# show system environment
```

The output looks like the following figure. This device has a power supply unit in the first PSU bay and a fan in the second PSU bay.

```
Environment Monitoring Status
Overall Status: Normal

Resource ID: 1 Name: PSU bay 1
ID Sensor (Units) Reading Low Limit High Limit Status
1 Device Present Yes - - Ok
2 PSU Overtemp No - - Ok
3 PSU Fan Fail No - - Ok
4 PSU Power Output No - - Ok

Resource ID: 2 Name: PSU bay 2
ID Sensor (Units) Reading Low Limit High Limit Status
1 Device Present Yes - - Ok
2 PSU Overtemp No - - Ok
3 PSU Fan Fail No - - Ok
4 PSU Power Output Yes - - Ok

Resource ID: 3 Name: x900-24XT-N
ID Sensor (Units) Reading Low Limit High Limit Status
1 Voltage: 2.5V (Volts) 2.565 2.344 2.865 Ok
2 Voltage: 1.65V (Volts) 1.629 1.488 1.816 Ok
3 Voltage: 3.3V (Volts) 3.334 2.973 3.627 Ok
4 Voltage: 1.8V (Volts) 1.771 1.615 1.979 Ok
5 Voltage: 12V (Volts) 12.000 10.813 13.188 Ok
6 Temp: Ambient (Degrees C) 33 -127 55 Ok
7 Temp: Mid Internal (Degrees C) 52 -127 85 Ok
8 Temp: Bk Internal (Degrees C) 47 -127 75 Ok
```

Viewing the Serial Number

The switch's serial number is displayed in the output of the [show system command on page 8.40](#), but for convenience, you can also display it by itself. To do this, enter User Exec or Privileged Exec mode and enter the command:

```
awplus# show system serialnumber
```

The output looks like this:

```
P1FY7502C
```

How to Set System Parameters

You can set system parameters to personalize the switch and make it easy to identify it when troubleshooting. This section describes how to configure the following system parameters:

- telnet session timeout
- switch name
- login banner

How to Change the Telnet Session Timeout

By default, telnet sessions time out after 10 minutes of idle time. If desired, you can change this.

To change the timeout for all telnet sessions, enter Global Configuration mode and enter the commands:

```
awplus(config)# line vty 0 32
awplus(config-line)# exec-timeout <new-timeout>
```

The new timeout value only applies to new sessions, not current sessions.

Examples To set the timeout to 30 minutes, enter the command:

```
awplus(config-line)# exec-timeout 30
```

To set the timeout to 30 seconds, enter the command:

```
awplus(config-line)# exec-timeout 0 30
```

To set the timeout to infinity, so that sessions never time out, enter either of the commands:

```
awplus(config-line)# no exec-timeout
```

```
awplus(config-line)# exec-timeout 0 0
```

How to Name the Switch

To give the switch a name, enter Global Configuration mode and enter the command:

```
awplus(config)# hostname <name>
```

For example, to name the switch "switch1.mycompany.com":

```
awplus(config)# hostname switch1.mycompany.com
```

The prompt displays the new name:

```
awplusswitch1.mycompany.com(config)#
```

The name can contain hyphens and underscore characters.

However, the name must be a single word, as the following example shows.

```
awplus(config)#hostname switch1.mycompany.com more words
hostname switch1.mycompany.com more words
                        ^
% Invalid input detected at '^' marker.
```

It also cannot be surrounded by quote marks, as the following example shows.

```
awplus(config)#hostname "switch1.mycompany.com more words"
% Please specify string starting with alphabet
```

Removing the name

To remove the hostname, enter the command:

```
awplusswitch1.mycompany.com(config)# no hostname
```

The prompt changes back to the default prompt:

```
awplus(config)#
```

How to Display a Text Banner at Login

By default, the switch displays the AlliedWare Plus™ OS version and build date at login. You can customize this by changing the *Message of the Day* (MOTD) banner.

To enter a new MOTD banner, enter Global Configuration mode and enter the command:

```
awplus(config)# banner motd <banner-text>
```

The text can contain spaces and other printable characters. You do not have to surround words with quote marks.

Example To display “this is a new banner” when someone logs in, enter the command:

```
awplus(config)# banner motd this is a new banner
```

This results in the following output at login:

```
awplus login: manager
Password:
this is a new banner
awplus>
```

Removing the banner

To return to the default banner (AlliedWare Plus™ OS version and build date), enter the command:

```
awplus(config)# banner motd default
```

To remove the banner instead of replacing it, enter the command:

```
awplus(config)# no banner motd
```

How to Set the Time and Date

There are three aspects to setting the time and date:

- setting the current time and date (“How to Set the Time and Date” on page 1.29)
- setting the timezone (“How to Set the Timezone” on page 1.30)
- configuring the switch to automatically change the time when summer-time begins and ends (“How to Configure Summer-time” on page 1.30)

Instead of manually setting the time, you can use NTP to automatically get the time from another device.

How to Show Current Settings

To display the current time, timezone and date, enter Privileged Exec mode and enter the command:

```
awplus# show clock
```

The output looks like this:

```
UTC Time:   Wed,  3 Dec 2008 16:08:14 +0000
Timezone:  UTC
Timezone Offset: +00:00
Summer time zone: None
```

How to Set the Time and Date

To set the time and date, enter Privileged Exec mode and enter the `clock set` command:

```
clock set <hh:mm:ss> <day> <month> <year>
```

:where:

- *hh* is two digits giving the hours in 24-hour format (e.g. **14**)
- *mm* is two digits giving the minutes
- *ss* is two digits giving the seconds
- *day* is two digits giving the day of the month
- *month* is the first three letters of the month name (e.g. **sep**)
- *year* is four digits giving the year

Example To set the time to 14:00:00 on 25 January 2008, use the command:

```
awplus# clock set 14:00:00 25 jan 2008
```

How to Set the Timezone

To set the timezone, enter Global Configuration mode and enter the `clock timezone` command:

```
clock timezone <timezone-name> {plus|minus} <0-12>
```

The `<timezone-name>` can be any string up to 6 characters long.

To return the timezone to UTC+0, enter the command:

```
awplus(config)# no clock timezone
```

Example To set the timezone to Eastern Standard Time, use the command:

```
awplus(config)# clock timezone EST minus 5
```

How to Configure Summer-time

There are two approaches for setting summer-time:

- *recurring*, when you specify the week when summer-time starts and ends and each year the switch changes the time at those weeks. For example, Eastern Daylight Time (EDT) starts at 2 am on the second Sunday in March and ends at 2 am on the first Sunday in November.
- *date-based*, when you specify the start and end dates for summer-time for a particular year. For example, Eastern Daylight Time (EDT) starts at 2 am on Sunday, 8 March 2008 and ends at 2 am on Sunday, 2 November 2008.

Recurring To set summer-time with recurring dates, enter Global Configuration mode and enter the `clock summer-time recurring` command:

```
clock summer-time <zone-name> recurring <start-week> <start-day> <start-month> <start-time> <end-week> <end-day> <end-month> <end-time> <1-180>
```

The `<zone-name>` can be any string up to 6 characters long.

The `<start-time>` and `<end-time>` are in the form `hh:mm`, in 24-hour time.

Note that if you specify 5 for the week, this changes the time on the last day of the month, not the 5th week.

Example To configure EDT, enter the command:

```
awplus(config)# clock summer-time EDT recurring 2 Sun Mar 02:00
1 Sun Nov 02:00 60
```

Date-based To set summer-time for a single year, enter Global Configuration mode and enter the `clock summer-time date` command:

```
clock summer-time <zone-name> date <start-day> <start-month> <start-year> <start-time> <end-day> <end-month> <end-year> <end-time> <1-180>
```

The `<zone-name>` can be any string up to 6 characters long.

The `<start-time>` and `<end-time>` are in the form `hh:mm`, in 24-hour time.

Example For example, to configure EDT for 2008 enter the command:

```
awplus(config)# clock summer-time EDT date 8 Mar 2008 02:00 2
Nov 2008 02:00 60
```

How to Add and Remove Users

Adding users To add a new user with administrative rights, enter Global Configuration mode and enter the command:

```
awplus(config)# username <name> privilege 15 password
<password>
```

Both *<name>* and *<password>* can contain any printable character and are case sensitive.

When you add a user with administrative rights, *<password>* will have to conform to the rules specified by the [security-password minimum-categories command on page 5.12](#) and the [security-password minimum-length command on page 5.13](#). If the [security-password history command on page 5.9](#) is enabled, *<password>* is invalid if it matches a password retained in the password history.

The AlliedWare Plus™ OS gives you a choice of **1** or **15** for the privilege level. Level **1** users are limited to User Exec mode so you need to set most users to level **15**.

For example, to add user Bob with password 123\$%^, enter the command:

```
awplus(config)# username Bob privilege 15 password
123$%^
```

Removing users To remove a user, enter Global Configuration mode and enter the command:

```
no username <name>
```

For example, to remove user Bob, enter the command:

```
awplus(config)# no username Bob
```

Note that you can delete all users, including the user called "manager" and the user you are logged in as. If all privilege **15** user accounts are deleted, a warning message is generated:

```
% Warning: No privileged users exist.
```

If all privilege level **15** user accounts are deleted, and there are no other users configured for the device, you may have to reboot with the default configuration file.

If there is a user account on the device with a lower privilege level and a password has already been set with the [enable password command on page 5.3](#), you can login and still enter privileged mode. When executing the **enable** command, enter the password created with the **enable password** command. For example, if the password is mypassword:

```
awplus> enable mypassword
awplus#
```

Displaying users To list the currently logged-in users, enter User Exec or Privileged Exec mode and enter the command:

```
awplus# show users
```

The output looks like this:

Line	User	Host(s)	Idle	Location
130 vty 0	manager	idle	01:36:37	10.33.27.11
131 vty 1	Bob	idle	00:00:00	10.33.22.13

To list all configured users, enter User Exec or Privileged Exec mode and enter the command:

```
awplus# show running-config |include username
```

The output looks like this:

```
username manager privilege 15 password 8 $1$bJoVec4D$JwOJGPr7YqoExA0GVasdE0
username Bob privilege 15 password 8 $1$gXJLY8dw$iqkMXLgQxbzSOutNUa5E2.
```

Pre-encrypted Passwords

The running-config output above includes the number 8 after the **password** parameter. This indicates that the password is displayed in its encrypted form.

You can enter the number 8 and a pre-encrypted password on the command line. You may want to pre-encrypt passwords if you need to load them onto switches via an insecure method (such as HTTP, or by emailing them to remote users).



Caution Only enter the number 8 if you are entering a pre-encrypted password—otherwise, you will be unable to log in using the password and will be unable to access the switch through that username. The next section describes why.

Testing this feature

If you want to test the effect of this, *create a new user* for the test instead of using the manager user. The test stops you from logging in as the test user, so you need to have the manager user available to log in as.

The following output shows how specifying the number 8 puts the password into the running-config exactly as you typed it:

```
awplus(config)#username Bob privilege 15 password 8 friend
awplus(config)#show running-config |include username Bob
username Bob privilege 15 password 8 friend
```

After entering the command above, logging in as “Bob” with a password of “friend” does not work. This is because the switch takes the password you enter (“friend”), hashes it, and compares the hash with the string in the running-config (“friend”). The hashed value and “friend” are not the same, so the switch rejects the login.

How to Undo Settings

There are two possibilities for undoing settings: the **no** parameter and the **default** parameter.

How to Use the *no* Parameter

To undo most settings, simply re-enter the first parameters of the configuration command with the parameter **no** before them.

Example You can set the timezone to Eastern Standard Time by entering the command:

```
awplus(config)# clock timezone EST minus 5
```

To remove the timezone setting, enter the command:

```
awplus(config)# no clock timezone
```

How to Use the *default* Parameter

Some commands have a **default** parameter that returns the feature to its default setting.

Example You can change the login banner to “this is a new banner” by entering the command:

```
awplus(config)# banner motd this is a new banner
```

To return to the default banner, enter the command:

```
awplus(config)# banner motd default
```

Note that this command also has a **no** parameter that lets you remove the banner altogether.

How to Upgrade the Firmware

New releases of the AlliedWare Plus™ OS become available regularly. Contact your customer support representative for more information.

Step 1: Put the new release onto your TFTP server

Step 2: If necessary, create space in the switch's Flash memory for the new release

Note that you cannot delete the current release file.

To see how much space is free, use the command:

```
awplus# show file system
```

Step 3: Copy the new release from your TFTP server onto the switch

Follow the instructions in ["Copying with Trivial File Transfer Protocol \(TFTP\)"](#) on page 6.13.

Step 4: Set the switch to boot from the new release

Enter Global Configuration mode and enter the command:

```
awplus(config)# boot system <filename>.rel
```

Step 5: Check the boot settings

Enter Privileged Exec mode and enter the command:

```
awplus# show boot
```

Step 6: Reboot

Enter Privileged Exec mode and enter the command:

```
awplus# reload
```

Controlling “show” Command Output

You can control the output of **show** commands by using the | and > or >> tokens in the following ways:

- To display only part of the output, follow the command with | and then other keywords (see [Output Modifiers](#) below)
- To save the output to a file, follow the command with > *filename*
- To append the output to an existing file, follow the command with >> *filename*

Using the ? after typing the **show** command displays the following information about these tokens:

```
awplus# show users

| Output modifiers
> Output redirection
>> Output redirection (append)
```

Output Modifiers Type the | (vertical bar) to use Output modifiers.

```
append      Append output
begin       Begin with the first line that contains matching output
exclude     Exclude lines that contain matching output
include     Include lines that contain matching output
redirect    Redirect output
```

Begin The **begin** parameter causes the display to begin at the first line that contains the input string.

```
awplus# show run | begin vlan1
```

```
...skipping
interface vlan1
 ip address 192.168.14.1
 !!
line con 0
 login
line vty 0 4
 login
 !
end
```

Exclude The **exclude** parameter excludes all lines of output that contain the input string. In the following output all lines containing the word “input” are excluded:

```
awplus# show interface vlan1 | exclude input
```

```
Interface vlan1
Scope: both
Hardware is Ethernet, address is 192.168.14.1
index 3 metric 1 mtu 1500 <UP,BROADCAST,RUNNING,MULTICAST>
VRF Binding: Not bound
Label switching is disabled
No Virtual Circuit configured
Administrative Group(s): None
DSTE Bandwidth Constraint Mode is MAM
  output packets 4438, bytes 394940, dropped 0
  output errors 0, aborted 0, carrier 0, fifo 0, heartbeat 0,
window 0
  collisions 0
```

Include The **include** parameter includes only those lines of output that contain the input string. In the output below, all lines containing the word “input” are included:

```
awplus# show interface vlan1 | include input
```

```
input packets 80434552, bytes 2147483647, dropped 0, multicast
packets 0
input errors 0, length 0, overrun 0, CRC 0, frame 0, fifo 1,
missed 0
```

Redirect The **redirect** parameter puts the lines of output into the specified file. If the file already exists, the new output overwrites the file's contents; the new output is not appended to the existing file contents.

| **redirect** and **>** are synonyms.

```
awplus# show history | redirect history.txt
```

Output Redirection The output redirection token **>** puts the lines of output into the specified file. If the file already exists, the new output overwrites the file's contents; the new output is not appended to the existing file contents.

| **redirect** and **>** are synonyms.

```
awplus# show history > history.txt
```

Append Output The **append** output token **>>** adds the lines of output into the specified file. The file must already exist, for the new output to be added to the end of the file's contents; the new output is appended to the existing file contents.

| **append** and **>>** are synonyms.

```
awplus# show history >> history.txt
```

Commands Available in each Mode

This appendix lists the commands available in the following command modes:

- “User Exec Mode” on page 1.37
- “Privileged Exec Mode” on page 1.38
- “Global Configuration Mode” on page 1.39

User Exec Mode

```
awplus> ?
```

Exec commands:

clear	Reset functions
debug	Debugging functions (see also 'undebug')
disable	Turn off privileged mode command
echo	Echo a string
enable	Turn on privileged mode command
exit	End current mode and down to previous mode
help	Description of the interactive help system
logout	Exit from the EXEC
mstat	Show statistics after multiple multicast traceroutes
mtrace	Trace multicast path from source to destination
no	Negate a command or set its defaults
ping	Send echo messages
quit	Exit current mode and down to previous mode
remote-command	Remote stack member command execution
rmon	Debugging functions (see also 'undebug')
show	Show running system information
ssh	Open an SSH connection
telnet	Open a telnet connection
terminal	Set terminal line parameters
traceroute	Trace route to destination

Privileged Exec Mode

```
awplus# ?
```

Exec commands:

activate	Activate a script
cd	Change the current working directory
clear	Reset functions
clock	Manage clock
configure	Enter configuration mode
copy	Copy from one file to another
debug	Debugging functions (see also 'undebug')
delete	Delete a file
dir	List the files on a filesystem
disable	Turn off privileged mode command
dot1x	IEEE 802.1X Port-Based Access Control
echo	Echo a string
edit	Text Editor
enable	Turn on privileged mode command
erase	Erase the system startup configuration
exit	End current mode and down to previous mode
help	Description of the interactive help system
license	Activate software feature license
logout	Exit from the EXEC
mail	Send an email
mkdir	Make a new directory
move	Rename or move a file
mstat	Show statistics after multiple multicast traceroutes
mtrace	Trace multicast path from source to destination
no	Negate a command or set its defaults
ping	Send echo messages
platform	Execute built-in self-tests
pwd	Print the current working directory
quit	Exit current mode and down to previous mode
reboot	Halt and perform a cold restart
reload	Halt and perform a cold restart
remote-command	Remote stack member command execution
restart	Restart routing protocol
rmdir	Remove a directory
rmon	Debugging functions (see also 'undebug')
show	Show running system information
ssh	Open an SSH connection
tcpdump	Execute tcpdump

telnet	Open a telnet connection
terminal	Set terminal line parameters
test	Test device functionality
traceroute	Trace route to destination
trigger	Automatic scripted responses to device events
undebug	Disable debugging functions (see also 'debug')
wait	Wait for a specified number of seconds
write	Write running configuration to memory, file or terminal

Global Configuration Mode

awplus(config)# ?

Configure commands:

access-list	Add an access list entry
arp	Address Resolution Protocol (ARP)
auth-web-server	Web authentication server configuration commands
banner	Define a login banner
bgp	Border Gateway Protocol (BGP)
boot	Boot configuration
class-map	Class map command
clock	Manage clock
crypto	Security Specific Commands
cvlan	Configure C-VLAN parameters
debug	Debugging functions (see also 'undebug')
default	Restore default settings
do	To run exec commands in config mode
dot1x	IEEE 802.1X Port-Based Access Control
enable	Modify enable password parameters
epsr	Ethernet Protection Switching Ring (EPSR)
exception	Configure exception settings
exit	End current mode and down to previous mode
fib	FIB information
help	Description of the interactive help system
hostname	Set system's network name
interface	Select an interface to configure
ip	Internet Protocol (IP)
ipv6	Internet Protocol version 6 (IPv6)
key	Authentication key management
lACP	LACP commands
line	Configure a terminal line

log	Logging control
loop-protection	Loop Protection
mac	mac address
mail	Send an email
max-fib-routes	Set maximum fib routes number
max-static-routes	Set maximum static routes number
maximum-access-list	Maximum access-list entries
maximum-paths	Set multipath numbers installed to FIB
mls	Multi-Layer Switch(L2/L3)
no	Negate a command or set its defaults
ntp	Configure NTP
ospf	Open Shortest Path First (OSPF)
ping-poll	Ping Polling
platform	Configure global settings for the switch ASIC
policy-map	Policy map command
radius-server	RADIUS server configuration commands
rip	Routing Information Protocol (RIP)
rmon	Remote Monitoring Protocol (RMON)
route-map	Create route-map or enter route-map command mode
router	Enable a routing process
router-id	Router identifier for this system
security-password	Configure strong security passwords
service	Modify use of network based services
show	Show running system information
snmp-server	Manage snmp server
spanning-tree	Spanning tree commands
ssh	Secure Shell
stack	Virtual Chassis Stacking (VCS)
system	System properties
telnet	Configure telnet
trigger	Select a trigger to configure
undebg	Disable debugging functions (see also 'debug')
username	Establish User Name Authentication
virtual-server	Virtual-server configuration
vlan	Configure VLAN parameters
vrrp	VRRP configuration

AlliedWare Plus GUI

Information on loading and using the AlliedWare Plus™ GUI is outside the scope of the main body of this reference manual. This topic is covered in a separate appendix to this document. See [Appendix C: GUI Reference](#).

Chapter 2: Command Syntax Conventions in this Software Reference

The following table describes how command line interface syntax is shown in this Software Reference.

Syntax element	Example	What to enter in the command line
Keywords are shown in lowercase fixed-width font or bold variable-width font	<code>show spanning-tree mst</code> or <code>show ip route</code>	Some keywords are required, and others are optional parameters. Type keywords exactly as they appear in the command syntax.
Number ranges are enclosed in angle-brackets < > and separated by a hyphen.	<0-255>	Enter a number from the range. Do not enter the angle brackets.
Placeholders are shown in lowercase italics within angle-brackets < >, or in uppercase italics	< <i>port-list</i> > or <code>ip dhcp pool <i>NAME</i></code>	Replace the placeholder with the value you require. The place holder may be an IP address, a text string, or some other value. See the parameter table for the command for information about the type of value to enter. Do not enter the angle-brackets.
Repeats are shown with ellipsis.	<code>param1...</code>	Enter the parameter one or more times.
Optional elements are shown in brackets: []	<code>vlan <vid> [name <vlan-name>]</code>	If you need the optional parameter, enter it. Do not enter the brackets.
Required choices are enclosed in braces and separated by a vertical bar (pipe): { }.	<code>spanning-tree {mstp rstp stp} enable</code>	Enter one only of the options. Do not enter the braces or vertical bar.
Optional choices are enclosed in or brackets and separated by a vertical bar (pipe): []	<code>[param1 param2]</code>	If needed, enter one only of the options. Do not enter the brackets or vertical bar.
Inclusive options are enclosed in braces, and separated by brackets: {[]}.	<code>{ [param1] [param2] [param3] }</code>	Enter one or more of the options and separate them with a space. Do not enter the braces or brackets.

Chapter 3: Start-up Sequence



AlliedWare Plus Start-up.....	3.2
Diagnostic Menu.....	3.2
Bootloader Menu.....	3.4
Start-up Sequence.....	3.8

AlliedWare Plus Start-up

Every switch has a start-up process. A specified version of product software must be loaded and executed. The bootloader is the executable code responsible for setting up the system and loading the release software.

The bootloader is the software that runs the unit when it first powers up, performing basic initialization and executing the product software release. As part of the start-up process of the switch, the bootloader allows you various options before running the product release software.

Previous versions of AlliedWare provide the option to boot to EPROM if a software release cannot be loaded, is unlicensed, or if selected by the user. The EPROM provides enough basic functionality to get a working software release loaded and operational on the switch. In AlliedWare Plus™ this task is handled by the bootloader.

As AlliedWare Plus™ begins its start-up process, there are two options that allow you to access either the diagnostic menu, or the bootloader menu. The following prompt is displayed when these options are temporarily available:

```
Bootloader 1.0.9 loaded
Press <Ctrl+B> for the Boot Menu
```

You can now enter one of the following two options to determine how the start-up process proceeds:

- Enter Ctrl+D to display the diagnostic menu.
- Enter Ctrl+B to display the bootloader menu.

Diagnostic Menu

Enter Ctrl+D during start-up to access the bootloader diagnostic menu, and provide options for performing various hardware tests. This can be useful as a tool for confirming a suspected hardware problem at the direction of network engineering personnel. When you enter Ctrl+D, the stage 1 diagnostics menu is displayed:

```
Bootup Stage 1 Diagnostics Menu:
0. Restart
1. Full RAM test
2. Quick RAM test
3. Battery backed RAM (NVS) test
4. Bootloader ROM checksum test
-----
7. Bootup stage 2 diagnostics menu
-----
8. Quit to U-Boot shell
9. Quit and continue booting
Enter selection ==>
```

The options in the stage 1 diagnostics menu allow you to initiate the following tests:

- **RAM**
The Bootloader fully tests any/all SDRAM installed in the system.
- **NVS**
The Bootloader fully tests any/all non-volatile (battery backed) SRAM installed in the system.
- **checksum**
The Bootloader checksum ROM memory for error detection.

For example, enter "2" to select a Quick RAM test:

```
Quick RAM test - press Q to quit, S to skip when failing
Writing pattern .....
Checking pattern .....
Writing complemented pattern .....
Checking complemented pattern .....
Pass 1 total errors 0
```

Enter "7" to display the stage 2 diagnostics menu:

```
Entering stage 2...
Bootup Stage 2 Diagnostics Menu:
 0. Restart
 2. Test FLASH (Filesystem only)
 4. Erase FLASH (Filesystem only)
 5. Card slot test
-----
 8. Quit to U-Boot shell
 9. Quit and continue booting
```

The options in the stage 2 diagnostics menu allow you to initiate the following tests:

- **Flash**
The Bootloader tests the user file system area of flash. The bootloader is stored in a protected area of flash that is not accessed by the user file system.
- **Flash Erase**
The Bootloader erases the user file system area of flash only.
- **SD (and SDHC) Card slot**
The Bootloader tests the Card slot.

Once any required tests are completed from the diagnostics menu, enter "9" to quit the diagnostic menu and continue the switch boot-up process.

Bootloader Menu

Enter Ctrl+B during start-up to access the bootloader menu where boot options can be set. The boot options shown are explained in detail under this example.

```

Boot Menu:

-----
B. Boot backup software
-----
0. Restart
1. Perform one-off boot from alternate source
2. Change the default boot source (for advanced users)
3. Update Bootloader
4. Adjust the console baud rate
5. Special boot options
6. System information
7. Restore Bootloader factory settings
-----
9. Quit and continue booting

```

Boot options A powerful feature of AlliedWare Plus™ is the ability to boot from a variety of sources. Previously the switch was constrained to just booting off the release loaded into flash memory. The only software release upgrade path being to load a new release into flash memory and then set this release to be loaded at the next restart.

With AlliedWare Plus™ the switch can boot from other sources, such as a memory card or network server. This provides a very flexible system, with multiple options to upgrade software releases and for system recovery.

Details of the bootloader menu options are as follows:

1. Perform one-off boot from alternate source

Enter "1" to provide the following one-off boot options:

```

Enter selection ==> 1
Select device:

0. Return to previous menu
-----
1. Flash    (flash:)
2. SD Card (card:)
3. TFTP     (tftp://)
4. YMODEM  (ymodem:)

Enter selection ==>

```

You can select a one-off boot from flash, SD (or SDHC) card, network server (TFTP), or ymodem. The selected option will be used for the next restart (only) of the switch. If you select to boot from the network, the bootloader prompts the user for the required network address details.

Note These settings are specific to the Bootloader. They are not related in any way to what may be configured by the main software release.



```
Enter IP version [4|6]..... [4]:
Enter IP address for eth0 ..... [0.0.0.0]: 172.28.8.210
Enter subnet mask ..... [0.0.0.0]: 255.255.0.0
Enter gateway IP ..... [0.0.0.0]: 172.28.0.1
Enter TFTP server IP ..... [0.0.0.0]: 172.30.1.242
Enter filename ..... []: r1-5.3.1.rel
Loading tftp://172.30.1.242/r1-5.3.1.rel...
```

When the switch is booted up using the 'one-off' selected source for the software release, it provides the option to copy the release just used to flash for further/ permanent use:

```
login: manager
Password: *****
The system has been booted using the one off boot/recovery
mechanism.
Bootup has successfully completed.
Write this release to flash? (y/n):
```

2. Change the default boot source (for advanced users)

Entering "2" provides the option to set the boot source permanently.

```
NOTE: These settings are specific to the Bootloader.
They are not related in any way to what may be configured
by the 'boot system' command in the main software release.
Select device:

0. Return to previous menu
-----
1. Flash (flash:)
2. SD Card (card:)
3. TFTP (tftp://)
4. YMODEM (ymodem:)
-----
9. Boot from default (determined by main CLI)

Enter selection ==>
```

The same four boot source options are provided as with the one-off selection, but this time every restart of the switch will result in the unit booting from the selected source.

3. Update Bootloader

This option allows for the bootloader code to be updated. It is not detailed here, as it is envisioned that this would rarely need to be done, and only at the request of (and with support from) Allied Telesis engineering.

4. Adjust the console baud rate

The baud rate of the console session is set here to match the terminal program being used for management of the switch when connected directly to the asynchronous port. The switches default value is 9600. The baud rate selected can be set as the 'new' default for future use if preferred.

```
Select baud rate:
  0. Return to previous menu
-----
  1. 9600
  2. 19200
  3. 38400
  4. 57600
  5. 115200
  6. 230400 (Setting can't be made permanent)
  7. 460800 (Setting can't be made permanent)

Enter selection ==> 1

Change your terminal program baud rate to 9600 and press
enter... if for some reason you are unable to do this,
power cycle the device and the existing baud rate will be
restored.
Use this baud rate by default? (Y/N) ==> n
```

5. Special boot options

The special boot options allow for system recovery in the event of a forgotten password or to the default configuration.

```
Special boot options menu:
  0. Return to previous menu
-----
  1. Skip startup script (Use system defaults)

Enter selection ==>
```

6. System information

The system information option provides some details on the hardware platform in use, such as CPU, memory, hardware (MAC) address and so on.

```

System information:

System (Detected values)
-----
CPU:
Type .....: MPC8541E
Speed .....: 666 MHz
Memory:
Total installed ....: 512 MB
Speed .....: 133 MHz
Flash:
Total installed ....: 32 MB
-----

Product information
-----
Compatible software ..: 1 (r1)
Serial .....: 45AX5300X
Manufacture date ....: 03/2005
Product .....: 280
Product name .....: x900-24XT-N
Revision .....: A
First MAC address ....: 00:00:CD:23:55:C8
-----

Boot software information
-----
Version .....: 1.0.9
Build time .....: Aug 3 2007 - 09:07:12
Built by .....: matthewm
Build host .....: matthewm-d1
Build key .....: at9924ts
Compatible products:
 255 .....: AT-9924Ts
 256 .....: AT-9924SPs
 270 .....: x900-24XT
 271 .....: x900-24XS
 280 .....: x900-24XT-N
 287 .....: x900-12XT/S
-----

Press any key to continue...
    
```

7. Restore Bootloader factory settings

This option allows the bootloader to be set back to factory defaults.

Caution This option erases any settings that may have been
 configured by this menu
 Are you sure? (Y/N) ==>

The bootloader menu provides a powerful set of options for flexibility in the way software releases are upgraded on the switch, and system recovery is performed.

Start-up Sequence

The start-up sequence for a device running AlliedWare Plus™ under normal circumstances will be as seen below - this sequence will be seen when everything loads and runs as expected.

Note  To enter the bootloader or diagnostic menus discussed previously, Ctrl+B or Ctrl+D must be entered when prompted before the software modules start loading.

```

Reading flash:r1-main-20081114-2.rel...

Verifying release... OK
Booting...
Starting base/first... [ OK ]

      /\_____/\
     /  \      /  \
    /    \    /    \
   /      \  /      \
  /        \ /        \
 /          \          \
/            \            \
 \            /            /
  \          /          /
   \        /          /
    \      /          /
     \    /          /
      \  /          /
       \/          /

Allied Telesis Inc.
AlliedWare Plus (TM) v5.3.1
Original release filename: r1-main-20081114-2.rel
Built: Fri Nov 14 13:03:59 NZDT 2008 by: maker@awpmaker06-d1

Mounting virtual filesystems... [ OK ]
Mounting static filesystems... [ OK ]
Mounting flash... [ OK ]
Checking NVS filesystem... [ OK ]
Mounting NVS filesystem... [ OK ]
Starting base/dbus... [ OK ]
Starting base/klogd... [ OK ]
Starting base/loopback... [ OK ]
Starting base/sysctl... [ OK ]
Starting base/syslog... [ OK ]
Starting base/appmond... [ OK ]
Starting base/portmapper... [ OK ]
Starting base/cron... [ OK ]
Starting hardware/openhpi... [ OK ]
Starting hardware/timeout... [ OK ]
Starting base/autofs... [ OK ]
Starting base/inet... [ OK ]
Starting base/modules... [ OK ]
Received event baseboard.found
Received event hardware.done
Starting network/startup... [ OK ]
Starting hardware/openhpiolog... [ OK ]
Starting network/trigger... [ OK ]
23:19:53 awplus HPI: HOTSWAP PSU 2 hotswapped in: AT-PWR01-AC
23:19:53 awplus HPI: HOTSWAP FOM 1 hotswapped in: AT-FAN01
Received event network.enabled

Initializing HA processes:
auth, bgpd, cntrd, epsr, exfx, hostd, hsl
imi, irdpd, lacpd, loopprot, mstp, nsm, openhpid
ospfd, pdmd, pimd, ripd, ripngd, rmon, vrrpd

Received event network.initialized
Received event standalone

Assigning Active Workload to HA processes:
hsl, lacpd, loopprot, mstpd, nsm, pdmd, ripngd
rmond, vrrpd, authd, bgpd, epsrd, irdpd, ospfd
pimd, ripd, imi

Received event network.activated

Loading configuration file flash:/ipgw.cfg, please wait.
..
Received event network.configured

awplus login: manager
Password:

AlliedWare Plus (TM) 5.3.1 11/14/08 13:00:27

Bootloader 1.0.9 loaded
Press <Ctrl+B> for the Boot Menu
    
```

There are three possible status results displayed for each module loaded - OK, INFO, ERROR:

- OK means that the module has loaded correctly.
- INFO means that an error occurred, but the device is usable.
- ERROR means that an error occurred and device operation may be affected.

Additional specific information accompanies an INFO or ERROR status result. For example, if a corrupt release file was set as the startup release, the following error message would be seen:

```
Bootloader 1.0.9 loaded
Press <Ctrl+B> for the Boot Menu
Reading filesystem...
Error: Release filename is invalid (should be <release>.rel)
Error: There is no backup release file set
Error: Boot failed. Please recover the system using the Boot Menu
Restarting...Bootloader 1.0.9 loaded
Press <Ctrl+B> for the Boot Menu
```

Whether an error message results in a case of the device being unusable will depend on the specific error and message, so will need to be dealt with on a case by case basis. If a software release has been corrupted, as shown on start-up, a new release may need to be loaded.

Chapter 4: CLI Navigation Commands



Command List	4.2
configure terminal.....	4.2
disable (Privileged Exec mode).....	4.2
do.....	4.3
enable (Privileged Exec mode).....	4.3
end.....	4.4
exit.....	4.4
help	4.5
logout.....	4.5
show cli.....	4.6
show history.....	4.6
show list.....	4.7

Command List

This chapter provides an alphabetical reference for the commands used to navigate between different modes. This chapter also provides a reference for the help and show commands used to help navigate within the CLI.

configure terminal

This command enters the Global Configuration command mode.

Syntax `configure terminal`

Mode Privileged Exec

Example To enter the Global Configuration command mode (note the change in the command prompt), enter the command:

```
awplus# configure terminal
awplus(config)#
```

disable (Privileged Exec mode)

This command exits the Privileged Exec mode, returning the prompt to the User Exec mode. To end a session, use the `exit` command.

Syntax `disable`

Mode Privileged Exec

Example To exit the Privileged Exec mode, enter the command:

```
awplus# disable
>
```

Related Commands `enable (Privileged Exec mode)`
`end`
`exit`

do

This command lets you to run User Exec and Privileged Exec mode commands when you are in a Configuration mode.

Syntax `do <command>`

Parameter	Description
<code><command></code>	Specify the command and its parameters.

Mode Any configuration mode

Example

```
awplus# configure terminal
awplus(config)# do ping 192.0.2.23
```

enable (Privileged Exec mode)

This command enters the Privileged Exec mode.

Syntax `enable`

Mode User Exec

Example The following example shows the use of the **enable** command to enter the Privileged Exec mode (note the change in the command prompt).

```
awplus> enable
awplus#
```

Related Commands [disable \(Privileged Exec mode\)](#)
[exit](#)

end

This command returns the prompt to the Privileged Exec command mode from any other advanced command mode.

Syntax end

Mode All command modes

Example The following example shows the use of the `end` command to return to the Privileged Exec mode directly from Interface mode.

```
awplus# configure terminal
awplus(config)# interface vlan2
awplus(config-if)# end
awplus#
```

Related Commands [disable \(Privileged Exec mode\)](#)
[enable \(Privileged Exec mode\)](#)
[exit](#)

exit

This command exits the current mode, and returns the prompt to the mode at the previous level. When used in User Exec mode, the `exit` command terminates the session.

Syntax exit

Mode All command modes.

Example The following example shows the use of `exit` command to exit Interface mode, and return to Configure mode.

```
awplus# configure terminal
awplus(config)# interface vlan2
awplus(config-if)# exit
awplus(config)#
```

Related Commands [disable \(Privileged Exec mode\)](#)
[enable \(Privileged Exec mode\)](#)
[end](#)

help

This command displays a description of the AlliedWare Plus™ OS help system.

Syntax help

Mode All command modes

Example To display a description on how to use the system help, use the command:

```
awplus# help
```

Output Figure 4-1: Example output from the **help** command

```
When you need help at the command line, press '?'.

If nothing matches, the help list will be empty. Delete
characters until entering a '?' shows the available options.

Enter '?' after a complete parameter to show remaining valid
command parameters (e.g. 'show ?').

Enter '?' after part of a parameter to show parameters that
complete the typed letters (e.g. 'show ip?').
```

logout

This command exits the User Exec or Privileged Exec modes and ends the session.

Syntax logout

Mode User Exec and Privileged Exec

Example To exit the User Exec mode, use the command:

```
awplus# logout
```

show cli

Use this command to display the CLI tree of the current mode.

For information on output options, see [“Controlling “show” Command Output” on page 1.35.](#)

Syntax show cli

Mode All command modes

Example To display the CLI tree of the current mode, use the command:

```
awplus# show cli
```

Output Figure 4-2: Example output from the **show cli** command

```
+-ospf
  +-A.B.C.D
    +-authentication [no ip ospf (A.B.C.D|) authentication]
    +-authentication-key [no ip ospf (A.B.C.D|) authentication-
key]
    +-cost [no ip ospf (A.B.C.D|) cost]
    +-database-filter [no ip ospf (A.B.C.D|) database-filter]
    +-hello-interval [no ip ospf (A.B.C.D|) hello-interval]
    +-message-digest-key
```

show history

This command lists the commands entered in the current session. The history buffer is cleared automatically upon reboot.

The output lists all command line entries, including commands that returned an error.

For information on output options, see [“Controlling “show” Command Output” on page 1.35.](#)

Syntax show history

Mode User Exec and Privileged Exec

Example To display the commands entered during the current session, use the command:

```
awplus# show history
```

Output Figure 4-3: Example output from the **show history** command

```
1 en
2 show ru
3 con t
4 route-map er deny 3
5 exit
6 ex
7 di
```

show list

Use this command to display a list of all the commands relevant to the current mode.

For information on output options, see [“Controlling “show” Command Output” on page 1.35](#).

Syntax `show list`

Mode All command modes.

Example To run the show list command:

```
awplus# show list
```

Output Figure 4-4: Example output from the **show list** command in Configure mode

```
echo LINE
edit
edit URL
enable
erase startup-config
```

Chapter 5: User Access Commands



Command List	5.2
clear line console.....	5.2
clear line vty.....	5.2
enable password.....	5.3
exec-timeout.....	5.6
length (console display).....	5.7
line.....	5.8
privilege level.....	5.8
security-password history.....	5.9
security-password forced-change.....	5.10
security-password lifetime.....	5.11
security-password minimum-categories.....	5.12
security-password minimum-length.....	5.13
security-password reject-expired-pwd.....	5.14
security-password warning.....	5.15
service advanced-vty.....	5.16
service http.....	5.17
service password-encryption.....	5.18
service telnet.....	5.19
service terminal-length.....	5.20
show security-password configuration.....	5.21
show security-password user.....	5.21
show privilege.....	5.22
show telnet.....	5.22
show users.....	5.23
telnet.....	5.24
telnet server.....	5.25
terminal length.....	5.26
username.....	5.27

Command List

This chapter provides an alphabetical reference of commands used to configure user access.

clear line console

This command resets a console line. If a terminal session exists on the line then it is closed.

Syntax `clear line console 0`

Mode Privileged Exec

Example To reset the console use the command:

```
awplus# clear line console 0
```

Related Commands [clear line vty](#)
[show users](#)

clear line vty

This command resets a VTY line. If a session exists on the line then it is closed.

Syntax `clear line vty <0-32>`

Parameter	Description
<0-32>	Line number

Mode Privileged Exec

Example To reset the first vty line, use the command:

```
awplus# clear line vty 1
```

Related Commands [privilege level](#)
[show telnet](#)
[show users](#)

enable password

To set a local password to control access to various privilege levels, use the **enable password** global configuration command. Use the **enable password** command to modify or create a password to be used, and use the **no enable password** command to remove the password.

Note  Do not use encrypted passwords for GUI users. The GUI requires unencrypted user passwords only - not encrypted user passwords. Do not use option 8 for GUI users.

Syntax `enable password [<plain>|8 <hidden>|level <0-15> 8 <hidden>]`

Parameter	Description
<plain>	Specifies the unencrypted password.
8	Specifies a hidden password will follow.
<hidden>	Specifies the hidden encrypted password.
level	Privilege level <0-15>. Level for which the password applies. You can specify up to 16 privilege levels, using numbers 0 through 15. Level 1 is normal EXEC-mode user privileges for User Exec mode. If this argument is not specified in the command or the no variant of the command, the privilege level defaults to 15 (enable mode privileges) for Privileged Exec mode.

Default The privilege level for enable password is level 15 by default. Previously the default was level 1.

Mode Global Configuration

Usage This command enables the Network Administrator to set a password for entering the **enable** mode. There are three methods to enable a password. In the examples below, for each method, the configuration is different: the configuration file output is different, but the password string to be used to enter the **enable** mode is the same (**mypasswd**).

Using Plain Passwords

The plain password is a clear text string that appears in the configuration file as configured.

```
awplus# configure terminal
awplus(config)# enable password mypasswd
awplus(config)# end
```

This results in the following show output

```
awplus#show run
Current configuration:
hostname awplus
enable password mypasswd
!
interface lo
```

Using Encrypted Passwords

Configure an encrypted password using the **service encrypted-password** command. First, use the **enable password** command to specify the string that you want to use as a password (**mypasswd**). Then, use the **service encrypted-password** command to encrypt the specified string (**mypasswd**). The advantage of using an encrypted password is that the configuration file does not show **mypasswd**, it will only show the encrypted string **fU7zHzuutY2SA**.

 **Note** Do not use encrypted passwords for GUI users. The GUI requires unencrypted user passwords only - not encrypted user passwords. Do not use option 8 for GUI users.

```
awplus# configure terminal
awplus(config)# enable password mypasswd
awplus(config)# service password-encryption
awplus(config)# end
```

This results in the following show output

```
awplus#show run
Current configuration:
hostname awplus
enable password 8 fU7zHzuutY2SA
service password-encryption
!
interface lo
```

Using Hidden Passwords

Configure an encrypted password using the **HIDDEN** parameter (**8**) with the **enable password** command. Use this method if you already know the encrypted string corresponding to the plain text string that you want to use as a password. It is not required to use the **service password-encryption** command for this method. The output in the configuration file will show only the encrypted string, and not the text string

```
awplus# configure terminal
awplus(config)# enable password 8 fU7zHzuutY2SA
awplus(config)# end
```

This results in the following show output

```
awplus#show run
Current configuration:
hostname awplus
enable password 8 fU7zHzuutY2SA
!
interface lo
```

Related Commands [service password-encryption](#)
[username](#)
[show running-config](#)

exec-timeout

This command sets the interval your device waits for user input from either a console or VTY connection. Once the timeout interval is reached, the connection is dropped. This command sets the time limit when the console or VTY connection automatically logs off after no activity.

The **no** variant of this command removes a specified timeout and resets to the default timeout (10 minutes).

Syntax `exec-timeout {<minutes>} [<seconds>]`

`no exec-timeout`

Parameter	Description
<code><minutes></code>	<code><0-35791></code> Required integer timeout value in minutes
<code><seconds></code>	<code><0-2147483></code> Optional integer timeout value in seconds

Default The default for the **exec-timeout** command is 10 minutes and 0 seconds (**exec-timeout 10 0**)

Mode Line Configuration

Usage This command is used set the time the telnet session waits for an idle VTY session, before it times out. An **exec-timeout 0 0** setting will cause the telnet session to wait indefinitely. The command **exec-timeout 0 0** is useful while configuring a device, but reduces device security.

If no input is detected during the interval then the current connection resumes. If no connections exist then the terminal returns to an idle state and disconnects incoming sessions.

Examples To set VTY connections to timeout after 2 minutes, 30 seconds if there is no response from the user, use the following commands:

```
awplus# configure terminal
awplus(config)# line vty 0 32
awplus(config-line)# exec-timeout 2 30
```

To reset the console connection to the default timeout of 10 minutes 0 seconds if there is no response from the user, use the following commands:

```
awplus# configure terminal
awplus(config)# line console 0
awplus(config-line)# no exec-timeout
```

Validation Commands `show running-config`

Related Commands `line`
`service telnet`

length (console display)

Use this command to specify the number of rows of output that the device will display before pausing, for the console or VTY line that you are configuring.

If the output from a command is longer than the length of the line the output will be paused and the '-More-' prompt allows you to move to the next screen full of data.

A length of 0 will turn off pausing and data will be displayed to the console as long as there is data to display.

The **no** variant of this command restores the length of a line (terminal session) attached to a console port or to a VTY to its default.

Syntax `length <0-512>`

`no length`

Parameter	Description
<code><0-512></code>	Number of lines on screen. Specify 0 for no pausing.

Mode Line Configuration

Examples To set the terminal session length on the console to 10 rows, use the command:

```
awplus# configure terminal
awplus(config)# line console 0
awplus(config-line)# length 10
```

To display output to the console continuously, use the command:

```
awplus# configure terminal
awplus(config)# line console 0
awplus(config-line)# length 0
```

Related Commands [service terminal-length](#)
[terminal length](#)

line

Use this command to move to line configuration mode for the specified VTYS or the console.

Syntax `line vty <first-line> [<last-line>]`
`line console 0`

Parameter	Description
<code><first-line></code>	<0-32> Specify the first line number.
<code><last-line></code>	<0-32> Specify the last line number.

Mode Global Configuration

Example The following example shows the use of the `line` command to enter the Line command mode in order to configure all VTYS (note the change in the prompt).

```
awplus# configure terminal
awplus(config)# line vty 0 32
awplus(config-line)#
```

privilege level

This command sets a privilege level for VTY or console connections. This privilege level overrides a specific user's privilege.

Syntax `privilege level <0-15>`

Mode Line Configuration

Examples To set the console connection to have the maximum privilege level, use the following commands:

```
awplus# configure terminal
awplus(config)# line console 0
awplus(config-line)# privilege level 15
```

To set all vty connections to have the minimum privilege level, use the following commands:

```
awplus# configure terminal
awplus(config)# line vty 0 5
awplus(config-line)# privilege level 1
```

Related Commands [line](#)
[username](#)

security-password history

This command specifies the number of previous passwords that are unable to be reused. A new password is invalid if it matches a password retained in the password history.

The `no security-password history` command disables the security password history functionality.

Syntax `security-password history <0-15>`

`no security-password history`

Parameter	Description
<0-15>	The allowable range of previous passwords to match against. A value of 0 will disable the history functionality and is equivalent to the <code>no security-password history</code> command. If the history functionality is disabled, all users' password history is reset and all password history is lost.

Default The default history value is 0, which will disable the history functionality.

Mode Global Configuration

Examples To restrict reuse of the three most recent passwords, use the command:

```
awplus# configure terminal
awplus(config)# security-password history 3
```

To allow the reuse of recent passwords, use the command:

```
awplus# configure terminal
awplus(config)# no security-password history
```

Validation Commands `show running-config security-password`
`show security-password configuration`

Related Commands `security-password forced-change`
`security-password lifetime`
`security-password minimum-categories`
`security-password minimum-length`
`security-password reject-expired-pwd`
`security-password warning`

security-password forced-change

This command specifies whether or not a user is forced to change an expired password at the next login. If this feature is enabled, users whose passwords have expired are forced to change to a password that must comply with the current password security rules at the next login.

Note that to use this command, the lifetime feature must be enabled with the [security-password lifetime](#) command and the reject-expired-pwd feature must be disabled with the [security-password reject-expired-pwd](#) command.

The `no security-password forced-change` command disables the forced-change feature.

Syntax `security-password forced-change`
`no security-password forced-change`

Default The forced-change feature is disabled by default.

Mode Global Configuration

Example To force a user to change their expired password at the next login, use the command:

```
awplus# configure terminal
awplus(config)# security-password forced-change
```

Validation Commands `show running-config security-password`
`show security-password configuration`

Related Commands `security-password history`
`security-password lifetime`
`security-password minimum-categories`
`security-password minimum-length`
`security-password reject-expired-pwd`
`security-password warning`

security-password lifetime

This command enables password expiry by specifying a password lifetime in days.

Note that when the password lifetime feature is disabled, it also disables the [security-password forced-change](#) command and the [security-password warning](#) command.

The `no security-password lifetime` command disables the password lifetime feature.

Syntax `security-password lifetime <0-1000>`

`no security-password lifetime`

Parameter	Description
<code><0-1000></code>	Password lifetime specified in days. A value of 0 will disable lifetime functionality and the password will never expire. This is equivalent to the <code>no security-password lifetime</code> command.

Default The default password lifetime is 0, which will disable the lifetime functionality.

Mode Global Configuration

Example To configure the password lifetime to 10 days, use the command:

```
awplus# configure terminal
awplus(config)# security-password lifetime 10
```

Validation Commands `show running-config security-password`
`show security-password configuration`

Related Commands `security-password history`
`security-password forced-change`
`security-password minimum-categories`
`security-password minimum-length`
`security-password reject-expired-pwd`
`security-password warning`
`show security-password user`

security-password minimum-categories

This command specifies the minimum number of categories that the password must contain in order to be considered valid. The password categories are:

- uppercase letters: A to Z
- lowercase letters: a to z
- digits: 0 to 9
- special symbols: all printable ASCII characters not included in the previous three categories. The question mark ? cannot be used as it is reserved for help functionality.

Note that to ensure password security, the minimum number of categories should align with the lifetime selected, i.e. the fewer categories specified the shorter the lifetime specified.

Syntax `security-password minimum-categories <1-4>`

Parameter	Description
<code><1-4></code>	Number of categories the password must satisfy, in the range 1 to 4.

Default The default number of categories that the password must satisfy is 1.

Mode Global Configuration

Example To configure the required minimum number of character categories to be 3, use the command:

```
awplus# configure terminal
awplus(config)# security-password minimum-categories 3
```

Validation Commands `show running-config security-password`
`show security-password configuration`

Related Commands `security-password history`
`security-password forced-change`
`security-password lifetime`
`security-password minimum-length`
`security-password reject-expired-pwd`
`security-password warning`
`username`

security-password minimum-length

This command specifies the minimum allowable password length. This value is checked against when there is a password change or a user account is created.

Syntax `security-password minimum-length <1-23>`

Parameter	Description
<code><1-23></code>	Minimum password length in the range from 1 to 23.

Default The default minimum password length is 1.

Mode Global Configuration

Example To configure the required minimum password length as 8, use the command:

```
awplus# configure terminal
awplus(config)# security-password minimum-length 8
```

Validation Commands `show running-config security-password`
`show security-password configuration`

Related Commands `security-password history`
`security-password forced-change`
`security-password lifetime`
`security-password minimum-categories`
`security-password reject-expired-pwd`
`security-password warning`
`username`

security-password reject-expired-pwd

This command specifies whether or not a user is allowed to login with an expired password. Users with expired passwords are rejected at login if this functionality is enabled. Users then have to contact the Network Administrator to change their password.

Caution  Once all users' passwords are expired you are unable to login to the device again if the security-password reject-expired-pwd command has been executed. You will have to reboot the device with a default configuration file, or load an earlier software version that does not have the security password feature. We recommend you never have the command line "security-password reject-expired-pwd" in a default config file.

Note that when the reject-expired-pwd functionality is disabled and a user logs on with an expired password, if the forced-change feature is enabled with [security-password forced-change](#) command, a user may have to change the password during login depending on the password lifetime specified by the [security-password lifetime](#) command.

The `no security-password reject-expired-pwd` command disables the reject-expired-pwd feature.

Syntax `security-password reject-expired-pwd`
`no security-password reject-expired-pwd`

Default The reject-expired-pwd feature is disabled by default.

Mode Global Configuration

Example To configure the system to reject users with an expired password, use the command:

```
awplus# configure terminal
awplus(config)# security-password reject-expired-pwd
```

Validation Commands `show running-config security-password`
`show security-password configuration`

Related Commands `security-password history`
`security-password forced-change`
`security-password lifetime`
`security-password minimum-categories`
`security-password minimum-length`
`security-password warning`
`show security-password user`

security-password warning

This command specifies the number of days before the password expires that the user will receive a warning message specifying the remaining lifetime of the password.

Note that the warning period cannot be set unless the lifetime feature is enabled with the [security-password lifetime](#) command.

The `no security-password warning` command disables this feature.

Syntax `security-password warning <0-1000>`

`no security-password warning`

Parameter	Description
<code><0-1000></code>	Warning period in the range from 0 to 1000 days. A value 0 disables the warning functionality and no warning message is displayed for expiring passwords. This is equivalent to the <code>no security-password warning</code> command. The warning period must be less than, or equal to, the password lifetime set with the security-password lifetime command.

Default The default warning period is 0, which disables warning functionality.

Mode Global Configuration

Example To configure a warning period of three days, use the command:

```
awplus# configure terminal
awplus(config)# security-password warning 3
```

Validation Commands `show running-config security-password`
`show security-password configuration`

Related Commands [security-password history](#)
[security-password forced-change](#)
[security-password lifetime](#)
[security-password minimum-categories](#)
[security-password minimum-length](#)
[security-password reject-expired-pwd](#)

service advanced-vty

This command enables the advanced-vty help feature. This allows you to use TAB completion for commands. Where multiple options are possible, the help feature displays the possible options.

The **no service advanced-vty** command disables the advanced-vty help feature.

Syntax `service advanced-vty`

`no service advanced-vty`

Default The advanced-vty help feature is enabled by default.

Mode Global Configuration

Examples To disable the advanced-vty help feature, use the command:

```
awplus# configure terminal
awplus(config)# no service advanced-vty
```

To re-enable the advanced-vty help feature after it has been disabled, use the following commands:

```
awplus# configure terminal
awplus(config)# service advanced-vty
```

service http

This command enables the HTTP (Hypertext Transfer Protocol) service. The HTTP service is enabled by default and is required to support the AlliedWare Plus™ GUI Java applet on a Java enabled browser. See [Appendix C: GUI Reference](#) for further information about installing and using the AlliedWare Plus™ GUI.

The `no service http` command disables the HTTP feature.

Syntax `service http`
`no service http`

Default The HTTP service is enabled by default.

Mode Global Configuration

Examples To disable the HTTP service, use the command:

```
awplus# configure terminal
awplus(config)# no service http
```

To re-enable the HTTP service after it has been disabled, use the following commands:

```
awplus# configure terminal
awplus(config)# service http
```

service password-encryption

Use this command to enable password encryption. This is enabled by default. When password encryption is enabled, the device displays passwords in the running config in encrypted form instead of in plain text.

Use the **no service password-encryption** command to stop the device from displaying newly-entered passwords in encrypted form. This does not change the display of existing passwords.

Note  Do not use encrypted passwords for GUI users. The GUI requires unencrypted user passwords only - not encrypted user passwords.

Syntax `service password-encryption`
`no service password-encryption`

Mode Global Configuration

Example

```
awplus# configure terminal
awplus(config)# service password-encryption
```

**Validation
Commands** `show running-config`

Related Commands `enable password`

service telnet

Use this command to enable the telnet server. The server is enabled by default. Enabling the telnet server starts the switch listening for incoming telnet sessions on the configured port.

The server listens on port 23, unless you have changed the port by using the [privilege level command on page 5.8](#).

Use the **no** variant of this command to disable the telnet server. Disabling the telnet server will stop the switch listening for new incoming telnet sessions. However, existing telnet sessions will still be active.

Syntax `service telnet [ip|ipv6]`
`no service telnet [ip|ipv6]`

Default Both the IPv4 and IPv6 telnet servers are enabled by default.
The configured telnet port is TCP port 23 by default.

Mode Global Configuration

Examples To enable both the IPv4 and IPv6 telnet servers, use the following commands:

```
awplus# configure terminal
awplus(config)# service telnet
```

To enable the IPv6 telnet server only, use the following commands:

```
awplus# configure terminal
awplus(config)# service telnet ipv6
```

To disable both the IPv4 and IPv6 telnet servers, use the following commands:

```
awplus# configure terminal
awplus(config)# no service telnet
```

To disable the IPv6 telnet server only, use the following commands:

```
awplus# configure terminal
awplus(config)# no service telnet ipv6
```

Related Commands `clear line vty`
`show telnet`
`telnet server`

service terminal-length

Use this command to specify the number of rows of output that the device will display before pausing, for all console and VTY lines.

Use the **no** variant of this command to remove the length specified by this command. The default length will apply unless you have changed the length for some or all lines by using the [length \(console display\) command on page 5.7](#).

Syntax `service terminal-length <lines>`
`no service terminal-length <lines>`

Parameter	Description
<code>terminal-length</code>	Establish system-wide terminal length configuration.
<code><lines></code>	<0-512> Number of rows that the device will display before pausing.

Mode Global Configuration

Usage This command overrides any lengths set by using the [length \(console display\) command on page 5.7](#) in Line mode.

Example To display 60 rows of text before pausing, use the following command:

```
awplus# configure terminal
awplus(config)# service terminal-length 60
```

Related Commands [service terminal-length](#)
[terminal length](#)

show security-password configuration

This command displays the configuration settings for the various security password rules.

Syntax `show security-password configuration`

Mode Privileged Exec

Example To display the current security-password rule configuration settings, use the command:

```
awplus# show security-password configuration
```

Output Figure 5-1: Example output from the `show security-password configuration` command

```
Security Password Configuration
Minimum password length ..... 8
Minimum password character categories to match ..... 3
Number of previously used passwords to restrict..... 4
Password lifetime ..... 30 day(s)
  Warning period before password expires ..... 3 day(s)
Reject expired password at login ..... Disabled
  Force changing expired password at login ..... Enabled
```

Related Commands `show running-config security-password`
`show security-password user`

show security-password user

This command displays user account and password information for all users.

Syntax `show security-password user`

Mode Privileged Exec

Example To display the system users' remaining lifetime or last password change, use the command:

```
awplus# show security-password user
```

Output Figure 5-2: Example output from the `show security-password user` command

```
User account and password information
-----
UserName          Privilege   GUI-User   Last-PWD-Change   Remaining-lifetime
-----
manager           15         No         21 day(s) ago     9 days
alice             15         No         3 day(s) ago      27 days
bob               15         Yes        45 day(s) ago     Expired
guest             1          No         35 day(s) ago     No Expiry
```

Related Commands `show running-config security-password`
`show security-password configuration`

show privilege

This command displays the current privilege level of the user, either 1 (limited access) or 15 (full access).

Syntax `show privilege`

Mode User Exec and Privileged Exec

Example To show the current privilege level of the user, use the command:

```
awplus# show privilege
```

Output Figure 5-3: Example output from the **show privilege** command

```
Current privilege level is 15
```

show telnet

This command shows the Telnet server settings.

Syntax `show telnet`

Mode User Exec and Privileged Exec

Example To show the Telnet server settings, use the command:

```
awplus# show telnet
```

Output Figure 5-4: Example output from the **show telnet** command

```
Telnet Server Configuration
-----
Telnet server           : Enabled
Protocol                : IPv4, IPv6
Port                    : 23
```

Related Commands `clear line vty`
`service telnet`
`show users`
`telnet server`

show users

This command shows information about the users who are currently logged into the device.

Syntax `show users`

Mode User Exec and Privileged Exec

Example To show the users currently connected to the device, use the command:

```
awplus# show users
```

Output Figure 5-5: Example output from the **show users** command

Line	User	Host(s)	Idle	Location
con 0	manager	idle	00:00:00	ttyS0
vty 0	bob	idle	00:00:03	172.16.11.1

telnet

Use this command to open a telnet session to a remote device.

Syntax `telnet {<hostname>|ip <ipv4-addr>|ipv6 <ipv6-addr>} [<port>]`

Parameter	Description
<code><hostname></code>	The host name of the remote system.
<code>ip</code>	Keyword used to specify the IPv4 address or host name of a remote system.
<code><ipv4-addr></code>	An IPv4 address of the remote system.
<code>ipv6</code>	Keyword used to specify the IPv6 address of a remote system
<code><ipv6-addr></code>	Placeholder for an IPv6 address in the format <code>x:x::x:x</code> , for example, <code>2001:db8::8a2e:7334</code>
<code><port></code>	Specify a TCP port number (well known ports are in the range 1-1023, registered ports are 1024-49151, and private ports are 49152-65535).

Mode User Exec and Privileged Exec

Examples To connect to TCP port 2602 on the device at 10.2.2.2, use the command:

```
awplus# telnet 10.2.2.2 2602
```

To connect to the telnet server `host.example`, use the command:

```
awplus# telnet host.example
```

To connect to the telnet server `host.example` on TCP port 100, use the command:

```
awplus# telnet host.example 100
```

To connect to the telnet server `host.example` with an IPv6 connection, use the command:

```
awplus# telnet ipv6 host.example
```

telnet server

This command enables the telnet server on the specified TCP port. If the server is already enabled then it will be restarted on the new port. Changing the port number does not affect the port used by existing sessions.

Syntax `telnet server {<1-65535>|default}`

Parameter	Description
<code><1-65535></code>	The TCP port to listen on.
<code>default</code>	Use the default TCP port number 23.

Mode Global Configuration

Example To enable the telnet server on TCP port 2323, use the following commands:

```
awplus# configure terminal
awplus(config)# telnet server 2323
```

Related Commands [show telnet](#)

terminal length

Use the **terminal length** command to specify the number of rows of output that the device will display before pausing, for the currently-active terminal only.

Use the **terminal no length** command to remove the length specified by this command. The default length will apply unless you have changed the length for some or all lines by using the [length \(console display\) command on page 5.7](#).

Syntax `terminal length <length>`
`terminal no length [<length>]`

Parameter	Description
<code><length></code>	<0-512> Number of rows that the device will display on the currently-active terminal before pausing.

Mode User Exec and Privileged Exec

Examples The following example sets the number of lines to 15.

```
awplus# terminal length 15
```

The following example removes terminal length set previously.

```
awplus# terminal no length
```

Related Commands [length \(console display\)](#)
[service terminal-length](#)

username

This command creates or modifies a user.

Note  Do not use encrypted passwords for GUI users. The GUI requires unencrypted user passwords only - not encrypted user passwords. Do not use option 8 for GUI users. Do not use punctuation marks, such as single quotes (' '), double quotes (" "), or colons (:) with the user login name. Punctuation marks will cause login issues.

Syntax

```
username <name> privilege <1-15> [guiuser] password [8] <password>
username <name> privilege <1-15> [guiuser]
username <name> password [8] <password>
no username <name>
```

Parameter	Description
<name>	The login name for the user. Do not use punctuation marks, such as single quotes (' '), double quotes (" "), or colons (:) with the user login name.
privilege	The user's privilege level. Use the privilege levels to set the access rights for each user.
<1-15>	A privilege level: either 1-14 (limited access) or 15 (full access). The default manager account on your device cannot be set to a lower privilege level than 15. A user with privilege level 1-14 can only enter Privileged Exec mode if an enable password has been configured and they enter the password.
guiuser	Setup the user account for use with the GUI.
password	A password that the user must enter when logging in.
8	Specifies that you are entering a password as a string that has already been encrypted, instead of entering a plain-text password. The running-config displays the new password as an encrypted string even if password encryption is turned off. Note that the user enters the plain-text version of the password when logging in.
<password>	The user's password. The password can be up to 23 characters in length and include characters from up to four categories. The password categories are: <ul style="list-style-type: none"> ■ uppercase letters: A to Z ■ lowercase letters: a to z ■ digits: 0 to 9 ■ special symbols: all printable ASCII characters not included in the previous three categories. The question mark ? cannot be used as it is reserved for help functionality.

Mode Global Configuration

Examples To create the user `bob` with a privilege level of 15, and the password `bobs_secret`, use the command:

```
awplus# configure terminal
awplus(config)# username bob privilege 15 password bobs_secret
```

To create the GUI user `bob` with a privilege level of 15, and the password `bobs_secret`, use the command:

```
awplus# configure terminal
awplus(config)# username bob privilege 15 guiuser password
bobs_secret
```

Related Commands [enable password](#)
[security-password minimum-categories](#)
[security-password minimum-length](#)

Chapter 6: Creating and Managing Files



Introduction.....	6.2
Working with files.....	6.2
Listing files.....	6.2
Displaying the contents of configuration and text files.....	6.4
Navigating through the file system.....	6.4
Using the editor.....	6.6
Creating and Using Configuration Files.....	6.8
Creating a Configuration File.....	6.8
Specifying the Start-up Configuration Script.....	6.8
Working with Configuration Files.....	6.9
Copying Files To and From Your Device.....	6.10
URL Syntax.....	6.10
Copying files.....	6.10
Copying from a Server to Running Configuration.....	6.15

Introduction

This chapter provides information on:

- Working with files
- Creating and Using Configuration Files
- Copying Files To and From Your Device

Working with files

The AlliedWare Plus™ OS lets you create directory trees for file storage. This section shows:

- “Listing files” on page 6.2—listing files and seeing how much free space you have
- “Displaying the contents of configuration and text files” on page 6.4
- “Navigating through the file system” on page 6.4—identifying the current directory, changing directories, and creating and deleting directories
- “Using the editor” on page 6.6

Flash compaction

The flash memory on the switch automatically compacts itself to recover space available from deleted files. The switch only does this when necessary, and not every file deletion causes flash compaction. Flash compaction can occur after a file of any size is added to or deleted from the switch.

Caution While flash is compacting, the console is unresponsive. Do not restart the switch, as interrupting flash compaction can damage files.



Listing files

To list files, enter Privileged Exec mode and enter the command:

```
awplus# dir
```

The output lists files and directories in order of modification date, descending. It looks like this:

```
-rw-      534 Jul 12 2007 17:52:50  stp.cfg
-rw-      534 Jul 12 2007 17:12:50  example.cfg
-rw- 12429011 Jul 12 2007 16:26:06  r1-5.2.2-rc3.rel
```

Listing files including hidden system files

The **dir** command does not list all files—it hides system files and directories because users generally do not need to create or edit them. To list all files including system files, enter Privileged Exec mode and enter the command:

```
awplus# dir all
```

The output looks like this:

```
drwx      0 Jul 12 2008 17:16:32 ./
-rw-     401 Jul 12 2008 17:16:32 example.cfg
-rw-     534 Jul 12 2008 17:52:50 stp.cfg
-rw- 12429011 Jul 12 2008 16:26:06 r1-5.2.2-rc3.rel
drwx     216 Jul  9 2008 11:31:18 ../
drwx      0 Jun 13 2008 04:31:51 .configs/
-rw-     17 Jun 13 2008 04:27:27 .release
drwx      0 Jul 10 1978 23:40:00 .ssh/
```

The hidden files and directories begin with a dot.

Seeing information about the file system

To display information about the different memory types on the switch, enter Privileged Exec mode and enter the command:

```
awplus# show file systems
```

The output includes the amount of free memory and the prefix you type to access that memory type, and looks like this:

Size(b)	Free(b)	Type	Flags	Prefixes	S/D/V	Lcl/Ntwk	Avail
31.0M	6.0M	flash	rw	flash:	static	local	Y
-	-	system	rw	system:	virtual	local	-
499.0k	444.0k	nvs	rw	nvs:	static	local	Y
-	-	sdcard	rw	card:	dynamic	local	N
-	-	tftp	rw	tftp:	-	network	-
-	-	scp	rw	scp:	-	network	-
-	-	sftp	ro	sftp:	-	network	-
-	-	http	ro	http:	-	network	-

Listing files in a subdirectory

To list the contents of a directory, enter Privileged Exec mode and enter the command:

```
awplus# dir <directory-name>
```

Tip You can specify the directory with or without a / after the directory name.

Example To display the contents of a directory called "example", enter the command:

```
awplus# dir example
```

Listing files in NVS memory or on an SD (or SDHC) card

To list the contents of a directory in NVS, enter Privileged Exec mode and enter the command:

```
awplus# dir nvs:<directory-name>
```

To list the contents of a directory on an SD (or SDHC) card, enter the command:

```
awplus# dir card:<directory-name>
```

Example To display the contents of a directory in NVS called "example", enter the command:

```
awplus# dir nvs:example
```

Displaying the contents of configuration and text files

To display the contents of a file, enter Privileged Exec mode and enter the command:

```
awplus# show file <filename>
```

Example To display the contents of the file called "example.cfg", enter the command:

```
awplus# show file example.cfg
```

Navigating through the file system

Showing the current directory

To see which directory you are currently in, enter Privileged Exec mode and enter the command:

```
awplus# pwd
```

For the top-level directory, the output looks like this:

```
flash:/
```

Changing directories

To change to another directory, enter Privileged Exec mode and enter the command:

```
awplus# cd <directory-name>
```

To go to a directory one level higher in the directory tree, enter the command:

```
awplus# cd ..
```

Example To change to a directory called "example", enter the command:

```
awplus# cd example
```

To go up one level, which returns you to the top level directory, enter the command :

```
awplus# cd ..
```

Changing to a directory in NVS memory or on an SD (or SDHC) card

To change to the top-level directory in the NVS memory file system, enter Privileged Exec mode and enter the command:

```
awplus# cd nvs:
```

To change to the top-level directory on an SD (or SDHC) card, enter the command:

```
awplus# cd card: /
```

Note that the prefix for the SD (or SDHC) card is "card" not "sdcard".

Next, you can change to other directories in NVS memory or on the SD (or SDHC) card, by entering the command:

```
awplus# cd <directory-name>
```

Alternatively, you can go straight from Flash to a subdirectory in the alternative file system, by entering one of the commands:

```
awplus# cd nvs:<directory-name>
```

```
awplus# cd card: /<directory-name>
```

To return to the Flash file system, enter the command:

```
awplus# cd flash: /
```

Example To change to the directory within NVS called "example", enter the command:

```
awplus# cd nvs:example
```

To go up one level, which returns you to the top-level directory of NVS memory, enter the command:

```
awplus# cd ..
```

Creating new directories

To create a directory, enter Privileged Exec mode and enter the command:

```
awplus# mkdir <directory-name>
```

Example To make a directory called “example” within the Flash file system, enter the command:

```
awplus# mkdir example
```

Deleting directories

To delete an empty directory, enter Privileged Exec mode and enter the command:

```
awplus# rmdir <directory-name>
```

To delete a directory and all its contents, enter Privileged Exec mode and enter the command:

```
awplus# delete recursive <directory-name>
```

The switch prompts you for confirmation.

Example To delete an empty directory called “example” from within the Flash file system, enter the command:

```
awplus# rmdir example
```

Using the editor

The inbuilt editor is JOE (Joe’s Own Editor).

To edit an existing file, enter Privileged Exec mode and enter the command:

```
awplus# edit <filename>
```

To open the editor with an empty file, enter the command:

```
awplus# edit
```

When you save the new file, you may need to specify the file system to store it on. For Flash, use `flash:/<filename>`.

Using JOE To format and manipulate text in JOE, you use control-character sequences. The following table summarizes a few useful sequences—for details, see: joe-editor.sourceforge.net/manpage.html.

Function	Control-character sequence
Access the help	Ctrl-K-H
Save the file without exiting (for new files, this prompts for a filename)	Ctrl-K-D
Save the file and exit (this prompts for a filename)	Ctrl-K-X
Exit without saving the file	Ctrl-C
Go to the beginning of the file	Ctrl-K-U
Go to the end of the file	Ctrl-K-V
Go up one full screen of text in the file	Ctrl-U

Function (cont.)	Control-character sequence (cont.)
Go down one full screen of text in the file	Ctrl-V
Select a block of text:	
Mark the beginning of the block	Ctrl-K-B
Mark the end of the block	Ctrl-K-K
Copy and paste a selected block of text	Place cursor at destination then enter Ctrl-K-C
Move a selected block of text	Place cursor at destination then enter Ctrl-K-M
Delete a selected block of text	Ctrl-K-Y

Creating and Using Configuration Files

This section provides instructions on:

- [Creating a Configuration File](#)
- [Specifying the Start-up Configuration Script](#)
- [Working with Configuration Files](#)

Creating a Configuration File

A **configuration file** is a text file that contains a sequence of standard commands for a specific purpose. Configuration files have a **.cfg** extension. Your device has a default configuration script called **default.cfg**.

You can create and edit configuration files on your device by:

- saving the dynamic configuration on the device, known as the **running-config** (see [“Working with Configuration Files”](#)). Use the command:

```
awplus# copy running-config (destination-URL)
```

Where URL specifies a file in flash.

- using the device's text editor. Use the command:

```
awplus# edit (source-URL)
```

where **source-URL** is the name of the copied file in Flash memory.

- creating a file on a remote PC, then copying it to onto your device. See [“Copying files”](#) for more information about using the **copy** commands.

Once you have created a configuration file, you can use it as the **startup-config** file. See [“Specifying the Start-up Configuration Script”](#) for more information.

Specifying the Start-up Configuration Script

When you restart your device, or when it automatically restarts, it executes the pre-configured commands in a configuration script known as the **boot config** or **startup-config** file.

When you first start your device, the script set as the startup-config file is **default.cfg**. If desired, you can overwrite **default.cfg** with another configuration. Alternatively, you can change the startup-config by specifying a new file as the startup-config. Use the command:

```
awplus(config)# boot config-file URL
```

where **URL** specifies the name and location of a configuration file. At the next restart, the device executes the commands in the specified file.

You can change the content of the file set as the startup-config file by:

- entering commands directly into the CLI, then saving this configuration using the command:

```
awplus# copy running-config startup-config
```

This command saves the device's dynamic configuration into the file that is currently configured as the startup-config file.

- writing commands into a configuration file (see "Creating a Configuration File" below), then using the command:

```
awplus# copy SOURCE-URL startup-config
```

This command saves the script from the source file into the file that is currently configured as the startup-config file.

To display the name of the configuration file that is set to execute when the device restarts, enter the command:

```
awplus# show boot
```

To see the commands in the startup-config file, use the command:

```
awplus# show startup-config
```

To erase the file set as the startup-config file, use the command:

```
awplus# erase startup-config
```

At the next restart that occurs after you've erased the file, the device loads the configuration in the file **default.cfg**. This file is set on the system as a backup configuration file that loads if no other file is set as the startup-config file.

Working with Configuration Files

When you use the CLI or GUI to configure your device, it stores this dynamic configuration as a list of commands called the **running-config**. To view the device's running-config, use the command:

```
awplus# show running-config
```

If you turn off the device or restart it, any unsaved changes to the running-config are lost. To save the running-config as a configuration script, use the command:

```
awplus# copy running-config DESTINATION-URL
```

You may have many configuration files. Storing them on a device allows you to keep a backup device with configuration scripts for every device in the network to speed up network recovery time. Multiple scripts also let you test new configuration scripts before setting them as the startup-config. For example, to test a new script named test.cfg, enter the command:

```
awplus# copy flash:/test.cfg running-config
```

This allows you to run a configuration file any time without restarting the device, by replacing the system's current dynamic configuration with the script in the configuration file. However, note that some commands require you to restart the device before they can take effect, such as the **platform** commands.

You can also set a trigger to automatically execute a configuration script when a predetermined event occurs. For information about creating triggers, see [Chapter 85, Triggers Introduction](#).

Copying Files To and From Your Device

This section provides instructions on:

- [URL Syntax](#)
- [Copying files](#)

URL Syntax

Many of the file management commands use the placeholder "URL" to represent the name and location of the file that you want to act on. The following table explains the syntax of this URL for each different type of file location.

When you copy a file...	Use this syntax:
In local Flash memory	<code>flash: [/] [DIRECTORY/] FILENAME</code>
Stored on an SD (or SDHC) card	<code>card: [/] [DIRECTORY/] FILENAME</code>
Copying with Hypertext Transfer Protocol (HTTP)	<code>http:// [[USERNAME:PASSWORD]@] {HOSTNAME HOST-IP} [/FILEPATH] /FILENAME</code>
Copying with Trivial File Transfer Protocol (TFTP)	<code>tftp: [[//LOCATION] /DIRECTORY] /FILENAME</code>
Copying with Secure Copy (SCP)	<code>scp: //USERNAME@LOCATION [/DIRECTORY] [/FILENAME]</code>
Copying with SSH File Transfer Protocol (SFTP)	<code>sftp: [[//LOCATION] /DIRECTORY] /FILENAME</code>

Copying files

To copy files, use the **copy** commands. These commands allow you to copy files:

- between different memory types attached to your device. Use the command:

```
awplus# copy LOCAL-SOURCE LOCAL-DEST
      FILENAME
```

See "Copying within a file system" and "" for further details.

- across a serial connection using ZMODEM. Use the command:

```
awplus# copy zmodem
```

See "Copying with ZMODEM" for further details.

- from your device onto a remote device, or to your device from a remote device. To copy a file across an interface with IP configured, use the command:

```
awplus# copy SOURCE-URL DESTINATION-URL
```

To copy files across these interfaces you can use the following protocols:

- « “Copying with Hypertext Transfer Protocol (HTTP)”
- « “Copying with Trivial File Transfer Protocol (TFTP)”
- « “Copying with Secure Copy (SCP)”
- « “Copying with SSH File Transfer Protocol (SFTP)”

Copying within a file system

Within a directory

To copy a file within the same directory, enter Privileged Exec mode and enter the command:

```
awplus# copy <source-filename> <destination-filename>
```

If the file already exists, the switch asks whether to overwrite it, with a message like this:

```
Overwrite flash:/example.cfg? (y/n) [n]:
```

To overwrite, press the “y” key then the Enter key.

Between directories

To copy a file to another directory within the same file system, enter the command:

```
awplus# copy <source-filename>  
<directory-name>
```

The / after the directory name is required. Otherwise the switch displays an error (“37: Destination file is a directory”).

The switch then prompts you for the destination filename. To give the copy a new name, type the name at the prompt. You can include directory names in the path.

To use the same filename as the original, press the Enter key (do not press the “y” key—that names the copy “y”).

Example To put a copy of example.cfg into the example directory, enter the command:

```
awplus# copy example.cfg example/
```

The prompt and messages look like this:

```
Enter destination file name [example.cfg]:  
Copying from source file, please wait...  
Copying to destination file, please wait...  
0: Successful operation
```

Copying To and From NVS or SD (or SDHC) card

To copy between file systems, you need to specify the file system prefix (NVS: or card:).

For example, to copy from Flash to NVS when your current directory is the top-level Flash directory, enter Privileged Exec mode and enter the command:

```
awplus# copy <source-filename> nvs:
```

The switch prompts you for the filename, as described in the previous section.

To copy from NVS to Flash when your current directory is the top-level Flash directory, enter the command:

```
awplus# copy nvs:<source-filename>  
          <destination-filename>
```

Example To copy the file "example.txt" from the directory in NVS called "example" to the top level of Flash, enter the command:

```
awplus# copy nvs:example/example.txt  
          example.txt
```

Copying with ZMODEM

ZMODEM allows you to copy files from a network host over an asynchronous port. Use the command:

```
awplus# copy zmodem
```

to open Minicom and transfer a file. Alternatively you can specify the file name within the command:

```
awplus# copy SOURCE-URL zmodem
```

For example, to copy the file "july.cfg" from Flash memory using ZMODEM, use the command:

```
awplus# copy flash:/july.cfg zmodem
```

Copying with Hypertext Transfer Protocol (HTTP)

Your device has a built-in HTTP client. The HTTP client enables the device to act as a browser by sending HTTP "get" or "post" requests to an HTTP server. The client is enabled by default.

For example, to load the file "bob.key" onto Flash from the security directory on the web server at www.company.com, use the command:

```
awplus# copy http://www.company.com/  
security/bob.key flash:/bob.key
```

Copying with Trivial File Transfer Protocol (TFTP)

TFTP runs over User Datagram Protocol (UDP). It is simpler and faster than FTP but has minimal capability, such as no provisions for user authentication.

To copy a file from a TFTP server to Flash memory, enter Privileged Exec mode and enter the command:

```
awplus# copy tftp flash
```

Note You can specify the server and filename in the command instead of waiting for prompts. Use a format like the following:



```
copy tftp://172.1.1.1/example.cfg flash
```

The switch prompts you for the:

- TFTP server hostname (you can enter its IP address instead)
- source filename on the TFTP server
- destination filename in Flash on the switch

To copy a file from Flash to a TFTP server, enter the command:

```
awplus# copy flash tftp
```

Follow the prompts for source filename, server, and destination filename.

If the file is not in the top level of the TFTP server, include the path as part of the filename.

Example To copy example.cfg to the TFTP server at 172.1.1.1, enter the command:

```
awplus# copy flash tftp
```

The prompts, responses, and messages look like this:

```
Enter source file name []:example.cfg
Enter destination host name []:172.1.1.1
Enter destination file name [example.cfg]:
Copying from source file, please wait...
Copying to destination file, please wait...
0: Successful operation
```

To load the file "bob.key" from a TFTP server, where the file is in the folder "security", use the command:

```
awplus# copy tftp://security/bob.key flash:/
bob.key
```

Copying with Secure Copy (SCP)

Secure Copy (SCP) provides a secure way to copy files to and from a remote device using SSH. The AlliedWare Plus™ OS includes both a SSH server and a SSH client. You must enable the SSH server before your device accepts connections from SCP clients. See the [Chapter 64, Secure Shell \(SSH\) Introduction](#) for more information.

For example, to load the file "beth.key" onto Flash from the key directory on a remote SSH server at 10.10.0.12, using the username "bob", use the command:

```
awplus# copy scp://bob@10.10.0.12/key/
beth.key flash:/beth.key
```

Copying with SSH File Transfer Protocol (SFTP)

SSH File Transfer Protocol (SFTP) provides a secure way to copy files onto your device from a remote device. The AlliedWare Plus™ OS includes both a SSH server and a SSH client. SFTP provides additional features from SCP, such as allowing you to manipulate the remote files, and halt or resume file transfers without closing the session.

For example, to load the file "rei.cfg" onto Flash memory from the remote server at 10.0.0.5, use the command:

```
awplus# copy sftp://10.0.0.5/rei.cfg flash:/
rei.cfg
```

Copying from a Server to Running Configuration

Use the `copy tftp` variant of the [copy running-config command on page 7.9](#) to load a configuration file from a server to the running configuration of the switch.

The configuration will be added to the running configuration as if the commands were typed in the command line interface.

The resulting configuration file will be a combination of the previous running configuration and the loaded configuration file. The loaded configuration file has precedence.

Chapter 7: File Management Commands



Introduction.....	7.3
URL Syntax and Keyword Usage.....	7.3
Command List.....	7.4
boot backup.....	7.4
boot config-file.....	7.5
boot system.....	7.5
cd.....	7.6
copy current-software.....	7.6
copy debug.....	7.7
copy (local).....	7.8
copy running-config.....	7.9
copy startup-config.....	7.10
copy (URL).....	7.11
copy zmodem.....	7.12
delete.....	7.13
delete debug.....	7.14
dir.....	7.15
edit.....	7.16
edit URL.....	7.17
erase startup-config.....	7.17
license.....	7.18
mkdir.....	7.19
move.....	7.20
move debug.....	7.21
pwd.....	7.21
rmdir.....	7.22
show boot.....	7.23
show file.....	7.24
show file systems.....	7.25
show license.....	7.27
show running-config.....	7.29
show running-config access-list.....	7.31
show running-config as-path access-list.....	7.32
show running-config bgp.....	7.33
show running-config community-list.....	7.34
show running-config dhcp.....	7.35
show running-config full.....	7.36
show running-config interface.....	7.37
show running-config ip pim dense-mode.....	7.40
show running-config ip pim sparse-mode.....	7.40
show running-config ip route.....	7.41
show running-config ipv6 access-list.....	7.41
show running-config ipv6 mroute.....	7.42
show running-config ipv6 prefix-list.....	7.43
show running-config ipv6 route.....	7.44
show running-config key chain.....	7.45
show running-config lldp.....	7.46

show running-config prefix-list.....	7.47
show running-config route-map.....	7.48
show running-config router	7.49
show running-config router-id	7.50
show running-config security-password	7.51
show running-config switch	7.52
show running-config switch lacp.....	7.53
show running-config switch radius-server	7.53
show running-config switch vlan.....	7.54
show startup-config.....	7.55
show version.....	7.56
write file.....	7.57
write memory.....	7.57
write terminal	7.57

Introduction

This chapter provides an alphabetical reference of AlliedWare Plus™ OS file management commands.

URL Syntax and Keyword Usage

Many of the commands in this chapter use the placeholder "URL" to represent the name and location of the file that you want to act on. The following table explains the syntax of this URL for each different type of file location.

When you copy a file...	Use this syntax:
In local Flash memory	[<i>DIRECTORY</i> /] <i>FILENAME</i> or <i>flash</i> [:] [/] [<i>DIRECTORY</i> /] <i>FILENAME</i>
Stored on an SD (or SDHC) card	<i>card</i> [:] [/] [<i>DIRECTORY</i> /] <i>FILENAME</i>
Using Hyper text Transfer Protocol (HTTP)	<i>http</i> [://] [[<i>USERNAME</i> : <i>PASSWORD</i>]@] { <i>HOSTNAME</i> <i>HOST-IP</i> } [/ <i>FILEPATH</i>] / <i>FILENAME</i>
Using Trivial File Transfer Protocol (TFTP)	<i>tftp</i> [:] [[// <i>LOCATION</i>] / <i>DIRECTORY</i>] / <i>FILENAME</i>
Using Secure Copy (SCP)	<i>scp</i> [://] <i>USERNAME</i> @ <i>LOCATION</i> [/ <i>DIRECTORY</i>] [/ <i>FILENAME</i>]
Using SSH File Transfer Protocol (SFTP)	<i>sftp</i> [:] [[// <i>LOCATION</i>] / <i>DIRECTORY</i>] / <i>FILENAME</i>
Stored on stack member Flash to stack master Flash	< <i>stack_hostname</i> >-< <i>stack_member_id</i> >/ <i>flash</i> [:] [/] [<i>DIRECTORY</i>] < <i>stack_member_filename</i> > < <i>stack_master_filename</i> >

Note  When the flash base directory is required for local file systems (**flash**, **nvs**, and **card**) you may use **flash** or **flash:** or **flash:/** and similarly when the SD (or SDHC) card base directory is required you may use **card** or **card:** or **card:/**

The keywords **flash**, **nvs**, **card**, **tftp**, **scp**, **sftp** and **http** are reserved for tab completion when using the **copy**, **move**, **delete**, **cd**, and **dir** commands.

Keywords **flash**, **nvs**, **card**, **tftp**, **scp**, **sftp** and **http** cannot be applied as directory or subdirectory names when using a **mkdir** command.

A leading slash (/) indicates the root of the current filesystem location.

Command List

boot backup

This command specifies a backup release file to load during the next boot cycle. If your device cannot load the main release file, then the file specified with this command is used.

Syntax `boot backup <filename>`

Parameter	Description
<code><filename></code>	Name of a release file. The specified file must exist in the root directory of the flash file system. Valid release files must have a <code>.rel</code> extension.

Mode Global Configuration

Example To set the release file `r1-5.3.3.rel` as the device's backup release, use the command:

```
awplus# configure terminal
awplus(config)# boot backup r1-5.3.3.rel
```

Related Commands [boot config-file](#)
[boot system](#)
[show boot](#)

boot config-file

This command sets the configuration file to use during the next boot cycle.

Syntax `boot config-file <filename>`

Parameter	Description
<code><filename></code>	Name of a configuration file. The specified file must exist in the root directory of the flash file system. Valid configuration files must have a .cfg extension.

Mode Global Configuration

Example To run the configuration file `branch.cfg` the next time the device boots up, use the command:

```
awplus# configure terminal
awplus(config)# boot config-file flash:/branch.cfg
```

Related Commands `boot backup`
`boot system`
`show boot`

boot system

This command specifies the release file to load during the next boot cycle.

Syntax `boot system <filename>`

Parameter	Description
<code><filename></code>	Name of a release file. The specified file must exist in the root directory of the flash file system. Valid release files must have a .rel extension.

Mode Global Configuration

Example To run the release file `r1-5.3.1.rel` the next time the device boots up, use the command:

```
awplus# configure terminal
awplus(config)# boot system r1-5.3.1.rel
```

Related Commands `boot config-file`
`boot backup`
`show boot`

cd

This command changes the current working directory.

Syntax `cd <directory-url>`

Parameter	Description
<code><directory-url></code>	URL of the directory.

Mode Privileged Exec

Example To change to the directory called `images`, use the command:

```
awplus# cd images
```

Related Commands [dir](#)
[pwd](#)
[show file systems](#)

copy current-software

This command copies the AlliedWare Plus™ OS software that the device has booted from to a destination file. Specify whether the destination is Flash or Card when saving the software to the local file system.

Syntax `copy current-software <destination-url>`

Parameter	Description
<code><destination-url></code>	The URL where you would like the current running-release saved. This command creates a file if no file exists with the specified filename. If a file already exists, then the CLI prompts you before overwriting the file. See “URL Syntax and Keyword Usage” on page 7.3 for valid URL syntax.

Mode Privileged Exec

Example To copy the current software as installed in the working directory with the file name `my-release.rel`, use the command:

```
awplus# copy current-software my-release.rel
```

Related Commands [boot system](#)
[show boot](#)

copy debug

This command copies a specified debug file to a destination file. Specify whether the destination is Flash or Card when saving the software to the local file system.

Syntax `copy debug {<destination-url>|card|debug|flash|nvs|scp|tftp}
{<source-url>|card|debug|flash|nvs|scp|tftp}`

Parameter	Description
<code><destination-url></code>	The URL where you would like the debug output saved. See “URL Syntax and Keyword Usage” on page 7.3 for valid URL syntax.
<code><source-url></code>	The URL where the debug output originates. See “URL Syntax and Keyword Usage” on page 7.3 for valid URL syntax.

Mode Privileged Exec

Example To copy debug output to SD (or SDHC) card with a filename `my-debug`, use the following command:

```
awplus# copy debug card:mydebug
```

Output Figure 7-1: CLI prompt after entering the `copy debug` command

```
Enter source file name []:
```

Related Commands `delete debug`
`move debug`

copy (local)

This command copies a file between local file systems. This allows you to copy a file stored on flash memory to or from a different memory type attached to your device, such as an SD (or SDHC) card. By default, the destination filename is the same as the source file.

Syntax `copy <local-source> <local-destination> <filename>`

Parameter	Description
<code><local-source></code>	File system where the original file is stored.
<code>card</code>	Copies the file from an attached SD (or SDHC) card.
<code>flash</code>	Copies the file from Flash memory.
<code><local-destination></code>	File system where the file is copied to.
<code>card</code>	Copies the file from an attached SD (or SDHC) card.
<code>flash</code>	Copies the file to Flash memory.
<code><filename></code>	Filename of the file you are copying.

Mode Privileged Exec

Example To copy the file `newconfig.cfg` onto your device's flash from an SD (or SDHC) Card, use the command:

```
awplus# copy card flash newconfig.cfg
```

Related Commands `copy (URL)`
`copy zmodem`
`show file`
`show file systems`

copy running-config

This command copies the running-config to a destination file, or copies a source file into the running-config. Commands entered in the running-config do not survive a device reboot unless they are saved in a configuration file.

Syntax

```
copy <source-url> running-config
copy running-config <destination-url>
copy running-config startup-config
```

Parameter	Description
<source-url>	The URL of a configuration file. This must be a valid configuration file with a .cfg filename extension. Specify this when you want the script in the file to become the new running-config. The URL can contain the following protocols or location words. See “URL Syntax and Keyword Usage” on page 7.3 for valid URL syntax.
<destination-url>	The URL where you would like the current running-config saved. This command creates a file if no file exists with the specified filename. If a file already exists, then the CLI prompts you before overwriting the file. See “URL Syntax and Keyword Usage” on page 7.3 for valid URL syntax.
startup-config	Copies the running-config into the file set as the current startup-config file.

Mode Privileged Exec

Examples To copy the running-config into the startup-config, use the command:

```
awplus# copy running-config startup-config
```

To copy the file layer3.cfg into the running-config, use the command:

```
awplus# copy layer3.cfg running-config
```

To use SCP to copy the running-config as current.cfg to the remote server listening on TCP port 2000, use the command:

```
awplus# copy running-config scp://user@server:2000/
config_files/current.cfg
```

Related Commands

- [copy startup-config](#)
- [write file](#)
- [write memory](#)

copy startup-config

This command copies the startup-config script into a destination file, or alternatively copies a configuration script from a source file into the startup-config file. Specify whether the destination is flash or card when loading from the local file system.

Syntax `copy <source-url> startup-config`
`copy startup-config <destination-url>`

Parameter	Description
<code><source-url></code>	The URL of a configuration file. This must be a valid configuration file with a <code>.cfg</code> filename extension. Specify this to copy the script in the file into the <code>startup-config</code> file. Note that this does not make the copied file the new startup file, so any further changes made in the configuration file are not added to the startup-config file unless you reuse this command. See “URL Syntax and Keyword Usage” on page 7.3 for valid URL syntax.
<code><destination-url></code>	The destination and filename that you are saving the startup-config as. This command creates a file if no file exists with the specified filename. If a file already exists, then the CLI prompts you before overwriting the file. See “URL Syntax and Keyword Usage” on page 7.3 for valid URL syntax.

Mode Privileged Exec

Examples To copy the file `Layer3.cfg` to the `startup-config`, use the command:

```
awplus# copy Layer3.cfg startup-config
```

To copy the `startup-config` as the file `oldconfig.cfg` in the current directory, use the command:

```
awplus# copy startup-config oldconfig.cfg
```

Related Commands [copy running-config](#)

copy (URL)

This command copies a file. This allows you to:

- copy files from your device to a remote device
- copy files from a remote device to your device
- copy files stored on flash memory to or from a different memory type, such as an SD (or SDHC) card
- create two copies of the same file on your device

Syntax `copy <source-url> <destination-url>`

Parameter	Description
<code><source-url></code>	The URL of the source file. See “URL Syntax and Keyword Usage” on page 7.3 for valid URL syntax.
<code><destination-url></code>	The URL for the destination file. See “URL Syntax and Keyword Usage” on page 7.3 for valid URL syntax.

Mode Privileged Exec

Examples To use TFTP to copy the file `bob.key` into the current directory from the remote server at `10.0.0.1`, use the command:

```
awplus# copy tftp://10.0.0.1/bob.key bob.key
```

To use SFTP to copy the file `new.cfg` into the current directory from a remote server at `10.0.1.2`, use the command:

```
awplus# copy sftp://10.0.1.2/new.cfg bob.key
```

To use SCP with the username `beth` to copy the file `old.cfg` into the directory `config_files` on a remote server that is listening on TCP port 2000, use the command:

```
awplus# copy scp://beth@serv:2000/config_files/old.cfg old.cfg
```

To copy the file `config.cfg` into the current directory from an SD (or SDHC) Card, and rename it to `configtest.cfg`, use the command:

```
awplus# copy card:/config.cfg configtest.cfg
```

Stacked Devices In a stacked environment you can use the CLI on a stack master to access file systems that are located on another stack member. In this case, when you enter the command, specify the stack member's file system by using the following syntax:

```
<hostname>-<member-id>/
```

(for example, `awplus-1/` for a file or directory on stack member 1, `awplus-2/` for member 2 etc).

Example To copy the file `test.txt` from the top level of Flash on stack member 4 to the current directory in the stack master, use the command:

```
awplus# copy awplus-4/flash:/test.txt test.txt
```

Note that you must specify the filesystem on the slave stack member (`flash:` in this example).

Related Commands [copy \(local\)](#)
[copy zmodem](#)
[show file systems](#)

copy zmodem

This command allows you to copy files using ZMODEM using Minicom. ZMODEM works over a serial connection and does not need any interfaces configured to do a file transfer.

Syntax `copy <source-url> zmodem`
`copy zmodem`

Parameter	Description
<code><source-url></code>	The URL of the source file. See “URL Syntax and Keyword Usage” on page 7.3 for valid URL syntax.

Mode Privileged Exec

Example To copy the local file `asuka.key` using ZMODEM, use the command:

```
awplus# copy asuka.key zmodem
```

Related Commands [copy \(local\)](#)
[copy \(URL\)](#)
[show file systems](#)

delete

This command deletes files or directories.

Syntax `delete [force] [recursive] <url>`

Parameter	Description
<code>force</code>	Ignore nonexistent filenames and never prompt before deletion.
<code>recursive</code>	Remove the contents of directories recursively.
<code><url></code>	URL of the file to delete. See “URL Syntax and Keyword Usage” on page 7.3 for valid URL syntax.

Mode Privileged Exec

Examples To delete the file `temp.cfg` from the current directory, use the command:

```
awplus# delete temp.cfg
```

To delete the read-only file `one.cfg` from the current directory, use the command:

```
awplus# delete force one.cfg
```

To delete the directory `old_configs`, which is not empty, use the command:

```
awplus# delete recursive old_configs
```

To delete the directory `new_configs`, which is not empty, without prompting if any read-only files are being deleted, use the command:

```
awplus# delete force recursive new_configs
```

Related Commands [erase startup-config](#)
[rmdir](#)

delete debug

Use this command to delete a specified debug output file.

Syntax `delete debug <source-url>`

Parameter	Description
<code><source-url></code>	The URL where the debug output originates. See “URL Syntax and Keyword Usage” on page 7.3 for valid URL syntax.

Mode Privileged Exec

Example To delete debug output, use the following command:

```
awplus# delete debug
```

Output Figure 7-2: CLI prompt after entering the **delete debug** command

```
Enter source file name []:
```

Related Commands [copy debug](#)
[move debug](#)

dir

This command lists the files on a filesystem. If no directory or file is specified then this command lists the files in the current working directory.

Syntax `dir [all] [recursive] [<url>|flash|nvs|card|debug]`

Parameter	Description
<code>all</code>	List all files.
<code>recursive</code>	List the contents of directories recursively.
<code><url></code>	URL of the directory or file. If no directory or file is specified, then this command lists the files in the current working directory.
<code>flash</code>	Flash memory root directory
<code>nvs</code>	NVS memory root directory
<code>card</code>	SD (or SDHC) card root directory
<code>debug</code>	Debug root directory

Mode Privileged Exec

Usage In a stacked environment you can use the CLI on a stack master to access file systems that are located on another stack member. In this case, when you enter the command, specify the stack member's file system by using the following syntax:
`<hostname>-<member-id>/`
 (for example, `awplus-1/` for a file or directory on stack member 1, `awplus-2/` for member 2 etc).

Examples To list the files in the current working directory, use the command:

```
awplus# dir
```

To list the non-hidden files in the root of the Flash filesystem, use the command:

```
awplus# dir flash
```

To list all the files in the root of the Flash filesystem, use the command:

```
awplus# dir all flash:
```

To list recursively the files in the Flash file system, use the command:

```
awplus# dir recursive flash:
```

To list the files within the flash file system for stack member 3, use the command:

```
awplus# dir awplus-3/flash:/
```

Note that you must specify the filesystem on the stack member (`flash` in this example).

Related Commands [cd](#)
[pwd](#)

edit

This command opens a text file in the AlliedWare Plus™ text editor. Once opened you can use the editor to alter to the file.

If a filename is specified and it already exists, then the editor opens it in the text editor.

If no filename is specified, the editor prompts you for one when you exit it.

Before starting the editor make sure your terminal, terminal emulation program, or Telnet client is 100% compatible with a VT100 terminal. The editor uses VT100 control sequences to display text on the terminal.

For more information about using the editor, including control sequences, see [“Using the editor” on page 6.6.](#)

Syntax `edit [<filename>]`

Parameter	Description
<code><filename></code>	Name of a file in the local flash file system.

Mode Privileged Exec

Examples To create and edit a new text file, use the command:

```
awplus# edit
```

To edit the existing configuration file `myconfig.cfg` stored on your device's flash memory, use the command:

```
awplus# edit myconfig.cfg
```

Related Commands [edit URL](#)
[show file](#)

edit URL

This command opens a remote text file as read-only in the AlliedWare Plus™ text editor.

Before starting the editor make sure your terminal, terminal emulation program, or Telnet client is 100% compatible with a VT100 terminal. The editor uses VT100 control sequences to display text on the terminal.

Syntax `edit <url>`

Parameter	Description
<code><url></code>	The URL of the remote file. See “URL Syntax and Keyword Usage” on page 7.3 for valid URL syntax.

Mode Privileged Exec

Example To view the file `bob.key` stored in the security directory of a TFTP server, use the command:

```
awplus# edit tftp://security/bob.key
```

Related Commands [edit](#)
[show file](#)

erase startup-config

This command deletes the file that is set as the startup-config file, which is the configuration file that the system runs when it boots up.

At the next restart, the device loads the default configuration file, `default.cfg`. If `default.cfg` no longer exists, then the device loads with the factory default configuration. This provides a mechanism for you to return the device to the factory default settings.

Syntax `erase startup-config`

Mode Privileged Exec

Example To delete the file currently set as the startup-config, use the command:

```
awplus# erase startup-config
```

Related Commands [boot backup](#)
[boot config-file](#)
[copy running-config](#)
[copy startup-config](#)
[show boot](#)

license

These commands enable or disable the specified licensed software feature set. For feature licenses, contact your authorized distributor or reseller.

If a license key expires or a proper key is not installed, some software features will not be available.

Note  See the AlliedWare Plus™ datasheet for a list of current feature licenses available by product, and the AlliedWare Plus™ How To notes for information on obtaining them.

Syntax `license <name> <key>`
`no license [<name>|index <index-number>]`

Parameter	Description
<code><name></code>	The license name of the software feature. To display enabled license names, use the show license command. The default license names are issued with encrypted keys that enable the features. Default names can be changed but must be 15 characters or less.
<code><key></code>	The encrypted license key to enable this software feature.
<code><index-number></code>	The index number of the software feature. To display the index number, use the show license command.

Mode Privileged Exec

Usage Default feature license names are issued along with encrypted license keys by email for you to apply using this command to enable features. These default feature license names can be changed, but must be 15 characters or less in length to be accepted with the issued key.

For example, you may want to change the license name 'AT-FL-SBX9-01' to 'x900 L3 license'. The license name and license index is displayed with the [show license command on page 7.27](#).

Related Commands [show license](#)

mkdir

This command makes a new directory.

Syntax `mkdir <url>`

Parameter	Description
<code><url></code>	URL of the directory that you are creating.

Mode Privileged Exec

Usage The keywords **flash**, **nvs**, **card**, **tftp**, **scp**, **sftp** and **http** are reserved for tab completion when using the **copy**, **move**, **delete**, **cd** and **dir** command. Keywords **flash**, **nvs**, **card**, **tftp**, **scp**, **sftp** and **http** cannot be applied as directory or subdirectory names when using a **mkdir** command.

Example To make a new directory called **images** in the current directory, use the command:

```
awplus# mkdir images
```

Related Commands `cd`
`dir`
`pwd`

move

This command renames or moves a file.

Syntax `move <source-url> <destination-url>`

Parameter	Description
<code><source-url></code>	The URL of the source file. See “URL Syntax and Keyword Usage” on page 7.3 for valid URL syntax.
<code><destination-url></code>	The URL of the destination file. See “URL Syntax and Keyword Usage” on page 7.3 for valid URL syntax.

Mode Privileged Exec

Examples To rename the file `temp.cfg` to `startup.cfg`, use the command:

```
awplus# move temp.cfg startup.cfg
```

To move the file `temp.cfg` from the root of the flash filesystem to the directory `myconfigs`, use the command:

```
awplus# move temp.cfg myconfigs/temp.cfg
```

Related Commands [delete](#)
[edit](#)
[show file](#)
[show file systems](#)

move debug

This command moves a specified debug file to a destination debug file. Specify whether the destination is Flash or Card when saving the software to the local file system.

Syntax `move debug {<destination-url>|card|debug|flash|nvs}
{<source-url>|card|debug|flash|nvs}`

Parameter	Description
<code><destination-url></code>	The URL where you would like the debug output moved to. See “URL Syntax and Keyword Usage” on page 7.3 for valid URL syntax.
<code><source-url></code>	The URL where the debug output originates. See “URL Syntax and Keyword Usage” on page 7.3 for valid URL syntax.

Mode Privileged Exec

Example To move debug output onto a SD (or SDHC) card with a filename `my-debug`, use the following command:

```
awplus# move debug card:my-debug
```

Output Figure 7-3: CLI prompt after entering the **move debug** command

```
Enter source file name []:
```

Related Commands [copy debug](#)
[delete debug](#)

pwd

This command prints the current working directory.

Syntax `pwd`

Mode Privileged Exec

Example To print the current working directory, use the command:

```
awplus# pwd
```

Related Commands [cd](#)

rmdir

This command removes a directory. The directory must be empty for the command to work unless the optional **force** keyword is used to remove all subdirectories or files in a directory.

Syntax `rmdir [force] <url>`

Parameter	Description
<code>force</code>	Optional keyword that allows you to delete any directories that are not empty and may contain files or subdirectories.
<code><url></code>	The URL of the directory.

Mode Privileged Exec

Usage In a stacked environment you can use the CLI on a stack master to access file systems that are located on another stack member. In this case, when you enter the command, specify the stack member's file system by using the following syntax:
`<hostname>--<member-id>/`
 (for example, `awplus-1/` for a file or directory on stack member 1, `awplus-2/` for member 2 etc).

Examples To remove the directory `images` from the top level of the Flash file system, use the command:

```
awplus# rmdir flash:/images
```

To force the removal of directory `level1` containing subdirectory `level2`, use the command:

```
awplus# mkdir level1
awplus# mkdir level1/level2
awplus# rmdir force level1
```

To remove a directory called `test` from the top level of the Flash filesystem in stack member 3, use the command:

```
awplus# rmdir awplus-3/flash:/test
```

Note that you must specify the filesystem ("flash:" in this example).

Related Commands [cd](#)
[dir](#)
[mkdir](#)
[pwd](#)

show boot

This command displays the current boot configuration.

Syntax `show boot`

Mode Privileged Exec

Example To show the current boot configuration, use the command:

```
awplus# show oldconfig.cfg
```

Output Figure 7-4: Example output from the **show boot** command

```

Boot configuration
-----
Current software   : r1-5.3.1.rel
Current boot image : flash:/r1-5.3.1.rel
Backup boot image  : flash:/r1-5.2.2.rel
Default boot config: flash:/default.cfg
Current boot config: flash:/my.cfg (file exists)

```

Table 7-1: Parameters in the output of the **show boot** command

Parameter	Description
Current software	The current software release that the device is using.
Current boot image	The boot image currently configured for use during the next boot cycle.
Backup boot image	The boot image to use during the next boot cycle if the device cannot load the main image.
Default boot config	The default start up configuration file. The device loads this configuration script if no file is set as the start up-config file.
Current boot config	The configuration file currently configured as the start up-config file. The device loads this during the next boot cycle.

Related Commands [boot backup](#)
[boot config-file](#)
[boot system](#)

show file

This command displays the contents of a specified file.

Syntax `show {<filename> | <url>}`

Parameter	Description
<code><filename></code>	Name of a file on the local Flash file system.
<code><url></code>	URL of a file.

Mode Privileged Exec

Example To display the contents of the file `oldconfig.cfg`, which is in the current directory, use the command:

```
awplus# show oldconfig.cfg
```

Related Commands [edit](#)
[edit URL](#)
[show file systems](#)

show file systems

This command lists the file systems and their utilization information where appropriate.

If this command is entered on the stack master, it will list the file systems for all the stack members. A stack member heading is displayed to distinguish the different lists shown for each stack member. If it is entered on a specific stack member, as a host-directed command, it will list the file systems for only that stack member.

Syntax `show file systems`

Mode Privileged Exec

Examples To display the file systems for either a standalone device, or a complete stack, use the command:

```
awplus# show file systems
```

To list the file system for stack member 3, use the command:

```
awplus# remote-command 3 show file systems
```

Output Figure 7-5: Example output from the **show file systems** command

```

STACK member 1:
  Size(B)  Free(B)  Type  Flags  Prefixes  S/D/V  Lcl/Ntwk
  Avail
-----
  30.0M    6.7M    flash  rw  flash:    static  local    Y
  -        -        system  rw  system:   virtual local    -
  499.0k   0        nvs    rw  nvs:     static  local    Y
  -        -        sdcard  rw  card:    dynamic local    N
  -        -        tftp    rw  tftp:    -       network  -
  -        -        scp     rw  scp:     -       network  -
  -        -        sftp    ro  sftp:    -       network  -
  -        -        http    ro  http:    -       network  -
-----

STACK member 2:
  Size(B)  Free(B)  Type  Flags  Prefixes  S/D/V  Lcl/Ntwk
  Avail
-----
  30.0M    6.7M    flash  rw  flash:    static  local    Y
  -        -        system  rw  system:   virtual local    -
  499.0k   0        nvs    rw  nvs:     static  local    Y
  -        -        sdcard  rw  card:    dynamic local    N
  -        -        tftp    rw  tftp:    -       network  -
  -        -        scp     rw  scp:     -       network  -
  -        -        sftp    ro  sftp:    -       network  -
  -        -        http    ro  http:    -       network  -
.
.
.

```

Table 7-2: Parameters in the output of the **show file systems command**

Parameter	Description
Size (B) Available	The total memory available to this file system. The units are given after the value and are M for Megabytes or k for kilobytes.
Free (B)	The total memory free within this file system. The units are given after the value and are M for Megabytes or k for kilobytes.
Type	The memory type used for this file system: flash, system, nvs, sdcard, tftp, scp, sftp, or http.
Flags	The file setting options: rw (read write), ro (read only).
Prefixes	The prefixes used when entering commands to access the file systems: flash, system, nvs, sdcard, tftp, scp, sftp, or http.
S/V/D	The memory type: static, virtual, dynamic.
Lcl / Ntwk	Whether the memory is located locally or via a network connection.
Y / N	Whether the memory is accessible: Y (yes), N (no), - (not appropriate)

Related Commands

- [edit](#)
- [edit URL](#)
- [show file](#)

show license

This command displays license information about a specified licensed software feature, or all enabled software feature licenses.

Syntax `show license [<name>|index <index-number>] [brief]`

Parameter	Description
<name>	The license name of the software feature to show information about.
<index-number>	The index number of the software feature to display information about.
brief	Displays a brief summary of license information.

Mode User Exec and Privileged Exec

Examples To display a brief summary of information about all enabled licenses, use the command:

```
awplus# show license brief
```

To display full information about all enabled licenses, use the command:

```
awplus# show license
```

To display full information about the licenses with index number 1, use the command:

```
awplus# show license index 1
```

Output Figure 7-6: Example output from the `show license index` command

```
awplus#show license index 0
Software Feature Licenses
-----
Index                               : 0
License name                         : Base License
Customer name                        : Base License
Quantity of licenses                 : 1
Type of license                       : Full
License issue date                   : 07-Jul-2000
License expiry date                  : N/A
Features include                      : VRRP OSPF-64
```

Figure 7-7: Example output from the **show license brief** command

```
awplus>show license brief
Software Feature Licenses
-----
Index License name      Quantity  Customer name
      Type
-----
0      Base License      1         Base License
      Full              N/A
Current enabled features:
  VRRP
  OSPF-64
```

Table 7-3: Parameters in the output of the **show license** command

Parameter	Description
Index	Index identifying entry
License name	Name of the license key bundle (case-sensitive)
Customer name	Customer name
Quantity of licenses	Quantity of the licenses included in the feature key
Type of license	Full or Temporary
License issue date	Date the key was generated
License expiry date	Expiry date for Temporary feature key
Features include	List of features included in the feature key

Related Commands [license](#)

show running-config

This command displays the current configuration of the device. The output includes all non-default configuration; default settings are not displayed.

You can control the output in any one of the following ways:

- To display only lines that contain a particular word, follow the command with `| include word`
- To start the display at the first line that contains a particular word, follow the command with `| begin word`
- To save the output to a file, follow the command with `> filename`

For more information, see [“Controlling “show” Command Output”](#) on page 1.35.

Syntax `show running-config`

Mode All modes

Example To display the current dynamic configuration of your device, use the command:

```
awplus# show running-config
```

Output Figure 7-8: Example output from the **show running-config** command

```
!  
service password-encryption  
!  
username manager privilege 15 password 8 $1$bJoVec4D$JwOJGPr7YqoExA0GVasdE0  
!  
service telnet  
!  
no clock timezone  
ip domain-lookup  
!  
spanning-tree mode rstp  
no platform e2efc  
!  
interface port1.0.1-1.0.24  
  switchport  
  switchport mode access  
!  
!  
service telnet  
!  
no clock timezone  
!  
!  
stack virtual-mac  
stack virtual-chassis-id 2111  
!  
!  
ip domain-lookup  
!  
spanning-tree mode rstp  
no platform e2efc  
!  
interface port1.0.1-1.0.24  
  switchport  
  switchport mode access  
!  
interface vlan2  
  ip address 172.28.8.210/16  
!  
ip route 0.0.0.0/0 172.28.0.1  
!  
line con 0  
line vty 0 4  
!  
end
```

Related Commands [copy running-config](#)
[show running-config access-list](#)

show running-config access-list

Use this command to show the running system status and configuration details for access-list.

For information on output options, see [“Controlling “show” Command Output” on page 1.35.](#)

Syntax `show running-config access-list`

Mode Privileged Exec and Global Configuration

Example To display the running system status and configuration details for access-list, use the command:

```
awplus# show running-config access-list
```

Output Figure 7-9: Example output from the `show running-config access-list` command

```
!  
access-list abc remark annai  
access-list abc deny any  
access-list abd deny any  
!
```

Related Commands `copy running-config`
`show running-config`

show running-config as-path access-list

Use this command to show the running system status and configuration details for as-path access-list.

For information on output options, see [“Controlling “show” Command Output” on page 1.35.](#)

Syntax `show running-config as-path access-list`

Mode Privileged Exec and Global Configuration

Example To display the running system status and configuration details for as-path access-list, use the command:

```
awplus# show running-config as-path access-list
```

Output Figure 7-10: Example output from the `show running-config as-path access-list` command

```
!  
ip as-path access-list wer permit knsmk  
!
```

Related Commands `copy running-config`
`show running-config`

show running-config bgp

Use this command to show the running system BGP related configuration.

For information on output options, see [“Controlling “show” Command Output” on page 1.35.](#)

Syntax show running-config bgp

Mode Privileged Exec and Global Configuration

Example To display the running system BGP related configuration, use the command:

```
awplus# show running-config bgp
```

Output Figure 7-11: Example output from the **show running-config bgp** command

```
!  
bgp config-type standard  
bgp rfc1771-path-select  
bgp rfc1771-strict  
bgp aggregate-nexthop-check  
!  
router bgp 1  
no auto-summary  
no synchronization  
bgp router-id 1.2.3.4  
!
```

Related Commands copy running-config
show running-config

show running-config community-list

Use this command to show the running system status and configuration details for community-lists.

For information on output options, see [“Controlling “show” Command Output” on page 1.35.](#)

Syntax show running-config community-list

Mode Privileged Exec and Global Configuration

Example To display the running system status and configuration details for community-lists use the command:

```
awplus# show running-config community-list
```

Output Figure 7-12: Example output from the **show running-config community list** command

```
!
ip community-list standard aspd permit internet
ip community-list expanded cspd deny ljj
ip community-list expanded cspd permit dcv
ip community-list expanded wde permit njhd
ip community-list expanded wer deny sde
```

Related Commands [copy running-config](#)
[show running-config](#)

show running-config dhcp

Use this command to display the running configuration for DHCP server, DHCP relay, and DHCP snooping.

Syntax `show running-config dhcp`

Mode Privileged Exec and Global Configuration

Example To display to display the running configuration for DHCP server, DHCP relay, and DHCP snooping, use the command:

```
awplus# show running-config dhcp
```

Output Figure 7-13: Example output from the `show running-config dhcp` command

```
!  
#show running-config dhcp  
no service dhcp-server  
!  
service dhcp-snooping  
!  
interface port1.0.1  
  ip dhcp snooping trust  
!  
interface port1.0.21  
  ip dhcp snooping max-bindings 25  
  access-group dhcpsnooping  
!  
interface port2.0.21  
  ip dhcp snooping max-bindings 25  
  access-group dhcpsnooping  
!  
interface port2.0.44  
  access-group dhcpsnooping  
!  
interface port3.0.1  
  ip dhcp snooping trust  
!  
interface port3.0.21  
  ip dhcp snooping max-bindings 25  
!  
interface port4.0.24  
  access-group dhcpsnooping  
!  
interface po1  
  ip dhcp snooping max-bindings 25  
  arp security violation log  
!  
interface sa1  
  ip dhcp snooping max-bindings 25  
  access-group dhcpsnooping  
  arp security violation log  
!  
interface vlan100  
  ip dhcp snooping  
  arp security  
!  
interface vlan200  
  ip dhcp snooping  
  arp security  
!
```

Related Commands [copy running-config](#)
[show running-config](#)

show running-config full

Use this command to show the complete status and configuration of the running system.

For information on output options, see [“Controlling “show” Command Output” on page 1.35.](#)

Syntax show running-config full

Mode Privileged Exec and Global Configuration

Example To display the complete status and configuration of the running system, use the command:

```
awplus# show running-config full
```

Output Figure 7-14: Example output from the **show running-config full** command

```
!
no service password-encryption
!
interface lo
ip address 127.0.0.1/8
ipv6 address ::1/128
!
interface vlan1
ip address 10.92.0.16/24
ipv6 address fe80::202:b3ff:fea1:2159/64
!
interface vlan2
ip address 20.10.10.54/24
ipv6 address fe80::200:5eff:fe00:101/64
ipv6 address fe80::202:b3ff:fea1:1567/64
ipv6 address fe80::204:76ff:fee6:6c1c/64
ip rip authentication string abcdefghijklmnop
!
router ospf
ospf router-id 100.100.100.100
no capability opaque
redistribute static
network 10.10.10.0/24 area 3
network 10.10.11.0/24 area 1
network 10.10.16.0/24 area 2
network 192.168.0.0/24 area 1
!
router rip
network vlan2
distance 10
!
router ipv6 rip
!
ip route 5.5.5.0/24 10.10.16.2
!
line con 0
login
line vty 0 4
login
!
end
```

Related Commands [copy running-config](#)
[show running-config](#)

show running-config interface

This command displays the current configuration of one or more interfaces on the switch.

For information on output options, see [“Controlling “show” Command Output” on page 1.35.](#)

Syntax `show running-config interface [<interface-list>]
[dot1x|ip igmp|ip multicast|ip pim dense-mode|ip pim sparse-mode|
ipv6 rip|lacp|mstp|ospf|rip|rstp|stp]`

Parameter	Description
<interface-list>	<p>The interfaces or ports to display information about. An interface-list can be:</p> <ul style="list-style-type: none"> ■ an interface (e.g. <code>vlan2</code>), a switch port (e.g. <code>port1.1.12</code>), a static channel group (e.g. <code>sa3</code>) or a dynamic (LACP) channel group (e.g. <code>po4</code>) ■ a continuous range of interfaces, ports, static channel groups or dynamic (LACP) channel groups separated by a hyphen; e.g. <code>vlan2-8</code>, or <code>port1.1.1-1.1.24</code>, or <code>sa2-4</code>, or <code>po1-3</code> ■ a comma-separated list of the above; e.g. <code>port1.0.1,port1.1.1-1.2.24</code>. Do not mix interface types in a list. <p>The specified interfaces must exist.</p>
<code>dot1x</code>	displays running configuration for 802.1X port authentication for the specified interfaces.
<code>lacp</code>	displays running configuration for LACP (Link Aggregation Control Protocol) for the specified interfaces.
<code>ip igmp</code>	displays running configuration for IGMP (Internet Group Management Protocol) for the specified interfaces.
<code>ip multicast</code>	displays running configuration for general multicast settings for the specified interfaces.
<code>ip pim sparse-mode</code>	displays running configuration for PIM-SM (Protocol Independent Multicast - Sparse Mode) for the specified interfaces.
<code>ip pim dense-mode</code>	displays running configuration for PIM-DM (Protocol Independent Multicasting - Dense Mode) for the specified interfaces.
<code>mstp</code>	displays running configuration for MSTP (Multiple Spanning Tree Protocol) for the specified interfaces.
<code>ospf</code>	displays running configuration for OSPF (Open Shortest Path First) for the specified interfaces.
<code>rip</code>	displays running configuration for RIP (Routing Information Protocol) for the specified interfaces.
<code>ipv6 rip</code>	displays running configuration for RIPng (RIPng for IPv6) for the specified interfaces.

Parameter (cont.)	Description (cont.)
<code>rstp</code>	displays running configuration for RSTP (Rapid Spanning Tree Protocol) for the specified interfaces.
<code>stp</code>	displays running configuration for STP (Spanning Tree Protocol) for the specified interfaces.

Mode Privileged Exec

Examples To display current running configuration of your switch for ports 1 to 24, use the command:

```
awplus# show running-config interface port1.0.1-port1.0.24
```

To display current running configuration of a switch for VLAN 1, use the command:

```
awplus# show running-config interface vlan1
```

To display current running configuration of a switch for VLANs 1 and 3-5, use the command:

```
awplus# show running-config interface vlan1,vlan3-vlan5
```

To display current OSPF configuration of your switch for ports 1 to 24, use the command:

```
awplus# show running-config interface port1.0.1-port1.0.24
ospf
```

To display current IGMP configuration for ports 1 to 12 on XEM 1 and 3, use the command:

```
awplus# show running-config interface port1.0.1-
1.0.12,port1.3.1-1.3.12 ip igmp
```

Output Figure 7-15: Example output from a **show running-config interface port1.0.2** command

```
awplus#sh running-config interface port1.0.2
!
interface port1.0.2
 switchport
 switchport mode access
!
```

Figure 7-16: Example output from the **show running-config interface** command

```
awplus#sh running-config interface
interface port1.0.1-1.0.24
  switchport
  switchport mode access
!
interface vlan1
  ip address 192.168.1.1/24
  ip rip authentication mode md5
  ip rip authentication string mykey
  ip irdp
!
interface vlan2
  ip address 192.168.2.2/24
  ip rip authentication mode md5
  ip rip authentication key-chain cars
```

Related Commands [copy running-config](#)
[show running-config](#)

show running-config ip pim dense-mode

Use this command to show the running system status and configuration details for PIM-DM.

For information on output options, see [“Controlling “show” Command Output” on page 1.35.](#)

Syntax `show running-config ip pim dense-mode`

Mode Privileged Exec and Global Configuration

Example To display the running system status and configuration details for PIM-DM, use the command:

```
awplus# show running-config ip pim dense-mode
```

Output Figure 7-17: Example output from the `show running-config ip pim dense-mode` command

```
!  
ip pim spt-threshold  
ip pim accept-register list 1  
!
```

Related Commands [copy running-config](#)
[show running-config](#)

show running-config ip pim sparse-mode

Use this command to show the running system status and configuration details for PIM-SM.

For information on output options, see [“Controlling “show” Command Output” on page 1.35.](#)

Syntax `show running-config ip pim sparse-mode`

Mode Privileged Exec and Global Configuration

Example To display the running system status and configuration details for PIM-SM, use the command:

```
awplus# show running-config ip pim sparse-mode
```

Output Figure 7-18: Example output from the `show running-config ip pim sparse-mode` command

```
!  
ip pim spt-threshold  
ip pim accept-register list 1  
!
```

Related Commands [copy running-config](#)
[show running-config](#)

show running-config ip route

Use this command to show the running system static IPv4 route configuration.

For information on output options, see [“Controlling “show” Command Output” on page 1.35.](#)

Syntax `show running-config ip route`

Mode Privileged Exec and Global Configuration

Example To display the running system static IPv4 route configuration, use the command:

```
awplus# show running-config ip route
```

Output Figure 7-19: Example output from the `show running-config ip route` command

```
!  
ip route 3.3.3.3/32 vlan3  
ip route 3.3.3.3/32 vlan2  
!
```

Related Commands `copy running-config`
`show running-config`

show running-config ipv6 access-list

Use this command to show the running system status and configuration for ipv6 access-list.

For information on output options, see [“Controlling “show” Command Output” on page 1.35.](#)

Syntax `show running-config ipv6 access-list`

Mode Privileged Exec and Global Configuration

Example To display the running system status and configuration for ipv6 access-list, use the command:

```
awplus# show running-config ipv6 access-list
```

Output Figure 7-20: Example output from the `show running-config ipv6 access-list` command

```
!  
ipv6 access-list abc permit any  
!
```

Related Commands `copy running-config`
`show running-config`

show running-config ipv6 mroute

Use this command to show the running system IPv6 multicast route configuration.

For information on output options, see [“Controlling “show” Command Output”](#) on page 1.35.

Syntax `show running-config ipv6 mroute`

Mode Privileged Exec and Global Configuration

Example To display the running system IPv6 multicast route configuration, use the command:

```
awplus# show running-config ipv6 mroute
```

Output Figure 7-21: Example output from the `show running-config ipv6 mroute` command

```
!  
ipv6 route 3e11::/64 lo  
ipv6 route 3e11::/64 vlan2  
ipv6 route fe80::/64 vlan3  
!
```

Related Commands `copy running-config`
`show running-config`

show running-config ipv6 prefix-list

Use this command to show the running system status and configuration details for ipv6 prefix-list.

For information on output options, see [“Controlling “show” Command Output” on page 1.35.](#)

Syntax `show running-config ipv6 prefix-list`

Mode Privileged Exec and Global Configuration

Example To display show the running system status and configuration details for ipv6 prefix-list, use the command:

```
awplus# show running-config ipv6 prefix-list
```

Output Figure 7-22: Example output from the `show running-config ipv6 prefix-list` command

```
!  
ipv6 prefix-list sde seq 5 permit any  
!
```

Related Commands `copy running-config`
`show running-config`

show running-config ipv6 route

Use this command to show the running system static IPv6 route configuration.

For information on output options, see [“Controlling “show” Command Output” on page 1.35.](#)

Syntax `show running-config ipv6 route`

Mode Privileged Exec and Global Configuration

Example To display the running system static IPv6 route configuration, use the command:

```
awplus# show running-config ipv6 route
```

Output Figure 7-23: Example output from the `show running-config ipv6 route` command

```
!  
ipv6 route 3e11::/64 lo  
ipv6 route 3e11::/64 vlan2  
ipv6 route fe80::/64 vlan3  
!
```

Related Commands `copy running-config`
`show running-config`

show running-config key chain

Use this command to show the running system key-chain related configuration.

For information on output options, see [“Controlling “show” Command Output”](#) on page 1.35.

Syntax show running-config key chain

Mode Privileged Exec and Global Configuration

Example To display the running system key-chain related configuration, use the command:

```
awplus# show running-config key chain
```

Output Figure 7-24: Example output from the **show running-config key chain** command

```
!  
key chain 12  
key 2  
key-string 234  
!  
key chain 123  
key 3  
key-string 345  
!
```

Related Commands copy running-config
show running-config

show running-config lldp

This command shows the current running configuration of LLDP.

Syntax `show running-config lldp`

Mode Privileged Exec

Example To display the current configuration of LLDP, use the command:

```
awplus# show running-config lldp
```

Output Figure 7-25: Example output from the `show running-config lldp` command

```
awplus#show running-config lldp
lldp notification-interval 10
lldp timer 20
!
interface port1.0.1
  lldp notifications
  lldp tlv-select port-description
  lldp tlv-select system-name
  lldp tlv-select system-description
  lldp tlv-select management-address
  lldp transmit receive
```

Related Commands [show lldp](#)
[show lldp interface](#)

show running-config prefix-list

Use this command to show the running system status and configuration details for prefix-list.

For information on output options, see [“Controlling “show” Command Output” on page 1.35.](#)

Syntax `show running-config prefix-list`

Mode Privileged Exec and Global Configuration

Example To display the running system status and configuration details for prefix-list, use the command:

```
awplus# show running-config prefix-list
```

Output Figure 7-26: Example output from the `show running-config prefix-list` command

```
!  
ip prefix-list abc seq 5 permit any  
ip prefix-list as description annal  
ip prefix-list wer seq 45 permit any  
!
```

Related Commands `copy running-config`
`show running-config`

show running-config route-map

Use this command to show the running system status and configuration details for route-map.

For information on output options, see [“Controlling “show” Command Output” on page 1.35.](#)

Syntax show running-config route-map

Mode Privileged Exec and Global Configuration

Example To display the running system status and configuration details for route-map, use the command:

```
awplus# show running-config route-map
```

Output Figure 7-27: Example output from the **show running-config route-map** command

```
!  
route-map abc deny 2  
match community 2  
!  
route-map abc permit 3  
match route-type external type-2  
set metric-type type-1  
!
```

Related Commands copy running-config
show running-config

show running-config router

Use the show running-config router command to display the current running configuration for a given router.

For information on output options, see [“Controlling “show” Command Output” on page 1.35.](#)

Syntax `show running-config router <protocol>`

Parameter	Description
<code><router-protocol></code>	<code>bgp ospf rip ipv6 rip vrrp</code>
<code>bgp</code>	Border Gateway Protocol (BGP)
<code>ospf</code>	Open Shortest Path First (OSPF)
<code>rip</code>	Routing Information Protocol (RIP)
<code>ipv6 rip</code>	rip IPv6 RIP
<code>vrrp</code>	Virtual Redundancy Routing Protocol (VRRP)

Mode Privileged Exec and Global Configuration

Example To display the current running configuration for a given router, use the command:

```
awplus# show running-config router bgp
```

Output Figure 7-28: Example output from the `show running-config router` command

```
!
router bgp 1
network 172.1.0.0/16
neighbor 10.10.10.1 remote-as 1
!
```

Related Commands [copy running-config](#)
[show running-config](#)

show running-config router-id

Use this command to show the running system global router ID configuration.

For information on output options, see “Controlling “show” Command Output” on page 1.35.

Syntax show running-config router-id

Mode Privileged Exec and Global Configuration

Example To display the running system global router ID configuration, use the command:

```
awplus# show running-config router-id
```

Output Figure 7-29: Example output from the **show running-config router-id** command

```
!  
router-id 3.3.3.3  
!
```

Related Commands copy running-config
show running-config

show running-config security-password

This command displays the configuration settings for the various security-password rules. If a default parameter is used for a security-password rule, therefore disabling that rule, no output is displayed for that feature.

For information on output options, see [“Controlling “show” Command Output” on page 1.35.](#)

Syntax `show running-config security-password`

Mode Privileged Exec and Global Configuration

Example To display the current security-password rule settings in the running-config, use the command:

```
awplus# show running-config security-password
```

Output Figure 7-30: Example output from the **show running-config security-password** command

```
security-password minimum-length 8
security-password minimum-categories 3
security-password history 4
security-password lifetime 30
security-password warning 3
security-password forced-change
```

Related Commands [show security-password configuration](#)
[show security-password user](#)

show running-config switch

Use this command to show the running system status and configuration details for a given switch.

For information on output options, see “Controlling “show” Command Output” on page 1.35.

Syntax `show running-config switch <switch-protocol>`

Parameter	Description
<switch-protocol>	dot1x mstp rstp stp
dot1x	802.1X Port-Based Authentication
mstp	Multiple Spanning Tree Protocol (MSTP)
rstp	Rapid Spanning Tree Protocol (RSTP)
stp	Spanning Tree Protocol (RSTP)

Mode Privileged Exec and Global Configuration

Example To display the running system status and configuration details for a given switch, use the command:

```
awplus# show running-config switch stp
```

Output Figure 7-31: Example output from the `show running-config switch` command

```
!
bridge 6 ageing-time 45
bridge 6 priority 4096
bridge 6 max-age 7
```

Related Commands `copy running-config`
`show running-config`

show running-config switch lacp

Use this command to show the running system LACP related configuration.

For information on output options, see [“Controlling “show” Command Output” on page 1.35.](#)

Syntax `show running-config switch lacp`

Mode Privileged Exec and Global Configuration

Example To display the running system LACP related configuration, use the command:

```
awplus# show running-config switch lacp
```

Output Figure 7-32: Example output from the `show running-config switch lacp` command

```
!  
lacp system-priority 23  
!
```

Related Commands `copy running-config`
`show running-config`

show running-config switch radius-server

Use this command to show the running system radius-server related configuration.

For information on output options, see [“Controlling “show” Command Output” on page 1.35.](#)

Syntax `show running-config switch radius-server`

Mode Privileged Exec and Global Configuration

Example To display the running system radius-server related configuration, use the command:

```
awplus# show running-config switch radius-server
```

Output Figure 7-33: Example output from the `show running-config switch radius-server` command

```
!  
radius-server key abc  
!
```

Related Commands `copy running-config`
`show running-config`

show running-config switch vlan

Use this command to show the running system VLAN related configuration.

For information on output options, see [“Controlling “show” Command Output”](#) on [page 1.35](#).

Syntax show running-config switch vlan

Mode Privileged Exec and Global Configuration

Example To display the running system VLAN related configuration, use the command:

```
awplus# show running-config switch vlan
```

Output Figure 7-34: Example output from the **show running-config switch vlan** command

```
!  
vlan database  
vlan 4 bridge 2 name VLAN0004  
vlan 4 bridge 2 state enable
```

Related Commands copy running-config
show running-config

show startup-config

This command displays the contents of the start-up configuration file, which is the file that the device runs on start-up.

For information on output options, see [“Controlling “show” Command Output” on page 1.35.](#)

Syntax `show startup-config`

Mode Privileged Exec

Example To display the contents of the current start-up configuration file, use the command:

```
awplus# show startup-config
```

Output Figure 7-35: Example output from the `show startup-config` command

```
!  
service password-encryption  
!  
username manager privilege 15 password 8 $1$bJoVec4D$JwOJGPr7YqoExA0GVasdE0  
!  
platform jumboframe  
platform routingratio ipv4andipv6  
!  
service telnet  
!  
no clock timezone  
ip domain-lookup  
.  
.  
end
```

Related Commands `boot config-file`
`copy running-config`
`copy startup-config`
`erase startup-config`
`show boot`

show version

This command displays the version number and copyright details of the current AlliedWare Plus™ OS your device is running.

For information on output options, see [“Controlling “show” Command Output” on page 1.35.](#)

Syntax show version

Mode User Exec and Privileged Exec

Example To display the version details of your currently installed software, use the command:

```
awplus# show version
```

Output [Figure 7-36: Example output from the show version command](#)

```
AlliedWare Plus (TM) 5.2.2 06/06/08 00:47:48

Build name : r1-5.2.2-20080606-1.rel
Build date : Mon Aug 6 00:47:48 NZST 2008
Build type : RELEASE

NET-SNMP SNMP agent software
(c) 1989, 1991, 1992 by Carnegie Mellon University;
(c) 1996, 1998-2000 The Regents of the University of California.
All Rights Reserved;
(c) 2001, Networks Associates Technology, Inc. All rights reserved;
(c) 2001, Cambridge Broadband Ltd. All rights reserved.
RSA Data Security, Inc. MD5 Message-Digest Algorithm
(c) 1991-2, RSA Data Security, Inc. Created 1991. All rights reserved.
Libedit Library
(c) 1992, 1993 The Regents of the University of California. All rights reserved.
OpenSSL Library
Copyright (C) 1998-2002 The OpenSSL Project. All rights reserved.
Original SSLeay License
Copyright (C) 1995-1998 Eric Young (eay@cryptsoft.com)
```

Related Commands [boot system](#)
[show boot](#)

write file

This command copies the running-config into the file that is set as the current startup-config file. This command is a synonym of the **write memory** and **copy running-config startup-config** commands.

Syntax write [file]

Mode Privileged Exec

Example To write configuration data to the start-up configuration file, use the command:

```
awplus# write file
```

Related Commands [copy running-config](#)
[write memory](#)
[show running-config](#)

write memory

This command copies the running-config into the file that is set as the current startup-config file. This command is a synonym of the **write file** and **copy running-config startup-config** commands.

Syntax write [memory]

Mode Privileged Exec

Example To write configuration data to the start-up configuration file, use the command:

```
awplus# write memory
```

Related Commands [copy running-config](#)
[write file](#)
[show running-config](#)

write terminal

This command displays the current configuration of the device. This command is a synonym of the [show running-config](#) command.

Syntax write terminal

Mode Privileged Exec

Example To display the current configuration of your device, use the command:

```
awplus# write terminal
```

Related Commands [show running-config](#)

Chapter 8: System Configuration and Monitoring Commands

Command List	8.2
banner exec	8.2
banner login (system)	8.4
banner motd	8.5
boot system (file-path URL)	8.6
clock set	8.7
clock summer-time date	8.8
clock summer-time recurring	8.10
clock timezone	8.12
debug nsm	8.13
debug nsm packet	8.13
diagnostic monitor pcsping	8.14
hostname	8.17
no debug all	8.18
max-fib-routes	8.18
max-static-routes	8.19
show clock	8.20
show cpu	8.21
show cpu history	8.25
show debugging	8.27
show debugging nsm	8.28
show diagnostic monitor pcsping	8.29
show memory	8.30
show memory allocations	8.32
show memory history	8.34
show memory pools	8.36
show nsm client	8.37
show process	8.37
show router-id	8.39
show system	8.40
show system environment	8.42
show system interrupts	8.43
show system pci device	8.44
show system pci tree	8.45
show system pluggable	8.46
show system pluggable detail	8.47
show system psu	8.49
show system serialnumber	8.51
show tech-support	8.52
speed (async)	8.55
system territory	8.56
terminal monitor	8.57
undebug all	8.57
undebug nsm	8.57
undebug nsm packet	8.58

Command List

This chapter provides an alphabetical reference of commands for configuring and monitoring the system.

banner exec

This command configures the User Exec mode banner that is displayed on the console after you login. The **banner exec default** command restores the User Exec banner to the default banner. Use the **no banner exec** command to disable the User Exec banner and remove the default User Exec banner.

Syntax `banner exec <banner-text>`
`banner exec default`
`no banner exec`

Default By default, the AlliedWare Plus™ version and build date is displayed at console login, such as:
`AlliedWare Plus (TM) 5.3.1 07/27/08 00:44:25`

Mode Global Configuration

Examples To configure a User Exec mode banner after login, enter the following commands:

```
awplus#configure terminal
awplus(config)#banner exec enable to move to Priv Exec mode
awplus(config)#exit
awplus#exit

awplus login: manager
Password:
enable to move to Priv Exec mode
awplus>
```

To restore the default User Exec mode banner after login, enter the following commands:

```
awplus#configure terminal
awplus(config)#banner exec default
awplus(config)#exit
awplus#exit

awplus login: manager
Password:
AlliedWare Plus (TM) 5.3.1 11/14/08 13:03:59
awplus>
```

To remove the User Exec mode banner after login, enter the following commands:

```
awplus#configure terminal
awplus(config)#banner exec default
awplus(config)#exit
awplus#exit

awplus login: manager
Password:
awplus>
```

Related Commands [banner login \(system\)](#)
[banner motd](#)

banner login (system)

This command configures the login banner that is displayed on the console when you login. The login banner is displayed on all connected terminals. The login banner is displayed after the MOTD (Message-of-the-Day) banner and before the login username and password prompts.

Use the **no banner login** command to disable the login banner.

Syntax banner login
no banner login

Default By default, no login banner is displayed at console login.

Mode Global Configuration

Examples To configure a login banner to be displayed when you login, enter the following commands:

```
awplus#configure terminal
awplus(config)#banner login
Type CNTL/D to finish.
authorised users only
awplus(config)#exit
awplus#exit

authorised users only
awplus login: manager
Password:

AlliedWare Plus (TM) 5.3.1 11/14/08 13:03:59

awplus>
```

To remove the login banner, enter the following commands:

```
awplus#configure terminal
awplus(config)#no banner login
awplus(config)#exit
awplus#exit

awplus login: manager
Password:

awplus>
```

Related Commands banner exec
banner motd

banner motd

This command displays a text MOTD (Message-of-the-Day) banner on login. The MOTD banner is displayed on all connected terminals. The MOTD banner is useful for sending messages that affect all network users, for example, any imminent system shutdowns.

Use the **no** variant of this command to not display a text MOTD (Message-of-the-Day) banner on login.

Syntax banner motd <motd-text>
no banner motd

Default By default, no motd is displayed at console login.

Mode Global Configuration

Examples To configure a MOTD banner to be displayed when you login, enter the following commands:

```
awplus>enable
awplus#configure terminal
awplus(config)#banner motd system shutdown at 6pm
awplus(config)#exit
awplus#exit

system shutdown at 6pm
awplus login: manager
Password:

AlliedWare Plus (TM) 5.3.1 11/14/08 13:03:59
```

To remove the login banner, enter the following commands:

```
awplus>enable
awplus#configure terminal
awplus(config)#no banner motd
awplus(config)#exit
awplus#exit

awplus login: manager
Password:

AlliedWare Plus (TM) 5.3.1 11/14/08 13:03:59

awplus>
```

Related Commands banner exec
banner login (system)

boot system (file-path|URL)

This command specifies the release file that will load during the next boot cycle. The specified file must exist and be stored in the root directory of the flash file system.

Syntax `boot system <file-path/url>`

Parameter	Description
<code><file-path/url></code>	The file-path, or URL, of the release file.

Mode Global Configuration

Examples To boot a release file stored on the device flash file system, enter the following configuration commands, one per line and end with CNTL/Z.

```
awplus# configure terminal
awplus(config)# boot system flash:/r1-5.0.1.rel
```

In a VCStack configuration, if there is not enough space to synchronize the new release across the stack, the boot system command has an interactive mode that prompts you to delete old releases.

```
awplus# configure terminal
awplus(config)# boot system r1-5.0.2.rel
```

```
Insufficient flash available on stack member-2 (11370496)
to synchronize file r1-5.0.2.rel (14821895).

List of release files on stack member-2
  r1-5.0.1.rel (14822400)

Select files to free up space,
Delete awplus-2/flash:/r1-5.0.1.rel? (y/n) [n]:y
```

```
awplus(config)# y
```

```
Deleting selected files, please
wait.....
Successful operation
VCS synchronizing file across the stack, please
wait.....
File synchronization with stack member-2 successfully completed
[DONE]
```

clock set

This command sets the time and date for the system clock.

Syntax `clock set <hh:mm:ss> <day> <month> <year>`

Parameter	Description
<hh:mm:ss>	Local time in 24-hour format
<day>	Day of the current month <1-31>
<month>	The first three letters of the current month.
<year>	Current year <2000-2035>

Mode Privileged Exec

Usage Configure the timezone before setting the local time. Otherwise, when you change the timezone, the device applies the new offset to the local time.

Note  If Network Time Protocol (NTP) is enabled, then you cannot change the time or date using this command. NTP maintains the clock automatically using an external time source. If you wish to manually alter the time or date, you must first disable NTP.

Example To set the time and date on your system to 2pm on the 2nd of April 2007, use the command:

```
awplus# clock set 14:00:00 2 apr 2007
```

Related Commands [clock timezone](#)
[show clock](#)

clock summer-time date

This command defines the start and end of summertime for a specific year only, and specifies summertime's offset value to Standard Time for that year.

The **no** variant of this command removes the device's summertime setting. This clears both specific summertime dates and recurring dates (set with the [clock summer-time recurring command on page 8.10](#)).

By default, the device has no summer time definitions set.

Syntax `clock summer-time <timezone-name> date <start-day> <start-month>
<start-year> <start-time> <end-day> <end-month> <end-year>
<end-time> <1-180>`

`no clock summer-time`

Parameter	Description
<code><timezone-name></code>	A description of the summertime zone, up to 6 characters long.
<code>date</code>	Specifies that this is a date-based summertime setting for just the specified year.
<code><start-day></code>	Day that the summertime starts, in the range 1-31.
<code><start-month></code>	First three letters of the name of the month that the summertime starts.
<code><start-year></code>	Year that summertime starts, in the range 2000-2035.
<code><start-time></code>	Time of the day that summer time starts, in the 24-hour time format HH:MM.
<code><end-day></code>	Day that summertime ends, in the range 1-31.
<code><end-month></code>	First three letters of the name of the month that the summertime ends.
<code><end-year></code>	Year that summertime ends, in the range 2000-2035.
<code><end-time></code>	Time of the day that summer time ends, in the 24-hour time format HH:MM.
<code><1-180></code>	The offset in minutes.

Mode Global Configuration

Examples To set a summertime definition for New Zealand using NZST (UTC+12:00) as the standard time, and NZDT (UTC+13:00) as summertime, with the summertime set to begin on the 1st October 2007 and end on the 18th of March 2008:

```
awplus(config)# clock summer-time NZDT date 1 oct 2:00 2007 18
mar 2:00 2008 60
```

To remove any summer time settings on the system, use the command:

```
awplus(config)# no clock summer-time
```

Related Commands clock summer-time recurring
 clock timezone
 show clock

clock summer-time recurring

This command defines the start and end of summertime for every year, and specifies summertime's offset value to Standard Time.

The **no** variant of this command removes the device's summertime setting. This clears both specific summertime dates (set with the [clock summer-time date command on page 8.8](#)) and recurring dates.

By default, the device has no summertime definitions set.

Syntax `clock summer-time <timezone-name> recurring <start-week> <start-day>
<start-month> <start-time> <end-week> <end-day> <end-month>
<end-time> <1-180>`

`no clock summer-time`

Parameter	Description
<code><timezone-name></code>	A description of the summertime zone, up to 6 characters long.
<code>recurring</code>	Specifies that this summertime setting applies every year from now on.
<code><start-week></code>	Week of the month when summertime starts, in the range 1-5. The value 5 indicates the last week that has the specified day in it for the specified month. For example, to start summertime on the last Sunday of the month, enter 5 for <code><start-week></code> and sun for <code><start-day></code> .
<code><start-day></code>	Day of the week when summertime starts. Valid values are mon , tue , wed , thu , fri , sat or sun .
<code><start-month></code>	First three letters of the name of the month that summertime starts.
<code><start-time></code>	Time of the day that summertime starts, in the 24-hour time format HH:MM.
<code><end-week></code>	Week of the month when summertime ends, in the range 1-5. The value 5 indicates the last week that has the specified day in it for the specified month. For example, to end summertime on the last Sunday of the month, enter 5 for <code><end-week></code> and sun for <code><end-day></code> .
<code><end-day></code>	Day of the week when summertime ends. Valid values are mon , tue , wed , thu , fri , sat or sun .
<code><end-month></code>	First three letters of the name of the month that summertime ends.
<code><end-time></code>	Time of the day that summertime ends, in the 24-hour time format HH:MM.
<code><1-180></code>	The offset in minutes.

Mode Global Configuration

Examples To set a summertime definition for New Zealand using NZST (UTC+12:00) as the standard time, and NZDT (UTC+13:00) as summertime, with summertime set to start on the 1st Sunday in October, and end on the 3rd Sunday in March, use the command:

```
awplus(config)# clock summer-time NZDT recurring 1 sun oct 2:00
                 3 sun mar 2:00 60
```

To remove any summertime settings on the system, use the command:

```
awplus(config)# no clock summer-time
```

Related Commands [clock summer-time date](#)
[clock timezone](#)
[show clock](#)

clock timezone

This command defines the device's clock timezone. The timezone is set as a offset to the UTC.

The **no** variant of this command resets the system time to UTC.

By default, the system time is set to UTC.

Syntax `clock timezone <timezone-name> {minus|plus} <0-12>`
`no clock timezone`

Parameter	Description
<code><timezone-name></code>	A description of the timezone, up to 6 characters long.
<code>minus</code> or <code>plus</code>	The direction of offset from UTC. The minus option indicates that the timezone is behind UTC. The plus option indicates that the timezone is ahead of UTC.
<code><0-12></code>	The offset in hours from UTC.

Mode Global Configuration

Usage Configure the timezone before setting the local time. Otherwise, when you change the timezone, the device applies the new offset to the local time.

Examples To set the timezone to New Zealand Standard Time with an offset from UTC of +12 hours, use the command:

```
awplus(config)# clock timezone NZST plus 12
```

To set the timezone back to UTC with no offsets, use the command:

```
awplus(config)# no clock timezone
```

Related Commands `clock set`
`clock summer-time date`
`clock summer-time recurring`
`show clock`

debug nsm

This command specifies a set of debug options for use by Allied Telesis authorized service personnel only. Use this command to specify the debug options set for the routing manager.

Syntax `debug nsm [all|events|kernel|mcast|mcast6]`
`no debug nsm [all|events]`

Parameter	Description
<code>all</code>	Enables all the nsm debugging options.
<code>events</code>	Enables the nsm events debugging options.
<code>ha</code>	Enables the nsm high availability debugging options.
<code>kernel</code>	Enables the nsm kernel debugging options.
<code>mcast</code>	Enables the nsm IPv4 multicast debugging options.
<code>mcast6</code>	Enables the nsm IPv6 multicast debugging options.

Mode Privileged Exec and Global Configuration

Related Commands [show debugging nsm](#)
[undebug nsm](#)

debug nsm packet

This command specifies a set of debug options for use by Allied Telesis authorized service personnel only. Use this command to specify the debug options for the nsm packet.

Syntax `debug nsm packet [recv|send] [detail]`
`no debug nsm packet`

Mode Privileged Exec and Global Configuration

Related Commands [show debugging nsm](#)

diagnostic monitor pcsping

Use this command to disable or configure the background PCS (Physical Coding Sublayer) ping monitoring feature to either output a log message or to power off a XEM when a background PCS ping check fails.

The background PCS ping feature is enabled by default to output log messages.

Use the **no** variant of this command to re-enable the PCS ping monitoring feature, or restore default behavior to output a log message and not power off a XEM.

The background PCS ping feature is enabled by default to output log messages.

Syntax `diagnostic monitor pcsping {disable|power-off}`
`no diagnostic monitor pcsping {disable|power-off}`

Parameter	Description
<code>diagnostic monitor</code>	Enter these keywords to configure diagnostic monitoring.
<code>pcsping</code>	Enter this keyword to configure the PCS ping feature. A PCS ping is a small message that is sent across a switch link at the PHY layer. The PCS ping message contains data that identifies the source at one end of the link. If a PCS ping message is delivered then a XEM to switch link works.
<code>disable</code>	Select this required parameter to disable the background PCS (Physical Coding Sublayer) ping monitoring feature (not recommended). Negate a diagnostic monitor pcsping disable command to re-enable the background PCS ping feature.
<code>power-off</code>	Select this required parameter to power off a XEM if a background PCS (Physical Coding Sublayer) ping is not received on a XEM. Negate a diagnostic monitor pcsping power-off command to output a log message instead of powering off a XEM, restoring default behavior.

Default This feature is enabled by default to log a message when a background PCS ping check fails. Default behavior is restored by negating a **diagnostic monitor pcsping power-off** command.

Mode Global Configuration

Usage The background PCS ping feature implements background hardware monitoring to ensure the connections between the switch and the XEMs are working correctly, which is done by this feature periodically sending PCS pings to connected XEMs on a switch, by default.

A PCS ping is a small message that is sent across a switch link at the PHY layer. The PCS ping message contains data that identifies the source at one end of the link. If a PCS ping message is delivered then a XEM to switch link works.

To re-enable background PCS ping monitoring negate a **diagnostic monitor pcsping disable** command. A **no diagnostic monitor pcsping disable** command will re-enable the feature.

To log a message and not power off a XEM, negate a **diagnostic monitor pcsping power-off**

command. A **no diagnostic monitor pcsping power-off** command will not power off a XEM.

Note  We recommend that you do not disable the PCSping function, because this may conceal the existence of a faulty XEM module.

Examples To disable the background PCS ping monitoring feature, use the following commands:

```
awplus# configure terminal
awplus(config)# diagnostic monitor pcsping disable
```

Output Figure 8-1: Example output from a **show diagnostic monitor pcsping** command after issuing a **diagnostic monitor pcsping disable** command to disable the feature

```
awplus# configure terminal
awplus(config)# diagnostic monitor pcsping disable
awplus(config)# exit
awplus# show diagnostic monitor pcsping
Background PCS Ping Monitoring Information
Enabled: No
Power-off XEM if a PCS Ping fails: No
```

To re-enable the background PCS ping monitoring feature, use the following commands:

```
awplus# configure terminal
awplus(config)# no diagnostic monitor pcsping disable
```

Output Figure 8-2: Example output from a **show diagnostic monitor pcsping** command after issuing a **no diagnostic monitor pcsping disable** command to re-enable the feature

```
awplus# configure terminal
awplus(config)# no diagnostic monitor pcsping disable
awplus(config)# exit
awplus# show diagnostic monitor pcsping
Background PCS Ping Monitoring Information
Enabled: Yes
Power-off XEM if a PCS Ping fails: No
```

To power off a XEM when a background PCS ping check fails, use the following commands:

```
awplus# configure terminal
awplus(config)# diagnostic monitor pcsping power-off
```

Output Figure 8-3: Example output from a **show diagnostic monitor pcsping** command after issuing a **diagnostic monitor pcsping power-off** command to configure XEM power-off

```
awplus# configure terminal
awplus(config)# diagnostic monitor pcsping power-off
awplus(config)# exit
awplus# show diagnostic monitor pcsping
Background PCS Ping Monitoring Information
Enabled: Yes
Power-off XEM if a PCS Ping fails: Yes
```

To not power off a XEM, and only log a message, when a background PCS ping check fails, use the following commands:

```
awplus# configure terminal
awplus(config)# no diagnostic monitor pcsping power-off
```

Output Figure 8-4: Example output from a **show diagnostic monitor pcsping** command after issuing a **no diagnostic monitor pcsping power-off** command to restore log output

```
awplus# configure terminal
awplus(config)# no diagnostic monitor pcsping power-off
awplus(config)# exit
awplus# show diagnostic monitor pcsping
Background PCS Ping Monitoring Information
Enabled: Yes
Power-off XEM if a PCS Ping fails: No
```

Validation show diagnostic monitor pcsping
Commands show running-config

hostname

This command sets the name applied to the device as shown at the prompt. The hostname is:

- displayed in the output of the `show system` command
- displayed in the CLI prompt so you know which device you are configuring
- stored in the MIB object `sysName`

Use the **no** variant of this command to reset the hostname to the default value (`awplus`).

On a stack, after the stack master is elected, the master will have a host name: `awplus` by default, and this also becomes the name of the stack. Individual stack members (excluding the master) will have a host name that is the stack name hyphenated with a numeric suffix. For example, `awplus-1`, `awplus-2` and so on.

The hostname command can then be used to change the stack name and the stack master's host name. For example, for the hostname `Lab` the stack master's host name will be `Lab` and the other stack members will have host names `Lab-1`, `Lab-2` and so on.

In case of stack master fail-over, or stack split, the new stack will use the previous stack name as its host name and the stack name, unless it is changed by executing hostname command on the new stack master.

Use the **no** variant of this command to revert the hostname setting to its default value (`awplus`).

Syntax `hostname <hostname>`
`no hostname`

Parameter	Description
<code><hostname></code>	Specifies the network name of the system.

Default The default hostname is `awplus`.

Mode Global Configuration

Usage To specify or modify the host name, use the hostname global configuration command. The host name is used in prompts and default configuration filenames.

The name must also follow the rules for ARPANET host names. The name must start with a letter, end with a letter or digit, and use only letters, digits, and hyphens. Refer to RFC 1035.

Example To set the system name to `HQ-Sales`, use the command:

```
awplus# configure terminal
awplus(config)# hostname HQ-Sales
```

This changes the prompt to:

```
HQ-Sales(config)#
```

To revert to the default hostname `awplus`, use the command:

```
awplus# configure terminal
awplus(config)# no hostname
```

This changes the prompt to:

```
awplus(config)#
```

Related Commands [show system](#)

no debug all

This command disables the debugging facility for all features on your device. This stops the device from generating any diagnostic debugging messages.

The debugging facility is disabled by default.

Syntax `no debug all`

Mode Global Configuration and Privileged Exec

Example To disable debugging facility for all features, use the command:

```
awplus# no debug all
```

Related Commands [undebug all](#)

max-fib-routes

Use this command to set the maximum number of fib (forwarding information base) routes, excluding static routes. Note that static routes are set and reset using [max-static-routes](#).

Use the **no max-fib-routes** command to set the maximum number of fib routes to the default value of 4294967294 fib routes.

Syntax `max-fib-routes <1-4294967294>`

```
no max-fib-routes
```

Default The default number of fib routes is the maximum number of fib routes (4294967294).

Mode Global Configuration

Example To reset the maximum number of forwarding information base routes, use the command:

```
awplus# configure terminal
awplus(config)# no max-fib-routes
```

Related Commands [max-static-routes](#)

max-static-routes

Use this command to set the maximum number of static routes, excluding fib routes. Note that fib routes are set and reset using [max-fib-routes](#).

Use the **no max-static-routes** command to set the maximum number of static routes to the default value of 1000 static routes.

Syntax `max-static-routes <1-1000>`
`no max-static-routes`

Default The default number of static routes is the maximum number of static routes (1000).

Mode Global Configuration

Example To reset the maximum number of static routes to the default maximum, use the command:

```
awplus# configure terminal
awplus(config)# no max-static-routes
```

Related Commands [max-fib-routes](#)

show clock

This command displays the system's current configured local time and date. It also displays other clock related information such as timezone and summertime configuration.

For information on output options, see [“Controlling “show” Command Output”](#) on page 1.35.

Syntax `show clock`

Mode User Exec and Privileged Exec

Example To display the system's current local time, use the command:

```
awplus# show clock
```

Output Figure 8-5: Example output from the **show clock** command for a switch using New Zealand time

```
Local Time: Mon,  6 Aug 2007 13:56:06 +1200
UTC Time:  Mon,  6 Aug 2007 01:56:06 +0000
Timezone: NZST
Timezone Offset: +12:00
Summer time zone: NZDT
Summer time starts: Last Sunday in September at 02:00:00
Summer time ends: First Sunday in April at 02:00:00
Summer time offset: 60 mins
Summer time recurring: Yes
```

Table 8-1: Parameters in the output of the **show clock** command

Parameter	Description
Local Time	Current local time.
UTC Time	Current UTC time.
Timezone	The current configured timezone name.
Timezone Offset	Number of hours offset to UTC.
Summer time zone	The current configured summertime zone name.
Summer time starts	Date and time set as the start of summer time.
Summer time ends	Date and time set as the end of summer time.
Summer time offset	Number of minutes that summer time is offset from the system's timezone.
Summer time recurring	Whether the device will apply the summer time settings every year or only once.

Related Commands

- [clock set](#)
- [clock summer-time date](#)
- [clock summer-time recurring](#)
- [clock timezone](#)

show cpu

This command displays a list of running processes with their CPU utilization.

For information on output options, see [“Controlling “show” Command Output” on page 1.35.](#)

Syntax `show cpu [sort {thrds|pri|sleep|runtime}]`

Parameter	Description
sort	Whether to sort the list by a specified field. If you do not specify this, then the list is sorted by percentage CPU utilization.
thrds	The list is sorted by the number of threads.
pri	The list is sorted by the process priority.
sleep	The list is sorted by the average time sleeping.
runtime	The list is sorted by the runtime of the process.

Mode User Exec and Privileged Exec

Usage Entering this command on the stack master will display the information of all the stack members. A stack member heading will distinguish the different information for every stack member device.

Entering this command for a specific stack member (as a host-directed command) will display the information for that stack member.

Examples To show the cpu utilization of current processes, sorting them by the number of threads the processes are using, use the command:

```
awplus# show cpu sort thrds
```

Note that in a stack environment, executing this command on the stack master will show CPU utilization for all stack members.

To show CPU utilization for a specific stack member (in this case stack member 3), use the following command:

```
awplus# remote-command 3 show cpu
```

Output Figure 8-6: Example output from the `show cpu` command

```

Stack member 1:

CPU averages:
 1 second: 5%, 20 seconds: 0%, 60 seconds: 0%
System load averages:
 1 minute: 0.00, 5 minutes: 0.00, 15 minutes: 0.00
Current CPU load:
 userspace: 4%, kernel: 1%, interrupts: 0% iowaits: 0%

user processes
=====
 pid name          thrds  cpu%   pri  state  sleep%  runtime
1532 hostd          1     1.9   20   run    0       103
1113 exfx           18     0.9   20   sleep  0      3374
1225 aixexec       44     0.9   -2   sleep  0      2290
1630 mstpd          1     0.9   20   sleep  0       86
   1 init           1     0.0   20   sleep  0       799
6149 sh             1     0.0   20   sleep  0        0
6150 corerotate    1     0.0   20   sleep  0        0
  801 syslog-ng     1     0.0   20   sleep  0      287
  807 klogd         1     0.0   20   sleep  0        1
  858 inetd         1     0.0   20   sleep  0       21
  868 portmap      1     0.0   20   sleep  0        0
  879 crond         1     0.0   20   sleep  0        1
1038 openhpid      10     0.0   20   sleep  0      161
1057 hpilogd        1     0.0   20   sleep  0        0
1147 stackd         1     0.0   20   sleep  0       10
1170 hsl            1     0.0   20   sleep  0        1
1258 rpc.statd      1     0.0   20   sleep  0        0
1262 rpc.statd      1     0.0   20   sleep  0        0
1268 rpc.mountd    1     0.0   20   sleep  0        0
1361 automount      1     0.0   20   sleep  0       84
1395 ntpd           1     0.0   20   sleep  0       18
1440 authd          1     0.0   20   sleep  0       89
1463 bgpd           1     0.0   20   sleep  0       88
1483 cntrd          1     0.0   20   sleep  0       89
1509 epsrd         1     0.0   20   sleep  0       90
1560 imi            1     0.0   20   sleep  0       87
1581 irdpd          1     0.0   20   sleep  0       90
1603 lacpd         1     0.0   20   sleep  0       86
1653 nsm            1     0.0   20   sleep  0      111
1678 ospfd         1     0.0   20   sleep  0       89
1700 pdmd           1     0.0   20   sleep  0       88
1722 pimd           1     0.0   20   sleep  0       87
1743 ripd           1     0.0   20   sleep  0       90
1765 ripngd        1     0.0   20   sleep  0       88
1786 rmond          1     0.0   20   sleep  0       91
1798 sshd           1     0.0   20   sleep  0        0
1905 atlgetty       1     0.0   20   sleep  0        0
1906 getty          1     0.0   20   sleep  0        0

kernel threads
=====
 pid name          cpu%   pri  state  sleep%  runtime
  87 aio/0          0.0   15   sleep  0        0
   5 events/0       0.0   15   sleep  0      575
 673 fsl-cpm-spi.1  0.0   15   sleep  0        0
  58 kblockd/0      0.0   15   sleep  0        0
   6 khelper        0.0   15   sleep  0        1
 667 kmmcd          0.0   15   sleep  0        0
   3 ksoftirqd/0    0.0   15   sleep  0       78
  86 kswapd0        0.0   15   sleep  0        0
   2 kthreadd       0.0   15   sleep  0        0
 989 loop0          0.0    0   sleep  0       16
 648 mtddbldk       0.0   15   sleep  0        5
  84 pdflush        0.0   20   sleep  0        0
 732 rpciod/0       0.0   15   sleep  0        0
 689 wl_control     0.0   15   sleep  0        2
   4 watchdog/0    0.0  -100  sleep  0        0
 768 jffs2_gcd_mtd0 0.0   30   sleep  0        5
1264 lockd          0.0   20   sleep  0        0
1265 nfsd           0.0   20   sleep  0      130

```

Stack member 3:

CPU averages:

1 second: 12%, 20 seconds: 2%, 60 seconds: 2%

System load averages:

1 minute: 0.03, 5 minutes: 0.02, 15 minutes: 0.00

Current CPU load:

userspace: 6%, kernel: 4%, interrupts: 1% iowaits: 0%

user processes

=====

pid	name	thrds	cpu%	pri	state	sleep%	runtime
1544	hostd	1	2.8	20	run	0	120
1166	exfx	17	1.8	20	sleep	0	3846
1198	stackd	1	0.9	20	sleep	0	459
1284	aisexec	44	0.9	-2	sleep	0	2606
1	init	1	0.0	20	sleep	0	120
9772	sh	1	0.0	20	sleep	0	0
9773	corerotate	1	0.0	20	sleep	0	0
853	syslog-ng	1	0.0	20	sleep	0	356
859	klogd	1	0.0	20	sleep	0	1
910	inetd	1	0.0	20	sleep	0	3
920	portmap	1	0.0	20	sleep	0	0
931	crond	1	0.0	20	sleep	0	1
1090	openhpid	11	0.0	20	sleep	0	233
1111	hpilogd	1	0.0	20	sleep	0	0
1240	hsl	1	0.0	20	sleep	0	79
1453	authd	1	0.0	20	sleep	0	85
1477	bgpd	1	0.0	20	sleep	0	40
1497	cntrd	1	0.0	20	sleep	0	2
1520	epsrd	1	0.0	20	sleep	0	56
1571	imi	1	0.0	20	sleep	0	275
1594	irdpd	1	0.0	20	sleep	0	23
1617	lacpd	1	0.0	20	sleep	0	87
1638	mstpd	1	0.0	20	sleep	0	75
1662	nsm	1	0.0	20	sleep	0	163
1685	ospfd	1	0.0	20	sleep	0	35
1708	pdmd	1	0.0	20	sleep	0	23
1729	pimd	1	0.0	20	sleep	0	32
1751	ripd	1	0.0	20	sleep	0	33
1775	ripngd	1	0.0	20	sleep	0	25
1797	rmond	1	0.0	20	sleep	0	64
1963	ntpd	1	0.0	20	sleep	0	15
2102	atlgetty	1	0.0	20	sleep	0	0
2712	rpc.statd	1	0.0	20	sleep	0	0
2716	rpc.statd	1	0.0	20	sleep	0	0
2722	rpc.mountd	1	0.0	20	sleep	0	0
2821	automount	1	0.0	20	sleep	0	82
2892	ntpd	1	0.0	20	sleep	0	17
2912	sshd	1	0.0	20	sleep	0	0
9774	login	1	0.0	20	sleep	0	2
12689	more	1	0.0	20	sleep	0	0

kernel threads

=====

pid	name	cpu%	pri	state	sleep%	runtime
3	ksoftirqd/0	1.9	15	sleep	0	2605
87	aio/0	0.0	15	sleep	0	0
5	events/0	0.0	15	sleep	0	588
673	fsl-cpm-spi.1	0.0	15	sleep	0	0
58	kblockd/0	0.0	15	sleep	0	0
6	khelper	0.0	15	sleep	0	1
667	kmmcd	0.0	15	sleep	0	0
86	kswapd0	0.0	15	sleep	0	0
2	kthreadd	0.0	15	sleep	0	0
1041	loop0	0.0	0	sleep	0	18
648	mtdblockd	0.0	15	sleep	0	5
84	pdflush	0.0	20	sleep	0	0
784	rpciod/0	0.0	15	sleep	0	0
689	wl_control	0.0	15	sleep	0	3
4	watchdog/0	0.0	-100	sleep	0	0
820	jffs2_gcd_mtd0	0.0	30	sleep	0	1
2718	lockd	0.0	20	sleep	0	0
2719	nfsd	0.0	20	sleep	0	0

Table 8-2: Parameters in the output of the **show cpu** command

Parameter	Description
Stack member	The ID of the stack member. Displayed if the switch is in a stack.
System load averages	The average number of processes waiting for CPU time for the periods stated.
Current CPU load	Current CPU utilization specified by load types.
CPU averages	Average CPU utilization for the periods stated.
pid	Identifier number of the process.
name	A shortened name for the process
thrds	Number of threads in the process.
cpu%	Percentage of CPU utilization that this process is consuming.
pri	Process priority state.
state	Process state; one of "run", "sleep", "zombie", and "dead".
sleep%	Percentage of time that the process is in the sleep state.
runtime	The time that the process has been running for, measured in jiffies. A jiffy is the duration of one tick of the system timer interrupt.

Related Commands

- [remote-command](#)
- [show memory](#)
- [show memory allocations](#)
- [show memory history](#)
- [show memory pools](#)
- [show process](#)

show cpu history

This command prints a graph showing the historical CPU utilization.

For information on output options, see [“Controlling “show” Command Output” on page 1.35](#).

Syntax `show cpu history`

Mode User Exec and Privileged Exec

Usage This command's output displays three graphs of the percentage CPU utilization:

- per second for the last minute, then
- per minute for the last hour, then
- per 30 minutes for the last 30 hours.

If this command is entered on the stack master, it will print graphs for all the stack members. A stack member heading will be displayed to distinguish the different graphs for every stack member.

If the command is entered on a specific stack member, as a host-directed command, it will print the graph for that particular stack member.

Examples To display a graph showing the historical CPU utilization of the device, use the command:

```
awplus# show cpu history
```

To display the CPU utilization history graph for another stack member, use the command:

```
awplus# remote-command 3 show cpu history
```

where 3 is the node id of the stack member.

show debugging

This command displays information for all debugging options.

For information on output options, see [“Controlling “show” Command Output”](#) on page 1.35.

Syntax show debugging

Default This command runs all the show debugging commands in alphabetical order.

Mode User Exec and Privileged Exec

Usage This command displays all debugging information, similar to the way the [show tech-support](#) command displays all show output for use by Allied Telesis authorized service personnel only.

Example To display all debugging information, use the command:

```
awplus# show debugging
```

Output Figure 8-8: Example output from the [show debugging](#) command

```
awplus#show debugging
x900#show debugging
AAA debugging status:
  Authentication debugging is off
  Accounting debugging is off
BGP debugging status:
  BGP debugging is off
  BGP nsm debugging is off
  BGP events debugging is off
  BGP keepalives debugging is off
  BGP updates debugging is off
  BGP fsm debugging is off
  BGP filter debugging is off
  BGP Route Flap Dampening debugging is off

802.1X debugging status:

EPSR debugging status:
  EPSR Info debugging is off
  EPSR Message debugging is off
  EPSR Packet debugging is off
  EPSR State debugging is off
IGMP Debugging status:
  IGMP Decoder debugging is off
  IGMP Encoder debugging is off
```

Related Commands

- [show debugging aaa](#)
- [show debugging bgp](#)
- [show debugging dot1x](#)
- [show debugging epsr](#)
- [show debugging igmp](#)
- [show debugging ip packet](#)
- [show debugging lacp](#)
- [show debugging lldp](#)
- [show debugging mstp](#)
- [show debugging nsm](#)
- [show debugging ospf](#)

```
show debugging pim dense-mode
show debugging pim sparse-mode
show debugging radius
show debugging rip
show debugging snmp
show debugging stack
show debugging vrrp
```

show debugging nsm

This command displays system details for use by Allied Telesis authorized service personnel only.

For information on output options, see [“Controlling “show” Command Output”](#) on page 1.35.

Syntax `show debugging nsm`

Mode User Exec and Privileged Exec

Related Commands `debug nsm`

show diagnostic monitor pcsping

Use this command to show the status of the background PCS (Physical Coding Sublayer) ping feature used to check the link status between a XEM and the switch. See the [diagnostic monitor pcsping command on page 8.14](#) for further information about the feature.

Syntax show diagnostic monitor pcsping

Mode Privileged Exec

Example To monitor the status of the background PCS ping feature, use the following command:

```
awplus# show diagnostic monitor pcsping
```

Output Figure 8-9: Example output from a **show diagnostic monitor pcsping** command showing default behaviour (enabled with log message output) for the background PCS ping feature

```
awplus# show diagnostic monitor pcsping
Background PCS Ping Monitoring Information
Enabled: Yes
Power-off XEM if a PCS Ping fails: No
```

Figure 8-10: Example output from a **show diagnostic monitor pcsping** command showing the background PCS ping feature disabled

```
awplus# show diagnostic monitor pcsping
Background PCS Ping Monitoring Information
Enabled: No
Power-off XEM if a PCS Ping fails: No
```

Figure 8-11: Example output from a **show diagnostic monitor pcsping** command showing the background PCS ping feature configured to power off a XEM if PCS ping fails

```
awplus# show diagnostic monitor pcsping
Background PCS Ping Monitoring Information
Enabled: Yes
Power-off XEM if a PCS Ping fails: Yes
```

Validation Commands show running-config

Related Commands diagnostic monitor pcsping

show memory

This command displays the memory used by each process that is currently running

For information on output options, see [“Controlling “show” Command Output” on page 1.35.](#)

Syntax `show memory [sort {size|peak|stk}]`

Parameter	Description
<code>sort</code>	Changes the sorting order for the list of processes. If you do not specify this, then the list is sorted by percentage memory utilization.
<code>size</code>	Sorts the list by the amount of memory the process is currently using.
<code>peak</code>	Sorts the list by the peak amount of memory the process has ever used.
<code>stk</code>	Sorts the list by the stack size of the process.

Mode User Exec and Privileged Exec

Usage If this command is entered on the stack master, it will display corresponding memory utilization information for all the stack members. A stack member heading will be displayed to distinguish the different lists for every stack member.

If it is entered on a specific stack member, as host-directed commands, it will display corresponding memory utilization information for that stack member.

Example To display the memory used by the current running processes, use the command:

```
awplus# show memory
```

Output Figure 8-12: Example output from the `show memory` command

```
RAM total: 514920 kB; free: 382716; buffers: 16368 kB

user processes
=====
pid name          mem%   size   peak   data   stk
962 pss           6    33112  36260  27696  244
1  init            0     348   1092   288    84
797 syslog-ng      0     816   2152   752    84
803 klogd          0     184   1244   124    84
843 inetd          0     256   1256   136    84
```

Table 8-3: Parameters in the output of the `show memory` command

Parameter	Description
<code>RAM total</code>	Total amount of RAM memory free.
<code>free</code>	Available memory size.
<code>buffers</code>	Memory allocated kernel buffers.
<code>pid</code>	Identifier number for the process.
<code>name</code>	Short name used to describe the process.

Table 8-3: Parameters in the output of the **show memory** command (cont.)

Parameter	Description
mem%	Percentage of memory utilization the process is currently using.
size	Amount of memory currently used by the process.
peak	Greatest amount of memory ever used by the process.
data	Amount of memory used for data.
stk	The stack size.

Related Commands [show memory allocations](#)
[show memory history](#)
[show memory pools](#)

show memory allocations

This command displays the memory allocations used by processes.

For information on output options, see [“Controlling “show” Command Output” on page 1.35.](#)

Syntax `show memory allocations [<process>]`

Parameter	Description
<process>	Displays the memory allocation used by the specified process.

Mode User Exec and Privileged Exec

Usage If entered on the stack master, this command will display corresponding memory utilization information for all the stack members. A stack member heading will be displayed to distinguish the different lists for every stack member.

If it is entered on a specific stack member, as host-directed commands, it will display corresponding memory utilization information for that stack member.

Examples To display the memory allocations used by all processes on your device, use the command:

```
awplus# show memory allocations
```

To display the memory allocations used by BGP, use the command:

```
awplus# show memory allocations bgp
```

Output Figure 8-13: Example output from the `show memory allocations` command

```
Memory allocations for BGP
-----
name bgpd; pid 1155; size 2860; peak 8988; data 2360; stack 84
LDP Id
filename:line    allocated      freed
+               lib.c:614      296
=====
296
Memory diagnostics
filename:line    allocated      freed
+               gmem_diag.c:149  1820
+               gmem_diag.c:199  3024
=====
4860
```

Table 8-4: Parameters in the output from the **show memory allocations** command

Parameter	Description
name	Short name used to describe the process.
pid	Identifier number for the process.
size	Amount of memory in kB used by the process.
peak	The peak amount of memory in kB ever used by the process.
data	Amount of memory used for data.
stack	The stack size.

Related Commands [show memory](#)
[show memory history](#)
[show memory pools](#)
[show tech-support](#)

show memory history

This command prints a graph showing the historical memory usage.

For information on output options, see [“Controlling “show” Command Output”](#) on page 1.35.

Syntax `show memory history`

Mode User Exec and Privileged Exec

Usage This command's output displays three graphs of the percentage memory utilization:

- per second for the last minute, then
- per minute for the last hour, then
- per 30 minutes for the last 30 hours.

If entered on the stack master, this command will display corresponding memory utilization information for all the stack members. A stack member heading will be displayed to distinguish the different lists for every stack member.

If it is entered on a specific stack member, as host-directed commands, it will display corresponding memory utilization information for that stack member.

Examples To show a graph displaying the historical memory usage for either a single unstacked device, or a complete stack, use the command:

```
awplus# show memory history
```

To show a graph displaying the historical memory usage for a single device (device 3 in this example) within a stack, use the command:

```
awplus# remote-command 3 show memory history
```

Output Figure 8-14: Example output from the **show memory history** command

```

STACK member 1:

Per minute memory utilization history

100
 90
 80
 70
 60
 50
 40 *****
 30
 20
 10
   |...|...|...|...|...|...|...|...|...|...|...|...
   Oldest                                         Newest
      Memory utilization% per minute (last 60 minutes)
          * = average memory utilisation%.
.
.
-----

STACK member 2:

Per minute memory utilization history

100
 90
 80
 70
 60
 50
 40 *****
 30
 20
 10
   |...|...|...|...|...|...|...|...|...|...|...|...
   Oldest                                         Newest
      Memory utilization% per minute (last 60 minutes)
          * = average memory utilisation%.
.
.

```

Related Commands [show memory allocations](#)
[show memory pools](#)
[show tech-support](#)

show memory pools

This command shows the memory pools used by processes.

For information on output options, see “Controlling “show” Command Output” on page 1.35.

Syntax `show memory pools [<process>]`

Parameter	Description
<process>	Displays the memory pools used by the specified process.

Mode User Exec and Privileged Exec

Example To show the memory pools used by processes, use the command:

```
awplus# show memory pools
```

Output Figure 8-15: Example output from the `show memory pools` command

```

Memory pools for BGP
-----
name bgpd; pid 1207; size 1996; peak 8640; data 2012; stack 84
pool allocated
----
LDP Id                296
Memory diagnostics   2508
Message of The Day    96
Host config           8
Link list             320
Rmap                  64
Temporary memory     113440
Vector                21992
.
.
.
Application Total (kb)      283

```

Table 8-5: Parameters in the output from the `show memory pools` command

Parameter	Description
name	Short name used to describe the process.
pid	Identifier for the process.
size	Amount of memory in kB used by the process.
peak	Peak amount of memory in kB ever used by the process.
data	Amount of memory in kB used for data.
stack	The stack size in kB.

Related Commands

- `show memory allocations`
- `show memory history`
- `show tech-support`

show nsm client

This command displays system details for use by Allied Telesis authorized service personnel only.

For information on output options, see [“Controlling “show” Command Output” on page 1.35.](#)

Syntax `show nsm client`

Mode Privileged Exec

show process

This command lists a summary of the current running processes.

For information on output options, see [“Controlling “show” Command Output” on page 1.35.](#)

Syntax `show process [sort {cpu|mem}]`

Parameter	Description
sort	Changes the sorting order for the list of processes.
cpu	Sorts the list by the percentage of CPU utilization.
mem	Sorts the list by the percentage of memory utilization.

Mode User Exec and Privileged Exec

Usage For a stacked configuration, if this command is entered on the stack master, it will display the information for all the stack members. A stack member heading will be displayed to distinguish the different information for every stack member.

If it is entered on a specific stack member, as a host-directed command, it will display the information for that stack member.

Example To display a summary of the current running processes, use the command:

```
awplus# show process
```

Output Figure 8-16: Example output from the **show process** command

```

CPU load for 1 minute: 0%; 5 minutes: 3%; 15 minutes: 0%
RAM total: 514920 kB; free: 382600 kB; buffers: 16368 kB

user processes
=====
pid name          thrds  cpu%  mem%  pri  state  sleep%
962 pss            12    0     6    25  sleep   5
1  init            1     0     0    25  sleep   0
797 syslog-ng       1     0     0    16  sleep  88

kernel threads
=====
pid name          cpu%  pri  state  sleep%
71  aio/0           0    20  sleep  0
3   events/0        0    10  sleep  98

```

Table 8-6: Parameters in the output from the **show process command**

Parameter	Description
CPU load	Average CPU load for the given period.
RAM total	Total memory size.
free	Available memory.
buffers	Memory allocated to kernel buffers.
pid	Identifier for the process.
name	Short name to describe the process.
thrds	Number of threads in the process.
cpu%	Percentage of CPU utilization that this process is consuming.
mem%	Percentage of memory utilization that this process is consuming..
pri	Process priority.
state	Process state; one of "run", "sleep", "stop", "zombie", or "dead".
sleep%	Percentage of time the process is in the sleep state.

Related Commands

- remote-command
- show cpu
- show cpu history

show router-id

Use this command to show the Router ID of the current system.

For information on output options, see [“Controlling “show” Command Output” on page 1.35](#).

Syntax `show router-id`

Mode User Exec and Privileged Exec

Example To display the Router ID of the current system, use the command:

```
awplus# show router-id
```

Output Figure 8-17: Example output from the **show router-id** command

```
awplus>show router-id
Router ID: 10.55.0.2 (automatic)
```

show system

This command displays general system information about the device, including the hardware installed, memory, and software versions loaded. It also displays location and contact details when these have been set.

For information on output options, see [“Controlling “show” Command Output” on page 1.35.](#)

Syntax `show system`

Mode User Exec and Privileged Exec

Usage For a stacked configuration, if this command is entered on the stack master, it will display the information for all the stack members. A stack member heading will be displayed to distinguish the different information for every stack member.

If it is entered on a specific stack member, as a host-directed command, it will display the information for that stack member.

Examples To display the system information for a single switch, or a whole stack, use the command:

```
awplus# show system
```

To display the system information of stack member 3, use the command:

```
awplus# remote-command 3 show system
```

Output [Figure 8-18: Example output from the show system command](#)

```
Switch System Status                               Wed Dec 19 08:42:16 2007
Board      ID  Bay  Board Name                      Rev  Serial number
-----
Base       219          AT-9924T-EMC                    A-0  61556953
-----
Memory:   DRAM: 255196 kB  Flash: 30.0MB Used: 26.4MB Available: 3.6MB
-----
Environment Status : Normal
Uptime           : 25 days 11:41:58
Bootloader version : 1.0.9

Current software   : r2-main-20071011-1.rel
Software version  : main 20071011-1
Build date        : Thu Oct 11 02:41:04 NZDT 2007

Current boot config: flash:/default.cfg (file exists)
Territory         : usa

System Name

System Contact

System Location
```

Figure 8-19: Example output from the `show system` command for a stacked configuration

```

Stack System Status                                     Tue Aug  7 05:25:09 2007

Stack member 1:

Board          ID  Bay  Board Name          Rev  Serial number
-----
Base           270         x900-24XT           B-0  41FY68006
Expansion      272  Bay1  XEM-1XP             B-0  41AR65001
Expansion      285  Bay2  XEM-STK             A-0  M1L174004
PSU            212  PSU1  AT-PWR01-AC        F-1  66354904
Fan module     214  PSU2  AT-FAN01            F-1  66098695
-----
Memory:  DRAM: 514460 kB  Flash: 31.0MB Used: 25.1MB Available: 5.9MB
-----
Environment Status: Normal
Uptime: 0 days 04:26:02

Stack member 2:

Board          ID  Bay  Board Name          Rev  Serial number
-----
Base           271         x900-24XS           A-2  41HF6900U
Expansion      272  Bay1  XEM-1XP             A-0  41AR5B003
Expansion      285  Bay2  XEM-STK             (nul M1L17400T
PSU            212  PSU1  AT-PWR01-AC        F-1  66354904
Fan module     214  PSU2  AT-FAN01            F-1  66098695
-----
Memory:  DRAM: 514460 kB  Flash: 31.0MB Used: 25.2MB Available: 5.8MB
-----
Environment Status: Normal
Uptime: 0 days 00:01:14

Bootloader version : 1.0.9
Current software   : r1-5.2.2-20080807-2.rel
Software version   : 5.2.2 20070807-2
Build date        : Tue Aug 7 09:27:05 NZST 2008

Current boot config: flash:/default.cfg (file exists)
Territory         : usa

System Name

System Contact

System Location
    
```

Related Commands `remote-command`
 `show system environment`

show system environment

This command displays the current environmental status of your device and any attached PSU, XEM, or other expansion option. The environmental status covers information about temperatures, fans, and voltage.

For information on output options, see [“Controlling “show” Command Output” on page 1.35.](#)

Syntax show system environment

Mode User Exec and Privileged Exec

Usage For a stacked configuration, if this command is entered on the stack master, it will display the information for all the stack members. A stack member heading will be displayed to distinguish the different information for every stack member.

If it is entered on a specific stack member, as a host-directed command, it will display the information for that stack member.

Example To display the system's environmental status, use the command:

```
awplus# show system environment
```

Output Figure 8-20: Example output from the `show system environment` command

```
Environment Monitoring Status
Overall Status: ***Fault***

Resource ID: 1 Name: PSU bay 1
ID Sensor (Units)      Reading  Low Limit High Limit Status
1 Device Present      0        -        -        -        FAULT
2 PSU Overtemp        0        -        -        -        Ok
3 PSU Fan Fail        0        -        -        -        Ok
4 PSU Power Good      0        -        -        -        Ok

Resource ID: 2 Name: PSU bay 2
ID Sensor (Units)      Reading  Low Limit High Limit Status
1 Device Present      1        -        -        -        Ok
2 PSU Overtemp        0        -        -        -        Ok
3 PSU Fan Fail        0        -        -        -        Ok
4 PSU Power Good      1        -        -        -        Ok

Resource ID: 3 Name: x900-24XS
ID Sensor (Units)      Reading  Low Limit High Limit Status
1 Voltage: 2.5V (Volts) 2.578    0.000    3.320    Ok
2 Voltage: 1.65V (Volts) 1.629    0.000    2.988    Ok
3 Voltage: 3.3V (Volts) 3.369    0.000    4.383    Ok
4 Voltage: 1.8V (Volts) 1.771    0.000    6.641    Ok
5 Voltage: 1.2V (Volts) 12.000   0.000    15.938   Ok
6 Temp: Ambient (Degrees C) 30       -127     100      Ok
7 Temp: Sensor chip (Degrees C) 46       -127     85       Ok
8 Temp: Internal (Degrees C) 43       -127     127      Ok

Resource ID: 4 Name: XEM-12S
ID Sensor (Units)      Reading  Low Limit High Limit Status
1 Fan: XEM Fan 1 (Rpm) 5153    3516     -        Ok
2 Voltage: 2.5V (Volts) 2.539    2.344    2.865    Ok
3 Voltage: 1.65V (Volts) 1.603    1.491    1.814    Ok
4 Voltage: 3.3V (Volts) 3.334    2.973    3.627    Ok
5 Voltage: 5V (Volts) 4.948    4.505    5.495    Ok
6 Voltage: 12V (Volts) 11.563   10.813   13.188   Ok
7 Voltage: 1.8V (Volts) 1.828    1.617    1.983    Ok
8 Temp: Internal (Degrees C) 42       70 (Hyst) 85       Ok
```

Related Commands [show system](#)

show system interrupts

Use this command to display the number of interrupts for each IRQ (Interrupt Request) used to interrupt input lines on a PIC (Programmable Interrupt Controller) on your switch.

For information on output options, see [“Controlling “show” Command Output” on page 1.35.](#)

Syntax `show system interrupts`

Mode User Exec and Privileged Exec

Example To display information about the number of interrupts for each IRQ in your device, use the command:

```
awplus# show system interrupts
```

Output [Figure 8-21: Example output from the `show system interrupts` command](#)

```
awplus>show system interrupts
      CPU0
  1:      2   CPM2 SIU  Level Enabled  0   i2c-mpc
  2:     145  CPM2 SIU  Level Enabled  0   spi-mpc
 77:      0   OpenPIC  Level Enabled  0   enet_tx
 78:      2   OpenPIC  Level Enabled  0   enet_rx
 82:      0   OpenPIC  Level Enabled  0   enet_error
 90:     5849  OpenPIC  Level Enabled  0   serial
 91:    2066672 OpenPIC  Level Enabled  0   i2c-mpc
 94:      147  OpenPIC  Level Enabled  0   cpm2_cascade
112:      5   OpenPIC  Edge Enabled  0   phy_interrupt
114:    398714  OpenPIC  Level Enabled  0   mvPP
115:    26247  OpenPIC  Level Enabled  0   mvPP
119:      0   OpenPIC  Edge Enabled  0   Power supply status
120:      0   OpenPIC  Edge Enabled  0   Plugin XEM
BAD:      0
```

Related Commands [show system environment](#)

show system pci device

Use this command to display the PCI devices on your switch.

For information on output options, see [“Controlling “show” Command Output” on page 1.35.](#)

Syntax `show system pci device`

Mode User Exec and Privileged Exec

Example To display information about the PCI devices on your switch, use the command:

```
awplus# show system pci device
```

Output Figure 8-22: Example output from the `show system pci device` command

```
awplus>show system pci device
00:0c.0 Class 0200: 11ab:00d1 (rev 01)
  Flags: bus master, 66Mhz, medium devsel, latency 128, IRQ 113
  Memory at 5ffff000 (32-bit, non-prefetchable) [size=4K]
  Memory at 58000000 (32-bit, non-prefetchable) [size=64M]

00:0d.0 Class 0200: 11ab:00d1 (rev 01)
  Flags: bus master, 66Mhz, medium devsel, latency 128, IRQ 116
  Memory at 57fff000 (32-bit, non-prefetchable) [size=4K]
  Memory at 50000000 (32-bit, non-prefetchable) [size=64M]
```

Related Commands [show system environment](#)
[show system pci tree](#)

show system pci tree

Use this command to display the PCI tree on your switch.

For information on output options, see [“Controlling “show” Command Output” on page 1.35.](#)

Syntax `show system pci tree`

Mode User Exec and Privileged Exec

Example To display information about the PCI tree on your switch, use the command:

```
awplus# show system pci tree
```

Output Figure 8-23: Example output from the `show system pci tree` command

```
awplus>show system pci tree
-[00]--+0c.0 11ab:00d1
  \-0d.0 11ab:00d1
```

Related Commands [show system environment](#)
[show system pci device](#)

show system pluggable

This command displays information about the pluggable transceivers, such as SFPs and XFPs, which are currently installed in your switch.

For information on output options, see [“Controlling “show” Command Output” on page 1.35.](#)

Syntax `show system pluggable`

Mode User Exec and Privileged Exec

Usage For a stacked configuration, if this command is entered on the stack master, it will display information about the pluggable transceiver for all the stack members. A stack member heading will be displayed to distinguish the different pluggable transceiver information for every stack member.

If it is entered on a specific stack member, as a host-directed command, it will display information about the pluggable transceiver for that stack member.

Example To display information about the pluggable transceiver installed in your switch, use the command:

```
awplus# show system pluggable
```

Output Figure 8-24: Example output from the `show system pluggable` command

System Pluggable Information					
Port	Manufacturer	Device	Serial Number	Datecode	Type
0.5	AGILENT	HBCU-5710R	AK051400PV	050408	1000BASE-T
0.9	FINISAR CORP.	FCMJ-8521-3	P6606MY	040803	1000BASE-T
0.14	AGILENT	HFBR-5710L	0401312315461272	040131	1000BASE-SX
0.17	AGILENT	QBCU-5730R	AK0614GKF7	060408	1000BASE-T
0.20	AGILENT	HFBR-5710L	0305130112182696	030513	1000BASE-SX
0.23	AGILENT	HBCU-5710R	AK051300SM	050402	1000BASE-T
2.1	AGILENT	HFCT-721XPD	MB01300D	05121201	10GBASE-LR

Related Commands [show system environment](#)
[show system pluggable detail](#)

show system pluggable detail

This command displays detailed information about the pluggable transceivers, such as SFPs or XFPs, which are currently installed in your switch.

In addition to the information about pluggable transceivers displayed using the [show system pluggable](#) command (port, manufacturer, serial number, manufacturing datecode, and type information), the **show system pluggable detail** command displays the following information:

- **Wavelength:** Specifies the laser wavelength of the installed pluggable transceiver
- **Single mode length:** Specifies the link length supported by the pluggable transceiver using single mode fiber
- **OM1 length:** Specifies the link length supported by the pluggable transceiver using 62.5 micron multi-mode fiber.
- **OM2 length:** Specifies the link length supported by the pluggable transceiver using 50 micron multi-mode fiber.

Note For parameters that are not supported or not specified, a hyphen is displayed instead.



For information on output options, see ["Controlling "show" Command Output" on page 1.35.](#)

Syntax `show system pluggable detail`

Mode User Exec and Privileged Exec

Usage For a stacked configuration, if this command is entered on the stack master, it will display detailed information about the pluggable transceivers for all the stack members. A stack member heading will be displayed to distinguish the different pluggable transceiver information for every stack member.

If it is entered on a specific stack member, as a host-directed command, it will display detailed information about the pluggable transceiver for that stack member.

Example To display detailed information about the pluggable transceivers installed on a standalone switch, use the command:

```
awplus# show system pluggable detail
```

Output Figure 8-25: Example output from the `show system pluggable detail` command on a switch

```

System Pluggable Information Detail

Port1.0.45
=====
Vendor Name:           ATI
Device Name:           AT-SPLX10
Device Type:           1000BASE-LX
Serial Number:         0000071004100004
Manufacturing Datecode: 07040900
SFP Laser Wavelength: 1310nm
Link Length Supported
  Single Mode Fiber :   10000m
  OM1 (62.5um) Fiber:  -
  OM2 (50um) Fiber  :   -

```

Example To display detailed information about the pluggable transceivers installed on a stack, use the command:

```
awplus# show system pluggable detail
```

Output Figure 8-26: Example output from the `show system pluggable detail` command on a stack

```

Stack member 1:

Port1.0.45
=====
Vendor Name:           AGILENT
Device Name:           HFCT-5710L
Device Type:           1000BASE-LX
Serial Number:         0402142241184360
Manufacturing Datecode: 040214
SFP Laser Wavelength: -
Link Length Supported
  Single Mode Fiber :   10Km
  OM1 (62.5um) Fiber:  550m
  OM2 (50um) Fiber  :   550m

Stack member 2:

Port2.0.47
=====
Vendor Name:           FINISAR CORP.
Device Name:           FTRJ-8519-7D-CSC
Device Type:           1000BASE-SX
Serial Number:         P430KGY
Manufacturing Datecode: 030718
SFP Laser Wavelength:  850nm
Link Length Supported
  Single Mode Fiber :   -
  OM1 (62.5um) Fiber:  300m
  OM2 (50um) Fiber  :   550m

```

Related Commands `show system environment`
`show system pluggable`

show system psu

This command shows the PSU (Power Supply Unit) status information for the x908 series PSUs only. This command returns a console error message when run on other x900 switches.

For information on output options, see [“Controlling “show” Command Output” on page 1.35.](#)

Syntax `show system psu`

Mode Privileged Exec

Usage Running this command on switches other than an x908 results in an error message as shown:

```
awplus#show system psu
% This command is not applicable to this device.
```

Example To display the PSU status information, use the command:

```
awplus# show system psu
```

Output Figure 8-27: Example output from the `show system psu` command on an x908 switch

```
awplus#show system psu
System PSU Status

Resource ID: 4  Name: AT-PWR05-AC  Bay: 1
Part Number    : FNP600-12G
Serial Number   : 070252-001DB
Revision       : AD
Mfg. date      : 2007-02-05
Manufacturer    : POWER-ONE
Mfg. location  : 02

Device Ratings:
Output rail 1  : 12000 mV, 51000 mA
Output rail 2  : 12000 mV, 500 mA
Output Power   : 600 W
Min AC input   : 85 V
Max AC input   : 264 V

Dynamic Data:
Fault Bytes    : 00 00 00 00
Fan Speed      : 13300 RPM
Time in service : 41 hours
Measured rail 1 : 12224 mV, 7304 mA
Measured rail 2 : 0 mV, 0 mA

Resource ID: 5  Name: AT-PWR05-AC  Bay: 2
Part Number    : FNP600-12G
Serial Number   : 070252-001D1
Revision       : AD
Mfg. date      : 2007-02-05
Manufacturer    : POWER-ONE
Mfg. location  : 02

Device Ratings:
Output rail 1  : 12000 mV, 51000 mA
Output rail 2  : 12000 mV, 500 mA
Output Power   : 600 W
Min AC input   : 85 V
Max AC input   : 264 V

Dynamic Data:
Dynamic data invalid. PSU may be powered off.
awplus#
```

show system serialnumber

This command shows the serial number information for the switch.

For information on output options, see [“Controlling “show” Command Output”](#) on page 1.35.

Syntax `show system serialnumber`

Mode Privileged Exec

Example To display the serial number information for the switch, use the command:

```
awplus# show system serialnumber
```

Output Figure 8-28: Example output from the `show system serialnumber` command

```
awplus#show system serialnumber
45AX5300X
awplus#
```

show tech-support

The **show tech-support** command generates system and debugging information for the switch and saves it to a file. You can optionally limit it to display only information for a given protocol.

The command generates a large amount of output and the output is saved into a file. The output file name can be specified by the **outfile** option. If the output file already exists, a new file name is generated with the current time stamp. Since output files may be too large for flash on the switch we recommend saving files to an SD card whenever possible to avoid switch lockup.

If **all** is specified the command captures the full list of information of the device. If **bgp** is specified the command captures information specific to BGP, and so on. If **system** is specified the command captures general system information of the device.

For information on output options, see [“Controlling “show” Command Output” on page 1.35.](#)

Syntax `show tech-support [all] [outfile <filename>]`

```
show tech-support {[bgp] [dhcpsn] [epsr] [igmp] [ip] [ipv6] [ospf]
  [pim] [rip] [ripng] [mld] [stack] [stp] [system]}
  [outfile <filename>]
```

Parameter	Description
all	output full troubleshooting information for all protocols and the device
bgp	output only BGP protocol specific troubleshooting information
dhcpsn	output only DHCP snooping specific troubleshooting information
epsr	output only EPSR protocol specific troubleshooting information
igmp	output only IGMP protocol specific troubleshooting information
ip	output only IP protocol specific troubleshooting information
ipv6	output only IPv6 protocol specific troubleshooting information
ospf	output only OSPF protocol specific troubleshooting information
pim	output only PIM protocol specific troubleshooting information
rip	output only RIP protocol specific troubleshooting information
ripng	output only RIPng protocol specific troubleshooting information
mld	output only MLD protocol specific troubleshooting information
stack	output only stacking device specific troubleshooting information
stp	output only STP protocol specific troubleshooting information
system	output general system (not protocol) troubleshooting information
outfile	keyword used to specify the file name for the output file
<filename>	placeholder used to specify the file name for the output file

Default The **show tech-support** command by default captures **all** information for the switch.

By default the output is saved to the file 'tech-support.txt.gz' in the current directory. If this file already exists in the current directory then a new file is generated with the time stamp appended to the file name, for example 'tech-support20080109.txt.gz', so the last saved file is retained.

Mode Privileged Exec

Usage The **show tech-support** command is useful for collecting a large amount of information about all protocols or specific protocols on your switch for troubleshooting purposes. The output of this command can be provided to technical support representatives when reporting a problem.

Examples To capture the full set of show output for the technical support, use the command:

```
awplus# show tech-support
```

To capture show output related to IP module and save it to a file named support-ip.txt.gz on the SD card, use the below command:

```
awplus# show tech-support ip outfile card:support-ip.txt.gz
```

To capture the system technical support information, use the below command:

```
awplus# show tech-support system
```

Output The output of this command may include the result of the following commands:

```
show arp
show arp security
show arp security interface
show arp security statistics
show boot
show clock
show counter dhcp-client
show counter dhcp-relay
show counter dhcp-server
show counter log
show counter mail
show counter ntp
show counter ping-poll
show counter snmp-server
show counter stack
show cpu
show cpu history
show etherchannel
show etherchannel detail
show exception log
show interface
show interface brief
show ip bgp
show ip bgp neighbors
show ip bgp paths
show ip bgp summary
show ip dhcp snooping
show ip dhcp snooping acl
show ip dhcp snooping binding
show ip dhcp snooping interface
```

show ip dhcp snooping statistics
show ip igmp groups
show ip igmp interface
show ip igmp snooping mrouter vlan1 (see the show ip igmp snooping mrouter command)
show ip interface brief
show ip ospf
show ip ospf database
show ip ospf interface
show ip ospf neighbor
show ip ospf route
show ip pim sparse-mode bsr-router
show ip pim sparse-mode interface detail
show ip pim sparse-mode mroute detail
show ip pim sparse-mode neighbor
show ip pim sparse-mode nexthop
show ip pim sparse-mode rp mapping
show ip route
show ip source binding
show lacp-counter
show lacp sys-id
show license
show log
show log permanent
show memory
show memory allocations
show memory history
show memory pools
show ntp associations
show ntp status
show platform
show platform port
show running-config
show spanning-tree
show stack
show stack detail (see the show stack command)
show stack full-debug
show startup-config
show static-channel-group
show system
show system environment
show system pluggable
show users
show vlan brief (see the show vlan command)
show vrrp

Related Commands show debugging nsm

speed (async)

This command changes the console speed from the switch. Note that a change in console speed is applied for subsequent console sessions. Exit the current session to enable the console speed change. See the [Usage](#) below the syntax for further information about this command.

Syntax `speed <console-speed-in-bps>`

Parameter	Description														
<code><console-speed-in-bps></code>	<table> <tr> <td><code><1200></code></td> <td>1200 Baud</td> </tr> <tr> <td><code><2400></code></td> <td>2400 Baud</td> </tr> <tr> <td><code><9600></code></td> <td>9600 Baud</td> </tr> <tr> <td><code><19200></code></td> <td>19200 Baud</td> </tr> <tr> <td><code><38400></code></td> <td>38400 Baud</td> </tr> <tr> <td><code><57600></code></td> <td>57600 Baud</td> </tr> <tr> <td><code><115200></code></td> <td>115200 Baud</td> </tr> </table> Console speed Baud rate in bps (bits per second).	<code><1200></code>	1200 Baud	<code><2400></code>	2400 Baud	<code><9600></code>	9600 Baud	<code><19200></code>	19200 Baud	<code><38400></code>	38400 Baud	<code><57600></code>	57600 Baud	<code><115200></code>	115200 Baud
<code><1200></code>	1200 Baud														
<code><2400></code>	2400 Baud														
<code><9600></code>	9600 Baud														
<code><19200></code>	19200 Baud														
<code><38400></code>	38400 Baud														
<code><57600></code>	57600 Baud														
<code><115200></code>	115200 Baud														

Default The default console speed baud rate is 9600 bps.

Mode Line Configuration

Usage This command is used to change the console speed. Set the console speed to match the transmission rate of the device connected to the **ASYNC0** or **CONSOLE** port respectively on your switch.

Examples To set the console speed to 115200 bps from the switch, enter the following commands:

```
awplus# configure line 0
awplus(config-line)# speed 115200
```

Then exit your current session and login to enable the console speed change as shown below:

```
awplus(config-line)# exit
awplus(config)# exit
awplus# exit
```

(The changed console speed of 115200 bps is then applied after exiting the session before the login).

```
awplus login:
Password:
awplus>
```

Related Commands [show running-config](#)
[show startup-config](#)
[speed](#)

system territory

This command sets the territory of the system.

Use the **no** variant of this command to return the territory to its default setting of `japan`.

For information on output options, see [“Controlling “show” Command Output” on page 1.35](#).

Syntax `system territory {australia|nz|europe|japan|usa|china|korea}`
`no system territory`

Parameter	Description
<code>australia</code>	Australia
<code>nz</code>	New Zealand
<code>europe</code>	Europe
<code>japan</code>	Japan
<code>usa</code>	USA
<code>china</code>	China
<code>korea</code>	Korea

Mode Global Configuration

Example To set the territory to USA, enter the command:

```
awplus(config)# system territory usa
```

Validation Commands `show system`

terminal monitor

Use this command to display debugging output on a terminal.

To display the cursor after a line of debugging output, press the Enter key.

Use the command **terminal no monitor** to stop displaying debugging output on the terminal, or use the timeout option to stop displaying debugging output on the terminal after a set time.

Syntax `terminal monitor [<1-60>]`

`terminal no monitor`

Parameter	Description
<1-60>	Set a timeout between 1-60 minutes for terminal output.

Default Disabled

Mode Privileged Exec

Examples To display debugging output on a terminal, enter the command:

```
awplus# terminal monitor
```

To specify timeout of debugging output after 60 seconds, enter the command:

```
awplus# terminal monitor 60
```

To stop displaying debugging output on the terminal, use the command:

```
awplus# terminal no monitor
```

Related Commands All debug commands

undebug all

This command applies the functionality of the [no debug all command on page 8.18](#).

undebug nsm

This command specifies a set of debug options for use by Allied Telesis authorized service personnel only. This command disables the debugging option for the nsm events.

Syntax `undebug nsm [all|events|ha|kernel]`

Mode Privileged Exec

Related Commands [show debugging nsm](#)
[debug nsm](#)

undebbug nsm packet

This command specifies a set of debug options for use by Allied Telesis authorized service personnel only. This command disables the debugging option for the nsm packet.

Syntax `undebbug nsm packet [recv|send] [detail]`

Mode Privileged Exec

Related Commands `show debugging nsm`
`debug nsm`

Chapter 9: Debugging and Logging



Introduction.....	9.2
Debugging.....	9.2
Logging to terminal.....	9.2
Turning off debugging.....	9.2
Logging.....	9.3
Log Outputs.....	9.3

Introduction

AlliedWare Plus™ has a comprehensive debugging and logging facility in various protocols and components. This chapter describes how to start/stop debugging and logging. For detailed descriptions of the commands used to configure logging, see [Chapter 10, Logging Commands](#).

Debugging

Many protocols have debug commands. Debug commands, when used with the parameters, log protocol-specific information. For example, using the **debug mstp protocol** command, results in the device writing all debugging messages generated by the MSTP algorithm to the logging system.

On using a debug command, the protocol continues to generate output until the **no** parameter is used with the command. To specify where logging output is sent, and the level of events to log, use the **log** commands in [Chapter 10, Logging Commands](#).

Logging to terminal

To start debugging to the terminal:

Step 1: Turn on the debug options by using the relevant debug command.

Step 2: Run the terminal monitor command.

```
awplus> enable
awplus# configure terminal
awplus(config)# debug <protocol> (parameter)
awplus(config)# exit
awplus# terminal monitor
```

Sample Output

This is a sample output of the **debug rsvp events** command displayed on the terminal:

```
awplus#terminal monitor
Dec  2 16:41:49 localhost RSVP[6518]: RSVP: RSVP message sent to
10.10.23.60/32 via interface vlan2
Dec  2 16:41:57 localhost RSVP[6518]: RSVP: Received an RSVP message
of type RSVP Reservation from 192.168.0.60 via interface vlan2
Dec  2 16:41:57 localhost RSVP[6518]: RSVP: Received a RESV message
from 10.10.23.60/32
```

Turning off debugging

To turn off debugging, use the **no debug** or **undebug** command. When a protocol is specified with the **no debug** or **undebug** commands, debugging is stopped for the specified protocol. To stop all debugging, use the **all** parameter with these commands.

```
awplus(config)# no debug bgp events
or
awplus#undebug all
```

Logging

Protocols generate important debugging messages by default, and send them to the logging system. Additional more detailed messages can be generated by enabling debugging (“[Debugging](#)” on page 9.2).

Messages can be filtered based on: the program that generated the message, the severity level of the message, the type of facility that generated the message, substrings within the message text. The severity levels in order are:

- emergencies
- alerts
- critical
- errors
- warnings
- notifications
- informational
- debugging

The facility categories are:

- auth Security/authorization messages
- authpriv Security/authorization messages (private)
- cron Clock daemon
- daemon System daemons
- ftp FTP daemon
- kern Kernel messages
- lpr Line printer subsystem
- mail Mail system
- news Network news subsystem
- syslog Messages generated internally by syslogd
- user Random user-level messages
- uucp UUCP subsystem

Log Outputs

The following types of logging output are available:

- buffered
- permanent
- terminal
- console
- host
- email

Buffered log The buffered log is a file stored in RAM on the device. Because it is stored in RAM its content does not survive a reboot of the device. A device can only have one instance of the buffered log. The buffered log is enabled by default and has a filter to include messages with a severity level of 'notifications' and above. The buffered log can be enabled or disabled using the commands:

log buffered

```
no log buffered
```

Additional filters can be added and removed using the commands described in [log buffered \(filter\)](#):

```
log buffered {facility|level|msgtext|program}
```

```
no log buffered {facility|level|msgtext|program}
```

The following log buffered commands are available:

show log	Displays the entire contents of the buffered log
show log tail	Displays the 10 most recent entries in the buffered log.
show log tail <10-250>	Displays a specified number of the most recent entries in the buffered log.
show log config	Displays the configuration of all log outputs
log buffered size	Specify the amount of memory the buffered log may use.
clear log	Remove the contents of the buffered log (and permanent log if it exists)
clear log buffered	Remove the contents of the buffered log only
default log buffered	Restore the buffered log to its default configuration

Permanent log The permanent log is a file stored in NVS on the device. This output type is only available on devices that have NVS. The contents on the permanent log is retained over a reboot. A device can only have one instance of the permanent log. The permanent log is enabled by default and has a filter to include messages with a severity level of 'warning' and above. The permanent log can be disabled using the command:

```
no log permanent
```

Additional filters can be added and removed using the commands described in [log permanent \(filter\)](#):

```
log permanent {facility|level|msgtext|program}
```

```
no log permanent {facility|level|msgtext|program}
```

Table 9-1: Permanent log commands

Command	Description
show log permanent	Display the entire contents of the permanent log
show log permanent tail	Display the 10 most recent entries in the permanent log
show log permanent tail <10-250>	Display a specified number of the most recent entries in the permanent log
show log config	Display the configuration of all log outputs
log permanent size	Specify the amount of memory the permanent log may use

Table 9-1: Permanent log commands (cont.)

Command	Description
<code>clear log</code>	Remove the contents of the buffered log and permanent log
<code>clear log permanent</code>	Remove the contents of the permanent log only
<code>default log permanent</code>	Restore the permanent log to its default configuration

Host log A host log sends log messages to a remote syslog server. A device may have many syslog hosts configured. To configure or remove a host use the commands:

`log host <ip-addr>`

`no log host <ip-addr>`

where *<ip-addr>* is the IP address of the remote syslog server.

There are no default filters associated with host outputs when they are created. Filters can be added and removed with the [log host \(filter\) command on page 10.24](#).

It is not possible to view the log messages sent to this type of output as they are not retained on the device. They must be viewed on the remote device. The other host log commands are:

<code>show log config</code>	Displays the configuration of all log outputs
<code>log host time</code>	Adjust the time information in messages to a time zone other than the one configured on this device
<code>default log host <ip-address></code>	Restores the device default settings for log sent to a remote syslog server.

Email log An email log sends log messages to an email address. A device may have many email logs configured. To configure or remove an email log use the commands:

`log email <email-address>`

`no log email <email-address>`

where *<email-address>* is the destination email address.

There are no default filters associated with email outputs when they are created. Filters can be added and removed with the commands described in [log email \(filter\)](#):

`log email <email-address> {facility|level|msgtext|program}`

`no log email <email-address> {facility|level|msgtext|program}`

It is not possible to view the log messages sent to this type of output as they are not retained on the device. They must be viewed by the email recipient.

The other email log commands are:

<code>show log config</code>	Displays the configuration of all log outputs
<code>log email time</code>	Adjust the time information in messages to a time zone other than the one configured on this device
<code>default log email</code>	Restores the device default settings for log messages sent to an email address.

Note An email server and “from” address must be configured on the device in order for email logs to work:



- `mail from <email-address>`
- `mail smtpserver <ip-address>`

where the `<email-address>` is the ‘From:’ field on the sent email, and the `<ip-address>` is the email's destination SMTP server.

Email logs are sent in batches of approximately 20 messages and have the subject line “Log messages”

Chapter 10: Logging Commands



Command List	10.2
clear exception log.....	10.2
clear log	10.2
clear log buffered	10.3
clear log permanent.....	10.3
default log buffered.....	10.4
default log console	10.4
default log email.....	10.5
default log host.....	10.5
default log monitor	10.6
default log permanent.....	10.7
exception coredump size.....	10.8
log buffered	10.9
log buffered (filter)	10.10
log buffered size.....	10.13
log console.....	10.13
log console (filter).....	10.15
log email	10.18
log email (filter)	10.19
log email time.....	10.22
log host	10.23
log host (filter)	10.24
log host time.....	10.27
log monitor (filter).....	10.29
log permanent.....	10.32
log permanent (filter)	10.33
log permanent size.....	10.36
log-rate-limit nsm	10.37
show counter log.....	10.38
show exception log.....	10.39
show log.....	10.40
show log config	10.42
show log permanent.....	10.45
show running-config log.....	10.48

Command List

This chapter provides an alphabetical reference of commands used to configure logging.

clear exception log

This command resets the contents of the exception log, but does not remove the associated core files.

Note  When this command is used within a virtual chassis stack (VCS), it will remove the contents of the exception logs in all stack members.

Syntax `clear exception log`

Mode Privileged Exec

Example

```
awplus# clear exception log
```

clear log

This command removes the contents of the buffered and permanent logs.

Note  When this command is used within a virtual chassis stack (VCS), it will remove the contents of the buffered and permanent logs in all stack members.

Syntax `clear log`

Mode Privileged Exec

Example To delete the contents of the buffered and permanent log use the command:

```
awplus# clear log
```

**Validation
Commands** `show log`

Related Commands `clear log buffered`
`clear log permanent`

clear log buffered

This command removes the contents of the buffered log.

Note  When this command is used within a virtual chassis stack (VCS), it will remove the contents of the buffered logs in all stack members.

Syntax `clear log buffered`

Mode Privileged Exec

Example To delete the contents of the buffered log use the following commands:

```
awplus# configure terminal
awplus(config)# clear log buffered
```

**Validation
Commands** `show log`

Related Commands `clear log`
`clear log permanent`

clear log permanent

This command removes the contents of the permanent log.

Note  When this command is used within a virtual chassis stack (VCS), it will remove the contents of the buffered logs in all stack members.

Syntax `clear log permanent`

Mode Privileged Exec

Example To delete the contents of the permanent log use the following commands:

```
awplus# configure terminal
awplus(config)# clear log permanent
```

**Validation
Commands** `show log`

Related Commands `clear log`
`clear log buffered`

default log buffered

This command restores the default settings for the buffered log stored in RAM. By default the size of the buffered log is 50 kB and it accepts messages with the severity level of “warnings” and above.

Syntax `default log buffered`

Default The buffered log is enabled by default.

Mode Global Configuration

Example To restore the buffered log to its default settings use the following commands:

```
awplus# configure terminal
awplus(config)# default log buffered
```

**Validation
Commands** `show log config`

Related Commands `log buffered`
`log buffered size`

default log console

This command restores the default settings for log messages sent to the terminal when a `log console` command is issued. By default all messages are sent to the console when a `log console` command is issued.

Syntax `default log console`

Mode Global Configuration

Example To restore the log console to its default settings use the following commands:

```
awplus# configure terminal
awplus(config)# default log console
```

**Validation
Commands** `show log config`

Related Commands `log console`
`log console (filter)`

default log email

This command restores the default settings for log messages sent to an email address. By default no filters are defined for email addresses. Filters must be defined before messages will be sent. This command also restores the remote syslog server time offset value to local (no offset).

Syntax `default log email <email-address>`

Parameter	Description
<code><email-address></code>	The email address to send log messages to

Mode Global Configuration

Example To restore the default settings for log messages sent to the email address `admin@alliedtelesis.com` use the following commands:

```
awplus# configure terminal
awplus(config)# default log email admin@alliedtelesis.com
```

Related Commands [show log config](#)

default log host

This command restores the default settings for log sent to a remote syslog server. By default no filters are defined for remote syslog servers. Filters must be defined before messages will be sent. This command also restores the remote syslog server time offset value to local (no offset).

Syntax `default log host <ip-addr>`

Parameter	Description
<code><ip-addr></code>	The IP address of a remote syslog server

Mode Global Configuration

Example To restore the default settings for messages sent to the remote syslog server with IP address `10.32.16.21` use the following commands:

```
awplus# configure terminal
awplus(config)# default log host 10.32.16.21
```

Validation Commands [show log config](#)

Related Commands [log email](#)

default log monitor

This command restores the default settings for log messages sent to the terminal when a [terminal monitor](#) command is used.

Syntax `default log monitor`

Default All messages are sent to the terminal when a [terminal monitor](#) command is used.

Mode Global Configuration

Example To restore the log monitor to its default settings use the following commands:

```
awplus# configure terminal
awplus(config)# default log monitor
```

Related Commands [log monitor \(filter\)](#)
[show log config](#)

default log permanent

This command restores the default settings for the permanent log stored in NVS. By default, the size of the permanent log is 50 kB and it accepts messages with the severity level of `warnings` and above.

Syntax `default log permanent`

Default The permanent log is enabled by default.

Mode Global Configuration

Example To restore the permanent log to its default settings use the following commands:

```
awplus# configure terminal
awplus(config)# default log permanent
```

Related Commands [log permanent](#)
[log permanent size](#)
[show log config](#)

exception coredump size

This command sets the size of core files, and can also be used to stop core files being created.

Use the **no** variant of this command to restore the core file size to its default (unlimited).

This setting only applies to processes created after this command has been executed, to ensure this is applied to all processes the system will need to be restarted.

Syntax `exception coredump size {none|small|medium|large|unlimited}`
`no exception coredump size`

Parameter	Description
<code>none</code>	Don't create corefiles
<code>small</code>	Create small corefiles
<code>medium</code>	Create medium corefiles
<code>large</code>	Create large corefiles (default)
<code>unlimited</code>	Create corefiles as large as necessary

Default Unlimited

Mode Global Configuration

Usage Core files are generated when a process crashes. The size of a core file can vary, its upper limit is controlled by this command. Files larger than this limit will be truncated by reducing the amount of stack and variable information stored.

Truncated core files may make debugging the failure difficult if not impossible. Reducing the amount of data stored in a core file is not recommended, however the facility is provided to reduce the amount of flash used.

Examples To restrict the size of the core file created, use the command:

```
awplus# configure terminal
awplus(config)# exception coredump size small
```

To restore the size of the core files created to the default of `unlimited`, use the command:

```
awplus# configure terminal
awplus(config)# no exception coredump size
```

log buffered

This command configures the device to store log messages in RAM. Messages stored in RAM are not retained on the device over a restart. Once the buffered log reaches its configured maximum allowable size old messages will be deleted to make way for new ones.

Syntax `log buffered`
`no log buffered`

Default The buffered log is configured by default.

Mode Global Configuration

Examples To configure the device to store log messages in RAM use the following commands:

```
awplus# configure terminal
awplus(config)# log buffered
```

To configure the device to not store log messages in a RAM buffer use the following commands:

```
awplus# configure terminal
awplus(config)# no log buffered
```

**Validation
Commands** `show log config`

Related Commands `default log buffered`
`log buffered (filter)`
`log buffered size`

log buffered (filter)

Use this command to create a filter to select messages to be sent to the buffered log. Selection can be based on the priority/ severity of the message, the program that generated the message, the logging facility used, a sub-string within the message or a combination of some or all of these.

The **no** variant of this command removes the corresponding filter, so that the specified messages are no longer sent to the buffered log.

Syntax `log buffered [level <level>] [program <program-name>]
[facility <facility>] [msgtext <text-string>]`

`no log buffered [level <level>] [program <program-name>]
[facility <facility>] [msgtext <text-string>]`

Parameter	Description																
level	Filter messages to the buffered log by severity level.																
<level>	The minimum severity of message to send to the buffered log. The level can be specified as one of the following numbers or level names, where 0 is the highest severity and 7 is the lowest severity: <table data-bbox="683 958 1276 1267"> <tr> <td>0 emergencies:</td> <td>System is unusable</td> </tr> <tr> <td>1 alerts</td> <td>Action must be taken immediately</td> </tr> <tr> <td>2 critical</td> <td>Critical conditions</td> </tr> <tr> <td>3 errors</td> <td>Error conditions</td> </tr> <tr> <td>4 warnings</td> <td>Warning conditions</td> </tr> <tr> <td>5 notices</td> <td>Normal, but significant, conditions</td> </tr> <tr> <td>6 informational</td> <td>Informational messages</td> </tr> <tr> <td>7 debugging</td> <td>Debug-level messages</td> </tr> </table>	0 emergencies:	System is unusable	1 alerts	Action must be taken immediately	2 critical	Critical conditions	3 errors	Error conditions	4 warnings	Warning conditions	5 notices	Normal, but significant, conditions	6 informational	Informational messages	7 debugging	Debug-level messages
0 emergencies:	System is unusable																
1 alerts	Action must be taken immediately																
2 critical	Critical conditions																
3 errors	Error conditions																
4 warnings	Warning conditions																
5 notices	Normal, but significant, conditions																
6 informational	Informational messages																
7 debugging	Debug-level messages																

Parameter (cont.)	Description (cont.)
<code>program</code>	Filter messages to the buffered log by program. Include messages from a specified program in the buffered log.
<code><program-name></code>	<p>The name of a program to log messages from, either one of the following predefined program names (not case-sensitive), or another program name (case-sensitive) that you find in the log output.</p> <ul style="list-style-type: none"> <code>rip</code> Routing Information Protocol (RIP) <code>ripng</code> Routing Information Protocol - next generation (RIPng) <code>ospf</code> Open Shortest Path First (OSPF) <code>ospfv3</code> Open Shortest Path First (OSPF) version 3 (OSPFv3) <code>bgp</code> Border Gateway Protocol (BGP) <code>rsvp</code> Resource Reservation Protocol (RSVP) <code>pim-dm</code> Protocol Independent Multicast - Dense Mode (PIM-DM) <code>pim-sm</code> Protocol Independent Multicast - Sparse Mode (PIM-SM) <code>dot1x</code> IEEE 802.1X Port-Based Access Control <code>lacp</code> Link Aggregation Control Protocol (LACP) <code>stp</code> Spanning Tree Protocol (STP) <code>rstp</code> Rapid Spanning Tree Protocol (RSTP) <code>mstp</code> Multiple Spanning Tree Protocol (MSTP) <code>imi</code> Integrated Management Interface (IMI) <code>imish</code> Integrated Management Interface Shell (IMISH) <code>epsr</code> Ethernet Protection Switched Rings (EPSR) <code>irdp</code> ICMP Router Discovery Protocol (IRDP) <code>rmon</code> Remote Monitoring <code>loopprot</code> Loop Protection <code>poe</code> Power-inline (Power over Ethernet) <code>dhcpcsn</code> DHCP snooping (DHCP SN)
<code>facility</code>	Filter messages to the buffered log by syslog facility.
<code><facility></code>	<p>Specify one of the following syslog facilities to include messages from in the buffered log:</p> <ul style="list-style-type: none"> <code>kern</code> Kernel messages <code>user</code> Random user-level messages <code>mail</code> Mail system <code>daemon</code> System daemons <code>auth</code> Security/authorization messages <code>syslog</code> Messages generated internally by syslogd <code>lpr</code> Line printer subsystem <code>news</code> Network news subsystem <code>uucp</code> UUCP subsystem <code>cron</code> Clock daemon <code>authpriv</code> Security/authorization messages (private) <code>ftp</code> FTP daemon

Parameter (cont.)	Description (cont.)
msgtext	Select messages containing a certain text string (maximum 128 characters).
<text-string>	A text string to match (maximum 128 characters). This is case sensitive, and must be the last text on the command line.

Default By default the buffered log has a filter to select messages whose severity level is "notices (5)" or higher. This filter may be removed using the **no** variant of this command.

Mode Global Configuration

Examples To add a filter to send all messages generated by BGP that have a severity of notices or higher to the buffered log use the following commands:

```
awplus# configure terminal
awplus(config)# log buffered level notices program bgp
```

To add a filter to send all messages containing the text "Bridging initialization", to the buffered log use the following commands:

```
awplus# configure terminal
awplus(config)# log buffered msgtext Bridging initialization
```

To remove a filter that sends all messages generated by BGP that have a severity of notices or higher to the buffered log use the following commands:

```
awplus# configure terminal
awplus(config)# no log buffered level notices program bgp
```

To remove a filter that sends all messages containing the text "Bridging initialization", to the buffered log use the following commands:

```
awplus# configure terminal
awplus(config)# no log buffered msgtext Bridging initialization
```

Validation Commands show log config

Related Commands default log buffered
log buffered
log buffered size

log buffered size

This command configures the amount of memory that the buffered log is permitted to use. Once this memory allocation has been filled old messages will be deleted to make room for new messages.

Syntax `log buffered size <50-250>`

Parameter	Description
<code><50-250></code>	Size of the RAM log in kilobytes

Mode Global Configuration

Example To allow the buffered log to use up to 100 kB of RAM use the following commands:

```
awplus# configure terminal
awplus(config)# log buffered size 100
```

Validation Commands `show log config`

Related Commands `default log buffered`
`log buffered`

log console

This command configures the device to send log messages to consoles. The console log is configured by default to send messages to the devices main console port.

Use the **no** variant of this command to configure the device not to send log messages to consoles.

Syntax `log console`
`no log console`

Mode Global Configuration

Examples To configure the device to send log messages use the following commands:

```
awplus# configure terminal
awplus(config)# log console
```

To configure the device not to send log messages in all consoles use the following commands:

```
awplus# configure terminal
```

```
awplus(config)# no log console
```

**Validation
Commands** [show log config](#)

Related Commands [log console \(filter\)](#)

log console (filter)

This command creates a filter to select messages to be sent to all consoles when the log console command is given. Selection can be based on the priority/severity of the message, the program that generated the message, the logging facility used, a sub-string within the message or a combination of some or all of these.

Syntax `log console [level <level>] [program <program-name>]
 [facility <facility>] [msgtext <text-string>]`

`no log console [level <level>] [program <program-name>]
 [facility <facility>] [msgtext <text-string>]`

Parameter	Description																
level	Filter messages by severity level.																
<level>	<p>The minimum severity of message to send. The level can be specified as one of the following numbers or level names, where 0 is the highest severity and 7 is the lowest severity:</p> <table> <tbody> <tr> <td>0 emergencies:</td> <td>System is unusable</td> </tr> <tr> <td>1 alerts</td> <td>Action must be taken immediately</td> </tr> <tr> <td>2 critical</td> <td>Critical conditions</td> </tr> <tr> <td>3 errors</td> <td>Error conditions</td> </tr> <tr> <td>4 warnings</td> <td>Warning conditions</td> </tr> <tr> <td>5 notices</td> <td>Normal, but significant, conditions</td> </tr> <tr> <td>6 informational</td> <td>Informational messages</td> </tr> <tr> <td>7 debugging</td> <td>Debug-level messages</td> </tr> </tbody> </table>	0 emergencies:	System is unusable	1 alerts	Action must be taken immediately	2 critical	Critical conditions	3 errors	Error conditions	4 warnings	Warning conditions	5 notices	Normal, but significant, conditions	6 informational	Informational messages	7 debugging	Debug-level messages
0 emergencies:	System is unusable																
1 alerts	Action must be taken immediately																
2 critical	Critical conditions																
3 errors	Error conditions																
4 warnings	Warning conditions																
5 notices	Normal, but significant, conditions																
6 informational	Informational messages																
7 debugging	Debug-level messages																

Parameter (cont.)	Description (cont.)
<code>program</code>	Filter messages by program. Include messages from a specified program.
<code><program-name></code>	The name of a program to log messages from, either one of the following predefined program names (not case-sensitive), or another program name (case-sensitive) that you find in the log output. <ul style="list-style-type: none"> <code>rip</code> Routing Information Protocol (RIP) <code>ripng</code> Routing Information Protocol - next generation (RIPng) <code>ospf</code> Open Shortest Path First (OSPF) <code>ospfv3</code> Open Shortest Path First (OSPF) version 3 (OSPFv3) <code>bgp</code> Border Gateway Protocol (BGP) <code>rsvp</code> Resource Reservation Protocol (RSVP) <code>pim-dm</code> Protocol Independent Multicast - Dense Mode (PIM-DM) <code>pim-sm</code> Protocol Independent Multicast - Sparse Mode (PIM-SM) <code>dot1x</code> IEEE 802.1X Port-Based Access Control <code>lacp</code> Link Aggregation Control Protocol (LACP) <code>stp</code> Spanning Tree Protocol (STP) <code>rstp</code> Rapid Spanning Tree Protocol (RSTP) <code>mstp</code> Multiple Spanning Tree Protocol (MSTP) <code>imi</code> Integrated Management Interface (IMI) <code>imish</code> Integrated Management Interface Shell (IMISH) <code>epsr</code> Ethernet Protection Switched Rings (EPSR) <code>irdp</code> ICMP Router Discovery Protocol (IRDP) <code>rmon</code> Remote Monitoring <code>loopprot</code> Loop Protection <code>poe</code> Power-inline (Power over Ethernet) <code>dhcpcsn</code> DHCP snooping (DHPCPSN)
<code>facility</code>	Filter messages to the buffered log by syslog facility.
<code><facility></code>	Specify one of the following syslog facilities to include messages from: <ul style="list-style-type: none"> <code>kern</code> Kernel messages <code>user</code> Random user-level messages <code>mail</code> Mail system <code>daemon</code> System daemons <code>auth</code> Security/authorization messages <code>syslog</code> Messages generated internally by syslogd <code>lpr</code> Line printer subsystem <code>news</code> Network news subsystem <code>uucp</code> UUCP subsystem <code>cron</code> Clock daemon <code>authpriv</code> Security/authorization messages (private) <code>ftp</code> FTP daemon
<code>msgtext</code>	Select messages containing a certain text string
<code><text-string></code>	A text string to match. This is case sensitive, and must be the last text on the command line.

Default By default the buffered log has a filter to select messages whose severity level is `critical` or higher. This filter may be removed using the `no` variant of this command. This filter may be removed and replaced by filters that are more selective.

Mode Global Configuration

Examples To create a filter to send all messages generated by MSTP that have a severity of `info` or higher to console instances where the log console command has been given, remove the default filter that includes everything use the following commands:

```
awplus# configure terminal
awplus(config)# log console level info program mstp
```

and then use the command:

```
awplus(config)# log console level info program mstp
```

To create a filter to send all messages containing the text "Bridging initialization" to console instances where the log console command has been given use the following commands:

```
awplus# configure terminal
awplus(config)# log console msgtext "Bridging initialization"
```

To remove a filter that sends all messages generated by BGP that have a severity of `notices` or higher to consoles use the following commands:

```
awplus# configure terminal
awplus(config)# no log console level notices program bgp
```

To remove a default filter that includes sending `critical`, `alert` and `emergency` level messages to the console use the following commands:

```
awplus# configure terminal
awplus(config)# no log console level critical
```

**Validation
Commands** `show log config`

Related Commands `log console`

log email

This command configures the device to send log messages to an email address. The email address is specified in this command.

Syntax `log email <email-address>`

Parameter	Description
<code><email-address></code>	The email address to send log messages to

Default By default no filters are defined for email log targets. Filters must be defined before messages will be sent.

Mode Global Configuration

Example To have log messages emailed to the email address `admin@alliedtelesis.com` use the following commands:

```
awplus# configure terminal
awplus(config)# log email admin@alliedtelesis.com
```

**Validation
Commands** `show log config`

Related Commands `default log email`
`log email`

log email (filter)

This command creates a filter to select messages to be sent to an email address. Selection can be based on the priority/ severity of the message, the program that generated the message, the logging facility used, a sub-string within the message or a combination of some or all of these.

The **no** variant of this command configures the device to no longer send log messages to a specified email address. All configuration relating to this log target will be removed.

Syntax

```
log email <email-address> [level <level>] [program <program-name>]
    [facility <facility>] [msgtext <text-string>]

no log email <email-address> [level <level>] [program <program-name>]
    [facility <facility>] [msgtext <text-string>]
```

Parameter	Description																
<email-address>	The email address to send logging messages to																
level	Filter messages by severity level.																
<level>	<p>The minimum severity of messages to send. The level can be specified as one of the following numbers or level names, where 0 is the highest severity and 7 is the lowest severity:</p> <table> <tr> <td>0 emergencies:</td> <td>System is unusable</td> </tr> <tr> <td>1 alerts</td> <td>Action must be taken immediately</td> </tr> <tr> <td>2 critical</td> <td>Critical conditions</td> </tr> <tr> <td>3 errors</td> <td>Error conditions</td> </tr> <tr> <td>4 warnings</td> <td>Warning conditions</td> </tr> <tr> <td>5 notices</td> <td>Normal, but significant, conditions</td> </tr> <tr> <td>6 informational</td> <td>Informational messages</td> </tr> <tr> <td>7 debugging</td> <td>Debug-level messages</td> </tr> </table>	0 emergencies:	System is unusable	1 alerts	Action must be taken immediately	2 critical	Critical conditions	3 errors	Error conditions	4 warnings	Warning conditions	5 notices	Normal, but significant, conditions	6 informational	Informational messages	7 debugging	Debug-level messages
0 emergencies:	System is unusable																
1 alerts	Action must be taken immediately																
2 critical	Critical conditions																
3 errors	Error conditions																
4 warnings	Warning conditions																
5 notices	Normal, but significant, conditions																
6 informational	Informational messages																
7 debugging	Debug-level messages																
program	Filter messages by program. Include messages from a specified program in the log.																

Parameter (cont.)	Description (cont.)
<i><program-name></i>	The name of a program to log messages from, either one of the following predefined program names (not case-sensitive), or another program name (case -sensitive) that you find in the log output. rip Routing Information Protocol (RIP) ripng Routing Information Protocol - next generation (RIPng) ospf Open Shortest Path First (OSPF) ospfv3 Open Shortest Path First (OSPF) version 3 (OSPFv3) bgp Border Gateway Protocol (BGP) rsvp Resource Reservation Protocol (RSVP) pim-dm Protocol Independent Multicast - Dense Mode (PIM-DM) pim-sm Protocol Independent Multicast - Sparse Mode (PIM-SM) dot1x IEEE 802.1X Port-Based Access Control lacp Link Aggregation Control Protocol (LACP) stp Spanning Tree Protocol (STP) rstp Rapid Spanning Tree Protocol (RSTP) mstp Multiple Spanning Tree Protocol (MSTP) imi Integrated Management Interface (IMI) imish Integrated Management Interface Shell (IMISH) epsr Ethernet Protection Switched Rings (EPSR) irdp ICMP Router Discovery Protocol (IRDP) rmon Remote Monitoring loopprot Loop Protection poe Power-inline (Power over Ethernet) dhcpsn DHCP snooping (DHCP SN)
<i>facility</i>	Filter messages to the log by syslog facility.
<i><facility></i>	Specify one of the following syslog facilities to include messages from in the log: kern Kernel messages user Random user-level messages mail Mail system daemon System daemons auth Security/authorization messages syslog Messages generated internally by syslogd lpr Line printer subsystem news Network news subsystem uucp UUCP subsystem cron Clock daemon authpriv Security/authorization messages (private) ftp FTP daemon
<i>msgtext</i>	Select messages containing a certain text string
<i><text-string></i>	A text string to match. This is case sensitive, and must be the last text on the command line.

Mode Global Configuration

Examples To create a filter to send all messages generated by BGP that have a severity of notices or higher to the email address `admin@homebase.com` use the following commands:

```
awplus# configure terminal
awplus(config)# log email admin@homebase.com level notices
program bgp
```

To create a filter to send all messages containing the text "Bridging initialization", to the email address `admin@homebase.com` use the following commands:

```
awplus# configure terminal
awplus(config)# log email admin@homebase.com msgtext
"Bridging initialization"
```

To create a filter to send messages with a severity level of `informational` and above to the email address `admin@alliedtelesis.com` use the following commands:

```
awplus# configure terminal
awplus(config)# log email admin@alliedtelesis.com level
informational
```

To stop the device emailing log messages emailed to the email address `admin@alliedtelesis.com` use the following commands:

```
awplus# configure terminal
awplus(config)# no log email admin@homebase.com
```

To remove a filter that sends all messages generated by BGP that have a severity of notices or higher to the email address `admin@homebase.com` use the following commands:

```
awplus# configure terminal
awplus(config)# no log email admin@homebase.com level
notices program bgp
```

To remove a filter that sends messages with a severity level of `informational` and above to the email address `admin@alliedtelesis.com` use the following commands:

```
awplus# configure terminal
awplus(config)# no log email admin@alliedtelesis.com level
informational
```

Related Commands [default log email](#)
[log email](#)
[show log config](#)

log email time

This command configures the time used in messages sent to an email address. If the syslog server is in a different time zone to your switch then the time offset can be configured using either the **utc-offset** parameter option keyword or the **local-offset** parameter option keyword, where **utc-offset** is the time difference from UTC (Universal Time, Coordinated) and **local-offset** is the difference from local time.

Syntax `log email <email-address> time {local|local-offset|utc-offset
{plus|minus}<0-24>}`

Parameter	Description
<email-address>	The email address to send log messages to
time	Specify the time difference between the email recipient and the switch you are configuring.
local	The switch is in the same time zone as the email recipient
local-offset	The switch is in a different time zone to the email recipient. Use the plus or minus keywords and specify the difference (offset) from local time of the switch to the email recipient in hours.
utc-offset	The switch is in a different time zone to the email recipient. Use the plus or minus keywords and specify the difference (offset) from UTC time of the switch to the email recipient in hours.
plus	Negative offset (difference) from the switch to the email recipient.
minus	Positive offset (difference) from the switch to the email recipient.
<0-24>	World Time zone offset in hours

Default The default is **local** time.

Mode Global Configuration

Usage Use the **local** option if the email recipient is in the same time zone as this device. Messages will display the time as on the local device when the message was generated.

Use the **offset** option if the email recipient is in a different time zone to this device. Specify the time offset of the email recipient in hours. Messages will display the time they were generated on this device but converted to the time zone of the email recipient.

Examples To send messages to the email address `test@home.com` in the same time zone as the switch's local time zone, use the following commands:

```
awplus# configure terminal
awplus(config)# log email admin@base.com time local 0
```

To send messages to the email address `admin@base.com` with the time information converted to the time zone of the email recipient, which is 3 hours ahead of the switch's local time zone, use the following commands:

```
awplus# configure terminal
awplus(config)# log email admin@base.com time local-offset
plus 3
```

To send messages to the email address `user@remote.com` with the time information converted to the time zone of the email recipient, which is 3 hours behind the switch's UTC time zone, use the following commands:

```
awplus# configure terminal
awplus(config)# log email user@remote.com time utc-offset
                minus 3
```

**Validation
Commands** `show log config`

Related Commands `default log buffered`

log host

This command configures the device to send log messages to a remote syslog server via UDP port 514. The IP address of the remote server must be specified. By default no filters are defined for remote syslog servers. Filters must be defined before messages will be sent.

Syntax `log host <ip-addr>`
`no log host <ip-addr>`

Parameter	Description
<code><ip-addr></code>	The IP address of a remote syslog server in dotted decimal format A.B.C.D

Mode Global Configuration

Examples To configure the device to send log messages to a remote syslog server with IP address 10.32.16.99 use the following commands:

```
awplus# configure terminal
awplus(config)# log host 10.32.16.99
```

To stop the device from sending log messages to the remote syslog server with IP address 10.32.16.99 use the following commands:

```
awplus# configure terminal
awplus(config)# no log host 10.32.16.99
```

**Validation
Commands** `show log config`

Related Commands `default log host`

log host (filter)

This command creates a filter to select messages to be sent to a remote syslog server. Selection can be based on the priority/severity of the message, the program that generated the message, the logging facility used, a substring within the message or a combination of some or all of these.

The **no** variant of this command configures the device to no longer send log messages to a remote syslog server. The IP address of the syslog server must be specified. All configuration relating to this log target will be removed.

Syntax `log host <ip-addr> [level <level>] [program <program-name>]
[facility <facility>] [msgtext <text-string>]`

`no log host <ip-addr> [level <level>] [program <program-name>]
[facility <facility>] [msgtext <text-string>]`

Parameter	Description																
<code><ip-addr></code>	The IP address of a remote syslog server																
<code>level</code>	Filter messages by severity level.																
<code><level></code>	The minimum severity of messages to send. The level can be specified as one of the following numbers or level names, where 0 is the highest severity and 7 is the lowest severity: <table border="0" style="margin-left: 20px;"> <tr> <td>0 emergencies:</td> <td>System is unusable</td> </tr> <tr> <td>1 alerts</td> <td>Action must be taken immediately</td> </tr> <tr> <td>2 critical</td> <td>Critical conditions</td> </tr> <tr> <td>3 errors</td> <td>Error conditions</td> </tr> <tr> <td>4 warnings</td> <td>Warning conditions</td> </tr> <tr> <td>5 notices</td> <td>Normal, but significant, conditions</td> </tr> <tr> <td>6 informational</td> <td>Informational messages</td> </tr> <tr> <td>7 debugging</td> <td>Debug-level messages</td> </tr> </table>	0 emergencies:	System is unusable	1 alerts	Action must be taken immediately	2 critical	Critical conditions	3 errors	Error conditions	4 warnings	Warning conditions	5 notices	Normal, but significant, conditions	6 informational	Informational messages	7 debugging	Debug-level messages
0 emergencies:	System is unusable																
1 alerts	Action must be taken immediately																
2 critical	Critical conditions																
3 errors	Error conditions																
4 warnings	Warning conditions																
5 notices	Normal, but significant, conditions																
6 informational	Informational messages																
7 debugging	Debug-level messages																
<code>program</code>	Filter messages by program. Include messages from a specified program in the log.																

Parameter (cont.)	Description (cont.)
<i><program-name></i>	The name of a program to log messages from, either one of the following predefined program names (not case-sensitive), or another program name (case-sensitive) that you find in the log output.
rip	Routing Information Protocol (RIP)
ripng	Routing Information Protocol - next generation (RIPng)
ospf	Open Shortest Path First (OSPF)
ospfv3	Open Shortest Path First (OSPF) version 3 (OSPFv3)
bgp	Border Gateway Protocol (BGP)
rsvp	Resource Reservation Protocol (RSVP)
pim-dm	Protocol Independent Multicast - Dense Mode (PIM-DM)
pim-sm	Protocol Independent Multicast - Sparse Mode (PIM-SM)
pim-smv6	Protocol Independent Multicast - Sparse Mode version 6 (PIM-SMv6)
dot1x	IEEE 802.1X Port-Based Access Control
lacp	Link Aggregation Control Protocol (LACP)
stp	Spanning Tree Protocol (STP)
rstp	Rapid Spanning Tree Protocol (RSTP)
mstp	Multiple Spanning Tree Protocol (MSTP)
imi	Integrated Management Interface (IMI)
imish	Integrated Management Interface Shell (IMISH)
epsr	Ethernet Protection Switched Rings (EPSR)
irdp	ICMP Router Discovery Protocol (IRDP)
rmon	Remote Monitoring
loopprot	Loop Protection
poe	Power-inline (Power over Ethernet)
dhcpsn	DHCP snooping (DHCP SN)
<i>facility</i>	Filter messages to the log by syslog facility.
<i><facility></i>	Specify one of the following syslog facilities to include messages from in the log:
kern	Kernel messages
user	Random user-level messages
mail	Mail system
daemon	System daemons
auth	Security/authorization messages
syslog	Messages generated internally by syslogd
lpr	Line printer subsystem
news	Network news subsystem
uucp	UUCP subsystem
cron	Clock daemon
authpriv	Security/authorization messages (private)
ftp	FTP daemon
<i>msgtext</i>	Select messages containing a certain text string
<i><text-string></i>	A text string to match. This is case sensitive, and must be the last text on the command line.

Mode Global Configuration

Examples To create a filter to send all messages generated by BGP that have a severity of `notices` or higher to a remote syslog server with IP address `10.32.16.21` use the following commands:

```
awplus# configure terminal
awplus(config)# log host 10.32.16.21 level notices program bgp
```

To create a filter to send all messages containing the text `"Bridging initialization"`, to a remote syslog server with IP address `10.32.16.21` use the following commands:

```
awplus# configure terminal
awplus(config)# log host 10.32.16.21 msgtext "Bridging
initialization"
```

To create a filter to send messages with a severity level of `informational` and above to the syslog server with IP address `10.32.16.21` use the following commands:

```
awplus# configure terminal
awplus(config)# log host 10.32.16.21 level informational
```

To remove a filter that sends all messages generated by BGP that have a severity of `notices` or higher to a remote syslog server with IP address `10.32.16.21` use the following commands:

```
awplus# configure terminal
awplus(config)# no log host 10.32.16.21 level notices program
bgp
```

To remove a filter that sends all messages containing the text `"Bridging initialization"`, to a remote syslog server with IP address `10.32.16.21` use the following commands:

```
awplus# configure terminal
awplus(config)# no log host 10.32.16.21 msgtext "Bridging
initialization"
```

To remove a filter that sends messages with a severity level of `informational` and above to the syslog server with IP address `10.32.16.21` use the following commands:

```
awplusawplus# configure terminal
awplus(config)# no log host 10.32.16.21 level informational
```

Related Commands [default log host](#)
[show log config](#)

log host time

This command configures the time used in messages sent to a remote syslog server. If the syslog server is in a different time zone to your switch then the time offset can be configured using either the **utc-offset** parameter option keyword or the **local-offset** parameter option keyword, where **utc-offset** is the time difference from UTC (Universal Time, Coordinated) and **local-offset** is the difference from local time.

Syntax `log host <email-address> time {local|local-offset|utc-offset
{plus|minus} <0-24>}`

Parameter	Description
<email-address>	The email address to send log messages to
time	Specify the time difference between the email recipient and the switch you are configuring.
local	The switch is in the same time zone as the email recipient
local-offset	The switch is in a different time zone to the email recipient. Use the plus or minus keywords and specify the difference (offset) from local time of the switch to the email recipient in hours.
utc-offset	The switch is in a different time zone to the email recipient. Use the plus or minus keywords and specify the difference (offset) from UTC time of the switch to the email recipient in hours.
plus	Negative offset (difference) from the switch to the syslog server.
minus	Positive offset (difference) from the switch to the syslog server.
<0-24>	World Time zone offset in hours

Default The default is **local** time.

Mode Global Configuration

Usage Use the **local** option if the remote syslog server is in the same time zone as the switch. Messages will display the time as on the local device when the message was generated.

Use the **offset** option if the email recipient is in a different time zone to this device. Specify the time offset of the remote syslog server in hours. Messages will display the time they were generated on this device but converted to the time zone of the remote syslog server.

Examples To send messages to the remote syslog server with the IP address 10.32.16.21 in the same time zone as the switch's local time zone, use the following commands:

```
awplus# configure terminal
awplus(config)# log host 10.32.16.21 time local 0
```

To send messages to the remote syslog server with the IP address 10.32.16.12 with the time information converted to the time zone of the remote syslog server, which is 3 hours ahead of the switch's local time zone, use the following commands:

```
awplus# configure terminal
awplus(config)# log host 10.32.16.12 time local-offset plus 3
```

To send messages to the remote syslog server with the IP address 10.32.16.02 with the time information converted to the time zone of the email recipient, which is 3 hours behind the switch's UTC time zone, use the following commands:

```
awplus# configure terminal
awplus(config)# log host 10.32.16.02 time utc-offset minus 3
```

**Validation
Commands** `show log config`

Related Commands `default log buffered`

log monitor (filter)

This command creates a filter to select messages to be sent to the terminal when the terminal monitor command is given. Selection can be based on the priority/severity of the message, the program that generated the message, the logging facility used, a sub-string within the message or a combination of some or all of these.

Syntax `log monitor [level <level>] [program <program-name>]
 [facility <facility>] [msgtext <text-string>]`

`no log monitor [level <level>] [program <program-name>]
 [facility <facility>] [msgtext <text-string>]`

Parameter	Description																
level	Filter messages to the permanent log by severity level.																
<level>	The minimum severity of message to send to the log. The level can be specified as one of the following numbers or level names, where 0 is the highest severity and 7 is the lowest severity: <table border="0" data-bbox="667 869 1257 1182"> <tr> <td>0 emergencies:</td> <td>System is unusable</td> </tr> <tr> <td>1 alerts</td> <td>Action must be taken immediately</td> </tr> <tr> <td>2 critical</td> <td>Critical conditions</td> </tr> <tr> <td>3 errors</td> <td>Error conditions</td> </tr> <tr> <td>4 warnings</td> <td>Warning conditions</td> </tr> <tr> <td>5 notices</td> <td>Normal, but significant, conditions</td> </tr> <tr> <td>6 informational</td> <td>Informational messages</td> </tr> <tr> <td>7 debugging</td> <td>Debug-level messages</td> </tr> </table>	0 emergencies:	System is unusable	1 alerts	Action must be taken immediately	2 critical	Critical conditions	3 errors	Error conditions	4 warnings	Warning conditions	5 notices	Normal, but significant, conditions	6 informational	Informational messages	7 debugging	Debug-level messages
0 emergencies:	System is unusable																
1 alerts	Action must be taken immediately																
2 critical	Critical conditions																
3 errors	Error conditions																
4 warnings	Warning conditions																
5 notices	Normal, but significant, conditions																
6 informational	Informational messages																
7 debugging	Debug-level messages																
program	Filter messages to the permanent log by program. Include messages from a specified program in the log.																

Parameter (cont.)	Description (cont.)
<i><program-name></i>	The name of a program to log messages from, either one of the following predefined program names (not case-sensitive), or another program name (case -sensitive) that you find in the log output.
rip	Routing Information Protocol (RIP)
ripng	Routing Information Protocol - next generation (RIPng)
ospf	Open Shortest Path First (OSPF)
ospfv3	Open Shortest Path First (OSPF) version 3 (OSPFv3)
bgp	Border Gateway Protocol (BGP)
rsvp	Resource Reservation Protocol (RSVP)
pim-dm	Protocol Independent Multicast - Dense Mode (PIM-DM)
pim-sm	Protocol Independent Multicast - Sparse Mode (PIM-SM)
pim-smv6	Protocol Independent Multicast - Spare Mode version 6 (PIM-SMv6)
dot1x	IEEE 802.1X Port-Based Access Control
lACP	Link Aggregation Control Protocol (LACP)
stp	Spanning Tree Protocol (STP)
rstp	Rapid Spanning Tree Protocol (RSTP)
mstp	Multiple Spanning Tree Protocol (MSTP)
imi	Integrated Management Interface (IMI)
imish	Integrated Management Interface Shell (IMISH)
epsr	Ethernet Protection Switched Rings (EPSR)
irdp	ICMP Router Discovery Protocol (IRDP)
rmon	Remote Monitoring
loopprot	Loop Protection
poe	Power-inline (Power over Ethernet)
dhcpcsn	DHCP snooping (DHCP SN)
<i>facility</i>	Filter messages to the permanent log by syslog facility.
<i><facility></i>	Specify one of the following syslog facilities to include messages from in the log:
kern	Kernel messages
user	Random user-level messages
mail	Mail system
daemon	System daemons
auth	Security/authorization messages
syslog	Messages generated internally by syslogd
lpr	Line printer subsystem
news	Network news subsystem
uucp	UUCP subsystem
cron	Clock daemon
authpriv	Security/authorization messages (private)
ftp	FTP daemon

Parameter (cont.)	Description (cont.)
msgtext	Select messages containing a certain text string
<text-string>	A text string to match. This is case sensitive, and must be the last text on the command line.

Default By default there is a filter to select all messages. This filter may be removed and replaced by filters that are more selective.

Mode Global Configuration

Examples To create a filter to send all messages generated by MSTP that have a severity of `info` or higher to terminal instances where the terminal monitor command has been given use the following commands:

```
awplus# configure terminal
awplus(config)# log monitor level info program mstp
```

To remove a filter that sends all messages generated by BGP that have a severity of `notices` or higher to the terminal use the following commands:

```
awplus# configure terminal
awplus(config)# no log monitor level notices program bgp
```

To remove a default filter that includes sending everything to the terminal use the following commands:

```
awplus# configure terminal
awplus(config)# no log monitor level debugging
```

Validation Commands `show log config`

Related Commands `terminal monitor`

log permanent

This command configures the device to send log messages to non-volatile storage (NVS) on the device. Log messages sent to NVS are retained on the device over a restart, that is they are permanent. Once the permanent log reaches its configured maximum allowable size old messages will be deleted to make way for new ones.

The **no** variant of this command configures the device not to send any messages to the permanent log. Log messages will not be retained over a restart.

Syntax `log permanent`
`no log permanent`

Mode Global Configuration

Examples To enable permanent logging use the following commands:

```
awplus# configure terminal
awplus(config)# log permanent
```

To disable permanent logging use the following commands:

```
awplus# configure terminal
awplus(config)# no log permanent
```

**Validation
Commands** `show log config`

Related Commands `default log permanent`
`log permanent (filter)`
`log permanent size`
`show log permanent`

log permanent (filter)

This command creates a filter to select messages to be sent to the permanent log. Selection can be based on the priority/ severity of the message, the program that generated the message, the logging facility used, a sub-string within the message or a combination of some or all of these.

The **no** variant of this command removes the corresponding filter, so that the specified messages are no longer sent to the permanent log.

Syntax

```
log permanent [level <level>] [program <program-name>]
               [facility <facility>] [msgtext <text-string>]

no log permanent [level <level>] [program <program-name>]
                 [facility <facility>] [msgtext <text-string>]
```

Parameter	Description																
level	Filter messages to the permanent log by severity level.																
<level>	<p>The minimum severity of message to send to the log. The level can be specified as one of the following numbers or level names, where 0 is the highest severity and 7 is the lowest severity:</p> <table> <tbody> <tr> <td>0 emergencies:</td> <td>System is unusable</td> </tr> <tr> <td>1 alerts</td> <td>Action must be taken immediately</td> </tr> <tr> <td>2 critical</td> <td>Critical conditions</td> </tr> <tr> <td>3 errors</td> <td>Error conditions</td> </tr> <tr> <td>4 warnings</td> <td>Warning conditions</td> </tr> <tr> <td>5 notices</td> <td>Normal, but significant, conditions</td> </tr> <tr> <td>6 informational</td> <td>Informational messages</td> </tr> <tr> <td>7 debugging</td> <td>Debug-level messages</td> </tr> </tbody> </table>	0 emergencies:	System is unusable	1 alerts	Action must be taken immediately	2 critical	Critical conditions	3 errors	Error conditions	4 warnings	Warning conditions	5 notices	Normal, but significant, conditions	6 informational	Informational messages	7 debugging	Debug-level messages
0 emergencies:	System is unusable																
1 alerts	Action must be taken immediately																
2 critical	Critical conditions																
3 errors	Error conditions																
4 warnings	Warning conditions																
5 notices	Normal, but significant, conditions																
6 informational	Informational messages																
7 debugging	Debug-level messages																

Parameter (cont.)	Description (cont.)
<code>program</code>	Filter messages to the permanent log by program. Include messages from a specified program in the log.
<code><program-name></code>	The name of a program to log messages from, either one of the following predefined program names (not case-sensitive), or another program name (case -sensitive) that you find in the log output.
<code>rip</code>	Routing Information Protocol (RIP)
<code>ripng</code>	Routing Information Protocol - next generation (RIPng)
<code>ospf</code>	Open Shortest Path First (OSPF)
<code>ospfv3</code>	Open Shortest Path First (OSPF) version 3 (OSPFv3)
<code>bgp</code>	Border Gateway Protocol (BGP)
<code>rsvp</code>	Resource Reservation Protocol (RSVP)
<code>pim-dm</code>	Protocol Independent Multicast - Dense Mode (PIM-DM)
<code>pim-sm</code>	Protocol Independent Multicast - Sparse Mode (PIM-SM)
<code>pim-smv6</code>	Protocol Independent Multicast - Spare Mode version 6 (PIM-SMv6)
<code>dot1x</code>	IEEE 802.1X Port-Based Access Control
<code>lacp</code>	Link Aggregation Control Protocol (LACP)
<code>stp</code>	Spanning Tree Protocol (STP)
<code>rstp</code>	Rapid Spanning Tree Protocol (RSTP)
<code>mstp</code>	Multiple Spanning Tree Protocol (MSTP)
<code>imi</code>	Integrated Management Interface (IMI)
<code>imish</code>	Integrated Management Interface Shell (IMISH)
<code>epsr</code>	Ethernet Protection Switched Rings (EPSR)
<code>irdp</code>	ICMP Router Discovery Protocol (IRDP)
<code>rmon</code>	Remote Monitoring
<code>loopprot</code>	Loop Protection
<code>poe</code>	Power-inline (Power over Ethernet)
<code>dhcpsn</code>	DHCP snooping (DHCP SN)
<code>facility</code>	Filter messages to the permanent log by syslog facility.
<code><facility></code>	Specify one of the following syslog facilities to include messages from in the log:
<code>kern</code>	Kernel messages
<code>user</code>	Random user-level messages
<code>mail</code>	Mail system
<code>daemon</code>	System daemons
<code>auth</code>	Security/authorization messages
<code>syslog</code>	Messages generated internally by syslogd
<code>lpr</code>	Line printer subsystem
<code>news</code>	Network news subsystem
<code>uucp</code>	UUCP subsystem
<code>cron</code>	Clock daemon
<code>authpriv</code>	Security/authorization messages (private)
<code>ftp</code>	FTP daemon

Parameter (cont.)	Description (cont.)
msgtext	Select messages containing a certain text string
<i><text-string></i>	A text string to match. This is case sensitive, and must be the last text on the command line.

Default By default the buffered log has a filter to select messages whose severity level is `notices` (5) or higher. This filter may be removed using the `no` variant of this command.

Mode Global Configuration

Examples To create a filter to send all messages generated by BGP that have a severity of `notices` or higher to the permanent log use the following commands:

```
awplus# configure terminal
```

```
awplus(config)# log permanent level notices program bgp
```

To create a filter to send all messages containing the text "Bridging initialization", to the permanent log use the following commands:

```
awplus# configure terminal
```

```
awplus(config)# log permanent msgtext Bridging initialization
```

Validation Commands `show log config`

Related Commands `default log permanent`
`log permanent`
`log permanent size`
`show log permanent`

log permanent size

This command configures the amount of memory that the permanent log is permitted to use. Once this memory allocation has been filled old messages will be deleted to make room for new messages.

Syntax `log permanent size <50-250>`

Parameter	Description
<50-250>	Size of the permanent log in kilobytes

Mode Global Configuration

Example To allow the permanent log to use up to 100 kB of NVS use the following commands:

```
awplus# configure terminal
awplus(config)# log permanent size 100
```

**Validation
Commands** `show log config`

Related Commands `default log permanent`
`log permanent`

log-rate-limit nsm

This command limits the number of log messages generated by the switch for a given interval.

Use the **no** variant of this command to revert to the default number of log messages generated by the switch of up to 200 log messages per second.

Syntax `log-rate-limit nsm messages <message-limit> interval <time-interval>`
`no log-rate-limit nsm`

Parameter	Description
<code><message-limit></code>	<code><1-65535></code> The number of log messages generated by the switch.
<code><time-interval></code>	<code><0-65535></code> The time period for log message generation in 1/100 seconds. If an interval of 0 is specified then no log message rate limiting is applied.

Default By default, the switch will allow 200 log messages to be generated per second.

Mode Global Configuration

Usage Previously, if the switch received a continuous stream of IGMP packets with errors, such as when a packet storm occurs because of a network loop, then the switch generates a lot of log messages using more and more memory, which may ultimately cause the switch to shutdown. This log rate limiting feature constrains the rate that log messages are generated by the switch.

Note that if within the given time interval, the number of log messages exceeds the limit, then any excess log messages are discarded. At the end of the time interval, a single log message is generated indicating that log messages were discarded due to the log rate limit being exceeded.

Thus if the expectation is that there will be a lot of discarded log messages due to log rate limiting, then it is advisable to set the time interval to no less than 100, which means that there would only be one log message, indicating log excessive log messages have been discarded.

Examples To limit the switch to generate up to 300 log messages per second, use the following commands:

```
awplus# configure terminal
awplus(config)# log-rate-limit nsm messages 300 interval 100
```

To return the switch the default setting, to generate up to 200 log messages per second ,use the following commands:

```
awplus# configure terminal
awplus(config)# no log-rate-limit nsm
```

show counter log

This command displays log counter information.

For information on output options, see [“Controlling “show” Command Output” on page 1.35](#).

Syntax show counter log

Mode Privileged Exec

Example To display the log counter information, use the command:

```
awplus# show counter log
```

Output Figure 10-1: Example output from the **show counter log** command

```
Log counters
Total Received          ..... 2328
Total Received P0      ..... 0
Total Received P1      ..... 0
Total Received P2      ..... 1
Total Received P3      ..... 9
Total Received P4      ..... 32
Total Received P5      ..... 312
Total Received P6      ..... 1602
Total Received P7      ..... 372
```

Table 10-1: Parameters in output of the **show counter log** command

Parameter	Description
Total Received	Total number of messages received by the log
Total Received P0	Total number of Priority 0 (Emergency) messages received
Total Received P1	Total number of Priority 1 (Alert) messages received
Total Received P2	Total number of Priority 2 (Critical) messages received
Total Received P3	Total number of Priority 3 (Error) messages received
Total Received P4	Total number of Priority 4 (Warning) messages received
Total Received P5	Total number of Priority 5 (Notice) messages received
Total Received P6	Total number of Priority 6 (Info) messages received
Total Received P7	Total number of Priority 7 (Debug) messages received

Related Commands [show log config](#)

show exception log

This command displays the contents of the exception log. When used within a virtual chassis stack (VCS), this command will display the contents of the exception log for all the stack members.

Syntax `show exception log`

Mode Privileged Exec

Example To display the exception log, use the command:

```
awplus# show exception log
```

Output Figure 10-2: Example output from the `show exception log` command

```
Stack member 1:
<date> <time> <facility>.<severity> <program[<pid>]>: <message>
-----
2008 May 29 04:08:46 local7.debug awplus corehandler: Process imish (PID:2200) s
ignal 5, core dumped to /flash/imish-r1-main-xinz-1212034124-2200.tgz
2008 May 29 04:10:21 local7.debug awplus corehandler: Process stackd (PID:1136)
signal 5, core dumped to /flash/stackd-r1-main-xinz-1212034216-1136.tgz
-----
Stack member 2:
<date> <time> <facility>.<severity> <program[<pid>]>: <message>
-----
2008 Mar 28 03:15:32 local7.debug awplus corehandler: Process imish (PID:2253) s
ignal 5, core dumped to /flash/imish-r1-main-xinz-7442130-2253.tgz
2008 Mar 28 03:16:06 local7.debug awplus corehandler: Process imish (PID:2416) s
ignal 5, core dumped to /flash/imish-r1-main-xinz-7442165-2416.tgz
2008 Mar 28 03:17:33 local7.debug awplus corehandler: Process aisexec (PID:1786)
  signal 5, core dumped to /flash/aisexec-r1-main-xinz-7442251-1786.tgz
-----
```

show log

This command displays the contents of the buffered log.

For information on output options, see “Controlling “show” Command Output” on page 1.35.

Syntax `show log [tail [<10-250>]]`

Parameter	Description
<code>tail</code>	Display only the latest log entries
<code><10-250></code>	Specify the number of log entries to display

Default By default the entire contents of the buffered log is displayed.

Mode Privileged Exec and Global Configuration

Usage If the optional **tail** parameter is specified only the latest 10 messages in the buffered log are displayed. A numerical value can be specified after the **tail** parameter to select how many of the latest messages should be displayed.

Examples To display the contents of the buffered log use the command:

```
awplus# show log
```

To display the 10 latest entries in the buffered log use the command:

```
awplus# show log tail 10
```

Output Figure 10-3: Example output from the **show log** command

```
<date> <time> <facility>.<severity> <program[<pid>]>: <message>
-----
2006 Nov 10 09:30:09 syslog.notice syslog-ng[67]: syslog-ng starting up;
version='\2.0rc3\'
2006 Nov 10 09:30:09 auth.warning portmap[106]: user rpc not found, reverting to
user bin
2006 Nov 10 09:30:09 cron.notice crond[116]: crond 2.3.2 dillon, started, log level
8
2006 Nov 10 09:30:14 daemon.err snmpd[181]: /flash/.configs/snmpd.conf: line 20:
Error: bad SUBTREE object 2006 Nov 10 09:30:14 user.info HSL[192]: HSL: INFO:
Registering port port1.0.1
...
```

Figure 10-4: Example output from the `show log tail` command

```
<date> <time> <facility>.<severity> <program[<pid>]>: <message>
-----
2006 Nov 10 13:30:01 cron.notice crond[116]: USER manager pid 469 cmd logrotate /
etc/logrotate.conf
2006 Nov 10 13:30:01 cron.notice crond[116]: USER manager pid 471 cmd nbqueue --
wipe
2006 Nov 10 13:35:01 cron.notice crond[116]: USER manager pid 472 cmd nbqueue --
wipe
2006 Nov 10 13:40:01 cron.notice crond[116]: USER manager pid 477 cmd nbqueue --
wipe
2006 Nov 10 13:44:36 syslog.notice syslog-ng[67]: Log statistics;
processed='center(queued)=70\' , processed='2006 Nov 10 13:45:01 cron.notice
crond[116]: USER manager pid 478 cmd logrotate /etc/logrotate.conf
2006 Nov 10 13:45:01 cron.notice crond[116]: USER manager pid 480 cmd nbqueue --
wipe
2006 Nov 10 13:49:32 syslog.notice syslog-ng[67]: SIGHUP received, reloading
configuration;
2006 Nov 10 13:50:01 cron.notice crond[116]: USER manager pid 482 cmd nbqueue --
wipe
2006 Nov 10 13:55:01 cron.notice crond[116]: USER manager pid 483 cmd nbqueue --
wipe
...
```

Related Commands `show log config`
 `show log permanent`

show log config

This command displays information about the logging system. This includes the configuration of the various log destinations, buffered, permanent, syslog servers (hosts) and email addresses. This also displays the latest status information for each of these destinations.

Syntax `show log config`

Mode Privileged Exec and Global Configuration

Example To display the logging configuration use the command:

```
awplus# show log config
```

Output Figure 10-5: Example output from the `show log config` command

```
Buffered log:
Status ..... enabled
Maximum size ... 100kb
Filters:
*1 Level ..... notices
  Program ..... any
  Facility ..... any
  Message text . any
  2 Level ..... informational
    Program ..... mstp
    Facility ..... daemon
    Message text . any
  Statistics ..... 1327 messages received, 821 accepted by filter (2006 Dec 11
10:36:16)
Permanent log:
Status ..... enabled
Maximum size ... 60kb
Filters:
  1 Level ..... error
    Program ..... any
    Facility ..... any
    Message text . any
  *2 Level ..... warnings
    Program ..... dhcp
    Facility ..... any
    Message text . "pool exhausted"
  Statistics ..... 1327 messages received, 12 accepted by filter (2006 Dec 11
10:36:16)
Host 10.32.16.21:
Time offset .... +2:00
Offset type .... UTC
Filters:
  1 Level ..... critical
    Program ..... any
    Facility ..... any
    Message text . any
  Statistics ..... 1327 messages received, 1 accepted by filter (2006 Dec 11
10:36:16)
Email admin@alliedtelesis.com:
Time offset .... +0:00
Offset type .... Local
Filters:
  1 Level ..... emergencies
    Program ..... any
    Facility ..... any
    Message text . any
  Statistics ..... 1327 messages received, 0 accepted by filter (2006 Dec 11
10:36:16)
Monitor log:
Filters:
*1 Level ..... debugging
  Program .... any
  Facility ... any
  Msg text ... any
  Statistics ..... Not available
Console log:
Status ..... enabled
List of consoles:
  1 ..... ttyS0
Filters:
*1 Level ..... critical
  Program .... any
  Facility ... any
  Msg text ... any
  Statistics ..... 1327 messages received, 1 accepted by filter (2006 Dec 11
10:36:16)
```

In the above example the '*' next to filter 1 in the buffered log configuration indicates that this is the default filter. The permanent log has had its default filter removed, so none of the filters are marked with '*'.

Note  Statistics are updated periodically not in real time. Whenever logging configuration commands are issued the statistics are reset. Whenever automatic log rotation occurs the statistics are reset

Note  Terminal log and console log cannot be set at the same time. If console logging is enabled then the terminal logging is turned off.

Related Commands [show counter log](#)
[show log](#)
[show log permanent](#)

show log permanent

This command displays the contents of the permanent log. This command displays the contents of the permanent log. When used within a virtual chassis stack (VCS), this command will display the contents of the permanent log for all the stack members.

Syntax `show log permanent [tail [<10-250>]]`

Parameter	Description
<code>tail</code>	Display only the latest log entries
<code><10-250></code>	Specify the number of log entries to display

Default If the optional **tail** parameter is specified only the latest 10 messages in the permanent log are displayed. A numerical value can be specified after the **tail** parameter to select how many of the latest messages should be displayed.

Mode Privileged Exec and Global Configuration

Example To display the permanent log, use the command:

```
awplus# show log permanent
```

Output Figure 10-6: Example output from the `show log permanent` command

```

<date> <time> <facility>.<severity> <program[<pid>]>: <message>
-----
2006 Nov 10 09:30:09 syslog.notice syslog-ng[67]: syslog-ng starting up;
version='2.0rc3\'
2006 Nov 10 09:30:09 auth.warning portmap[106]: user rpc not found, reverting to
user bin
2006 Nov 10 09:30:09 cron.notice crond[116]: crond 2.3.2 dillon, started, log level
8
2006 Nov 10 09:30:14 daemon.err snmpd[181]: /flash/.configs/snmpd.conf: line 20:
Error: bad SUBTREE object 2006 Nov 10 09:30:14 user.info HSL[192]: HSL: INFO:
Registering port port1.0.1
...
To display the 10 latest entries in the permanent log use the command:
awplus>show log permanent tail
<date> <time> <facility>.<severity> <program[<pid>]>: <message>
-----
2006 Nov 10 13:30:01 cron.notice crond[116]: USER manager pid 469 cmd logrotate /
etc/logrotate.conf
2006 Nov 10 13:30:01 cron.notice crond[116]: USER manager pid 471 cmd nbqueue --
wipe
2006 Nov 10 13:35:01 cron.notice crond[116]: USER manager pid 472 cmd nbqueue --
wipe
2006 Nov 10 13:40:01 cron.notice crond[116]: USER manager pid 477 cmd nbqueue --
wipe
2006 Nov 10 13:44:36 syslog.notice syslog-ng[67]: Log statistics;
processed='center(queued)=70\'', processed='2006 Nov 10 13:45:01 cron.notice
crond[116]: USER manager pid 478 cmd logrotate /etc/logrotate.conf
2006 Nov 10 13:45:01 cron.notice crond[116]: USER manager pid 480 cmd nbqueue --
wipe
2006 Nov 10 13:49:32 syslog.notice syslog-ng[67]: SIGHUP received, reloading
configuration;
2006 Nov 10 13:50:01 cron.notice crond[116]: USER manager pid 482 cmd nbqueue --
wipe
2006 Nov 10 13:55:01 cron.notice crond[116]: USER manager pid 483 cmd nbqueue --
wipe
-----
...

```

Figure 10-7: Example output from the `show log permanent` command for a stack

```

Stack member 1:

<date> <time> <facility>.<severity> <program[<pid>]>: <message>
-----
2008 May 28 23:11:21 user.crit awplus-2 VCS[1190]: Member 2 (00-00-cd-24-ff-57)
has become the Active Master
2008 May 28 23:11:21 daemon.warning awplus-2 rpc.statd[1300]: gethostbyname erro
r for awplus-2
2008 May 28 23:11:21 daemon.warning awplus-2 rpc.statd[1304]: gethostbyname erro
r for awplus-2
2008 May 28 23:11:53 user.err awplus NSM[1950]: VRRP Error: Can't set pktinfo
2008 May 29 03:54:40 user.alert awplus corerotate[26733]: Exception information
saved to flash:/imish-r1-main-xinz-7441248-19868.tgz
2008 May 29 03:55:47 user.crit awplus-1 VCS[1143]: Contact with the Active Maste
r has been lost
2008 May 29 03:55:47 user.crit awplus-1 VCS[1143]: Member 1 (00-09-41-fb-c3-0f)
has become the Disabled Master
2008 May 29 03:55:47 daemon.err awplus-1 mountd[1282]: Caught signal 15, un-regi
stering and exiting.
2008 May 29 03:55:47 user.warning awplus-1 kernel: nfsd: last server has exited
2008 May 29 03:55:47 user.warning awplus-1 kernel: nfsd: unexporting all filesys
tems

Stack member 2:

<date> <time> <facility>.<severity> <program[<pid>]>: <message>
-----
1970 Mar 27 22:17:33 user.crit awplus-1 VCS[1143]: Member 2 (00-00-cd-24-ff-57)
has become the Active Master
1970 Mar 27 22:17:33 user.alert awplus-1 VCS[1143]: Slave Boot from non-default
location, SW version auto synchronization does not support.
1970 Mar 27 22:17:38 daemon.warning awplus-1 rpc.statd[1271]: gethostbyname erro
r for awplus-1
1970 Mar 27 22:17:38 daemon.warning awplus-1 rpc.statd[1276]: gethostbyname erro
r for awplus-1
1970 Mar 28 03:00:52 user.alert awplus corerotate[26733]: Exception information
saved to flash:/imish-r1-main-xinz-7441248-19868.tgz
1970 Mar 28 03:01:59 user.warning awplus NSM[1950]: imi_client_send_xem_removal
port1.0.1
1970 Mar 28 03:01:59 user.warning awplus NSM[1950]: imi_client_send_xem_removal
port1.2.1
1970 Mar 28 03:15:34 user.alert awplus corerotate[2380]: Exception information s
aved to flash:/imish-r1-main-xinz-7442130-2253.tgz
1970 Mar 28 03:16:08 user.alert awplus corerotate[2495]: Exception information s
aved to flash:/imish-r1-main-xinz-7442165-2416.tgz
1970 Mar 28 03:17:31 user.err awplus VCS[1200]: HA event handling failed with re
sult 9
1970 Mar 28 03:17:31 user.err awplus HSL[1246]: connection to aisexec lost (9)
1970 Mar 28 03:17:31 user.err awplus 802.1X[1451]: connection to aisexec lost (9)

```

Related Commands [remote-command](#)
 [show log](#)

show running-config log

This command displays the current running configuration of the Log utility.

Syntax `show running-config log`

Mode Privileged Exec

Example To display the current configuration of the log utility, use the command:

```
awplus# show running-config log
```

Related Commands [show log](#)
[show log config](#)

Chapter 11: Scripting Commands



Command List	11.2
activate	11.2
echo	11.3
wait	11.4

Command List

This chapter provides commands used for command scripts.

activate

This command activates a script file.

Syntax `activate [background] <script>`

Parameter	Description
<code>background</code>	Activate a script to run in the background. A process that is running in the background will operate as a separate task, and will not interrupt foreground processing. Generally, we recommend running short, interactive scripts in the foreground and longer scripts in the background. The default is to run the script in the foreground.
<code><script></code>	The file name of the script to activate. The script is a command script consisting of commands documented in this software reference. Note that you must use either a <code>.scp</code> or a <code>.sh</code> filename extension for a valid script text file, as described below in the usage section for this command.

Mode Privileged Exec

Usage In a stacked environment you can use the CLI on a stack master to access file systems that are located on a slave device. In this case the command specifies a file on the slave device. The slave's file system will be denoted by: `<hostname>-<member-id>` For example, `awplus-1` for member 1, `awplus-2` for member 2 etc.

When a script is activated, the privilege level is set to 1 enabling User Exec commands to run in the script. If you need to run Privileged Exec commands in your script you need to add an [enable \(Privileged Exec mode\)](#) command to the start of your script. If you need to run Global Configuration commands in your script you need to add a [configure terminal](#) command after the `enable` command at the start of your script.

The `activate` command executes the script in a new shell. A [terminal length](#) shell command, such as `terminal length 0` may also be required to disable a delay that would pause the display.

A script must be a text file with a filename extension of either `.sh` or `.scp` only for the AlliedWare Plus™ CLI to activate the script file. The `.sh` filename extension indicates the file is an ASH script, and the `.scp` filename extension indicates the file is an AlliedWare Plus™ script.

Examples To activate a command script to run as a background process, use the command:

```
awplus# activate background test.scp
```

To activate a script `/flash:/test.scp` in stack member 2, use the command:

```
awplus-2# activate awplus-2/flash:/test.scp
```

Related Commands [configure terminal](#)
[echo](#)
[enable \(Privileged Exec mode\)](#)
[wait](#)

echo

This command echoes a string to the terminal, followed by a blank line.

Syntax `echo <line>`

Parameter	Description
<code><line></code>	The string to echo

Mode User Exec and Privileged Exec

Usage This command may be useful in CLI scripts, to make the script print user-visible comments.

Example To echo the string `Hello World` to the console, use the command:

```
awplus# echo Hello World
```

Hello World

Related Commands `activate`
`wait`

wait

This command pauses execution of the active script for the specified period of time.

Syntax `wait <delay>`

Parameter	Description
<code><delay></code>	<code><1-65335></code> Specify the time delay in seconds

Default No wait delay is specified by default to pause script execution.

Mode Privileged Exec (when executed from a script not directly from the command line)

Usage Use this command to pause script execution in an `.scp` (AlliedWare Plus™ script) or an `.sh` (ASH script) file executed by the `activate` command. The script must contain an `enable (Privileged Exec mode)` command since the `wait` command is only executed in the Privileged Exec mode. When a script is activated, the privilege level is set to 1 enabling User Exec commands to run in the script. If you need to run Privileged Exec commands in your script you need to add an `enable (Privileged Exec mode)` command to the start of your script.

Example See an example `.scp` script file extract below that will show port counters for interface `port1.0.1` over a 10 second interval:

```
enable
show interface port1.0.1
wait 10
show interface port1.0.1
```

Related Commands `activate`
`echo`
`enable (Privileged Exec mode)`

Chapter 12: Interface Commands



Command List	12.2
description (interface)	12.2
interface (to configure)	12.3
mtu	12.4
show interface	12.6
show interface brief	12.9
show interface status	12.10
shutdown	12.12

Command List

This chapter provides an alphabetical reference of commands used to configure and display interfaces.

description (interface)

Use this command to add a description to a specific port or interface.

Syntax `description <description>`

Parameter	Description
<code><description></code>	Text describing the specific interface.

Mode Interface Configuration

Example The following example uses this command to describe the device that a switch port is connected to.

```
awplus# configure terminal
awplus(config)# interface port1.0.2
awplus(config-if)# description Boardroom PC
```

interface (to configure)

Use this command to select one or more interfaces to configure.

Syntax `interface <interface-list>`

`interface lo`

Parameter	Description
<code><interface-list></code>	<p>The interfaces or ports to configure. An interface-list can be:</p> <ul style="list-style-type: none"> ■ an interface (e.g. <code>vlan2</code>), a switch port (e.g. <code>port1.1.12</code>), a static channel group (e.g. <code>sa3</code>) or a dynamic (LACP) channel group (e.g. <code>po4</code>) ■ a continuous range of interfaces, ports, static channel groups or dynamic (LACP) channel groups separated by a hyphen; e.g. <code>vlan2-8</code>, or <code>port1.1.1-1.1.24</code>, or <code>sa2-4</code>, or <code>po1-3</code> ■ a comma-separated list of the above; e.g. <code>port1.0.1,port1.1.1-1.2.24</code>. Do not mix interface types in a list. <p>The specified interfaces must exist.</p>
<code>lo</code>	The local interface ¹ .

1. A local interface is one that is always available for higher layer protocols to use and advertise to the network. Although a local interface is assigned an IP address, it does not have the usual requirement of connecting to a lower layer physical entity. This lack of physical attachment creates the perception of a local interface always being accessible via the network.

Local interfaces can be utilized by a number of protocols for various purposes. They can be used to improve access to the switch and also increase its reliability, security, scalability and protection. In addition, local interfaces can add flexibility and simplify management, information gathering and filtering.

One example of this increased reliability is for OSPF to advertise a local interface as an interface-route into the network irrespective of the physical links that may be "up" or "down" at the time. This provides a higher probability that the routing traffic will be received and subsequently forwarded.

Mode Global Configuration

Example The following example shows how to enter Interface mode to configure `vlan1`. Note how the prompt changes.

```
awplus# configure terminal
awplus(config)# interface vlan1
awplus(config-if)#
```

Related Commands [show interface](#)
[show interface brief](#)

mtu

Use this command to set the Maximum Transmission Unit (MTU) size for VLANs, where MTU is the maximum packet size that VLANs can transmit. The MTU size setting is applied to both IPv4 and IPv6 packet transmission.

Use the **no** variant of this command to remove a previously specified Maximum Transmission Unit (MTU) size for VLANs, and restore the default MTU size (1500 bytes) for VLANs.

Syntax `mtu <mtu-size>`

`no mtu`

Parameter	Description
<code><mtu-size></code>	<68-1500> Specifies the Maximum Transmission Unit (MTU) size in bytes, where: <ul style="list-style-type: none"> ■ 1500 bytes is the default Ethernet MTU size for an interface.

Default The default MTU size is 1500 bytes for VLAN interfaces.

Mode Interface Configuration for VLAN interfaces.

Usage If a switch receives an IPv4 packet for layer 3 switching to another VLAN with an MTU size smaller than the packet size, and if the packet has the **'don't fragment'** bit set, then the switch will send an ICMP **'destination unreachable'** (3) packet type and a **'fragmentation needed and DF set'** (4) code back to the source. For IPv6 packets bigger than the MTU size of the transmitting VLAN interface, an ICMP **'packet too big'** (ICMP type 2 code 0) message is sent to the source.

Note that `show interface` output will only show MTU size for VLAN interfaces.

Examples To configure an MTU size of 1500 bytes on interface `vlan2`, use the commands:

```
awplus# configure terminal
awplus(config)# interface vlan2
awplus(config-if)# mtu 1500
```

To configure an MTU size of 1500 bytes on interfaces `vlan2` to `vlan4`, use the commands:

```
awplus# configure terminal
awplus(config)# interface vlan2-vlan4
awplus(config-if)# mtu 1500
```

To restore the MTU size to the default MTU size of 1500 bytes on `vlan2`, use the commands

```
awplus# configure terminal
awplus(config)# interface vlan2
awplus(config-if)# no mtu
```

To restore the MTU size to the default MTU size of 1500 bytes on `vlan2` and `vlan4`, use the commands

```
awplus# configure terminal
awplus(config)# interface vlan2-vlan4
awplus(config-if)# no mtu
```

Related Commands [show interface](#)

show interface

Use this command to display interface configuration and status.

For information on output options, see [“Controlling “show” Command Output”](#) on page 1.35.

Syntax `show interface [<interface-list>]`

Parameter	Description
<interface-list>	<p>The interfaces to display information about. An interface list can be:</p> <ul style="list-style-type: none"> ■ an interface (e.g. <code>vlan2</code>), a switch port (e.g. <code>port1.1.12</code>), a static channel group (e.g. <code>sa3</code>) or a dynamic (LACP) channel group (e.g. <code>po4</code>) ■ a continuous range of interfaces, ports, static channel groups or dynamic (LACP) channel groups separated by a hyphen; e.g. <code>vlan2-8</code>, or <code>port1.1.1-1.1.24</code>, or <code>sa2-4</code>, or <code>po1-3</code> ■ a comma-separated list of the above; e.g. <code>port1.0.1, port1.1.1-1.2.24</code>. Do not mix interface types in a list. <p>The specified interfaces must exist.</p>

Mode User Exec and Privileged Exec

Usage Note that the output displayed with this command will show MTU (Maximum Transmission Unit) size for VLAN interfaces, and MRU (Maximum Received Unit) size for switch ports.

Example To display configuration and status information for interface `port1.0.1`, use the command:

```
awplus# show interface port1.0.1
```

Figure 12-1: Example output from the **show interface** command

```
awplus# show interface 1.0.1
Interface port1.0.1
Scope: both
Link is UP, administrative state is UP
Thrash-limiting
Status Not Detected, Action link-down, Timeout 60(s)
Hardware is Ethernet, address is 0000.cd24.daeb
index 5001 metric 1 mru 1500
<UP,BROADCAST,RUNNING,MULTICAST>
VRF Binding: Not bound
SNMP link-status traps: Sending (Suppressed after 20 traps in 60 sec.)
input packets 2396, bytes 324820, dropped 0, multicast packets 2370
output packets 73235, bytes 4906566, multicast packets 73218 broadcast packets 7

awplus# show interface 4.0.1
Interface port4.0.1
Scope: both
Link is DOWN, administrative state is UP
Thrash-limiting
Status Unknown, Action learn-disable, Timeout 1(s)
Hardware is Provisioned, address is 0000.0000.0000
index 8001 metric 1 mru 1500
<BROADCAST,MULTICAST>
VRF Binding: Not bound
SNMP link-status traps: Disabled
input packets 0, bytes 0, dropped 0, multicast packets 0
output packets 0, bytes 0, multicast packets 0 broadcast packets 0
```

Figure 12-2: Example output from the **show interface** command showing the **MRU** size for a switch port

```
awplus#show interface port1.0.21
Interface port1.0.21
Scope: both
Link is UP, administrative state is UP
Thrash-limiting
Status Not Detected, Action learn-disable, Timeout 1(s)
Hardware is Ethernet, address is 0015.77e9.5c50
index 5021 metric 1 mtu 1500 mru 1522
current duplex full, current speed 100, polarity auto
configured duplex auto, configured speed auto
<UP,BROADCAST,RUNNING,MULTICAST>
VRF Binding: Not bound
SNMP link-status traps: Disabled
input packets 295877, bytes 58201312, dropped 0, multicast packets 404
output packets 472528, bytes 79692615, multicast packets 173476 broadcast
packets 76

awplus#show interface port1.0.1
Interface port1.0.1
Scope: both
Link is DOWN, administrative state is UP
Thrash-limiting
Status Not Detected, Action learn-disable, Timeout 1(s)
Hardware is Ethernet, address is 0015.77e9.5c50
index 5001 metric 1 mtu 1500 mru 1522
<UP,BROADCAST,MULTICAST>
VRF Binding: Not bound
SNMP link-status traps: Disabled
input packets 0, bytes 0, dropped 0, multicast packets 0
output packets 0, bytes 0, multicast packets 0 broadcast packets 0
```

To display configuration and status information for interface `vlan1`, use the command:

```
awplus# show interface vlan1
```

Figure 12-3: Example output from the **show interface** command showing the **MTU** size for a VLAN interface

```
awplus#show interface vlan1
Interface vlan1
  Scope: both
  Link is UP, administrative state is UP
  Hardware is VLAN, address is 0015.77e9.5c50
  IPv4 address 192.168.1.1/24 broadcast 192.168.1.255
  index 201 metric 1 mtu 1500
  arp ageing timeout 300
  <UP,BROADCAST,RUNNING,MULTICAST>
  VRF Binding: Not bound
  SNMP link-status traps: Disabled
  Bandwidth 1g
    input packets 295606, bytes 56993106, dropped 5, multicast packets 156
    output packets 299172, bytes 67379392, multicast packets 0 broadcast packets 0

awplus#show interface vlan2
Interface vlan2
  Scope: both
  Link is DOWN, administrative state is UP
  Hardware is VLAN, address is 0015.77e9.5c50
  IPv4 address 192.168.2.1/24 broadcast 192.168.2.255
  Description: ip_phone_vlan
  index 202 metric 1 mtu 1500
  arp ageing timeout 300
  <UP,BROADCAST,MULTICAST>
  VRF Binding: Not bound
  SNMP link-status traps: Disabled
  Bandwidth 1g
    input packets 0, bytes 0, dropped 0, multicast packets 0
    output packets 90, bytes 4244, multicast packets 0 broadcast packets 0
```

Related Commands [mtu](#)
 [show interface brief](#)

show interface brief

Use this command to display brief interface, configuration, and status information, including provisioning information.

For information on output options, see [“Controlling “show” Command Output” on page 1.35.](#)

Syntax `show interface brief`

Mode User Exec and Privileged Exec

Output [Figure 12-4: Example output from the `show interface brief` command](#)

```
awplus>show interface brief
Interface      Status          Protocol
port1.0.1      admin up        down
port1.0.2      admin up        down
port1.0.3      admin up        down
port1.0.4      admin up        down
.
.
port1.0.24     admin up        down
port1.1.1      admin up        provisioned
vlan1          admin up        down

awplus>show interface port1.0.1-1.0.5,vlan1 brief
Interface      Status          Protocol
port1.0.1      admin up        down
port1.0.2      admin up        down
port1.0.3      admin up        down
port1.0.4      admin up        down
port1.0.5      admin up        down
vlan1          admin up        down
```

Table 12-1: Parameters in the output of the `show interface brief` command

Parameter	Description
Interface	The name or type of interface.
Status	The administrative state. This can be either admin up or admin down
Protocol	The link state. This can be either down , running , or provisioned

Related Commands [show interface](#)

show interface status

Use this command to display the status of the specified interface or interfaces. Note that when no interface or interfaces are specified then the status of all interfaces on the switch are shown.

Syntax `show interface [<port-list>] status`

Parameter	Description
<port-list>	<p>The ports to display information about. The port list can be:</p> <ul style="list-style-type: none"> ■ a switch port (e.g. <code>port1.2.12</code>) a static channel group (e.g. <code>sa3</code>) or a dynamic (LACP) channel group (e.g. <code>po3</code>) ■ a continuous range of ports separated by a hyphen, e.g. <code>port1.0.1-1.0.24</code>, or <code>sa1-2</code>, or <code>po1-4</code> ■ a comma-separated list of ports and port ranges, e.g. <code>port1.0.1, port1.1.1-1.2.24</code>. Do not mix switch ports, static channel groups, and dynamic (LACP) channel groups in the same list.

Examples To display the status of ports 1.0.1 to 1.0.5, use the commands:

```
awplus# show interface port1.0.1-1.0.5 status
```

To display the status of all ports, use the commands:

```
awplus# show interface status
```

Figure 12-5: Example output from the `show interface status` command

```
awplus>show interface status
Port      Name           Status      Vlan      Duplex    Speed  Type
port1.0.1 Trunk_Net      connected   trunk     a-full    a-1000 1000BaseTX
port1.0.2 Access_Net1  connected   5         full      100     1000BaseTX
port1.0.3 Access_Net1  disabled    5         auto      auto     1000BaseTX
port1.0.4 Access_Net2  connected   6         a-half    a-100    1000BaseTX
port1.0.5 Private_Prom  connected   10        a-full    a-100    1000BaseTX
port1.0.6 Private_Net1  connected   10,11     a-full    a-100    1000BaseTX
port1.0.7 Private_Net2  connected   10,12     a-full    a-100    1000BaseTX
port1.0.8
:
:
port1.0.23 disabled      1         auto      auto     not present
port1.0.24 notconnect    1         auto      auto     unknown
sa1         notconnect    trunk     auto      auto
```

Table 12-2: Parameters in the output from the **show interface status** command

Parameter	Description
Port	Name/Type of the interface.
Name	Description of the interface.
Status	The administrative and operational status of the interface; one of: <ul style="list-style-type: none"> ■ disabled: the interface is administratively down. ■ connect: the interface is operationally up. ■ notconnect: the interface is operationally down.
Vlan	VLAN type or VLAN IDs associated with the port: <ul style="list-style-type: none"> ■ When the VLAN mode is trunk, it displays trunk (it does not display the VLAN IDs). ■ When the VLAN mode is access, it displays the VLAN ID. ■ When the VLAN mode is private promiscuous, it displays the primary VLAN ID if it has one, and promiscuous if it does not have a VLAN ID. ■ When the VLAN mode is private host, it displays the primary and secondary VLAN IDs. ■ When the port is an Eth port, it displays none: there is no VLAN associated with it. ■ When the VLAN is dynamically assigned, it displays the current dynamically assigned VLAN ID (not the access VLAN ID), or dynamic if it has multiple VLANs dynamically assigned.
Duplex	The actual duplex mode of the interface, preceded by a- if it has autonegotiated this duplex mode. If the port is disabled or not connected, it displays the configured duplex setting.
Speed	The actual link speed of the interface, preceded by a- if it has autonegotiated this speed. If the port is disabled or not connected, it displays the configured speed setting.
Type	The type of interface, e.g., 1000BaseTX. For SFP bays, it displays Unknown if it does not recognize the type of SFP installed, or Not present if an SFP is not installed or is faulty.

Related Commands [show interface](#)

shutdown

This command shuts down the selected interface. This administratively disables the link and takes the link down at the physical (electrical) layer.

Use the **no** variant of this command to disable this function and therefore to bring the link back up again.

Syntax shutdown

no shutdown

Mode Interface Configuration

Example The following example shows the use of the `shutdown` command to shut down `port1.0.20`.

```
awplus# configure terminal
awplus(config)# interface port1.0.20
awplus(config-if)# shutdown
```

The following example shows the use of the `no shutdown` command to bring up `port1.0.12`.

```
awplus# configure terminal
awplus(config)# interface port1.0.12
awplus(config-if)# no shutdown
```

Chapter 13: Interface Testing Commands



Command List	13.2
clear test interface	13.2
service test	13.3
test interface	13.4

Command List

This chapter provides an alphabetical reference of commands used for testing interfaces.

clear test interface

This command clears test results and counters after issuing a test interface command. Test results and counters must be cleared to issue subsequent test interface commands later on.

Syntax `clear test interface {<port-list>|all}`

Parameter	Description
<port-list>	<p>The ports to test. A port-list can be:</p> <ul style="list-style-type: none"> ■ a switch port (e.g. port1.1.12) ■ a continuous range of ports separated by a hyphen, e.g. port1.1.1-port1.1.24 ■ a comma-separated list of the above, e.g. port1.0.1,port1.1.1-1.2.24. <p>The specified ports must exist.</p>
all	All interfaces

Mode Privileged Exec

Examples To clear the counters for port1.0.1 use the command:

```
awplus# clear test interface port1.0.1
```

To clear the counters for all interfaces use the command:

```
awplus# clear test interface all
```

To clear the counters for ports 1 to 12 on XEM 1 (port1.1.1 through port1.1.12) apply:

```
awplus# clear test interface port1.1.1-port1.1.12
```

Related Commands [test interface](#)

service test

This command puts the device into the interface testing state, ready to begin testing. After entering this command, enter Interface Configuration mode for the desired interfaces and enter the command [test interface](#).

Do not test interfaces on a device that is part of a live network—disconnect the device first.

Use the **no** variant of this command to stop the test service.

Syntax `service test`
`no service test`

Mode Global Configuration

Example To put the device into a test state, use the command:

```
awplus(config)# service test
```

Related Commands [test interface](#)

test interface

This command starts a test on a port or all ports or a selected range or list of ports.

Use the **no** variant of this command to disable this function. The test duration can be configured by specifying the time in minutes after specifying a port or ports to test.

For an example of all the commands required to test switch ports, see the Examples section in this command. To test the Eth port, set its speed to 100 by using the command **speed 100**.

- Do not run test interface on live networks because this will degrade network performance.

Syntax `test interface {<port-list>|all} [time{<1-60>|cont}]`
`no test interface {<port-list>|all}`

Parameter	Description
<port-list>	The ports to test. A port-list can be: <ul style="list-style-type: none"> ■ a switch port (e.g. port1.1.12) ■ a continuous range of ports separated by a hyphen, e.g. port1.1.1-port1.1.24 ■ a comma-separated list of the above, e.g. port1.0.1,port1.1.1-1.2.24. The specified ports must exist.
all	All ports
time	Keyword entered prior to the value for the time duration of the interface test.
<1-60>	Specifies duration of time to test the interface or interfaces in minutes (from a minimum of 1 minute to a maximum of 60 minutes). The default is 4 minutes.
cont	Specifies continuous interface testing until cancelled with command negation.

Mode Privileged Exec

Example To test the switch ports in VLAN 1, install loopbacks in the ports, and enter the following commands:

```
awplus(config)# service test
awplus(config)# no spanning-tree rstp enable bridge-forward
awplus(config)# interface vlan1
awplus(config-if)# shutdown
awplus(config-if)# end
awplus# test interface all
```

To see the output, use the commands:

```
awplus# show test
```

```
awplus# show test count
```

To start the test on all interfaces for 1 minute use the command:

```
awplus# test interface all time 1
```

To start the test on ports 1 to 12 for XEM 1 (port1.1.1 through port1.1.12) use the command:

```
awplus# test interface port1.1.1-port1.1.12
```

To stop testing ports 1 to 12 for XEM 1 (port1.1.1 through port1.1.12) use the command:

```
awplus# no test interface port1.1.1-port1.1.12
```

Related Commands [clear test interface](#)

Part 2: Layer Two Switching



- Chapter 14 Switching Introduction
- Chapter 15 Switching Commands
- Chapter 16 VLAN Introduction
- Chapter 17 VLAN Commands
- Chapter 18 Spanning Tree Introduction: STP, RSTP, and MSTP
- Chapter 19 Spanning Tree Commands
- Chapter 20 Link Aggregation Configuration
- Chapter 21 Link Aggregation Commands

Chapter 14: Switching Introduction



Introduction.....	14.2
Physical Layer Information.....	14.3
Switch Ports.....	14.3
Port ranges.....	14.3
Activating and Deactivating Switch Ports.....	14.4
Autonegotiation.....	14.4
Duplex mode.....	14.4
Speed options.....	14.4
Configuring the port speed.....	14.5
MDI MDIX Connection Modes (10BASE-T).....	14.5
Switch Bay Provisioning.....	14.7
Provisioned Board Classes.....	14.7
Applying Hardware Provisioning.....	14.7
Removing or Changing XEM BAY Provisioning.....	14.8
Displaying Provisioned Configurations.....	14.8
Provisioning and Change Management.....	14.10
Provisioning and Software Version Aspects.....	14.11
The Layer 2 Switching Process.....	14.12
The Ingress Rules.....	14.12
The Learning Process.....	14.13
The Forwarding Process.....	14.14
The Egress Rules.....	14.14
Layer 2 Filtering.....	14.15
Ingress Filtering.....	14.15
Static and Dynamic (LACP) Link Aggregation.....	14.16
Static Channel Groups.....	14.16
Dynamic (LACP) Channel Groups.....	14.17
Storm-control.....	14.19
Loop Protection.....	14.20
Loop Detection.....	14.20
Thrash Limiting.....	14.21
Support for Jumbo Frames.....	14.22
Port Mirroring.....	14.22
Port Security.....	14.23
MAC Address Learn Limits.....	14.23
IEEE 802.1X.....	14.23
Quality of Service.....	14.24
IGMP Snooping.....	14.25

Introduction

This chapter gives an overview of Layer 1 and 2 switching.

Layer 2 switches are used to connect multiple Local Area Network (LAN) segments together to form an extended LAN. Stations connected to different LANs can be configured to communicate with one another as if they were on the same LAN. They can also divide one physical LAN into multiple Virtual LANs (VLANs). Stations connected to each other on the same extended LAN can be grouped in separate VLANs, so that a station in one VLAN can communicate directly with other stations in the same VLAN, but must go through higher layer routing protocols to communicate with those stations in other VLANs.

Layer 2 switches appear transparent to higher layer protocols, transferring frames between the data link layers of the networks to which they are attached. A layer 2 switch accesses each physical link according to the rules for that particular network. Access may not always be instant, so the switch must be capable of storing and forwarding frames.

Storing and forwarding enables the switch to examine both the VLAN tag fields and Ethernet MAC address fields in order to forward the frames to their appropriate destination. In this way, the switch can act as an intelligent filtering device, redirecting or blocking the movement of frames between networks.

Because switch ports can sometimes receive frames faster than it can forward them, the switch has Quality of Service (QoS) queues in which frames await transmission according to their priority. Such a situation could occur where data enters a number of input ports all destined for the same output port.

The switch can be used to:

- Increase both the physical extent and the maximum number of stations on a LAN. LANs are limited in their physical extent by the signal distortion and propagation delay characteristics of the media. The switch overcomes this limitation by receiving a frame on one LAN and then retransmitting it to another. The physical characteristics of the LAN media also place a practical limit on the number of stations that can be connected to a single LAN segment. The switch overcomes this limitation by joining LAN segments to form an extended LAN capable of supporting more stations than either of the individual LAN segments.
- Connect LANs that have a common data link layer protocol but different physical media, for example, Ethernet 10BASET, 100BASET, and 10BASEF.
- Increase the availability of LANs by allowing multiple redundant paths to be physically configured and selected dynamically, using the Spanning Tree algorithm.
- Reduce the load on a LAN or increase the effective bandwidth of a LAN, by filtering traffic.
- Prioritize the transmission of data with high Quality of Service requirements.

By using Virtual LANs (VLANs), a single physical LAN can be separated into multiple Virtual LANs. VLANs can be used to:

- Further improve LAN performance, as broadcast traffic is limited to LAN segments serving members of the VLAN to which the sender belongs.
- Provide security, as frames are forwarded to those stations belonging to the sender's VLAN, and not to stations in other VLANs on the same physical LAN.
- Reduce the cost of moving or adding stations to function or security based LANs, as this generally requires only a change in the VLAN configuration.

Physical Layer Information

Switch Ports

A unique port number identifies each switch port. The software supports a number of features at the physical level that allow it to be connected in a variety of physical networks. This physical layer (layer 1) versatility includes:

- Enabling and disabling of ports
- Auto negotiation of port speed and duplex mode for all 10/100 BASE ports
- Manual setting of port speed and duplex mode for all 10/100 BASE ports
- Link up and link down triggers
- Packet storm protection
- Port mirroring
- Support for SNMP management

Port Numbering

Ports are numbered using a 3 digit format x.y.z where x is the device number (within a stacked configuration), y is the module number within the device, and z is the port number within the module. Ports connected directly to the switch chassis (rather than a pluggable module) are given the module number 0. In an unstacked configuration all device numbers are 1. Example, port number 1.2.6 represents device 1, module 2, port 6.

Adding a description

You can add a description to an interface to help identify its purpose or position. For example, to add the description "connected to Nerv" to port1.0.3, use the commands:

```
awplus(config)#interface port1.0.3
awplus(config-if)#description connected to Nerv
```

Port ranges

Continuous To configure a continuous range of ports at the same time, enter the range in the format:

```
portx.y.z-portx.y.z
```

For example, to configure the same interface setting on base switch ports 10-20, enter the Global Configuration mode command:

```
awplus(config)#interface port1.0.10-port1.0.20
```

Non-continuous To configure a non-continuous set of ports at the same time, enter a comma-separated list:

```
portx.y.z,portx.y.z
```

For example, to configure the same interface setting on base switch ports 1 and 5, enter the Global Configuration mode command:

```
awplus(config)#interface port1.0.1,port1.0.5
```

You can combine a hyphen-separated range and a comma-separated list. To configure the same setting on base switch ports 1-3 and 5, enter the Global Configuration mode command:

```
awplus(config)#interface port1.0.1-port1.0.3,port1.0.5
```

Activating and Deactivating Switch Ports

An active switch port is one that is available for packet reception and transmission. Disabling a switch port does not affect the STP operation on the port. By default ports and VLANs are activated.

To shutdown a port or VLAN use the [shutdown command on page 12.12](#). Use the **no** variant of this command to reactivate it.

Autonegotiation

Autonegotiation lets the port adjust its speed and duplex mode to accommodate the device connected to it. When the port connects to another autonegotiating device, they negotiate the highest possible speed and duplex mode for both of them.

By default, all ports autonegotiate. Setting the port to a fixed speed and duplex mode may be necessary when connecting to a device that cannot autonegotiate.

Duplex mode

Ports can operate in full duplex or half duplex mode depending on the type of port it is. When in full duplex mode, a port transmits and receives data simultaneously. When in half duplex mode, the port transmits or receives but not both at the same time.

You can set a port to use either of these options, or allow it to autonegotiate the duplex mode with the device at the other end of the link. To configure the duplex mode

```

awplus#
configure terminal Enter Global Configuration mode
awplus(config)#
interface port1.0.1 Enter Interface Configuration mode for port 1.0.1
awplus(config-if)#
duplex {auto|full|half} Enter the duplex mode for port 1.0.1

```

Speed options

Before configuring a port's speed, check the hardware limit for the particular port type. The following list can be used as a guide:

- copper or fibre SFPs: 1000Mbps
- non-SFP RJ-45 copper switch ports: 10, 100 or 1000 Mbps
- supported tri-speed copper SFPs: 10, 100 or 1000 Mbps
- fibre SFPs: 100 Mbps to 1000Mbps, depending on the SFP type.
- XFP modules: 10 Gbps

For the latest list of approved SFP transceivers either contact your authorized distributor or reseller, or visit <http://www.alliedtelesis.com>

You can set a port to use one of these speed options, or allow it to autonegotiate the speed with the device at the other end of the link.

Most types of switch port can operate in either full duplex or half duplex mode. In full duplex mode a port can transmit and receive data simultaneously. In half duplex mode the port can either transmit or receive, but not at the same time.

Make sure that the configuration of the switch matches the configuration of the device at the far end of the link. In particular, avoid having one end autonegotiate duplex mode while the other end is fixed. For example, if you set one end of a link to autonegotiate and fix the other end at full duplex, the autonegotiating end cannot determine that the fixed end is full duplex capable. Therefore, the autonegotiating end selects half-duplex operation. This results in a duplex mismatch and packet loss. To avoid this, either fix the mode at both ends, or use autonegotiation at both ends.

Configuring the port speed

To set the port speed to 1000 kbps on port 1.0.1

```
awplus#  
configure terminal Enter the Global Configuration mode.  
awplus(config)#  
interface port1.0.1 Enter Interface Configuration mode for port 1.0.1  
awplus(config-if)#  
speed 1000 Set the port speed for port 1.0.1 to 1000 kbps.
```

MDI MDIX Connection Modes (10BASE-T)

The IEEE 802.3 standard defines a series of Media Dependant interface types and their physical connections. For twisted pair (10BASE-T) networking, the standard defines that connectors that conform to the IEC 60603-7 standard. The following diagram shows a connector of this type.

Figure 14-1: Connector used for 10BASE-T networks

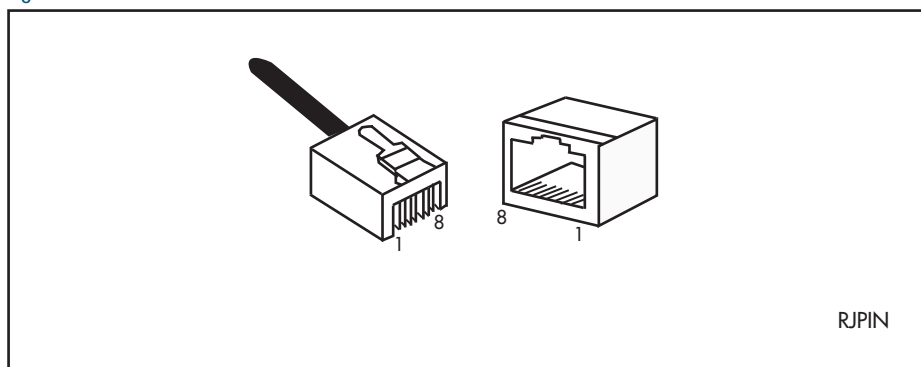

Connections to 10BASE-T networks may either be straight though (MDI) or a crossover. The crossover connection can be achieved by using either a crossover cable or by integrating the crossover function within the device. In the latter situation, the connector referred to as an MDIX connection. Refer to your switch's hardware reference for more detailed information on physical connections cabling.

Configuring MDI MDIX

Although switch ports are set to MDIX by default, you can reconfigure them by using the [polarity command on page 15.30](#).

To set the MDI/MDIX mode for port 1.0.1, use the following commands:

```
awplus#  
configure terminal  Enter the Global Configuration mode.  
awplus(config-if)#  
interface port1.0.1  Enter Interface Configuration mode to configure port 1.0.1  
awplus(config-if)#  
polarity mdi  Set the polarity for port 1.0.1 to MDI.
```

Note that if you override a port's autonegotiation by setting it to a fixed speed and duplex mode, automatic MDI/MDI-X detection is also overridden. Ports have the MDI-X polarity by default.

Switch Bay Provisioning

Switch bay provisioning enables the pre-configuration of interfaces on hardware that is not yet physically present. This enables ports belonging to a XEM bay, or stack member, to be configured in advance, ready for device hot-insertion at a later time.

Provisioning enables a network administrator to pre configure vacant XEM bay on a switch, ready to be hot-swapped in at a later time. Later, when the XEM is physically added, its configuration is automatically applied with the minimum network disruption. Provisioning is ON by default, and cannot be disabled.

Provisioned capacity can be applied by either of the following actions:

- Applying the appropriate provisioning command
- Installing, then removing a provisionable XEM from its bay.

A provisioned interface is assigned the shutdown state and is therefore not able to be activated. Applying the shutdown or no shutdown commands to a provisioned port will change only its administrative state.

Provisioned Board Classes

Provisioning introduces the concept of defined board classes. The following Board Classes have are defined: Each board class is assigned a **class** and an appropriate **port count**. Presently no further definitions have been made for additional features such as media type, or PoE capability. This structure simplifies configuration. For example:

- A single class is required to provision a XEM bay for either the XEM-12s, XEM12-T, or the XEM-12T/PoE modules.

Table 14-1: Provisioned Board Classes

Board Classes	
Class	Port Count
XEM-1	1
XEM-2	2
XEM-12	12

Applying Hardware Provisioning

As previously mentioned, provisioning is the pre-configuration of vacant XEM bay ready for device insertion at a later time.

Without provisioning

On software versions prior to version 5.3.4 - trying to configure port within a vacant XEM bay will result in the following error message:

```
awplus(config)# interface port4.0.1
% Can't find interface port4.0.1
```

With provisioning With provisioning you can configure a XEMs and their ports that are not presently installed, ready for future connection:

The following example sets the port speed of port4.2.1 to be 1000 kbps.

```
awplus(config)# interface port4.2.1
awplus(config-if)# speed 1000
```

You can apply provisional configuration to all interface related commands. However, you cannot apply provisioning where it changes the network topology.

The following example creates a provisioned configuration that shows the association of ports with a VLAN:

```
awplus# configure terminal
awplus(config)# vlan database
awplus(config-vlan)# vlan 12 state enable
awplus(config-vlan)# exit
awplus(config)# interface port2.1.1
awplus(config-if)# switchport mode access
awplus(config-if)# switchport access vlan 12
awplus(config-if)# exit
awplus(config)# interface port2.1.2-port2.1.26
awplus(config-if)# switchport mode access
```

Removing or Changing XEM BAY Provisioning

You cannot un-provision currently installed hardware. Provisioning changes will only be retained if the configuration is saved prior to rebooting.

Displaying Provisioned Configurations

The major difference associated with provisioning, is that interface configurations will still exist in the config files and will appear in show commands, even though a device itself may not be physically installed. Provisioning could result from device capability that has been preconfigured for future installation, or could result from the removal of an installed device.

The **show running-config** command includes switch commands for existing hardware, plus all non-existent, but provisioned, hardware. The following example output of the **show running-config** command illustrates how provisioned and existing hardware is displayed.

Figure 14-2: Sample display of existing and provisioned show output

```
sh running-config
.
.
switch 1 provision x908
switch 1 bay 1 provision xem-12
switch 1 bay 2 provision xem-12
switch 1 bay 3 provision xem-12
switch 1 bay 5 provision xem-12
switch 1 bay 7 provision xem-1
switch 1 bay 8 provision xem-1
switch 2 provision x908
switch 2 bay 1 provision xem-12
switch 2 bay 2 provision xem-12
switch 2 bay 3 provision xem-1
switch 2 bay 8 provision xem-1
!
interface port1.1.1-1.1.12
  switchport
  switchport mode access
!
interface port1.2.1-1.2.12
  switchport
  switchport mode access
!
interface port1.3.1-1.3.12
  switchport
  switchport mode access
.
.
.end
```

Displaying provisioned hardware status

The status, *present* or *provisioned*, appears in monitoring commands, such as the **show interface brief**. The following sample output from this command shows the provisioning status of two configured stack members.

Figure 14-3: Sample display showing hardware provisioning status

Interface	Status	Protocol	Status
port1.1.1	admin up	running	present
port1.1.2	admin up	down	present
.			
port2.8.1	admin up	down	provisioned

A more detailed inspection of the provisioned port 2.8.1 is shown below. Note that the MAC address of 0000.0000.0000, which is a placeholder value for all provisioned ports. Also note that although the port is in the link DOWN state its administrative state of UP PROVISIONED means that it can be further configured. For example, it can be associated with a VLAN, or added to a link aggregation group etc.

Figure 14-4: Sample display showing provisioning status of a specific port

```
Interface port2.8.1
  Scope: both
  Link is DOWN, administrative state is UP PROVISIONED
  Thrash-limiting
    Status Unknown, Action learn-disable, Timeout 1(s)
  Hardware is Ethernet, address is 0000.0000.0000
  index 6801 metric 1 mtu 1500 mru 1522
  <BROADCAST,MULTICAST>
  VRF Binding: Not bound
  SNMP link-status traps: Disabled
    input packets 0, bytes 0, dropped 0, multicast packets 0
    output packets 0, bytes 0, multicast packets 0 broadcast
  pks0
```

Provisioning and Change Management

A benefit of provisioning is that configuration settings are no longer dependant on the existence of hardware devices. When a device is removed, all the interfaces for that device are shutdown and its provisioning status is set. This means that you can add or remove physical hardware without affecting your network configuration. Of course when ports go down (i.e. are physically removed) there will be other changes to network configuration, as protocols may re-converge or, for example, routes may be removed etc.

XEMs within a switch, can be hot-swapped without the need for re-configuration.

The configuration of a newly inserted device that matches the provisioned board-class is achieved on a best-effort basis. For example inserting a non-POE switch into a stack member location configured for PoE will result in the failure of the PoE configuration commands.

Take care that your provisioned configurations, match with the type of hardware that you plan to install. For example, the XEM-12 configuration shown below has the port speed set for one of its ports:

```
awplus(config)# switch 2 bay 4 provision xem-12
awplus(config)# int port2.4.1
awplus(config-if)# speed 10
```

This will be fine if a XEM-12T is installed; however installing a XEM-12S (a device that cannot run its ports at 10 Mbps) would result in an error condition.

Possible Hardware Provisioning Conflicts

Conflicting provisioning configurations can occur where there is a mismatch between the XEM or switch type that is provisionally configured, and the device that is physically added.

If a XEM-1XP is inserted into a bay provisioned for a XEM-12T, there would be a mismatch between the board-class of the XEM inserted, and the board-class provisioned. In this situation, the provisioned configuration would not be applied, instead the switch would apply its default configuration to the new XEM.

Where conflicting hardware is installed - and then corrected, the result is dependent on whether or not the configuration is saved. The following example describes the two possibilities that this situation presents:

1. A bay provisioned for a XEM-12T is fitted with a XEM-1XP. On realizing the mistake, it is then replaced with a XEM-12T.
 - « In this situation, although the provisioned configuration will have been replaced with the default configuration for the XEM-1XP, when the XEM-12T is installed, its previous (provisioned) configuration will return, because it is part of the switch configuration.
2. A bay provisioned for a XEM-12T is fitted with a XEM-1XP and the configuration is saved. On realizing the mistake, it is then replaced with a XEM-12T.
 - « In this situation, the provisioned configuration will have been replaced with the default configuration for the XEM-1XP. As this new configuration is saved, when the XEM-12T is installed, a default configuration will be applied.

Provisioning and Software Version Aspects

When upgrading to version 5.3.4 or later, the provisioning commands will automatically be added to the running configuration of the switch - all other configuration will remain unchanged.

When downgrading from 5.3.4 (for example from 5.3.4 back to 5.3.3), error messages will result if the configuration has been saved using the 5.3.4 version software. This is because the provisioning commands in the configuration file will be unknown to the 5.3.3 version software.

If the configuration has not been saved with the version 5.3.4 software release, then downgrading will not result in error messages. This is because the saved configuration will not contain provisioning commands. All other commands will be unaffected, and the switch will operate as previously.

The Layer 2 Switching Process

The Layer 2 switching process comprises these related but separate processes:

- [The Ingress Rules](#)
- [The Learning Process](#)
- [The Forwarding Process](#)
- [The Egress Rules](#)

Ingress rules admit or discard frames based on their VLAN tagging.

The Learning process learns the MAC addresses and VLAN membership of frames admitted on each port.

The Forwarding process determines which ports the frames are forwarded to, and the Quality of Service priority with which they are transmitted.

Finally, Egress rules determine for each frame whether VLAN tags are included in the Ethernet frames that are transmitted.

These processes assume that each station on the extended LAN has a unique data link layer address, and that all data link layer frames have a header which includes the source (sender's) MAC address and destination (recipient's) MAC address.

The Ingress Rules

All frames, tagged and untagged, that a VLAN-aware switch receives must be classified into a VLAN. Each received frame is mapped to exactly one VLAN. If an incoming frame is tagged with a valid VLAN identifier (VID) then that VID is used. If an incoming frame is untagged or is priority tagged (a tagged frame with a VID of all zeros), then the switch uses internal VLAN association rules to determine the VLAN it belongs to. The default settings for the ingress rules are to Admit All Frames, and for Ingress Filtering to be on.

Every port belongs to one or more VLANs so every incoming frame has a VID to show which VLAN it belongs. The final part of the Ingress Rules depends on whether Ingress Filtering is enabled for the port. If Ingress Filtering is disabled, all frames are passed on to the Learning process, regardless of which VLAN they belong to. If Ingress Filtering is enabled (by default), frame are admitted only when they have the VID of a VLAN to which the port belongs. Frames are discarded when they do not have an associated VID matching the VLAN assigned to a port.

The possible association rules, in order of precedence, are:

- [IP subnet/IPX network classification](#)
- [protocol classification](#)
- [port classification](#)

The default VLAN classification is based upon the port on which the incoming frame (untagged, or priority tagged) was received. It is possible for an incoming untagged, or priority tagged, frame to match more than one of the association rules.

Each port on the switch can be configured to be one of two modes:

- [only untagged frames - access mode](#)
- [only VLAN-tagged frames - trunk mode](#)

Access Mode

This mode can be used to connect to VLAN unaware devices. Frames to and from access mode ports carry no VLAN tagging information.

Trunk Mode

This mode is used to connect VLAN capable devices. All devices that connect using trunk mode ports must be VLAN aware.

The Learning Process

The learning process uses an adaptive learning algorithm, sometimes called *backward learning*, to discover the location of each station on the extended LAN.

All frames admitted by the ingress rules on any port are passed on to the forwarding process when they are for destinations in the same VLAN. Frames destined for other VLANs are passed to a Layer 3 protocol, such as IP. For every frame admitted, the frame's source MAC address and VID are compared with entries in the forwarding database for the VLAN (also known as a *MAC Address table*) maintained by the switch. When the frame's source address is not in the forwarding database for the VLAN, the address is added and an ageing timer for that entry is started. When the frame's source address is already in the forwarding database, the ageing timer for that entry is restarted.

By default, switch learning is enabled. It can be disabled with the `no mac address-table acquire` command, and re-enabled using the `mac address-table acquire` command on page 15.13.

If the ageing timer for an entry in the forwarding database expires before another frame with the same source address is received, the entry is removed from the forwarding database. This prevents the forwarding database from being filled with information about stations that are inactive or have been disconnected from the network. It also ensures that entries for active stations are kept alive in the forwarding database.

By default, the ageing timer is enabled with a default ageing-time. The ageing timer can be reset to the default with the `no mac address-table ageing-time` command. The ageing timer can be increased or decreased using the `mac address-table ageing-time` command.

If switch learning is disabled and the ageing timer has aged out all dynamically learned filter entries, only statically entered MAC source addresses decide the packets to forward or discard. When the switch finds no matching entries in the forwarding database during the forwarding process, all switch ports in the VLAN are flooded with the packet, except the port that received it.

The default value for the mac address-table ageing-time is 300 seconds (5 minutes) and can be modified by using the command `mac address-table ageing-time`. The `no mac address-table ageing-time` command will reset the ageing-time back to the default value (5 minutes).

To set the mac address-table ageing-time to 1000 seconds:

```
awplus#  
configure terminal  Enter the config terminal mode  
awplus(config)#  
mac address-table ageing-time 1000  Set the ageing time to 1000 seconds
```

To display general switch settings, including settings for switch learning and the switch ageing timer, use the `show system` command on page 8.40.

The Forwarding Process

After a VID is assigned to a frame using the ingress rules, the switch forwards it to the destination MAC address specified in the frame. To do this the switch must learn which MAC addresses are available on each port for each VLAN. When the destination MAC address is not found, the switch floods the frame on all ports that are members of the VLAN except the port on which the frame was received.

The forwarding database (also known as the *MAC Address table*) determines the egress port on which the destination MAC address has been learned. MAC addresses are learned dynamically as part of the layer two switching process.

The forwarding database is ordered according to MAC address and VLAN identifier. This means a MAC address can appear more than once in the forwarding database having been learned on the same port but for different VLANs. This could occur if the IP address of an end station is changed thereby moving the end station to a different IP subnet-based VLAN while still connected to the same switch port. When the forwarding database ageing process is enabled, old entries in the forwarding database are deleted after a user-configurable period.

If the destination address is found, the switch discards the frame when the port is not in the STP forwarding or disabled state if the destination address is on the same port as the source address, or if there is a static filter entry for the destination address set to **discard** (see [“Layer 2 Filtering” on page 14.15](#)). Otherwise, the frame is forwarded on the indicated port.

Forwarding occurs only when the port on which the frame was received is in the Spanning Tree forwarding or disabled state. The destination address is then looked up in the forwarding database for the VLAN.

The Egress Rules

After the forwarding process has determined from which ports and transmission queues to forward a frame, the egress rules for each port determine whether the outgoing frame is VLAN-tagged with its numerical VLAN identifier (VID).

A port must belong to a VLAN at all times unless the port has been set as the mirror port for the switch.

A port can transmit VLAN-tagged frames for any VLAN to which the port belongs. A port can transmit untagged frames for any VLAN for which the port is configured, e.g. IP subnet-based or protocol-based, unless prevented by the port-based VLAN egress rules. A port that belongs to a port-based VLAN can transmit untagged packets for only one VLAN. For more information about VLANs and VLAN tagging, see [Chapter 16, VLAN Introduction](#).

For more information on port tagging see the following commands:

[switchport mode access command on page 17.9](#)

[switchport mode trunk command on page 17.11](#)

Layer 2 Filtering

The switch has a forwarding database (also known as the *MAC address table*) whose entries determine whether frames are forwarded or discarded over each port. Entries in the forwarding database are created dynamically by the learning process. A dynamic entry is automatically deleted from the forwarding database when its ageing timer expires.

The forwarding database supports queries by the forwarding process as to whether frames with given values of the destination MAC address field should be forwarded to a given port.

For each VLAN, the destination MAC address of a frame to be forwarded is checked against the forwarding database. If there is no entry for the destination address and VLAN, the frame is transmitted on all ports in the VLAN that are in the forwarding or disabled state, except the port on which the frame was received. This process is referred to as *flooding*. If an entry is found in the forwarding database but the entry is not marked *forwarding* or the entry points to the same port the frame was received on, the frame is discarded. Otherwise, the frame is transmitted on the port specified by the forwarding database.

Ingress Filtering

The `ingress-filter` parameter of the [switchport mode trunk command on page 17.11](#) and the [switchport mode access command on page 17.9](#), enables or disables ingress filtering of frames entering the specified port (or port range). Each port on the switch belongs to one or more VLANs. If ingress filtering is enabled, any frame received on the specified port is only admitted if its VID matches one for which the port is tagged. Any frame received on the port is discarded if its VID does not match one for which the port is tagged.

Untagged frames are admitted and are assigned the VLAN Identifier (VID) of the port's native VLAN. Ingress filtering can be turned off by setting the `disable` parameter of the above two commands. The default setting of the `enable / disable` parameter option is `enable`.

Note  Enabling the `vlan-disable` parameter of the [thrash-limiting command on page 15.63](#) will also enable ingress filtering, and will override the setting of the switchport mode access, and trunk commands

Static and Dynamic (LACP) Link Aggregation

Channels, either static or dynamic LACP, increase reliability by distributing the data path over more than one physical link. Channels must be configured on both ends of a link or network loops may result. Ports in a channel group need not be contiguous. A mirror port cannot be a member of either a static or a dynamic channel group.

Aggregation criteria

For individual links to be aggregated into a channel group they must:

- originate on the same device or stack
- terminate on the same device or stack
- be members of the same VLANs ([vlan command on page 17.22](#))
- have the same data rate ([speed command on page 15.56](#))
- share the same admin port key (assigned by using the [channel-group mode command on page 21.3](#) command)
- be operating in full duplex mode ([duplex command on page 15.9](#))

The hardware must also be capable and have the capacity to handle the number of links to be aggregated.

Static Channel Groups

A static channel group, also known as a static aggregator, enables a number of ports to be manually configured to form a single logical connection of higher bandwidth. By using static channel groups you increase channel reliability by distributing the data path over more than one physical link.

The following example creates a static channel group and adds switch ports 1.0.1 and 1.0.2.

```

awplus# Enter Global Configuration mode.
configure terminal
awplus(config)# Enter the Config-Interface mode to configure port
interface port1.0.1 1.0.1
awplus(config-if)# Add port 1.0.1 to static-channel-group 2.
static-channel-group 2
awplus(config-if)# Return to Global Configuration mode.
exit
awplus(config)# Enter Interface Configuration mode to configure port
interface port1.0.2 1.0.2.
awplus(config-if)# Add port 1.0.2 to static-channel-group 2.
static-channel-group 2

```

For details of static channel group commands, see [Chapter 21, Link Aggregation Commands](#).

Dynamic (LACP) Channel Groups

A LACP channel group, also known as an etherchannel, a LACP aggregator, or a dynamic channel group, enables a number of ports to be dynamically combined to form a single higher bandwidth logical connection.

Note  LACP does not perform load balancing. The LACP algorithm is based on the packet flow. Link aggregation (LAG) hashes the source and destination MAC address, IP address and UDP/TCP ports to select a port on which to send a packet. So packet flow between a pair of hosts always takes the same port inside the LAG. The net effect is that the bandwidth for one packet stream is restricted to the speed of one link in the LAG. For example, for a 2 Gbps LAG that is a combination of two 1 Gbps ports, one flow of traffic can only ever reach a maximum throughput of 1 Gbps.

Note  For information about load balancing see the [platform load-balancing](#) command.

Link Aggregation Control Protocol (LACP)

LACP operates where systems are connected over multiple communications links. Once LACP has been initially configured and enabled, it automatically creates etherchannels and assigns appropriate links to their membership. LACP continues to monitor these groups and dynamically adds or removes links to them as network changes occur.

Note  AlliedWare Plus™ supports IEEE 802.3ad link aggregation and uses the Link Aggregation Control Protocol (LACP). LACP does not interoperate with devices that use Port Aggregation Protocol (PAgP).

LACP achieves this by determining:

- which ports are under LACP control ([channel-group mode command on page 21.3](#))
- whether each port is in LACP active or LACP passive mode ([channel-group mode command on page 21.3](#))
- which system has the highest LACP priority ([lACP system-priority command on page 21.6](#))
- the LACP priority of ports ([lACP port-priority command on page 21.6](#))
- whether the LACP timeout is short or long_ ([lACP timeout command on page 21.7](#))

Channel group identification

In order to identify particular channel groups, each group is assigned a link aggregation identifier called a **lag ID**. The lag ID comprises the following components for both the local system (called the Actor) followed by their equivalent components for the remote system (called the Partner):

- system identifier - the MAC address of the system
- port key - An identifier - created by the LACP software
- port priority - set by the [lACP port-priority command on page 21.6](#)
- port number - determined by the device connection

The lag ID can be displayed for each aggregated link by entering the [show etherchannel command on page 21.9](#).

Configuring an LACP channel group

The following example creates LACP channel group 2 and enables link aggregation on switch ports 1.0.1 and 1.0.2 within this channel group. Note that all aggregated ports must belong to the same VLAN.

```
awplus#  
configure terminal Enter Global Configuration mode.  
awplus(config)#  
interface port1.0.1-port1.0.2 Enter the Interface Configuration mode for  
the switch ports to aggregate into the channel  
group.  
awplus(config-if)#  
channel-group 2 mode active Assign the switch ports to channel group 2 in  
active mode. This creates the channel group.
```

For a more detailed LACP configuration example, see [Chapter 20, Link Aggregation Configuration](#). For details of LACP channel group commands, see [Chapter 21, Link Aggregation Commands](#).

Storm-control

The packet storm-control feature enables you to set limits on the reception rate of broadcast, multicast frames and destination lookup failures. You can set separate limits beyond which each of the different packet types are discarded.

Note A destination lookup failure (DLF) is the event of receiving a unicast Ethernet frame with an unknown destination address.



Note On the AT-9900 applying this command to one port will apply it to all ports on the switch.



For more information on applying storm-control, see the [storm-control level command on page 15.58](#) command.

To apply storm-control by limiting broadcasts to 30% on port 1.0.4 (and all other port on the switch)

```
awplus(config-if)#
configure terminal      Enter Global Configuration mode.

awplus(config-if)#
interface port1.0.4    Enter the Interface Configuration mode
                       for the selected port.

awplus(config-if)#
storm-control broadcast level 30  Configure the interface.
```

To turn off storm protection on port 1. 0. 4(and all other ports on the switch)

```
awplus(config-if)#
configure terminal      Enter Global Configuration mode.

awplus(config-if)#
interface port1.0.4    Enter the Interface Configuration mode
                       for the selected port.

awplus(config-if)#
no storm-control broadcast level  Configure the interface.
```

Loop Protection

Loop protection is a general term that embraces several different methods you can apply to protect your network from effects such as broadcast storms that can result from data loops or equipment malfunction. Presently two methods of loop protection are available:

- Loop Detection
- Thrash Limiting

Loop Detection

Introduction

This feature is used to detect loops with a network segment. If a loop is detected then a selected protection mechanism is applied to limit the effect of the loop. The loop protection actions can be applied either to the port at which the loop is detected or to the VLAN within which the loop was detected.

Limiting Actions You can configure loop detection to apply one of the following mechanisms when a loop condition is detected:

- Disable all MAC address learning.
- Block all traffic on the port (or aggregated link) that detected the loop, and take **down** the link.
- Block all traffic on the port (or aggregated link) that detected the loop, but keep the link in the **up** state.
- Block all traffic on a vlan. Note that setting this parameter will also enable ingress filtering. This is the default action.
- Take no action, but log the details.
- Take no action.

Operation

To detect loops this feature operates by transmitting a series of Loop Detection Frames (LDFs) from each switch port out into the network. If no loops exist, then none of these frame should ever return. If a frame returns to its original port, the detection mechanism assumes that there is a loop somewhere in the network and offers a number of protective options.

Each LDF is a layer 2 LLC frame that contains the following components:

- the source MAC address of the originating switch
- the destination MAC address of the non-existent end station 00-00-F4-27-71-01
- VLAN ID (where the port is a tagged member of a VLAN).
- a randomly generated LDF ID number.

You can set the detection mechanism to remember the LDF ID of up to 5 of the most recently transmitted LDF frames. Each of the 5 most recently transmitted frames is compared with every frame that arrives at that same port.

Configuration

To enable loop protection and configure its basic parameters, you use the [loop-protection command on page 15.11](#).

Example To enable the loop-detect mechanism, and generate loop-detect frames once every 5 seconds, use the command:

```
awplus(config)# loop-protection loop-detect ldf-interval 5
```

Note  LDFs are sent sequentially for each VLAN defined to a particular port. For example, if a particular port in this example is a member of 4 VLANs, then the LDFs will be sent from this port at the rate of 4 frames every 5 seconds.

You can now use the [loop-protection action command on page 15.12](#) configure the action that the switch will take if a loop is detected.

Example To disable an interface, and bring the link down, when a network loop is detected, use the command:

```
awplus(config-if)# loop-protection action link-down
```

Now decide how long you want the protective action to apply for. You configure this function by using the [loop-protection timeout command on page 15.13](#).

Example To configure a loop protection action timeout of 10 seconds, use the command:

```
awplus(config-if)# loop-protection timeout 10
```

Thrash Limiting

MAC address thrashing occurs when MAC addresses move rapidly between one or more ports or trunks, for example, due to a network loop.

Thrash limiting enables you to apply actions to a port when thrashing is detected. It is supported on all port types and also on aggregated ports.

Limiting Actions There are several different thrash actions that you can apply to a port when thrashing is detected. These actions are:

- **learnDisable**
Address learning is temporarily disabled on the port.
- **portDisable**
The port is logically disabled. Traffic flow is prevented, but the link remains up. The device at the other end does not notice that the port has changed status, and the link LEDs at both ends stay on.
- **linkDown**
The port is physically disabled and the link is down. This is equivalent to entering the [shutdown command on page 12.12](#).
- **vlanDisable**
The port is disabled only for the VLAN on which thrashing has occurred. It can still receive and transmit traffic for any other VLANs of which it is a member.

When a MAC address is thrashing between two ports, one of these ports (the first to cross its thrashing threshold) is disabled. All other ports on the device will then have their threshold counters reset.

To set a thrash action for a port, use the [thrash-limiting command on page 15.63](#):

To view the thrash action that is set for a port, use the [show interface switchport command on page 15.32](#):

Re-enabling a port

When a port is disabled, either completely or for a specific VLAN, it remains disabled until it is manually re-enabled in any of the following ways:

- by using SNMP
- by rebooting the switch or stack
- by specifying a thrash timeout value along with the thrash action
- via the CLI

Support for Jumbo Frames

You can enable jumbo frame support on the switch to improve throughput and network utilization. By increasing frame size, more data is put in each packet that the switch has to process.

When jumbo frames support is enabled, the maximum received packet size is:

- 9710 bytes for ports that work at speeds of either 10Mbps or 100Mbps
- 10240 bytes for ports that work at speeds of 1000Mbps

Jumbo frame support is enabled or disabled on the entire switch, not on a per port basis. To enable them, use the [platform jumboframe command on page 15.24](#); to see whether they are enabled, use the [show platform command on page 15.38](#). Jumbo frame support is disabled by default.

Port Mirroring

Port mirroring enables traffic being received and transmitted on a switch port to be sent to another switch port, the mirror port, usually for the purposes of capturing the data with a protocol analyzer.

The mirror port is the only switch port that does not belong to a VLAN, and therefore does not participate in any other switching. Before the mirror port can be set, it must be removed from all trunk groups and all VLANs except the default VLAN. The following example sets mirroring on ports 1.0.2 and 1.0.5 for both incoming and outgoing data.



Note Due to the internal hardware properties of the switch, frames that are destined to leave the mirrored port untagged (i.e. will have their VLAN tag removed on egress) will be received by the mirror port with the tag retained. Consequently, if frames were being transmitted by the mirror port (into the network) at wire speed, then the mirror port might be unable to accept all the frames supplied to it.

To configure port 1.0.2 to mirror port 1.0.5

```
awplus# Enter Global Configuration mode.
configure terminal
awplus(config)# Enter the Interface Configuration mode for
interface port1.0.2 port 1.0.2.
awplus(config-if)# Configure this port to mirror port 1.0.5.
mirror interface port1.0.5
direction both
```

Port Security

The port security features provide control over the stations connected to each switch port. These comprise:

- MAC address learn limits
- IEEE 802.1X

MAC Address Learn Limits

MAC address limiting is applied using the [switchport port-security command on page 15.60](#). If enabled on a port, the switch will learn MAC addresses up to a user-defined limit from 1 to 256, then lock out all other MAC addresses. One of the following options can be specified for the action taken when an unknown MAC address is detected on a locked port:

- Discard the packet and take no further action.
- Discard the packet and notify management with an SNMP trap.
- Discard the packet, notify management with an SNMP trap and disable the port.

IEEE 802.1X

IEEE 802.1X restricts unauthenticated devices from connecting to the switch. After authentication is successful, traffic is allowed through the switch. For more information see [Chapter 54, 802.1X Configuration](#).

Quality of Service

Quality of Service (QoS) enables you to both prioritize traffic and limit its available bandwidth. The concept of QoS is a departure from the original networking protocols, in which all traffic on the Internet or within a LAN had the same available bandwidth. Without QoS, all traffic types are equally likely to be dropped if a link becomes oversubscribed. This approach is now inadequate in many networks, because traffic levels have increased and networks often carry time-critical applications such as streams of real-time video data. QoS also enables service providers to easily supply different customers with different amounts of bandwidth.

Configuring Quality of Service involves two separate stages:

1. Classifying traffic into flows, according to a wide range of criteria. Classification is performed by the switch's class maps.
2. Acting on these traffic flows.

The switch's QoS functionality includes the following:

- policies, to provide a QoS configuration for a port or ports
- traffic classes, for bandwidth limiting and user prioritization
- maximum bandwidth limiting on a traffic class
- flow groups within traffic classes, for user prioritization
- control of the egress scheduling algorithm
- priority relabelling of frames, at Layer 2, by replacing the VLAN tag User Priority field
- class of service relabelling of frames, at Layer 3, by replacing the DSCP (DiffServ Code Point) or the TOS precedence value in the IP header's Type of Service (TOS) field.

For more information on QoS see [Chapter 52, Quality of Service \(QoS\)](#) and [Chapter 53, QoS Commands](#).

IGMP Snooping

IGMP (Internet Group Management Protocol) is used by IP hosts to report their multicast group memberships to routers and switches. IP hosts join a multicast group to receive broadcast messages directed to the multicast group address. IGMP is an IP-based protocol and uses IP addresses to identify both the multicast groups and the host members. For a VLAN-aware devices, this means multicast group membership is on a per-VLAN basis. If at least one port in the VLAN is a member of a multicast group, by default multicast packets will be flooded onto all ports in the VLAN.

IGMP snooping enables the switch to forward multicast traffic intelligently on the switch. The switch listens to IGMP membership reports, queries and leave messages to identify the switch ports that are members of multicast groups. Multicast traffic will only be forwarded to ports identified as members of the specific multicast group.

IGMP snooping is performed at Layer 2 on VLAN interfaces automatically. By default, the switch will forward traffic only from those ports with multicast listeners, therefore it will not act as a simple hub and flood all multicast traffic out all ports. IGMP snooping is independent of the IGMP and Layer 3 configuration, so an IP interface does not have to be attached to the VLAN, and IGMP does not have to be enabled or configured.

IGMP snooping is enabled by default.

Chapter 15: Switching Commands



Command List	15.3
clear loop-protection counters	15.3
clear mac address-table static	15.4
clear mac address-table dynamic	15.5
clear port counter	15.6
debug loopprot	15.6
debug platform packet	15.7
duplex	15.9
flowcontrol	15.10
loop-protection	15.11
loop-protection action	15.12
loop-protection timeout	15.13
mac address-table acquire	15.13
mac address-table ageing-time	15.14
mac address-table static	15.15
mac address-table thrash-limit	15.16
mirror interface	15.17
platform bist	15.18
platform control-plane-prioritization rate	15.19
platform delay-locked-loop-monitoring	15.21
platform enhancedmode	15.22
platform jumboframe	15.24
platform load-balancing	15.25
platform portstorm	15.26
platform prbs	15.27
platform routingratio	15.28
platform vlan-stacking-tpid	15.29
polarity	15.30
show debugging loopprot	15.30
show debugging platform packet	15.31
show flowcontrol interface	15.32
show interface switchport	15.32
show loop-protection	15.33
show mac address-table	15.34
show mac address-table thrash-limit	15.35
show mirror	15.36
show mirror interface	15.37
show platform	15.38
show platform bist	15.39
show platform classifier statistics utilization brief	15.40
show platform counter ipv4	15.42
show platform full debug	15.43
show platform port	15.44
show platform portstorm	15.47
show platform prbs	15.48
show platform register	15.49
show platform swtable	15.50

show platform table.....	15.51
show port-security interface	15.52
show port-security intrusion	15.53
show provisioning (xem-bay).....	15.54
show storm-control	15.55
speed	15.56
storm-control level.....	15.58
switch bay provision	15.59
switchport port-security	15.60
switchport port-security aging.....	15.60
switchport port-security maximum.....	15.61
switchport port-security violation.....	15.62
thrash-limiting	15.63
undebug platform packet.....	15.64
undebug loopprot.....	15.64

Command List

This chapter provides an alphabetical reference of commands used to configure switching. For more information see [Chapter 14, Switching Introduction](#).

clear loop-protection counters

Use this command to clear the counters for the Loop Protection counters.

Syntax `clear loop-protection [interface <port-list>] counters`

Parameters	Description
<code>interface</code>	The interface whose counters are to be cleared.
<code><port-list></code>	A port, a port range, or an aggregated link.

Mode User Exec and Privileged Exec

Examples To clear the counter information:

```
awplus# clear loop-protection counters
```

```
awplus# clear loop-protection interface port1.0.1 counters
```

clear mac address-table static

Use this command to clear the filtering database of all statically configured entries for a selected MAC address, interface, or VLAN.

Syntax `clear mac address-table static`
`[address <mac-address>|vlan <vid>|interface <port>]`

Parameter	Description
<code>vlan</code>	Filtering database entries for the given VLAN.
<code>interface</code>	Filtering database entries for the given port.
<code><vid></code>	The VLAN IDs to be cleared from the database. Value range is 1-4094.
<code><port></code>	The port from which address entries will be cleared. This can be a single port, (e.g. <code>port1.1.4</code>), a static channel group (e.g. <code>sa3</code>), or a dynamic (LACP) channel group (e.g. <code>po4</code>).
<code><mac-address></code>	The mac address to be cleared from the database.

Mode Privileged Exec

Usage Use this command with options to clear the filtering database of all entries made from the CLI for a given MAC address, interface or VLAN. Use this command without options to clear any entries made from the CLI. Compare this usage with [clear mac address-table dynamic command on page 15.5](#).

Examples This example shows how to clear all filtering database entries configured through the CLI.

```
awplus# clear mac address-table static
```

This example shows how to clear all filtering database entries for a given interface configured through the CLI.

```
awplus# clear mac address-table static interface port1.1.3
```

This example shows how to clear filtering database entries filtering database entries configured through the CLI for a given mac address.

```
awplus# clear mac address-table static address 0202.0202.0202
```

Related Commands [clear mac address-table dynamic](#)
[mac address-table static](#)
[show mac address-table](#)

clear mac address-table dynamic

Use this command to clear the filtering database of all entries learned for a selected MAC address, interface or VLAN.

Syntax `clear mac address-table dynamic`
`[address <mac-address>|vlan <vid>|interface <port>]`

Parameter	Description
<code>interface</code>	Filtering database entries for the given port.
<code><vid></code>	When filtering database entries are cleared based on VLANs. Value range is 1-4094.
<code><port></code>	The port from which address entries will be cleared. This can be a single port, (e.g. <code>port1.1.4</code>), a static channel group (e.g. <code>sa3</code>), or a dynamic (LACP) channel group (e.g. <code>po4</code>).
<code><mac-address></code>	The mac address to be cleared from the database.

Mode Privileged Exec

Usage Use this command with options to clear the filtering database of all entries learned for a given MAC address, interface or VLAN. Use this command without options to clear any learned entries. Compare this usage and operation with the [clear mac address-table static command on page 15.4](#).

Examples This example shows how to clear all dynamically learned filtering database entries for all interfaces, addresses, VLANs.

```
awplus# clear mac address-table dynamic
```

This example shows how to clear all dynamically learned filtering database entries when learned through switch operation for a given MAC address.

```
awplus# clear mac address-table dynamic address 0202.0202.0202
```

Related Commands [clear mac address-table static](#)
[show mac address-table](#)

clear port counter

Use this command to clear the packet counters of the port.

Syntax `clear port counter [<port>]`

Parameter	Description
<port>	The port number or range

Mode User Exec and Privileged Exec

Example To clear the packet counter for port1.0.1

```
awplus# clear port counter port1.0.1
```

Related Commands [show platform port](#)

debug loopprot

This command enables Loop Protection debugging.

The **no** variant of this command disables Loop Protection debugging.

Syntax `debug loopprot {info|msg|pkt|state|nsm|all}`
`no debug loopprot {info|msg|pkt|state|nsm|all}`

Parameter	Description
info	General Loop Protection information.
msg	Received and transmitted Loop Detection Frames (LDFs).
pkt	Echo raw ASCII display of received and transmitted LDF packets to the console.
state	Loop Protection states transitions.
nsm	Network Service Module information.
all	All debugging information.

Mode Privileged Exec and Global Configuration

Example To enable debug for all state transitions, use the command:

```
awplus# debug loopprot state
```

Related Commands [show debugging loopprot](#)
[undebug loopprot](#)

debug platform packet

This command enables platform to CPU level packet debug functionality on the switch.

Use the **no** variant of this command to disable platform to CPU level packet debug. If the result means both send and receive packet debug are disabled, then any active timeout will be cancelled.

Syntax `debug platform packet [recv] [send] [sflow] [timeout <timeout>]
[vlan <vlan-id>]`

`no debug platform packet [recv] [send]`

Parameter	Description
<code>recv</code>	Debug packets received.
<code>send</code>	Debug packets sent.
<code>sflow</code>	Debug sFlow packets.
<code>timeout</code>	Stop debug after a specified time.
<code><timeout></code>	<0-3600>The timeout period, specified in seconds.
<code>vlan</code>	Limit debug to a single VLAN ID specified.
<code><vlan-id></code>	<1-4094> The VLAN ID to limit the debug output on.

Default A 5 minute timeout is configured by default if no other timeout duration is specified.

Mode Privileged Exec and Global Configuration

Usage This command can be used to trace packets sent and received by the CPU. If a timeout is not specified, then a default 5 minute timeout will be applied.

If a timeout of 0 is specified, packet debug will be generated until the **no** variant of this command is used or another timeout value is specified. The timeout value applies to both send and receive debug and is updated whenever the **debug platform packet** command is used.

Examples To enable both receive and send packet debug for the default timeout of 5 minutes, enter:

```
awplus# debug platform packet
```

To enable receive packet debug for 10 seconds, enter:

```
awplus# debug platform packet recv timeout 10
```

To enable packet debug for sFlow packets only for the default timeout of 5 minutes, enter:

```
awplus# debug platform packet sflow
```

To enable send packet debug with no timeout, enter:

```
awplus# debug platform packet send timeout 0
```

To enable VLAN packet debug for VLAN 2 with a timeout duration of 3 minutes, enter:

```
awplus# debug platform packet vlan 2 timeout 150
```

To disable receive packet debug, enter:

```
awplus# no debug platform packet recv
```

Related Commands [show debugging platform packet](#)
[undebug platform packet](#)

duplex

This command changes the duplex mode for the specified port.

By default, ports auto-negotiate duplex mode (except for 100Base-FX ports which do not support auto-negotiation, so default to full duplex mode).

To see the currently-negotiated duplex mode for ports whose links are up, use the command [show interface](#). To see the configured duplex mode (when different from the default), use the command [show running-config](#).

Syntax `duplex {auto|full|half}`

Parameter	Description
<code>auto</code>	Auto-negotiate duplex mode
<code>full</code>	Operate in full duplex mode only
<code>half</code>	Operate in half duplex mode only

Mode Interface Configuration

Usage Switch ports in a static or dynamic (LACP) channel group must have the same port speed and be in full duplex mode. Once switch ports have been aggregated into a channel group, you can set the duplex mode of all the switch ports in the channel group by applying this command to the channel group.

Examples To specify full duplex for `port1.0.4`, enter the following commands:

```
awplus# configure terminal
awplus(config)# interface port1.0.4
awplus(config-if)# duplex full
```

To specify half duplex for `port1.0.4`, enter the following commands:

```
awplus# configure terminal
awplus(config)# interface port1.0.4
awplus(config-if)# duplex half
```

To auto-negotiate duplex mode for `port1.0.4`, enter the following commands:

```
awplus# configure terminal
awplus(config)# interface port1.0.4
awplus(config-if)# duplex auto
```

Related Commands [speed](#)
[show interface](#)

flowcontrol

Use this command to enable flow control, and configure the flow control mode for the switch port.

Use the **no** variant of this command to disable flow control for the specified switch port.

Syntax `flowcontrol receive {off|on}`
`no flowcontrol`

Parameter	Description
<code>receive</code>	When the port receives pause frames, it temporarily stops (pauses) sending traffic.
<code>on</code>	Enable the specified flow control.
<code>off</code>	Disable the specified flow control.

Default By default, flow control is disabled.

Mode Interface Configuration

Usage The flow control mechanism specified by 802.3x is only for full duplex links. It operates by sending PAUSE frames to the link partner to temporarily suspend transmission on the link

Flow control enables connected Ethernet ports to control traffic rates during congestion by allowing congested nodes to pause link operation at the other end. If one port experiences congestion, and cannot receive any more traffic, it notifies the other port to stop sending until the condition clears. When the local device detects congestion at its end, it notifies the remote device by sending a pause frame. On receiving a pause frame, the remote device stops sending data packets, which prevents loss of data packets during the congestion period.

Flow control is not recommended when running QoS or ACLs, because the complex queuing, scheduling, and filtering configured by QoS or ACLs may be slowed by applying flow control.

Examples

```
awplus# configure terminal
awplus(config)# interface port1.0.2
awplus(config-if)# flowcontrol receive on
```

```
awplus# configure terminal
awplus(config)# interface port1.0.2
awplus(config-if)# flowcontrol receive off
```

```
awplus# configure terminal
awplus(config)# interface port1.1.2
awplus(config-if)# no flowcontrol
```

Validation Commands show running-config

loop-protection

Use this command to enable the Loop Protection - loop detection - feature, and configure the detection mechanism parameters.

Use the **no** variant of this command to disable the Loop Protection feature.

Syntax loop-protection loop-detect [ldf-interval <period>] [ldf-rx-window <frames>]

no loop-protection

Parameter	Description
ldf-interval	The time (in seconds) between successive loop-detect frames being sent.
<period>	A period between 5 and 600 seconds. The default is 10 seconds.
ldf-rx-window	The number of transmitted loop detection frames whose details are held for comparing with frames arriving at the same port.
<frames>	A value for the window size between 1 and 5 frames. The default is 3 frames.

Default Loop Protection is disabled.

Mode Global Configuration

Usage Use this command to enable the Loop Protection feature, and configure the detection mechanism, and the detection mechanism parameters.

Example To enable the loop-detect mechanism on the switch, and generate loop-detect frames once every 5 seconds, use the command:

```
awplus# configure terminal
awplus(config)# loop-protection loop-detect ldf-interval 5
```

loop-protection action

Use this command to specify the protective action to apply when a network loop is detected.

Use the **no** variant of this command to reset the loop protection actions to the default action, `vlan-disable`.

Note  Currently the `learn-disable` parameter is not supported. If specified, an error message will be displayed.

Syntax `loop-protection action {learn-disable|link-down|log-only|port-disable|vlan-disable|none}`
`no loop-protection action`

Parameter	Description
<code>learn-disable</code>	Disable MAC address learning
<code>link-down</code>	Block all traffic on a port (or aggregated link) that detected the loop, and take down the link.
<code>log-only</code>	Details of loop conditions are logged. No action is applied to the port (or aggregated link).
<code>port-disable</code>	Block all traffic on interface for which the loop occurred, but keep the link in the up state.
<code>vlan-disable</code>	Block all traffic for the VLAN on which the loop traffic was detected. Note that setting this parameter will also enable ingress filtering. This is the default action.
<code>none</code>	Applies no protective action.

Default `loop-protection action vlan-disable`

Mode Interface Configuration

Example To disable an interface (`port1.0.4`), and bring the link down, when a network loop is detected, use the command:

```
awplus# configure terminal
awplus(config)# interface port1.0.4
awplus(config-if)# loop-protection action link-down
```

loop-protection timeout

Use this command to specify the Loop Protection recovery action duration.

Use the **no** variant of this command to set the loop protection timeout to the default value.

Syntax `loop-protection timeout <duration>`
`no loop-protection timeout`

Parameter	Description
<code><duration></code>	The time (in seconds) for which the configured action will apply before being disabled. This duration can be set between 1 and 86400 seconds (24 hours).

Default The default is 7 seconds.

Mode Interface Configuration

Example To configure a loop protection action timeout of 10 seconds for `port1.0.4`, use the command:

```
awplus# configure terminal
awplus(config)# interface port1.0.4
awplus(config-if)# loop-protection timeout 10
```

mac address-table acquire

Use this command to enable MAC address learning on the device.

Use the **no** variant of this command to disable learning.

Syntax `mac address-table acquire`
`no mac address-table acquire`

Default Learning is enabled by default for all instances.

Mode Global Configuration

Example

```
awplus# configure terminal
awplus(config)# mac address-table acquire
```

mac address-table ageing-time

Use this command to specify an ageing-out time for a learned MAC address. The learned MAC address will persist for at least the specified time.

The **no** variant of this command will reset the ageing-out time back to the default value of 300 seconds (5 minutes).

Syntax `mac address-table ageing-time <ageing-timer> none`
`no mac address-table ageing-time`

Parameter	Description
<code><ageing-timer></code>	<code><10-1000000></code> The number of seconds of persistence.
<code>none</code>	Disable learned MAC address timeout.

Default The default ageing time is 300 seconds.

Mode Global Configuration

Examples

```
awplus# configure terminal
awplus(config)# mac address-table ageing-time 1000

awplus# configure terminal
awplus(config)# mac address-table ageing-time none

awplus# configure terminal
awplus(config)# no mac address-table ageing-time
```

mac address-table static

Use this command to statically configure the MAC address-table to forward or discard frames with a matching destination MAC address.

Syntax

```
mac address-table static <mac-addr> {forward|discard} interface
    <port> [vlan <vid>]

no mac address-table static <mac-addr> {forward|discard} interface
    <port> [vlan <vid>]
```

Parameter	Description
<mac-addr>	The destination MAC address in HHHH.HHHH.HHHH format.
<port>	The port to display information about. The port may be a switch port (e.g. port1.1.4), a static channel group (e.g. sa3), or a dynamic (LACP) channel group (e.g. po4).
<vid>	The VLAN ID. If you do not specify a VLAN, its value defaults to vlan 1.

Mode Global Configuration

Usage The **mac address-table static** command is only applicable to layer 2 switched traffic within a single VLAN. Do not apply the **mac address-table static** command to layer 3 switched traffic passing from one VLAN to another VLAN. Frames will not be discarded across VLANs because packets are routed across VLANs. This command only works on layer 2 traffic.

Example

```
awplus# configure terminal

awplus(config)# mac address-table static 2222.2222.2222 forward
interface port1.1.4 vlan 3
```

Related Commands

- [clear mac address-table static](#)
- [show mac address-table](#)

mac address-table thrash-limit

Use this command to set the thrash limit on the switch or stack. Thrashing occurs when a MAC address table rapidly “flips” its mapping of a single MAC address between two subnets, usually as a result of a network loop.

Use the **no** variant of this command to disable thrash limiting.

Syntax `mac address-table thrash-limit <rate>`
`no mac address-table thrash-limit`

Parameter	Description
<code><rate></code>	sets the maximum thrash rate at which limiting is applied. This rate can be set between 5 and 255 MAC thrashing flips per second. Once the thrash limit rate is reached, the port is considered to be thrashing.

Default No thrash limiting

Mode Global Configuration

Usage Use this command to limit thrashing on the selected port range.

Example To apply a thrash limit of 100 MAC address flips per second:

```
awplus# configure terminal
awplus(config)# mac address-table thrash-limit 100
```

Related Commands [show mac address-table thrash-limit](#)

mirror interface

Use this command to define a mirror port and mirrored (monitored) ports and direction of traffic to be mirrored. The port for which you enter interface mode will be the mirror port.

The destination port is removed from all VLANs, and no longer participates in other switching.

Use the **no** variant of this command to disable port mirroring by the destination port on the specified source port.

Syntax `mirror interface <source-port-list> direction {both|receive|transmit}`
`no mirror interface <source-port-list>`

Parameter	Description
<code><source-port-list></code>	The source switch ports to mirror. A port-list can be: <ul style="list-style-type: none"> ■ a port (e.g. port1.2.12) ■ a continuous range of ports separated by a hyphen, e.g. port1.0.1-1.0.24 or port1.1.1-port1.1.24 ■ a comma-separated list of ports and port ranges, e.g. port1.0.1,port1.1.1-1.2.24 The source port list cannot include dynamic or static channel groups (link aggregators).
<code>direction</code>	Specifies whether to mirror traffic that the source port receives, transmits, or both.
<code>both</code>	Mirroring traffic both received and transmitted by the source port.
<code>receive</code>	Mirroring traffic received by the source port.
<code>transmit</code>	Mirroring traffic transmitted by the source port.

Mode Interface Configuration

Usage Use this command to send traffic to another device connected to the mirror port for monitoring.

See ["Port Mirroring" on page 14.22](#).

A mirror port cannot be associated with a VLAN. If a switch port is configured to be a mirror port, it is automatically removed from any VLAN it was associated with.

This command can only be applied to a single mirror (destination) port, not to a range of ports, nor to a static or dynamic channel group. Do not apply multiple interfaces with an interface command before issuing the mirror interface command. One interface may have multiple mirror interfaces.

Note  A port cannot be configured as a mirror or mirrored port, if it is already configured for sFlow monitoring.

Example To mirror traffic received and transmitted on port1.1.4 and port1.1.5 to destination port1.1.3, use the commands:

```
awplus# configure terminal
awplus(config)# interface port1.1.3
awplus(config-if)# mirror interface port1.1.4,port1.1.5
direction both
```

platform bist

This command performs a self test on the switch. This command tests the ASIC (Application Specific Integrated Circuit) memory.

Syntax platform bist instance {<0-127>|all} [full]

Parameter	Description
instance	ASIC (Application Specific Integrated Circuit) instance.
<0-127>	ASIC instance number.
all	All platform instances.
full	Run full BIST tests.

Mode Privileged Exec

Example To run the full built in self test for all memory in the ASIC on the switch, enter the command:

```
awplus# platform bist instance all full
```

Related Commands platform prbs
show platform bist

platform control-plane-prioritization rate

The CPU protection feature ensures that different traffic types can share the CPU effectively.

Use this command to set the maximum traffic rate on the CPU port to limit the CPU getting overloaded with unnecessary data packets that may result in poor performance of the control plane, for example, CLI console lock up or control packet loss following a broadcast storm.

The default rate limiting value is set to transmit the packets to the CPU at 60 Mbps. The CPU port uses the WRR (Weighted Round Robin) scheduler with appropriate weights assigned.

Use the **no** variant of this command to restore the rate limiting on the CPU port to the default value of 60 Mbps. Note only integer values are accepted for rate limits.

Set the rate to 0 using **platform control-plane prioritization rate** to disable CPU protection.

Syntax `platform control-plane-prioritization rate <rate-limit>`
`no platform control-plane-prioritization rate`

Parameter	Description
<code><rate-limit></code>	<code><1-1000></code> 1 Mbps to 1000 Mbps. Default is 60 Mbps.

Default 60 Mbps

Mode Global Configuration

Usage Confirming default settings:

Use **show platform** to confirm the default rate limit settings displayed with platform information:

```
awplus# show platform
```

```
Load Balancing          srt-dst-mac, src-dst-ip
Control-plane-prioritization Max 60 Mbps
Jumboframe support      off
Enhanced mode           qos counters
Vlan-stacking TPID      0x8100
```

Disabling CPU protection:

To disable the CPU protection feature you can set the control plane prioritization rate to 0:

```
awplus# platform control-plane-prioritization 0
```

Then you can confirm the CPU protection feature has been disabled using **show platform**:

```
awplus# show platform
```

```
Load Balancing                srt-dst-mac, src-dst-ip
Control-plane-prioritization Max 0 Mbps
Jumboframe support            off
Enhanced mode                 qos counters
Vlan-stacking TPID           0x8100
```

Examples To set the maximum traffic rate on the CPU port to 10 Mbps enter the following command, enter:

```
awplus# configure terminal
awplus(config)# platform control-plane-prioritization 10
```

Confirm the maximum traffic rate has been configured using the following **show** command:

```
awplus#show platform
Load Balancing                srt-dst-mac, src-dst-ip
Control-plane-prioritization Max 10 Mbps
Jumboframe support            off
Enhanced mode                 qos counters
Vlan-stacking TPID           0x8100
```

Reset the maximum traffic rate on the CPU port to 60 Mbps using the following **no** command, enter:

```
awplus# configure terminal
awplus(config)# no platform control-plane-prioritization
```

Related Commands [show platform](#)
[show running-config](#)

platform delay-locked-loop-monitoring

This command should only be used when directed by Allied Telesis support personnel. This command allows you to configure the DLL (Delayed Locked Loop) monitoring parameters used for hardware environmental monitoring functionality.

Syntax `platform delay-locked-loop-monitoring <poll-interval> <temp-delta>`

Parameter	Description
<code><poll-interval></code>	<code><1-4294967295></code> Time interval in seconds between two successive temperature readings.
<code><temp-delta></code>	<code><1-200></code> Maximum rise in temperature in degrees Celsius after which the Delay Locked Loop is reset.

Default The default poll interval is 10 seconds, and the default temperature delta is 30 degrees Celsius.

Mode Global Configuration

Usage In field resetting of the Delayed Locked Loop (DLL) may be used under some extreme thermal conditions, such as a reboot at a very low temperature with a ramp-up to a high temperature.

The two integer parameters configured by this command are the values for the time interval in seconds to poll for temperature variations (which is the poll interval), and the temperature limit in degrees Celsius (which is the maximum temperature delta).

Example To set the poll interval to 20 seconds and the temperature delta to 35 degrees Celsius, enter:

```
awplus# configure terminal
awplus(config)# platform delay-locked-loop-monitoring 20 35
```

platform enhancedmode

This command rearranges memory in the silicon so that it can store a greater than usual number of QoS traffic class counters, QoS Policers, or nexthop routes. For the enhanced mode to take effect, you must restart the device after entering this command.

The switch remains in enhanced mode until you change it with a **no platform enhancedmode**.

The **no** variant of this command restores the memory to the default state. You must restart the device after entering this command for it to take effect.

This feature is disabled by default.

Syntax `platform enhancedmode {nexthop|qoscounters|qospolicers}`
`no platform enhancedmode`

Parameter	Description
<code>nexthop</code>	Increases the size of the nexthop table. If you specify this, the silicon stores up to 5000 individual routes (nexthops). The maximum number of multicast groups and traffic classes is reduced.
<code>qoscounters</code>	Enables QoS counters. If you specify this, the silicon monitors QoS counters for traffic classes. The maximum number of traffic classes is reduced. You must set this option before you configure QoS storm protection.
<code>qospolicers</code>	Enables the QoS Policers mode. If you specify this, the internal memory for the switch is rearranged to allow more QoS Policers at the expense of a reduced multicast route capacity (reducing the number of multicast routes to 640 and increasing the number of QoS Policers to 1024).

Default No enhancedmode (`nexthop`, `qoscounters`, `qospolicers`) is set by default, for a total of 1024 Multicast routes and 512 QoS Policers.

Note Memory for multicast routes and QoS Policers is shared on the switch.



Mode Global Configuration

Usage Note that the `qoscounters` option reduces the maximum number of available traffic classes. You must set the `qoscounters` option before you configure QoS storm protection.

You must **copy** the `running-config` to the `startup-config` and **reboot** to change enhancedmode.

Examples To turn monitoring of QoS traffic class counters on, use the following commands:

```
awplus# configure terminal
awplus(config)# platform enhancedmode qoscounters
```

To increase the size of the nexthop table, use the following commands:

```
awplus# configure terminal
awplus(config)# platform enhancedmode nexthop
```

To allow more QoS Policers at the expense of multicast routes, use the following commands:

```
awplus# configure terminal
awplus(config)# platform enhancedmode qospolicers
```

To restore the silicon memory so that the QoS traffic counters are no longer monitored, use the following commands:

```
awplus# configure terminal
awplus(config)# no platform enhancedmode
```

To restore the silicon memory so that the nexthop table returns to its original size, use the following commands:

```
awplus# configure terminal
awplus(config)# no platform enhancedmode
```

To restore silicon memory to allow more multicast routes at the expense of QoS Policers, use the following commands:

```
awplus# configure terminal
awplus(config)# no platform enhancedmode
```

To change the enhancedmode enabled on the switch, use the following commands:

```
awplus# copy running-config startup-config
awplus# reboot
```

Related Commands [copy running-config](#)
[reboot](#)
[show platform](#)
[show running-config](#)

platform jumboframe

This command enables the device to forward jumbo frames. For more information, see [“Support for Jumbo Frames” on page 14.22](#).

When jumbo frame support is enabled, the maximum size of packets that the device can forward is:

- 9710 bytes for ports that work at speeds of either 10Mbps or 100Mbps
- 10240 bytes for ports that work at speeds of 1000Mbps is 10240 bytes.

You must restart the device after entering this command for it to take effect. You can use the [reboot command on page 93.5](#) to restart the device.

The **no** variant of this command disables the device from forwarding jumbo frames. This stops the ports from forwarding packets larger than VLAN tagged frames (1522 bytes).

You must restart the device after entering this command for it to take effect.

This feature is disabled by default.

Syntax `platform jumboframe`
`no platform jumboframe`

Default By default, jumbo frames is off.

Mode Global Configuration

Example To enable the device to forward jumbo frames, use the following commands:

```
awplus# configure terminal
awplus(config)# platform jumboframe
```

Related Commands [show platform](#)
[show running-config](#)

platform load-balancing

This command selects which packet fields are used in the channel load balancing algorithm.

Use the **no** variant of this command to restrict the default choice of packet fields in the channel load balancing algorithm.

The load balancing algorithm determines the member port of a channel group when the packet is destined for a port within a channel.

When Layer 4 (**src-dst-port**) is enabled then Layer 3 (**src-dst-ip**) header information is also used to hash traffic to a port in the channel. When traffic is routed at Layer 3 to a channel group then only Layer 3 header information is used to hash traffic to the ports in the channel group, irrespective of whether **src-dst-mac**, **src-dst-ip** or **src-dst-port** is enabled.

Syntax

```
platform load-balancing {src-dst-mac|src-dst-ip|src-dst-port}
[src-dst-mac|src-dst-ip|src-dst-port]

no platform load-balancing {src-dst-mac|src-dst-ip|src-dst-port}
[src-dst-mac|src-dst-ip|src-dst-port]
```

Parameter	Description
src-dst-mac	Include Source and Destination MAC data (Layer 2)
src-dst-ip	Include Source and Destination IP data (Layer 3)
src-dst-port	Include Source and Destination TCP/UDP port data (Layer 4)

Default The default is **src-dst-mac** and **src-dst-ip**

Mode Global Configuration

Examples To set the load balancing algorithm to include layer 2 MAC information, enter:

```
awplus# configure terminal
awplus(config)# platform load-balancing src-dst-mac
```

To set the load balancing algorithm to exclude layer 2 MAC information, enter:

```
awplus# configure terminal
awplus(config)# no platform load-balancing src-dst-mac
```

To set the load balancing algorithm to include layer 3 IP information, enter:

```
awplus# configure terminal
awplus(config)# platform load-balancing src-dst-ip
```

To set the load balancing algorithm to exclude layer 3 IP information, enter

```
awplus# configure terminal
awplus(config)# no platform load-balancing src-dst-ip
```

To set the load balancing algorithm to include layer 4 port information, enter:

```
awplus# configure terminal
awplus(config)# platform load-balancing src-dst-port
```

To set the load balancing algorithm to exclude layer 4 port information, enter:

```
awplus# configure terminal
awplus(config)# no platform load-balancing src-dst-port
```

platform portstorm

Use this command to perform a port storm test on the system. This test generates a high packet load on switch ports, exercising the packet data path and front-panel ports.

Syntax `platform portstorm [duration <seconds>]`

Parameter	Description
duration	Duration of test.
<seconds>	The duration period, in seconds.

Mode Privileged Exec

Usage For this test, at least three ports must be looped back individually or pair-wise. Normally all ports on a switching instance are included. Additionally, Spanning Tree should be disabled using a `no spanning-tree rstp enable` command before issuing the `platform portstorm` command.

Example To perform a port storm test for 5 minutes on the switch, ensure ports are externally looped back correctly, and use the following commands:

```
awplus# configure terminal
awplus(config)# no spanning-tree rstp enable
awplus(config)# exit
awplus# platform portstorm duration 300
```

Related Commands `show platform portstorm`
`spanning-tree enable`

platform prbs

Use this command to perform a PRBS (Pseudo-Random Bit Stream) test on the system. This test sends a PRBS bidirectionally to and from every fabric port on the switch.

Note  You cannot run this command on a XEM-STK module in an x900. Run a [platform bist](#) command on a XEM-STK instead.

Syntax `platform prbs {internal-fabric|stack-fabric|all-fabric} [duration <seconds>]`

Parameter	Description
<code>internal-fabric</code>	Test the baseboard internal fabric links.
<code>stack-fabric</code>	Test the baseboard stacking fabric links. For x908 switches only.
<code>all-fabric</code>	Run both tests for x908 switches or run the <code>stack-fabric</code> test.
<code>duration</code>	Duration of test.
<code><seconds></code>	The duration period, in seconds.

Mode Privileged Exec

Example To perform a PRBS on the internal fabric links for 5 minutes, use the following command:

```
awplus# platform prbs internal-fabric duration 300
```

Related Commands [platform bist](#)
[show platform prbs](#)

platform routingratio

Description This command changes the amount of memory allocated to IPv4 routing tables relative to IPv6 routing tables.

Use the **no** variant of this command to restore to the default setting.

The switching hardware contains memory that it uses to store tables of routes and nexthop addresses. IPv4 and IPv6 addresses have separate tables. This command adjusts the amount of memory allocated to the tables depending on whether they are for IPv4 or IPv6 addresses.

Syntax `platform routingratio {ipv4only|ipv4andipv6}`
`no platform routingratio`

Parameter	Description
<code>ipv4only</code>	All memory resources are allocated to the IPv4 address tables.
<code>ipv4andipv6</code>	50% of memory resources are allocated to the IPv4 address tables, and 50% to IPv6 address tables.

Default The routing ratio is set to `ipv4andipv6` by default to store both IPv4 and IPv6 addresses.

Mode Global Configuration

Usage The default routing memory ratio is set to `ipv4andipv6` allowing both IPv4 and IPv6 to run concurrently. Use the negated form of this command to restore to the default. If you need to maximize routing memory capacity for IPv4, then set the routing memory ratio to `ipv4only`.

Note  For this command to take effect, you must copy it to the startup configuration using the `copy running-config startup-config` command and then reboot the switch.

Examples To set the route and nexthop tables to store IPv4 addresses only, use the following commands:

```
awplus# configure terminal
awplus(config)# platform routingratio ipv4only
% The device needs to be restarted for this
change to take effect.
```

To reset the route and nexthop tables to store both IPv4 and IPv6 addresses, use the following commands:

```
awplus# configure terminal
awplus(config)# platform routingratio ipv4andipv6
% The device needs to be restarted for this
change to take effect.
```

To reset the route and nexthop tables to the default setting, use the following commands:

```
awplus# configure terminal
awplus(config)# no platform routingratio

% The device needs to be restarted for this
change to take effect.
```

Related Commands [platform enhancedmode](#)
[show platform](#)
[show running-config](#)
[show startup-config](#)

platform vlan-stacking-tpid

This command specifies the Tag Protocol Identifier (TPID) value that applies to all frames that are carrying double tagged VLANs. All nested VLANs must use the same TPID value. (This feature is sometimes referred to as VLAN stacking or VLAN double-tagging.)

Use the **no** variant of this command to revert to the default TPID value (0x8100).

Note  Because the additional tag increases the frame size beyond 1522 bytes, you must turn on Jumbo frames to activate VLAN-stacking.

Syntax `platform vlan-stacking-tpid <tpid>`
`no platform vlan-stacking-tpid <tpid>`

Parameter	Description
<code><tpid></code>	The Ethernet type of the tagged packet, as a two byte hexadecimal number.

Default The default TPID value of 0x8100 is restored using a **no platform vlan-stacking-tpid** command.

Mode Global Configuration

Examples To set the VLAN stacking TPID value to 0x9100, use the following commands:

```
awplus# configure terminal
awplus(config)# platform vlan-stacking-tpid 9100
```

To reset the VLAN stacking TPID value to the default (0x8100), use the following commands:

```
awplus# configure terminal
awplus(config)# no platform vlan-stacking-tpid
```

Related Commands [switchport vlan-stacking \(double tagging\)](#)
[show platform](#)
[show running-config](#)

polarity

This command sets the polarity on a switch port.

Ports auto-negotiate polarity by default.

Syntax `polarity {mdi|mdix|auto}`

Parameter	Description
<code>mdi</code>	Sets the polarity to MDI (medium dependent interface).
<code>mdix</code>	Sets the polarity to MDI-X (medium dependent interface crossover).
<code>auto</code>	The switch port sets the polarity automatically.

Mode Interface Configuration

Usage Note that if you override a port's auto-negotiation by setting a fixed speed and duplex mode, automatic MDI/MDI-X detection is also overridden.

Example To set the polarity for `port1.0.7` to MDI, use the following commands:

```
awplus# configure terminal
awplus(config)# interface port1.0.7
awplus(config-if)# polarity mdi
```

show debugging loopprot

This command shows Loop Protection debugging information.

Syntax `show debugging loopprot`

Mode User Exec

Example To display the enabled Loop Protection debugging modes, use the command:

```
awplus# show debugging loopprot
```

Related Commands [debug loopprot](#)

show debugging platform packet

This command shows platform to CPU level packet debugging information.

Syntax `show debugging platform packet`

Mode Privileged Exec

Example To display the platform packet debugging information, use the command:

```
awplus# show debugging platform packet
```

Related Commands [debug platform packet](#)
[undebug platform packet](#)

show flowcontrol interface

Use this command to display flow control information.

Syntax `show flowcontrol interface <port>`

Parameter	Description
<port>	Specifies the name of the port to be displayed.

Mode User Exec and Privileged Exec

Example To display the flow control for the port1.1.5, use the command:

```
awplus# show flowcontrol interface port1.1.5
```

Output Figure 15-1: Example output from the **show flowcontrol interface** command for a specific interface

Port	Send FlowControl admin oper	Receive FlowControl admin oper	RxPause	TxPause
port1.1.5	on on	on on	0	0

show interface switchport

Use this command to show VLAN information about each switch port.

Syntax `show interface switchport`

Mode User Exec and Privileged Exec

Example To display VLAN information about each switch port, enter the command:

```
awplus# show interface switchport
```

Output Figure 15-2: Example output from the **show interface switchport** command

```

Interface name      : port1.1.1
Switchport mode    : access
Ingress filter     : enable
Acceptable frame types : all
Default Vlan      : 2
Configured Vlans   : 2

Interface name      : port1.1.2
Switchport mode    : trunk
Ingress filter     : enable
Acceptable frame types : all
Default Vlan      : 1
Configured Vlans   : 1 4 5 6 7 8
...

```

show loop-protection

Use this command to display the current loop protection setup for the device.

Syntax `show loop-protection [interface <port-list>] [counters]`

Parameter	Description
interface	The interface selected for display.
<port-list>	A port, a port range, or an aggregated link.
counters	Displays counter information for loop protection.

Mode User Exec and Privileged Exec

Usage This command is used to display the current configuration and operation of the Loop Protection feature

Examples To display the current configuration status for `port1.0.1`, use the command:

```
awplus# show loop-protection interface port1.0.1
```

Figure 15-3: Example output from the `show loop-protection` command

```
Loop-Detection:      Enabled
LDF Interval:       10 [sec]
Interface:          port1.0.1
Action:             port-disable
Timeout:            300 [sec]
Vlan:               1
Status:             Blocking
Timeout Remaining: 115 [sec]
Vlan:               2
Status:             Normal
Timeout Remaining: 0 [sec]
```

To display the counter information for `port1.0.1`, use the command:

```
awplus# show loop-protection interface port1.0.1 counters
```

Figure 15-4: Example output from the `show loop-protection interface counters` command for `port1.0.1`

```
Interface:          port1.0.1
Vlan:              1
LDF Tx:            3
LDF Rx:            1
Invalid LDF Rx:    1
Action:            1
Vlan:              2
LDF Tx:            3
LDF Rx:            0
Invalid LDF Rx:    0
Action:            0
```

show mac address-table

Use this command to display the mac address-table for all configured VLANs.

Syntax `show mac address-table`

Mode User Exec and Privileged Exec

Usage The `show mac address-table` command is only applicable to view a mac address-table for layer 2 switched traffic within VLANs.

Example To display the mac address-table, use the following command:

```
awplus# show mac address-table
```

Output See the below sample output captured when there was no traffic being switched:

```
awplus#show mac address-table

VLAN port          mac                type
1     unknown        0000.cd28.0752    forward  static
ARP   -                0000.cd00.0000    forward  static
```

See the sample output captured when packets were switched and mac addresses were learnt:

```
awplus#show mac address-table

VLAN port          mac                type
1     unknown        0000.cd28.0752    forward  static
1     port1.0.11      0030.846e.9bf4    forward  dynamic
1     port1.0.9       0030.846e.bac7    forward  dynamic
ARP   -                0000.cd00.0000    forward  static
```

Note the new mac addresses learnt for `port1.0.9` and `port1.0.11` added as dynamic entries.

Note the first column of the output below shows VLAN IDs if multiple VLANs are configured:

```
awplus#show mac address-table

VLAN port          mac                type
1     unknown        0000.cd28.0752    forward  static
1     port1.0.9       0030.846e.bac7    forward  dynamic
2     unknown        0000.cd28.0752    forward  static
2     port1.0.11      0030.846e.9bf4    forward  dynamic
ARP   -                0000.cd00.0000    forward  static
```

Also note manually configured static mac-addresses are shown to the right of the type column:

```
awplus(config)#mac address-table static 0000.1111.2222 for int
port1.0.11 vlan 2
awplus(config)#end
awplus#
awplus#show mac address-table
```

VLAN	port	mac	type	
1	unknown	0000.cd28.0752	forward	static
1	port1.0.9	0030.846e.bac7	forward	dynamic
2	port1.0.11	0000.1111.2222	forward	static
2	unknown	0000.cd28.0752	forward	static
2	port1.0.11	0030.846e.9bf4	forward	dynamic
ARP	-	0000.cd00.0000	forward	statics

Related Commands [clear mac address-table dynamic](#)
[clear mac address-table static](#)
[mac address-table static](#)

show mac address-table thrash-limit

Use this command to display the current thrash limit set for all interfaces on the device.

Syntax `show mac address-table thrash-limit`

Mode User Exec and Privileged Exec

Example To display the current, use the following command:

```
awplus# show mac address-table thrash-limit
```

Output Figure 15-5: Example output from the **show mac address-table thrash-limit** command

```
% Thrash-limit 7 movements per second
```

Related Commands [mac address-table thrash-limit](#)

show mirror

Use this command to display the status of all mirrored ports.

Syntax `show mirror`

Mode User Exec and Privileged Exec

Example To display the status of all mirrored ports, use the following command:

```
awplus# show mirror
```

Output Figure 15-6: Example output from the `show mirror` command

```
Mirror Test Port Name: port1.1.1
Mirror option: Enabled
Mirror direction: both
Monitored Port Name: port1.1.2
Mirror Test Port Name: port1.1.3
Mirror option: Enabled
Mirror direction: receive
Monitored Port Name: port1.1.4
Mirror Test Port Name: port1.1.3
Mirror option: Enabled
Mirror direction: receive
Monitored Port Name: port1.1.1
Mirror Test Port Name: port1.1.1
Mirror option: Enabled
Mirror direction: receive
Monitored Port Name: port1.1.3
Mirror Test Port Name: port1.1.1
Mirror option: Enabled
Mirror direction: transmit
Monitored Port Name: port1.1.4
```

show mirror interface

Use this command to display port mirroring configuration for a mirrored (monitored) switch port.

Syntax `show mirror interface <port>`

Parameter	Description
<code><port></code>	The monitored switch port to display information about.

Mode User Exec, Privileged Exec and Interface Configuration

Example To display port mirroring configuration for the `port1.0.4`, use the following commands:

```
awplus# configure terminal
awplus(config)# interface port1.0.4
awplus(config-if)# show mirror interface port1.0.4
```

Output Figure 15-7: Example output from the **show mirror interface** command

```
Mirror Test Port Name: port1.0.3
Mirror option: Enabled
Mirror direction: both
Monitored Port Name: port1.0.4
```

show platform

This command displays the settings configured using the platform commands.

Syntax `show platform`

Mode User Exec and Privileged Exec

Example To check the settings configured with platform commands on the switch, use the following command:

```
awplus# show platform
```

Output Figure 15-8: Example output from the `show platform` command

```
Control-plane-prioritization Max 60 Mbps
Jumboframe support          off
Enhanced mode                none
Vlan-stacking TPID          0x8100
```

Table 15-1: Parameters in the output of the `show platform` command

Parameter	Description
Control-plane-prioritization	Maximum traffic rate on the CPU port set using the <code>platform control-plane-prioritization rate</code> command.
Jumboframe support	Whether the jumbo frames setting is enabled or disabled.
Enhanced mode	Whether the memory is arranged to store QoS traffic class counters or in its default state. "qoscounters" indicates that it can store the counters, while "None" indicates that it is in its default state.
Vlan-stacking TPID	The value of the TPID set in the Ethernet type field when a frame has a double VLAN tag.

Related Commands

- `platform control-plane-prioritization rate`
- `platform enhancedmode`
- `platform jumboframe`
- `platform vlan-stacking-tpid`

show platform bist

This command displays the result of a previously run BIST (Built In Self Test) on the switch.

Syntax `show platform bist`

Mode Privileged Exec

Example To show the result of a previously run BIST on the switch, enter the following command:

```
awplus# show platform bist
```

Output Figure 15-9: Example output from the **show platform bist** command

```
Platform Built In Self Test Results
Switch Instance 0 ..... Passed
00  forward  static
```

Related Commands [platform bist](#)

show platform classifier statistics utilization brief

This command displays the total memory space, and free memory space of CAM (Content-Addressable Memory). Utilization statistics for various platform functions, such as ACLs and QoS are also shown.

Syntax `show platform classifier statistics utilization brief`

Mode Privileged Exec

Example To display the platform classifier utilization statistics, use the following command:

```
awplus# show platform classifier statistics utilization brief
```

Output Figure 15-10: Output from the `show platform classifier statistics utilization brief` command

```
[Instance 0]
[ port1.0.1-1.0.12]
----- Used / Total
DHCP Snooping      0
Web Auth           0
Loop Detection     0
EPSR               0
Global ACL         1
ACL                0
QoS                0
Total              1 / 1024 (0.10%)

Ext (IPv6) Number of PCE Entries:
----- Used / Total
MLD Snooping      0
IPv6 Global ACL   1
IPv6 ACL          0
Total             1 / 512 (0.20%)

Profiles:
Legend of Offset Type) 1:Ether 2:IP 3:TCP/UDP
Packet Type  Offset Type  Used / Total
----- 0-----8-----15 -----
TCP (IPv4)    2222000000000000    4 / 16
UDP (IPv4)    2222000000000000    4 / 16
IPv4 fragment 2222000000000000    4 / 16
IPv4 other    2222000000000000    4 / 16
Ethernet      0000000000000000    0 / 16
IPv6          2222220000000000    6 / 16
```

Figure 15-11: Output from the **show platform classifier statistics utilization brief** command (XEM-2XP)

```
[Instance 0]
 [ port1.1.1-1.1.2 ]
 Note: Each v6 classifier take two entries
       Used / Total
-----
MLD Snooping      0
DHCP Snooping     0
Web Auth          0
Loop Detection    0
EPSR              0
IPv6 Global ACL   2
IPv6 ACL          0
Global ACL        1
ACL               0
QoS               0
Total             3 / 8172 (0.00%)

Profiles:
Legend of Offset Type) 1:Ether 2:IP 3:TCP/UDP
Packet Type  Offset Type      Used / Total
----- 0-----8-----15 -----
TCP (IPv4)   2222220000000000    6 / 16
UDP (IPv4)   2222220000000000    6 / 16
IPv4 fragment 2222220000000000    6 / 16
IPv4 other   2222220000000000    6 / 16
Ethernet     0000000000000000    0 / 16
IPv6         2222220000000000    6 / 16
```

show platform counter ipv4

This command displays the IPv4 packet counters on the switch, first globally then by instance.

Syntax `show platform counter ipv4`

Mode User Exec and Privileged Exec

Example To display IPv4 packet counters for the switch, use the following command:

```
awplus# show platform counter ipv4
```

Output Figure 15-12: Example output from the `show platform counter ipv4` command

```

Ipv4 counters
-----
ip global receive packet ..... 0
ip global receive octet ..... 0
ip global discard packet ..... 0
ip global discard octet ..... 0

ip receive packet[1] ..... 0
ip receive octet[1] ..... 0
ip discard packet[1] ..... 0
ip discard octet[1] ..... 0
ip multicast packet[1] ..... 0
ip trap packet[1] ..... 0
ip failed packet[1] ..... 0

```

Table 15-2: Parameters in the output from the `show platform counter ipv4` command

Parameter	Description
<code>ip global receive packet</code>	Number of IPv4 packets received on the switch.
<code>ip global receive octet</code>	Number of IPv4 octets received on the switch.
<code>ip global discard packet</code>	Number of IPv4 packets discarded on the switch.
<code>ip receive packet <instance></code>	Number of IPv4 packets received on the instance.
<code>ip receive octet <instance></code>	Number of IPv4 octets received on the instance.
<code>ip discard octet <instance></code>	Number of IPv4 octets discarded on the instance.
<code>ip multicast packet <instance></code>	Number of IPv4 multicast packets on the instance.
<code>ip trap packet <instance></code>	Number of IPv4 packets trapped on the instance.
<code>ip failed packet <instance></code>	Number of failed IPv4 packets on the instance.

Related Commands `show platform port`

show platform full debug

This command displays low-level system information and diagnostics.

Note This command is provided for Allied Telesis support staff, and not intended for general use.



Syntax `show platform full-debug [<1-8>]`

Parameter	Description
<1-8>	The number of a specific stack member

Mode User Exec and Privileged Exec

Examples To show full platform debug information, use the following commands:

```
awplus# show platform full-debug
```

To show full platform debug information specifically for stack member 2 use the following command.

```
awplus# show platform full-debug 2
```

Related Commands [platform bist](#)

show platform port

This command displays the various port registers or platform counters for specified switchports.

Syntax `show platform port [<port-list>|counters]`

Parameter	Description
<code><port-list></code>	The ports to display information about. A port-list can be: <ul style="list-style-type: none"> ■ a continuous range of ports separated by a hyphen, e.g. <code>port1.0.1-1.0.24</code> or <code>port1.1.1-port1.1.24</code> ■ a comma-separated list of ports and port ranges, e.g. <code>port1.0.1,port1.1.1-1.2.24</code>
<code>counters</code>	show the platform counters

Mode User Exec and Privileged Exec

Examples To display port registers for `port1.0.1` and `port1.0.2` use the following command:

```
awplus# show platform port port1.0.1-port1.0.2
```

To display platform counters for `port1.0.1` and `port1.0.2` use the following command:

```
awplus# show platform port port1.0.1-port1.0.2 counters
```

Output Figure 15-13: Example output from the `show platform port` command

```
awplus#show platform port port1.1.1
Stack member 1
PHY Registers for ifx 5101 (lport 0x00000004)
 0 1140 1 796D 2 0141 3 0CD4 4 01E1 5 4501 6 0007 7 2801
 8 0000 9 0E00 10 4000 11 0000 12 0000 13 0000 14 0000 15 3000
16 0078 17 6D40 18 0000 19 1F40 20 0CEA 21 0001 22 0000 23 0000
24 4141 25 03A0 26 400A 27 848B 28 0000 29 0005 30 05AC 31 0000
Port configurations:
lport 4 macStatus: 0x01000804 value: 0x00002019
 macCtrl: 0x01000800 value: 0x11266619
 macCounters: 0x01010400 value: 0x00A07404
 portControl: 0x02004000 value: 0x0010C684
 portVid: 0x02004004 value: 0x00000001
 brdByteLimit: 0x02004008 value: 0xFFFF0000
 brdByteWindow: 0x0200400C value: 0x00FFFF00
 protoVidBased: 0x02004800 value: 0x20012001
 rxBufLimit: 0x03011010 value: 0x00001038
 flowCntrlThr: 0x03010010 value: 0xFA404001
```

Output Figure 15-14: Example output from the `show platform port counters` command

```

awplus#show platform port port1.1.1 counters

Stack member 1

Switch Port Counters
-----

Port 1.1.1 Ethernet MAC counters:
Combined receive/transmit packets by size (octets) counters:
 64                               58 512 - 1023                17
 65 - 127                         18246 1024 - MaxPktSz        415
 128 - 255                         200588
 256 - 511                          731

General Counters:
Receive                               Transmit
Octets          10544144711680 Octets          24004329
Pkts            50748 Pkts            169307
CRCErrors      0
UnicastPkts    0 UnicastPkts    0
MulticastPkts 50743 MulticastPkts  156914
BroadcastPkts 1 BroadcastPkts  10541
FlowCtrlFrms  0 FlowCtrlFrms   0
OversizePkts  0
Fragments     0
Jabbers       0
UpsupportOpco 0
UndersizePkts 0

                               Collisions          0
                               LateCollisions     0
                               ExcessivCollsns    0

Miscellaneous Counters:
MAC TxErr      0
MAC RxErr      0
Drop Events    0
    
```

Table 15-3: Output parameters from the **show platform port counters** command

Parameter	Description
Ethernet MAC counters	
Combined receive/transmit packets by size (octets) counters	Number of packets in each size range received and transmitted.
64	Number of 64 octet packets received and transmitted.
65 - 127	Number of 65 - 127 octet packets received and transmitted.
128 - 255	Number of 128 - 255 octet packets received and transmitted.
256 - 511	Number of 256 - 511 octet packets received and transmitted.
512 - 1023	Number of 512 - 1023 octet packets received and transmitted.
1024 - MaxPktSz	Number of packets received and transmitted with size 1024 octets to the maximum packet length.
General Counters	
Receive	Counters for traffic received.
Octets	Number of octets received.
Pkts	Number of packets received.
CRCErrors	Number of CRC (Cyclic Redundancy Check) error events received.
UnicastPkts	Number of unicast packets received.
MulticastPkts	Number of multicast packets received.
BroadcastPkts	Number of broadcast packets received.
FlowCtrlFrms	Number of good Flow Control frames received.
OversizePkts	Number of oversize packets received.
Fragments	Number of fragments received.
Jabbers	Number of jabber frames received.
UnsupportOpcode	Number of MAC Control frames with unsupported opcode received.
UndersizePkts	Number of undersized packets received.
Transmit	Counters for traffic transmitted.
Octets	Number of octets transmitted.
Pkts	Number of packets transmitted.
UnicastPkts	Number of unicast packets transmitted.
MulticastPkts	Number of multicast packets transmitted.
BroadcastPkts	Number of broadcast packets transmitted.
FlowCtrlFrms	Number of good Flow Control frames transmitted.
OversizePkts	Number of oversize packets transmitted.
FlowCtrlFrms	The number of Flow Control frames transmitted.
Collisions	Total number of collisions seen by the MAC.
LateCollisions	Total number of late collisions seen by the MAC.

Table 15-3: Output parameters from the `show platform port counters` command (cont.)

Parameter	Description
ExcessivCollsns	Number of frames dropped in the transmit MAC due to excessive collisions. This is applicable for Half-Duplex mode only.
Miscellaneous Counters	
Mac TxErr	Number of frames not transmitted correctly or dropped due to internal MAC transmit error.
Mac RxErr	Number of Receive Error events seen by the receive side of the MAC.
DropEvents	Number of instances that the port was unable to receive packets due to insufficient bandwidth to one of the PP internal resources, such as the DRAM or buffer allocation.

Related Commands [show platform counter ipv4](#)

show platform portstorm

This command displays the result of a previously run port storm test on the switch.

Syntax `show platform portstorm [full]`

Parameter	Description
full	Optional parameter to display the full result output

Mode Privileged Exec

Example To show the result of a previously run port storm on the switch, use the following command:

```
awplus# show platform portstorm
```

Related Commands [platform portstorm](#)

show platform prbs

This command displays the result of a previously run PRBS (Pseudo-Random Bit Stream) test on the switch.

Syntax `show platform prbs [full]`

Parameter	Description
full	Optional parameter to display the full result output

Mode Privileged Exec

Example To show the result of a previously run PRBS on the switch, use the following command:

```
awplus# show platform prbs
```

Related Commands [platform prbs](#)

show platform register

This command displays the platform registers.

Syntax `show platform register [(filter <string>) | bridgeRegs | bufferMng | egrTxQConf | extMemRegs | flowRegs | globalRegs | i2cReg | internalInlifTables | interrupts | ipv4Regs | ledRegs | macRegs | pclRegs | sdmaRegs | smiRegs | trafficClass] [instance {<0-127> | all}]`

Parameter	Description
<code>filter</code>	Only show registers whose name contain the text string <code><string></code> .
<code><string></code>	Specify the text string to match.
<code>bridgeRegs</code>	Set of bridge registers.
<code>bufferMng</code>	Set of buffer management registers.
<code>egrTxQConf</code>	Set of egress and transmit queue registers.
<code>extMemRegs</code>	Set of external memory registers.
<code>flowRegs</code>	Set of flow registers.
<code>globalRegs</code>	Set of global registers.
<code>i2cReg</code>	Set of two-wire serial interface (TWSI) registers.
<code>internalInlifTables</code>	Set of internal input logical interface registers.
<code>interrupts</code>	Set of interrupt registers.
<code>ipv4Regs</code>	Set of IPv4 registers.
<code>ledRegs</code>	Set of LED registers.
<code>macRegs</code>	Set of MAC registers.
<code>pclRegs</code>	Set of policy control list (PCL) registers.
<code>sdmaRegs</code>	Set of serial direct memory access (SDMA) registers.
<code>smiRegs</code>	Set of serial management interface (SMI) registers.
<code>trafficClass</code>	Set of traffic class registers.
<code>instance</code>	Chip instance.
<code><0-127></code>	Chip instance in the range 0 to 127.
<code>all</code>	All chip instances.

Mode User Exec and Privileged Exec

show platform swtable

This command displays the various software tables.

Syntax `show platform swtable [list|<name> [decode [verbosity {detailed|essential|everything}]] [index <start-index> <end-index>]] [instance {<0-127>|all}]`

Parameter	Description
list	Display all the available silicon table titles.
<name>	Specify the complete or partial title of the silicon table or tables to display.
decode	Display the column form in addition to raw hex form.
verbosity	Specify the amount of fields to show.
detailed	Display more than essential fields.
essential	Display essential fields.
everything	Display every field.
index	Display the specified silicon tables' entries between the following indexes.
<start-index>	Specify the starting index in the range 0 to 4294967295.
<end-index>	Specify the ending index in the range 0 to 4294967295.
instance	Chip instance.
<0-127>	Chip instance in the range 0 to 127.
all	All chip instances.

Mode User Exec and Privileged Exec

Example To display the QoSCheckTCAMShadow software table use the following command:

```
awplus# show platform swtable QoSCheckTCAMShadow
```

Output Figure 15-15: Example output from the `show platform swtable` command

```
awplus#show platform swtable QoSCheckTCAMShadow
Software table QoSCheckTCAMShadow on instance 0

Standard Entries : 1 / 1024 (0.10%)
Extended Entries : 1 / 512 (0.20%)
Pcl-Id 127:      2 entries. In order:Yes
```

Figure 15-16: Example output from the **show platform swtable** command (XEM-2XP)

```
awplus#show platform swtable QosCheckTCAMShadow
Software table QosCheckTCAMShadow on instance 0

Percentage full : 0.04% ( 3 / 8192 )
Pcl-Id 127:      2 entries. In order:Yes
```

show platform table

This command displays the software and silicon composite tables.

Syntax `show platform table [e2efc|ip|ipmulti|ipv6|ipv6multi|macaddr|mclinklist|mcv6linklist|xbarroutes] [instance {<0-127>|all}]`

Parameter	Description
e2efc	End-to-End Flow Control scoreboard.
ip	IP table.
ipmulti	IP multicast table.
ipv6	IPv6 table.
ipv6multi	IPv6 multicast table.
macaddr	MAC address table.
mclinklist	IP multicast linked list table.
mcv6linklist	IPv6 multicast linked list table.
xbarroutes	Xbar's routes.
instance	Chip instance.
<0-127>	Chip instance in the range 0 to 127.
all	All chip instances.

Mode User Exec and Privileged Exec

show port-security interface

Shows the current configuration and the switch port status.

Syntax `show port-security interface <port>`

Parameter	Description
<port>	The port to display information about. The port may be a switch port (e.g. <code>port1.1.4</code>), a static channel group (e.g. <code>sa3</code>), or a dynamic (LACP) channel group (e.g. <code>po4</code>).

Mode User Exec and Privileged Exec

Example To see the port-security status on `port1.0.1`, use the following command:

```
awplus# show port-security interface port1.0.1
```

Output Figure 15-17: Example output from the `show port-security interface` command for port 1.0.1

```
Port Security configuration
Security Enabled           : YES
Port Status               : ENABLED
Violation Mode            : TRAP
Aging                     : OFF
Maximum MAC Addresses     : 3
Current Learned Addresses : 1
Lock Status               : UNLOCKED
Security Violation Count  : 0
Last Violation Source Address: None
```

show port-security intrusion

Shows the intrusion list. If the port is not give, entire intrusion table is shown.

Syntax `show port-security intrusion [interface <port>]`

Parameter	Description
interface	Specify a port
<port>	The port to display information about. The port may be a switch port (e.g. <code>port1.1.4</code>), a static channel group (e.g. <code>sa3</code>), or a dynamic (LACP) channel group (e.g. <code>po4</code>).

Mode User Exec and Privileged Exec

Example To see the intrusion list on `port1.0.1`, use the following command:

```
awplus# show port-security intrusion interface port1.0.1
```

Output Figure 15-18: Example output from the `show port-security intrusion` command for port 1.0.1

```
Port Security Intrusion List
Interface: port1.0.1 -3 intrusion(s) detected
11-22-33-44-55-04 11-22-33-44-55-06 11-22-33-44-55-08
```

show provisioning (xem-bay)

This command shows the provisioning status of all installed or provisioned hardware. Provisioning is the preconfiguration necessary to accommodate future connection of hardware items such as a XEM bay.

Syntax `show provisioning`

Mode Privileged Exec

Example To show provisioning, use the following command:

```
awplus# show provisioning
```

Output Figure 15-19: Sample output from the `show provisioning` command

```
Switch provisioning summary information

ID Board class Status
1.0 x600-24      Hardware present
2.0 x600-24      Hardware present
3.0 x600-48      Hardware present
4.0 x600-24      Provisioned

awplus#show provisioning
Switch provisioning summary information

ID Board class Status
1.0 x908         Hardware present
1.1 xem-12       Provisioned
1.4 xem-2        Hardware present
1.5 xem-1        Provisioned
```

Table 15-4: Terms used in the `show provisioning` command output

Parameter	Meaning
ID	The unit.bay-location of the hardware provision.
Board class	The hardware type.
Status	The provisioned state: <ul style="list-style-type: none"> ■ Hardware Present means that the hardware is currently installed in the stack or switch. ■ Provisioned means that although the hardware is not currently installed; the stack, or bay, is preconfigured ready to accept the hardware installation.

Related Commands `show stack`

show storm-control

Use this command to display storm-control information for all interfaces or a particular interface.

Syntax `show storm-control [<port>]`

Parameter	Description
<port>	The port to display information about. The port may be a switch port (e.g. port1.1.4), a static channel group (e.g. sa3), or a dynamic (LACP) channel group (e.g. po4).

Mode User Exec and Privileged Exec

Example To display storm-control information for port1.0.2, use the following command:

```
awplus# show storm-control port1.0.2
```

Output Figure 15-20: Example output from the **show storm-control** command for port1.0.2

Port	BcastLevel	McastLevel	DlfLevel
port1.1.2	40.0%	100.0%	100.0%

Example To display storm-control information for all ports, use the following command:

```
awplus# show storm-control
```

Output Figure 15-21: Example output from the **show storm-control** command for all ports

```
awplus#show storm-control
Port          BcastLevel  McastLevel  DlfLevel
port1.0.1     100.0%     100.0%     100.0%
port1.0.2     100.0%     100.0%     100.0%
port1.0.3     100.0%     100.0%     100.0%
port1.0.4     100.0%     100.0%     100.0%
port1.0.5     100.0%     100.0%     100.0%
port1.0.6     100.0%     100.0%     100.0%
port1.0.7     100.0%     100.0%     100.0%
port1.0.8     100.0%     100.0%     100.0%
port1.0.9     100.0%     100.0%     100.0%
port1.0.10    100.0%     100.0%     100.0%
port1.0.11    100.0%     100.0%     100.0%
port1.0.12    100.0%     100.0%     100.0%
port1.0.13    100.0%     100.0%     100.0%
port1.0.14    100.0%     100.0%     100.0%
port1.0.15    100.0%     100.0%     100.0%
port1.0.16    100.0%     100.0%     100.0%
port1.0.17    100.0%     100.0%     100.0%
port1.0.18    100.0%     100.0%     100.0%
port1.0.19    100.0%     100.0%     100.0%
port1.0.20    100.0%     100.0%     100.0%
port1.0.21    100.0%     100.0%     100.0%
port1.0.22    100.0%     100.0%     100.0%
port1.0.23    100.0%     100.0%     100.0%
port1.0.24    100.0%     100.0%     100.0%
```

Related Commands [storm-control level](#)

speed

This command changes the speed of the specified port. You can optionally specify the speed or speeds that get autonegotiated, so autonegotiation is only attempted at the specified speeds.

To see the currently-negotiated speed for ports whose links are up, use the command [show interface](#). To see the configured speed (when different from the default), use the command [show running-config](#).

Syntax `speed {10|100|1000|10000|auto [10] [100] [1000] [10000]}`

The following table shows the speed options for each type of port.

Port type	Speed Options (units are Mbps)
non-SFP RJ-45 copper ports	auto (default) 10 100 1000
supported tri-speed copper SFPs	auto (default) 10 100 1000
100Mb fibre SFPs	100
1000Mb fibre SFPs	auto (default) 1000
XFP modules	auto (default) 10000 Note that XFG is fixed speed and runs at 10G. For example, XFG cannot be stepped down to run at the same port speed as a 1G SFP.

Mode Interface Configuration

Default By default, ports auto-negotiate speed (except for 100Base-FX ports which do not support auto-negotiation, so default to 100Mbps).

Usage Switch ports in a static or dynamic (LACP) channel group must have the same port speed and be in full duplex mode. Once switch ports have been aggregated into a channel group, you can set the speed of all the switch ports in the channel group by applying this command to the channel group.

Note  Note that if multiple speeds are specified after the auto option to autonegotiate speeds, then only those speeds specified are attempted for autonegotiation.

Examples To set the speed of a tri-speed port to 100Mbps, enter the following commands:

```
awplus# configure terminal
awplus(config)# interface port1.0.4
awplus(config-if)# speed 100
```

To return the port to auto-negotiating its speed, enter the following commands:

```
awplus# configure terminal
awplus(config)# interface port1.0.4
awplus(config-if)# speed auto
```

To set a port to auto-negotiate its speed at 100Mbps and 1000Mbps, enter the following commands:

```
awplus# configure terminal
awplus(config)# interface port1.0.2
awplus(config-if)# speed auto 100 1000
```

To set a port to auto-negotiate its speed at 1000Mbps only, enter the following commands:

```
awplus# configure terminal
awplus(config)# interface port1.0.2
awplus(config-if)# speed auto 1000
```

Related Commands duplex
show interface
speed (async)

storm-control level

Use this command to specify the threshold level for broadcasting, multicast, or destination lookup failure (DLF) traffic for the port. Storm-control limits the specified traffic type to the specified threshold.

Use the **no** variant of this command to disable storm-control for broadcast, multicast or DLF traffic.

Syntax `storm-control {broadcast|multicast|dlf} level <level>`
`no storm-control {broadcast|multicast|dlf} level`

Parameter	Description
<level>	<0-100> Specifies the threshold as a percentage of the maximum port speed.
broadcast	Applies the storm-control to broadcast frames.
multicast	Applies the storm-control to multicast frames.
dlf	Applies the storm-control to destination lookup failure traffic.

Default By default, storm-control is disabled.

Mode Interface Configuration

Usage Flooding techniques are used to block the forwarding of unnecessary flooded traffic. A packet storm occurs when a large number of broadcast packets are received on a port. Forwarding these packets can cause the network to slow down or time out.

Example To limit broadcast traffic on `port1.0.2` to 30% of the maximum port speed, use the following commands:

```
awplus# configure terminal
awplus(config)# interface port1.0.2
awplus(config-if)# storm-control broadcast level 30
```

Related Commands `show storm-control`

switch bay provision

This command enables you to pre configure a specific empty bay within a switch ready for inserting a particular XEM type. To run this command, the bay position must be vacant and the selected XEM type must be one that is currently supported.

Use the **no** variant of this command to remove an existing switch provision.

Syntax `switch <1-8> bay <1-8> {provision|reprovision} {xem-1|xem-2|xem-12}`
`no switch <1-8> bay <1-8> provision`

Parameter	Description
<code>switch <1-8></code>	The stack member switch position to be either provisioned or reprovisioned
<code>bay <1-8></code>	The switch bay to be either provisioned or reprovisioned.
<code>provision</code>	Provides settings within the switch configuration ready for a specific XEM to be inserted into a specific bay.
<code>reprovision</code>	Reconfigure an existing provision switch bay configuration

Mode Global Configuration

Examples To provision a 12 port XEM in bay 1 of stack member 2, use the following commands:

```
awplus# configure terminal
awplus(config)# switch 2 bay 1 provision xem-12
```

To change the provisioning of the XEM bay to accommodate a 2 port XEM, use the following commands:

```
awplus# configure terminal
awplus(config)# switch 2 bay 1 reprovision xem-2
```

To remove the above provisioning, use the following commands:

```
awplus# configure terminal
awplus(config)# no switch 2 bay 1 provision
```

Related Commands [show provisioning \(xem-bay\)](#)

switchport port-security

Enables the port-security feature. This feature is also known as port-based learn limit. It allows the user to set the maximum number of MAC addresses that each port can learn.

Use the **no** variant of this command to disable the port-security feature.

Syntax `switchport port-security`
`no switchport port-security`

Mode Interface Configuration

Examples To enable the port-security feature on `port1.0.4`, use the following commands:

```
awplus# configure terminal
awplus(config)# interface port1.0.4
awplus(config-if)# switchport port-security
```

To disable port-security feature on `port1.0.4`, use the following commands:

```
awplus# configure terminal
awplus(config)# interface port1.0.4
awplus(config-if)# no switchport port-security
```

switchport port-security aging

Sets the port-security MAC to time out.

Use the **no** variant of this command to set the port-security to not time out.

Syntax `switchport port-security aging`
`no switchport port-security aging`

Mode Interface Configuration

Examples To set the MAC to time out, use the following command:

```
awplus# switchport port-security aging
```

To unset the MAC time out, use the following command:

```
awplus# no switchport port-security aging
```

switchport port-security maximum

Sets the maximum MAC address that each port can learn.

Use the **no** variant of this command to unset the maximum number of MAC addresses that each port can learn. This is same as setting the maximum number to 0. This command also resets the intrusion list table.

Syntax `switchport port-security maximum <0-256>`
`no switchport port-security maximum`

Parameter	Description
<code>maximum</code>	Maximum number of address to learn
<code><0-256></code>	Maximum number of address to learn

Mode Interface Configuration

Examples To learn 3 MAC addresses on `port1.0.4`, use the following commands:

```
awplus# configure terminal
awplus(config)# interface port1.0.4
awplus(config-if)# switchport port-security maximum 3
```

To remove the MAC learning limit on `port1.0.4`, use the following commands:

```
awplus# configure terminal
awplus(config)# interface port1.0.4
awplus(config-if)# no switchport port-security maximum
```

switchport port-security violation

Sets the violation action for a switch port when the port exceeds the learning limits. The port action can be either **shutdown**, **restrict** or **protect**. If **shutdown** is set, the physical link will be disabled and "shutdown" will be shown in the config. If **restrict** is set, the packet from the unauthorized MAC will be discarded and SNMP TRAP will be generated to alert management. If **protect** is set, the packet will simply be discarded by the packet processor silently.

The **no** variant of this command sets the violation action to default. The default violation action is protect.

Syntax `switchport port-security violation {shutdown|restrict|protect}`
`no switchport port-security violation`

Parameter	Description
<code>shutdown</code>	Disable the port
<code>restrict</code>	Alert the network administrator
<code>protect</code>	Discard the packet

Mode Interface Configuration

Examples To set the action to be shutdown on `port1.0.4`, use the following commands:

```
awplus# configure terminal
awplus(config)# interface port1.0.4
awplus(config-if)# switchport port-security violation shutdown
```

To set the port-security action to the default (protect) on `port1.0.4`, use the following commands:

```
awplus# configure terminal
awplus(config)# interface port1.0.4
awplus(config-if)# no switchport port-security violation
```

thrash-limiting

Sets and configures the thrash limit action that will be applied to any port on the switch when a thrashing condition is detected. The thrash-limiting timeout specifies the time, in seconds, for which the thrash action is employed.

Syntax `thrash-limiting {[action {learn-disable|link-down|port-disable|vlan-disable|none}] [timeout <0-86400>]}`
`no thrash-limiting {action|timeout}`

Parameter	Description
<code>action</code>	The mac thrashing detected action. The default is <code>vlan-disable</code> .
<code>learn-disable</code>	Disable mac address learning
<code>link-down</code>	Block all traffic on an interface - link down
<code>port-disable</code>	Block all traffic on an interface - link remains up
<code>vlan-disable</code>	Block all traffic on a vlan Note that setting this parameter will also enable ingress filtering.
<code>none</code>	No thrash action
<code>timeout</code>	Set the duration for the thrash action
<code><0-86400></code>	The duration of the applied thrash action in seconds. The default is 1 seconds.

Default The default action is `vlan-disable`.

Mode Interface Mode

Examples To set the action to learn disable for `port1.0.4`, use the following commands:

```
awplus# configure terminal
awplus(config)# interface port1.0.2
awplus(config-if)# thrash-limiting action learn-disable
```

To set the thrash limiting timeout to 5 seconds, use the following command:

```
awplus(config-if)# thrash-limiting timeout 5
```

To set the thrash limiting action to its default, use the following command:

```
awplus(config-if)# no thrash-limiting action
```

To set the thrash limiting timeout to its default, use the following command:

```
awplus(config-if)# no thrash-limiting timeout
```

undebug platform packet

This command applies the functionality of the [no debug platform packet](#) command on page 15.7.

undebug loopprot

This command applies the functionality of the [no debug loopprot](#) command on page 15.6.

Chapter 16: VLAN Introduction



Introduction.....	16.2
Virtual LANs (VLANs).....	16.2
Configuring VLANs.....	16.3
VLAN Double Tagging (VLAN Stacking)	16.5
How Double-Tagged VLANs Work.....	16.5
VLAN Rules for Double Tagging.....	16.5
Restrictions when using Double-Tagged VLANs.....	16.6
Configuring Double-Tagged VLANs.....	16.6
Private VLANs.....	16.8
Membership Rules.....	16.8
Promiscuous Ports.....	16.9
Host Ports.....	16.9
Private VLAN Operation.....	16.10
Example Configuration.....	16.11

Introduction

This chapter describes Virtual LANs (VLAN), VLAN features and configuration on the switch. For detailed descriptions of commands used to configure VLANs, see [Chapter 17, VLAN Commands](#). For information about Voice VLAN and LLDP-MED, see [Chapter 80, LLDP Introduction](#).

Virtual LANs (VLANs)

A Virtual LAN (VLAN) is a logical, software-defined subnetwork. It allows similar devices on the network to be grouped together into one broadcast domain, irrespective of their physical position in the network. Multiple VLANs can be used to group workstations, servers, and other network equipment connected to the switch, according to similar data and security requirements.

Decoupling logical broadcast domains from the physical wiring topology offers several advantages, including the ability to:

- Move devices and people with minimal, or no, reconfiguration
- Change a device's broadcast domain and access to resources without physically moving the device, by software reconfiguration or by moving its cable from one switch port to another
- Isolate parts of the network from other parts, by placing them in different VLANs
- Share servers and other network resources without losing data isolation or security
- Direct broadcast traffic to only those devices which need to receive it, to reduce traffic across the network
- Connect 802.1Q-compatible switches together through one port on each switch

Devices that are members of the same VLAN only exchange data with each other through the switch's layer 2 switching capabilities. To exchange data between devices that are located in different VLANs, the switch's layer 3 (routing) capabilities are used. The switch passes VLAN status information to the Internet Protocol (IP) module that indicates whether a VLAN is up or down. This information is used to determine route availability.

The device supports up to 4094 VLANs (the maximum allowed by the VID field in the 802.1Q tag). On some devices a few of these VLANs may be reserved for management purposes. When the switch is first powered up (and therefore unconfigured), it creates a default VLAN with a VID of 1 and an interface name of *vlan1*. In this initial condition, the switch attaches all its ports to this default VLAN. The default VLAN cannot be deleted, and ports can only be removed from it if they also belong to at least one other VLAN. If all the devices on the physical LAN belong to the same logical LAN, that is, the same broadcast domain, then the default settings will be acceptable, and no additional VLAN configuration is required.

Configuring VLANs

Defaults By default, all switch ports are in access mode, are associated with the default VLAN (*vlan1*), and have ingress filtering on. You cannot delete *vlan1*.

VLAN names When you create a VLAN ([vlan command on page 17.22](#)), you give it a numerical VLAN Identifier (VID)—a number from 2 to 4094, which is included in VLAN-tagged Ethernet frames to and from this VLAN. You may also give it an arbitrary alphanumeric name containing a meaningful description, which is not transmitted to other devices.

When referring to a VLAN, some commands require the VLAN to be specified by its VID while some commands require it to be specified by its interface name: *vlan<VID>*. In command output, the VLAN may be referred to by its VID, its interface name (*vlan<VID>*), or its VLAN name (the arbitrary alphanumeric string).

You can name a VLAN with a string containing "vlan" and its VLAN Identifier (VID). To avoid confusion, we recommend not naming it "vlan" followed by any number different from its VID.

Access mode A switch port in access mode sends untagged Ethernet frames, that is, frames without a VLAN tag. Each port is associated with one VLAN (the port-based VLAN, by default, *vlan1*), and when it receives untagged frames, it associates them with the VID of this VLAN. You can associate the port with another VLAN created by the *vlan* command, and this removes it from the default VLAN ([switchport access vlan](#) command).

Use access mode for any ports connected to devices that do not use VLAN tagging, for instance PC workstations.

Trunk mode A switch port in trunk mode is associated with one or more VLANs for which it transmits VLAN-tagged frames, and for which it identifies incoming tagged frames with these VIDs.

To allow a switch port to distinguish and identify traffic from different VLANs, put it in trunk mode ([switchport mode trunk](#)), and add the VLANs ([switchport trunk allowed vlan](#)). Use trunk mode for ports connected to other switches which send VLAN-tagged traffic from one or more VLANs.

A trunk mode port may also have a *native* VLAN (by default *vlan1*), for which it transmits untagged frames, and with which it associates incoming untagged frames ([switchport trunk native vlan](#)).

Mirror ports A mirror port cannot be associated with a VLAN. If a switch port is configured to be a mirror port ([mirror interface command on page 15.17](#)), it is automatically removed from any VLAN it was associated with.

VLANs and channel groups All the ports in a channel group must have the same VLAN configuration: they must belong to the same VLANs and have the same tagging status, and can only be operated on as a group.

Table 16-1: Configuration procedure for VLANs

Create VLANs

<code>awplus# configure terminal</code>	Enter Configuration mode.
<code>awplus(config)# vlan database</code>	Enter VLAN Database Configuration mode.
<code>awplus(config-vlan)# vlan <vid> [name <vlan-name>] [state {enable disable}] or vlan <vid-range> [state {enable disable}]</code>	Create VLANs.

Associate switch ports with VLANs

<code>awplus(config-vlan)# interface <port-list></code>	Associate switch ports in access mode with VLANs:
<code>awplus(config-if)# switchport access vlan <vlan-id></code>	<ul style="list-style-type: none"> ■ Enter Interface Configuration mode for the switch ports that will be in access mode for a particular VLAN. ■ Associate the VLAN with these ports in access mode. Repeat for other VLANs and ports in access mode.
<code>awplus(config-if)# interface <port-list></code>	Associate switch ports in trunk mode with VLANs.
<code>awplus(config-if)# switchport mode trunk [ingress-filter {enable disable}]</code>	Enter Interface Configuration mode for all the switch ports that will be in trunk mode for a particular set of VLAN. Set these switch ports to trunk mode.
<code>awplus(config-if)# switchport trunk allowed vlan all or switchport trunk allowed vlan add <vid-list></code>	Allow these switch ports to trunk this set of VLANs.
<code>awplus(config-if)# switchport trunk native vlan {<vid> none}</code>	By default, a trunk mode switch port's native VLAN—the VLAN that the port uses for untagged packets—is VLAN 1. Some control packets are untagged, including MSTP CIST BPDUs. If required, change the native VLAN from the default. The new native VLAN must already be allowed for this switch port.
<code>awplus(config-if)# exit</code>	Return to Global Configuration mode.
<code>awplus(config)# exit</code>	Return to Privileged Exec mode.
<code>awplus# show vlan {all brief dynamic static}<1-4094></code>	Confirm VLAN configuration

VLAN Double Tagging (VLAN Stacking)

VLAN double tagging, also known as VLAN Stacking, Nested VLANs, or Q-in-Q VLANs, are used to operate a number of private Layer 2 networks within a single public Layer 2 network. This feature provides simple access infrastructure for network service providers to operate Metropolitan Area Networks (MANs) as commercial value added networks.

A nested VLAN implementation consists of the following port types:

- Provider ports - these connect to a service provider's Layer-2 network
- Customer edge ports - these connect to a customer's private Layer-2 network

How Double-Tagged VLANs Work

In a nested VLAN environment VLAN tagging exists at two levels:

- client tagging,
- service provider tagging.

When nested VLAN functionality is enabled, the service provider assigns to each of its clients, an individual 12 bit customer VID called an S-Tag. The S-Tag field has an identical structure to a conventional VLAN tag field.

The S-Tag is attached to a packet as it enters the service provider network at the customer edge port, and is removed as it leaves the destination customer edge port. From this point on, the S-Tag is used for transmission within the service provider, or public Layer-2, network. The VID that is used within the client's own network (now termed the C-Tag) is ignored by the service provider network and bridging is based on the value of the S-Tag. The ethernet type of the S-Tag is set by changing the Tag Protocol Identifier (TPID).

Once the S-Tag is removed from the packet, it is forwarded "as is" out of the customer-edge port. The tagged status of the Customer port is ignored on egress.

VLAN Rules for Double Tagging

When double-tagged VLANs are created on the switch:

- a nested VLAN belongs to only one customer and can have multiple customer-edge ports
- a port must be either a customer-edge port or a provider port, but cannot be both

A service provider port:

- accepts only tagged packets
- transmits only tagged packets
- can be in many double-tagged VLANs

A customer edge port:

- accepts both tagged and untagged packets
- transmits both tagged and untagged packets
- can be a member of only one nested VLAN

Restrictions when using Double-Tagged VLANs

Restrictions when double-tagged VLANs are implemented are:

- Ethernet bridging is based on the S-Tag VID instead of the packet C-Tag VID. The packets C-Tag VID does not change
- ARP packet trapping is restricted.
- hardware filtering does not work above MAC address level

Configuring Double-Tagged VLANs

You need a special feature license to use double-tagged VLANs. Contact your authorized Allied Telesis distributor or reseller for more information.

Turn on Jumbo frame support

Adding the S-Tag can result in frame sizes that exceed the maximum of 1522 bytes. In order to cope with these larger than normal frames, you should turn on Jumbo packet support on all devices running within the service provider network.

```
awplus# configure terminal
awplus(config)# platform jumboframe
```

Use the following command to reboot the device to enable the Jumbo frame support:

```
awplus# reboot
```

To create the VLANs to be nested

Step 1: Create, and enable, service provider VLANs 10 and 20.

```
awplus# configure terminal
awplus(config)# vlan database
awplus(config-vlan)# vlan 10, 20 state enable
```

Step 2: Configure ports 1.0.1 and 102 as a provider-port members of VLAN 10 and 20.

```
awplus# configure terminal
awplus(config)# interface port port1.0.1-port1.0.2
awplus(config)# switchport mode trunk
awplus(config)# switchport trunk allowed vlan add 10
awplus(config)# switchport trunk allowed vlan add 20
awplus(config-if)# switchport vlan-stacking provider-port
```

Step 3: Configure port 1.0.3 as a customer edge port member of VLAN 10.

```
awplus# configure terminal
awplus(config)# interface port port1.0.3
awplus(config)# switchport mode access
awplus(config)# switchport access vlan 10
awplus(config-if)# switchport vlan-stacking customer-edge-port
```

Step 4: Configure port 1.0.4 as a customer edge port member of VLAN 20.

```
awplus# configure terminal
awplus(config)# interface port port1.0.4
awplus(config)# switchport mode access
awplus(config)# switchport access vlan 20
awplus(config-if)# switchport vlan-stacking customer-edge-port
```

Step 5: Set the Tag Protocol Identifier (TPID).

If you need to change the Tag Protocol Identifier (TPID) from its default (for VLAN stacking) of 0x8100 (specified as hex notation), use the following command. This example changes the TPID to 0x9100:

```
awplus(config)# platform vlan-stacking-tpid 9100
```

The **nestedtpid** parameter specifies the Ethernet type of the tagged packet. This is set to 0x8100 by default.

Note that this command specifies the TPID value that applies to all VLANs used for double-tagged VLANs (stacked VLANs). You cannot set individual TPID values for different VLANs within a multi double tagged VLAN network.

Private VLANs

Private VLANs combine the network advantages of conventional VLANs, with an added degree of privacy obtained by limiting the connectivity between selected ports.

An example application of a private VLAN would be a library in which user booths each have a PC with Internet access. In this situation it would usually be undesirable to allow communication between these individual PCs. Connecting the PC to ports within a private isolated VLAN would enable each PC to access the Internet or a library server via a single connection, whilst preventing access between the PCs in the booths.

Another application might be to use private VLANs to simplify IP address assignment. Ports can be isolated from each other whilst still belonging to the same subnet.

A private VLAN comprises the following components:

- **a single promiscuous port** (sometimes called an uplink port)
- **one or more host ports** (sometimes called private ports)
There are two types of host ports:
 - « **isolated ports**
These can only communicate with the promiscuous port that is associated with the isolated VLAN.
 - « **community ports**
These can communicate with their associated promiscuous port and other community ports within the community VLAN.
- **a single primary VLAN**
- **one or more secondary VLANs**
There are two types of secondary VLANs:
 - « **isolated VLANs** (
In this VLAN type, communication can only take place between each host port and its associated promiscuous port.
 - « **community VLANs**
In this VLAN type, communication can take place between host ports and between each host port and its associated promiscuous port.

Membership Rules

The following membership rules apply when creating and operating private VLANs

Each private VLAN:

- must contain one promiscuous port or (aggregated link)
- may contain multiple host ports
- can be configured to span switch instances
- can only contain either promiscuous or host ports.
- cannot use the default VLAN (vlan1)
- a private *isolated* VLAN can only contain a single promiscuous port
- a private *community* VLAN can contain more than one promiscuous port

A host port:

- can be a member of multiple private (community) VLANs, but all these VLANs must share the same promiscuous port
- cannot be a host port in some VLANs and a non-host port in others
- cannot be a promiscuous port in another VLAN

A promiscuous port:

- is a member of the primary VLAN and all its associated secondary VLANs
- cannot be a member of both private and non-private VLANs

A private or promiscuous port:

- may use any VLAN classification rule (port, subnet, or protocol)

Promiscuous Ports

A promiscuous port can communicate with all ports that are members of its associated secondary VLANs. Multiple promiscuous ports can exist in a primary VLAN, but only if the primary VLAN is only associated with community VLANs (that is, that there are no isolated VLANs associated with this port).

A promiscuous port is a member of the primary VLAN and all associated secondary VLANs. Its Port VID is set to the VLAN ID of the primary VLAN.

Host Ports

Host ports have two levels of connectivity depending on whether they exist in an isolated or a community VLAN.

Host ports within an isolated VLAN

These ports are only allowed to communicate with their VLAN's promiscuous port, even though they share their secondary (isolated) VLAN with other hosts. The host ports receive their data from the promiscuous port via the primary VLAN, and *individually* transmit their data to the promiscuous port via their common secondary VLAN.

Host ports within a community VLAN

These ports are able to communicate with both the promiscuous port and the other ports within the community VLAN that they are associated with. They receive their data from the promiscuous port via the primary VLAN, and transmit their data to both the promiscuous port and the other host ports (within their community VLAN) via their common secondary VLAN. However, the only external path from a community VLAN is from its promiscuous port.

Private VLAN Operation

A basic private VLAN operation is shown in [Figure 16-1](#). It comprises primary VLAN 20 plus three secondary VLANs, two community VLANs 21 and 22, and an isolated VLAN 23.

Figure 16-1: Private VLAN

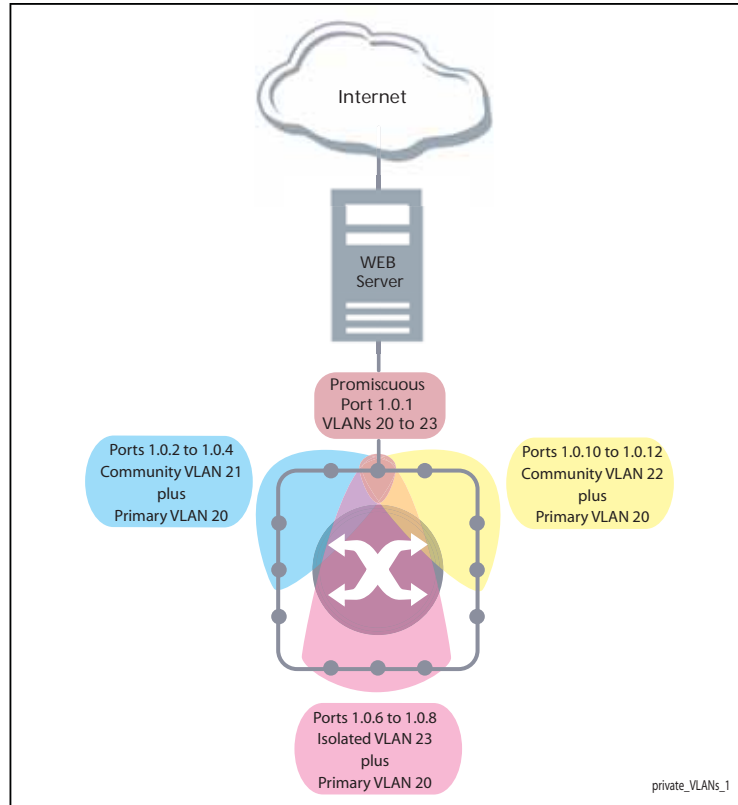

The ports on this switch have the following configuration:

- Port 1.0.1 is the promiscuous port and is a member of the primary VLAN 20 and all its associated secondary VLANs.
- Ports 1.0.1 to 1.0.4 are members of the community VLAN 21 and are able to communicate with both the promiscuous port and all other ports in VLAN 21.
- Ports 1.0.10 to 1.0.12 are members of the community VLAN 22 and are able to communicate with both the promiscuous port and all other ports in VLAN 22.
- Ports 1.0.6 to 1.0.8 are members of the isolated VLAN 23. Each of these ports can only communicate with the promiscuous port.

Table 16-2: Private VLANs - Port Tagging

Port	Mode	Untagged VLAN Membership	PVID
1.0.1	Promiscuous	20, 21, 22, 23	20
1.0.2 to 1.0.4	Host	20, 21	21
1.0.10 to 1.0.12	Host	20, 22	22
1.0.6 to 1.0.8	Host	20, 23	23
1.0.5	Not members of the private VLAN		-
1.0.9	Not members of the private VLAN		-

Private VLANs operate within a single switch and comprise one primary VLAN plus a number of secondary VLANs. All data enters the private VLAN ports untagged. Using the example of figure [Figure 16-1](#), data enters the switch via the promiscuous port 1.0.1 and is forwarded to the host ports using VLAN 20, the primary VLAN. Data returning from the host ports to the promiscuous port (and exiting the switch) use the secondary VLAN associated with its particular host port, VLAN 21, 22, or 23 in the example. Thus the data flows into the switch via the primary VLAN and out of the switch via the secondary VLANs. This situation is not detected outside of the switch, because all its private ports are untagged. Note however, that data flowing between ports within the same community VLAN will do so using the VID of the community VLAN.

Portfast on Private VLANs

Within private VLANs, we recommend that you place all host ports into spanning-tree portfast mode and enable BPDU guard. Portfast assumes that because host ports will also be edge ports, they will have no alternative paths (loops) via other bridges. These ports are therefore allowed to move directly from the spanning-tree blocking state into the forwarding state, thus bypassing the intermediate states.

Applying BPDU guard is an extra precaution. This feature disables an edge port if it receives a BPDU frame, because receiving such a frame would indicate that the port has a connection to another network bridge.

For more information on BPDU guard and portfast, see their following commands:

- [spanning-tree portfast bpd-filter command on page 19.45](#)
[spanning-tree portfast \(STP\) command on page 19.43](#)

Example Configuration

Step 1: Create the private VLANs

Create the four VLANs 20 to 23.

```
awplus# configure terminal
awplus(config)# vlan database
awplus(config-vlan)# vlan 20-23
```

Step 2: Set the private VLAN types

Set the VLANs to be private and either primary, community, or isolated.

```
awplus(config-vlan)# private-vlan 20 primary
awplus(config-vlan)# private-vlan 21 community
awplus(config-vlan)# private-vlan 22 community
awplus(config-vlan)# private-vlan 23 isolated
```

Step 3: Associate the secondary VLANs with the primary VLAN

```
awplus(config-vlan)# private-vlan 20 association add 21
awplus(config-vlan)# private-vlan 20 association add 22
awplus(config-vlan)# private-vlan 20 association add 23
```

Step 4: Set port 1.0.1 to be the promiscuous port.

Note that you must first return to the (config)# prompt.

```
awplus(config-vlan)# exit
awplus(config)# interface port1.0.1
awplus(config-if)# switchport mode private-vlan promiscuous
```

Step 5: Set the other ports to be host ports

```
awplus(config)# interface port1.0.2-1.0.4, port1.0.6-1.0.8,
port1.0.10-1.0.12
awplus(config-if)# switchport mode private-vlan host
```

Step 6: On the promiscuous port, map the primary VLAN to each of the secondary VLANs

Note that you must first return to the (config)# prompt.

```
awplus(config-vlan)# exit
awplus(config)# interface port1.0.1
awplus(config-if)# switchport private-vlan mapping 20 add 21
awplus(config-if)# switchport private-vlan mapping 20 add 22
awplus(config-if)# switchport private-vlan mapping 20 add 23
```

Step 7: Associate the community host ports with the community VLANs

Note that you must first return to the (config)# prompt.

```
awplus(config)# interface port1.0.2-1.0.4
awplus(config-if)# switchport private-vlan host-association 20
add 21
```

Associate the community host ports with the community VLAN 22.

```
awplus(config)# interface port1.0.10-1.0.12
awplus(config-if)# switchport private-vlan host-association 20
add 22
```

Step 8: Associate the isolated host ports with the isolated VLAN 23.

```
awplus(config)# interface port1.0.6-1.0.8
awplus(config-if)# switchport private-vlan host-association 20
add 23
```

Chapter 17: VLAN Commands



Command List	17.2
private-vlan	17.2
private-vlan association	17.3
show vlan	17.4
show vlan classifier group	17.5
show vlan classifier interface group	17.5
show vlan classifier rule	17.6
show vlan private-vlan	17.6
switchport access vlan	17.7
switchport enable vlan	17.8
switchport mode access	17.9
switchport mode private-vlan	17.10
switchport mode trunk	17.11
switchport private-vlan host-association	17.12
switchport private-vlan mapping	17.13
switchport trunk allowed vlan	17.14
switchport trunk native vlan	17.16
switchport vlan-stacking (double tagging)	17.17
switchport voice dscp	17.18
switchport voice vlan	17.19
switchport voice vlan priority	17.21
vlan	17.22
vlan classifier activate	17.23
vlan classifier group	17.24
vlan classifier rule ipv4	17.25
vlan classifier rule proto	17.26
vlan database	17.28

Command List

This chapter provides an alphabetical reference of commands used to configure VLANs. For more information see [Chapter 16, VLAN Introduction](#).

private-vlan

Use this command to create a private VLAN. Private VLANs can be either primary or secondary. Secondary VLANs can be either community or isolated.

Use the **no** variant of this command to remove the specified private vlan.

For more information, see the section [“Private VLANs” on page 16.8](#).

Syntax `private-vlan <vlan-id> {community|isolated|primary}`
`no private-vlan <vlan-id> {community|isolated|primary}`

Parameter	Description
<vlan-id>	VLAN ID of the vlan which is to be made a private vlan.
community	Community vlan
isolated	Isolated vlan
primary	Primary vlan

Mode VLAN Configuration

Example

```
awplus# configure terminal
awplus(config)# vlan database
awplus(config-vlan)# vlan 2 name vlan2 state enable
awplus(config-vlan)# vlan 3 name vlan3 state enable
awplus(config-vlan)# vlan 4 name vlan3 state enable
awplus(config-vlan)# private-vlan 2 primary
awplus(config-vlan)# private-vlan 3 isolated
awplus(config-vlan)# private-vlan 4 community
```

private-vlan association

Use this command to associate a secondary VLAN to a primary VLAN. Only one isolated VLAN can be associated to a primary VLAN. Multiple community VLANs can be associated to a primary VLAN.

Use the **no** variant of this command to remove association of all the secondary VLANs to a primary VLAN.

For more information, see the section [“Private VLANs” on page 16.8](#).

Syntax `private-vlan <primary-vlan-id> association
{add <secondary-vlan-id> | remove <secondary-vlan-id>}`

Parameter	Description
<code><primary-vlan-id></code>	VLAN ID of the primary VLAN
<code><secondary-vlan-id></code>	VLAN ID of the secondary VLAN (either isolated or community)

Mode VLAN Configuration

Examples

```
awplus# configure terminal
awplus(config)# vlan database
awplus(config-vlan)# private-vlan 2 association add 3
awplus(config-vlan)# private-vlan 2 association remove 3
awplus(config-vlan)# no private-vlan 2 association
```

show vlan

Use this command to display information about a particular VLAN by specifying the VLAN ID. It displays information for all the VLANs configured.

Syntax `show vlan {all|brief|dynamic|static|<1-4094>}`

Parameter	Description
<1-4094>	Display information about the VLAN specified by the VLAN ID.
all	Display information about all VLANs on the device.
brief	Display information about all VLANs on the device.
dynamic	Display information about all VLANs learned dynamically.
static	Display information about all statically configured VLANs.

Mode User Exec and Privileged Exec

Example To display information about VLAN 2, use the command:

```
awplus# show vlan 2
```

Output Figure 17-1: Example output from the **show vlan** command

VLAN ID	Name	Type	State	Member ports (u)-Untagged, (t)-Tagged
2	VLAN0002	STATIC	ACTIVE	port1.0.5(u) port1.0.6(u) port1.0.7(u) port1.0.8(u)

Related Commands `vlan`

show vlan classifier group

Use this command to display information about all configured VLAN classifier groups or a specific group.

Syntax `show vlan classifier group [<1-16>]`

Parameter	Description
<1-16>	VLAN classifier group identifier

Mode User Exec and Privileged Exec

Usage If a group ID is not specified, all configured VLAN classifier groups are shown. If a group ID is specified, a specific configured VLAN classifier group is shown.

Example To display information about VLAN classifier group 1, enter the command:

```
awplus# show vlan classifier group 1
```

Related Commands [vlan classifier group](#)

show vlan classifier interface group

Use this command to display information about all interfaces configured for a VLAN group or all the groups.

Syntax `show vlan classifier interface group [<1-16>]`

Parameter	Description
<1-16>	VLAN classifier interface group identifier

Mode User Exec and Privileged Exec

Usage If a group ID is not specified, all interfaces configured for all VLAN classifier groups are shown. If a group ID is specified, the interfaces configured for this VLAN classifier group are shown.

Example To display information about all interfaces configured for VLAN group 1, enter the command:

```
awplus# show vlan classifier interface group 1
```

Output Figure 17-2: Example output from the `show vlan classifier interface group` command

```
vlan classifier group 1 interface port1.1.1
vlan classifier group 1 interface port1.1.2
```

Related Commands [vlan classifier group](#)

show vlan classifier rule

Use this command to display information about all configured VLAN classifier rules or a specific rule.

Syntax `show vlan classifier rule [<1-256>]`

Parameter	Description
<1-256>	VLAN classifier rule identifier

Mode User Exec and Privileged Exec

Usage If a rule ID is not specified, all configured VLAN classifier rules are shown. If a rule ID is specified, a specific configured VLAN classifier rule is shown.

Example To display information about VLAN classifier rule 1, enter the command:

```
awplus# show vlan classifier rule 1
```

Related Commands [vlan classifier activate](#)
[vlan classifier rule ipv4](#)
[vlan classifier rule proto](#)

show vlan private-vlan

Use this command to display the private-vlan configuration and associations.

Syntax `show vlan private-vlan`

Mode User Exec and Privileged Exec

Example To display the private-vlan configuration and associations, enter the command:

```
awplus# show vlan private-vlan
```

Output Figure 17-3: Example output from the `show vlan private-vlan` command

PRIMARY	SECONDARY	TYPE	INTERFACES
-----	-----	-----	-----
2	3	isolated	
2	4	community	

Related Commands [private-vlan](#)
[private-vlan association](#)

switchport access vlan

Use this command to change the port-based VLAN of the current port.

Use the **no** variant of this command to change the port-based VLAN of this port to the default VLAN, *vlan1*.

Syntax `switchport access vlan <vlan-id>`
`no switchport access vlan`

Parameter	Description
<code><vlan-id></code>	<1-4094> The port-based VLAN ID for the port.

Default Reset the default VLAN 1 to specified switchports using the negated form of this command.

Mode Interface Configuration

Usage Any untagged frame received on this port will be associated with the specified VLAN.

Examples To change the port-based VLAN to VLAN 3 for `port1.0.2`, use the commands:

```
awplus# configure terminal
awplus(config)# interface port1.0.2
awplus(config-if)# switchport access vlan 3
```

To reset the port-based VLAN to the default VLAN 1 for `port1.0.2`, use the commands:

```
awplus# configure terminal
awplus(config)# interface port1.0.2
awplus(config-if)# no switchport access vlan
```

Validation Command `show interface switchport`

Related Commands `show vlan`

switchport enable vlan

This command enables the VLAN on the port manually once disabled by certain actions, such as QSP (QoS Storm Protection) or EPSR (Ethernet Protection Switching Ring). Note that if the VID is not given, all disabled VLANs are re-enabled.

Syntax `switchport enable vlan [<1-4094>]`

Parameter	Description
<code>vlan</code>	Re-enables the vlan on the port
<code><1-4094></code>	VLAN ID

Mode Interface Configuration

Example To re-enable the port1.0.1 from VLAN 1:

```
awplus# configure terminal
awplus(config)# interface port1.0.1
awplus(config-if)# switchport enable vlan 1
```

Related Commands `show mls qos interface storm-status`
`storm-window`

switchport mode access

Use this command to set the switching characteristics of the port to access mode. Received frames are classified based on the VLAN characteristics, then accepted or discarded based on the specified filtering criteria.

Syntax `switchport mode access [ingress-filter {enable|disable}]`

Parameter	Description
<code>ingress-filter</code>	Set the ingress filtering for the received frames.
<code>enable</code>	Turn on ingress filtering for received frames. This is the default value
<code>disable</code>	Turn off ingress filtering to accept frames that do not meet the classification criteria.

Default By default, ports are in access mode with ingress filtering on.

Usage Use access mode to send untagged frames only.

Mode Interface Configuration

Example

```
awplus# configure terminal
awplus(config)# interface port1.0.2
awplus(config-if)# switchport mode access ingress-filter
enable
```

Validation Command `show interface switchport`

switchport mode private-vlan

Use this command to make a layer 2 port a private-vlan host port or a promiscuous port.

Use the **no** variant of this command to remove the configuration.

Syntax `switchport mode private-vlan {host|promiscuous}`
`no switchport mode private-vlan {host|promiscuous}`

Parameter	Description
host	This port type can communicate with all other host ports assigned to the same community vlan, but it cannot communicate with the ports in the same isolated vlan. All communications outside of this vlan must pass through a promiscuous port in the associated primary vlan.
promiscuous	A promiscuous port can communicate with all interfaces, including the community and isolated ports within a private VLAN

Mode Interface Configuration

Examples

```
awplus# configure terminal
awplus(config)# interface port1.0.2
awplus(config-if)# switchport mode private-vlan host
awplus(config)# interface port1.0.3
awplus(config-if)# switchport mode private-vlan promiscuous
awplus(config)# interface port1.0.4
awplus(config-if)# no switchport mode private-vlan promiscuous
```

Related Commands [switchport private-vlan mapping](#)

switchport mode trunk

Use this command to set the switching characteristics of the port to trunk. Received frames are classified based on the VLAN characteristics, then accepted or discarded based on the specified filtering criteria.

Syntax `switchport mode trunk [ingress-filter {enable|disable}]`

Parameter	Description
<code>ingress-filter</code>	Set the ingress filtering for the frames received.
<code>enable</code>	Turn on ingress filtering for received frames. This is the default value.
<code>disable</code>	Turn off ingress filtering to accept frames that do not meet the classification criteria.

Default By default, ports are in access mode, are untagged members of the default VLAN (vlan1), and have ingress filtering on.

Mode Interface Configuration

Usage A port in trunk mode can be a tagged member of multiple VLANs, and an untagged member of one native VLAN.

To configure which VLANs this port will trunk for, use the [switchport trunk allowed vlan](#) command.

Example

```
awplus# configure terminal
awplus(config)# interface port1.1.3
awplus(config-if)# switchport mode trunk ingress-filter enable
```

Validation Command `show interface switchport`

switchport private-vlan host-association

Use this command to associate a primary vlan and a secondary VLAN to a host port. Only one primary and secondary vlan can be associated to a host port.

Use the **no** variant of this command to remove the association.

Syntax `switchport private-vlan host-association <primary-vlan-id> add
<secondary-vlan-id>`

`no switchport private-vlan host-association`

Parameter	Description
<code><primary-vlan-id></code>	VLAN ID of the primary vlan
<code><secondary-vlan-id></code>	VLAN ID of the secondary vlan (either isolated or community)

Mode Interface Configuration

Examples

```
awplus# configure terminal
awplus(config)# interface port1.0.2
awplus(config-if)# switchport private-vlan host-association 2
                    add 3

awplus# configure terminal
awplus(config)# interface port1.0.2
awplus(config-if)# no switchport private-vlan host-association
```

switchport private-vlan mapping

Use this command to associate a primary VLAN and a set of secondary VLANs to a promiscuous port.

Use the **no** variant of this to remove all the association of secondary VLANs to primary VLANs for a promiscuous port.

Syntax

```
switchport private-vlan mapping <primary-vlan-id> add
    <secondary-vid-list>

switchport private-vlan mapping <primary-vlan-id> remove
    <secondary-vid-list>

no switchport private-vlan mapping
```

Parameter	Description
<primary-vlan-id>	VLAN ID of the primary vlan
<secondary-vid-list>	VLAN ID of the secondary vlan (either isolated or community), or a range of VLANs, or a comma-separated list of VLANs and ranges.

Mode Interface Configuration

Usage This command can be applied to a switch port or a static channel group, but not a dynamic (LACP) channel group. LACP channel groups (dynamic/LACP aggregators) cannot be promiscuous ports in private VLANs.

Examples

```
awplus# configure terminal
awplus(config)# interface port1.0.2
awplus(config-if)# switchport private-vlan mapping 2 add 3-4
awplus(config-if)# switchport private-vlan mapping 2 remove 3-4
awplus(config-if)# no switchport private-vlan mapping
```

Related Commands [switchport mode private-vlan](#)

switchport trunk allowed vlan

Use this command to add VLANs to be trunked over this switch port. Traffic for these VLANs can be sent and received on the port.

The **all** parameter sets the port to be a tagged member of all the VLANs configured on the device. The **none** parameter removes all VLANs from the port's tagged member set. The **add** and **remove** parameters will add and remove VLANs to and from the port's member set.

Use the **no** variant of this command to reset switching characteristics of a specified interface to negate a trunked configuration specified with **switchport trunk allowed vlan**.

Syntax

```
switchport trunk allowed vlan all
switchport trunk allowed vlan none
switchport trunk allowed vlan add <vid-list>
switchport trunk allowed vlan remove <vid-list>
switchport trunk allowed vlan except <vid-list>
no switchport trunk
```

Parameter	Description
all	Allow all VLANs to transmit and receive through the port.
none	Allow no VLANs to transmit and receive through the port.
add	Add a VLAN to transmit and receive through the port.
remove	Remove a VLAN from transmit and receive through the port.
except	All VLANs, except the VLAN for which the VID is specified, are part of its port member set.
<vid-list>	<p><2-4094> The ID of the VLAN or VLANs that will be added to, or removed from, the port. A single VLAN, VLAN range, or comma-separated VLAN list can be set.</p> <p>For a VLAN range, specify two VLAN numbers: lowest, then highest number in the range, separated by a hyphen.</p> <p>For a VLAN list, specify the VLAN numbers separated by commas.</p> <p>Do not enter spaces between hyphens or commas when setting parameters for VLAN ranges or lists.</p>

Default By default, ports are untagged members of the default VLAN (vlan1).

Mode Interface Configuration

Examples The following shows adding a single VLAN to the port's member set.

```
awplus# configure terminal
awplus(config)# interface port1.0.2
awplus(config-if)# switchport trunk allowed vlan add 2
```

The following shows adding a range of VLANs to the port's member set.

```
awplus# configure terminal
awplus(config)# interface port1.0.2
awplus(config-if)# switchport trunk allowed vlan add 2-4
```

The following shows adding a list of VLANs to the port's member set.

```
awplus# configure terminal
awplus(config)# interface port1.0.2
awplus(config-if)# switchport trunk allowed vlan add 2,3,4
```

switchport trunk native vlan

Use this command to configure the native VLAN for this port. The native VLAN is used for classifying the incoming untagged packets.

Use the **no** variant of this command to revert the native VLAN to the default VLAN ID 1. Command negation removes all tagged VLANs, and sets the native VLAN to the default VLAN.

Syntax `switchport trunk native vlan {<vid>|none}`
`no switchport trunk native vlan`

Parameter	Description
<code><vid></code>	<code><2-4094></code> The ID of the VLAN that will be used to classify the incoming untagged packets. The VLAN ID must be a part of the VLAN member set of the port.
<code>none</code>	No native VLAN. Use either the parameter none or no to revert to the default VLAN 1 as the native VLAN for the specified interface switchport.

Default VLAN 1 (the default VLAN)

Mode Interface Configuration

Examples The following commands show configuration of VLAN 2 as the native vlan for interface port1.0.2:

```
awplus# configure terminal
awplus(config)# interface port1.0.2
awplus(config-if)# switchport trunk native vlan 2
```

The following commands revert the native VLAN to the default VLAN 1 for interface port 1.0.2:

```
awplus# configure terminal
awplus(config)# interface port1.0.2
awplus(config-if)# no switchport trunk native vlan
```

switchport vlan-stacking (double tagging)

Use this command to enable VLAN stacking on a port and set it to be a customer-edge-port or provider-port. This is sometimes referred to as VLAN double-tagging, nested VLANs, or QinQ.

Use **no** parameter with this command to disable VLAN stacking on an interface.

Syntax `switchport vlan-stacking {customer-edge-port|provider-port}`
`no switchport vlan-stacking`

Parameter	Description
<code>customer-edge-port</code>	Set the port to be a customer edge port. This port must already be in access mode.
<code>provider-port</code>	Set the port to be a provider port. This port must already be in trunk mode.

Default By default, ports are not VLAN stacking ports.

Mode Interface Configuration

Usage Use VLAN stacking to separate traffic from different customers so that they can be managed over a provider network

Traffic with an extra VLAN header added by VLAN stacking cannot be routed.

Example

```
awplus# configure terminal
awplus(config)# interface port1.0.2
awplus(config-if)# switchport vlan-stacking customer-edge-port
```

switchport voice dscp

Use this command to configure the layer 3 DSCP value advertised when the transmission of LLDP-MED Network Policy TLVs for voice devices is enabled. When LLDP-MED capable IP phones receive this network policy information, they transmit voice data with the specified DSCP value.

Use the **no** variant of this command to reset the DSCP value to the default, 0.

Syntax `switchport voice dscp <0-63>`
`no switchport voice dscp`

Parameter	Description
<code>dscp</code>	Specify a DSCP value for voice data
<code><0-63></code>	DSCP value

Default A DSCP value of 0 will be advertised.

Mode Interface Configuration

Usage LLDP-MED advertisements including Network Policy TLVs are transmitted via a port if:

- LLDP is enabled ([lldp run command on page 81.15](#))
- Voice VLAN is configured for the port ([switchport voice vlan command on page 17.19](#))
- The port is configured to transmit LLDP advertisements—enabled by default ([lldp transmit receive command on page 81.19](#))
- The port is configured to transmit Network Policy TLVs—enabled by default ([lldp med-tlv-select command on page 81.9](#))
- There is an LLDP-MED device connected to the port

Example To tell IP phones connected to port1.0.5 to send voice data with DSCP value 27, use the commands:

```
awplus# configure terminal
awplus(config)# interface port1.0.5
awplus(config-if)# switchport voice dscp 27
```

Related Commands [lldp med-tlv-select](#)
[show lldp](#)
[switchport voice vlan](#)

switchport voice vlan

Use this command to configure the Voice VLAN tagging advertised when the transmission of LLDP-MED Network Policy TLVs for voice endpoint devices is enabled. When LLDP-MED capable IP phones receive this network policy information, they transmit voice data with the specified tagging. This command also sets the ports to be spanning tree edge ports, that is, it enables spanning tree portfast on the ports.

Use the **no** variant of this command to remove LLDP-MED network policy configuration for voice devices connected to these ports. This does not change the spanning tree edge port status.

Syntax `switchport voice vlan [<vid>|dot1p|dynamic|untagged]`
`no switchport voice vlan`

Parameter	Description
<vid>	VLAN identifier, in the range 1 to 4094.
dot1p	The IP phone should send User Priority tagged packets, that is, packets in which the tag contains a User Priority value, and a VID of 0. (The User Priority tag is also known as the 802.1p priority tag, or the Class of Service (CoS) tag.)
dynamic	The VLAN ID with which the IP phone should send tagged packets will be assigned by RADIUS authentication.
untagged	The IP phone should send untagged packets.

Default By default, no Voice VLAN is configured, and therefore no network policy is advertised for voice devices.

Mode Interface Configuration

Usage LLDP-MED advertisements including Network Policy TLVs are transmitted via a port if:

- LLDP is enabled ([lldp run command on page 81.15](#))
- Voice VLAN is configured for the port using this command ([switchport voice vlan](#))
- The port is configured to transmit LLDP advertisements—enabled by default ([lldp transmit receive command on page 81.19](#))
- The port is configured to transmit Network Policy TLVs—enabled by default ([lldp med-tlv-select command on page 81.9](#))
- There is an LLDP-MED device connected to the port.

To set the priority value to be advertised for tagged frames, use the [switchport voice vlan priority command on page 17.21](#).

If the Voice VLAN details are to be assigned by RADIUS, then the RADIUS server must be configured to send the attribute 'Egress-VLANID (56)' or 'Egress-VLAN-Name (58)' in the RADIUS Accept message when authenticating a phone attached to this port. To set these attributes on the local RADIUS server, use the [egress-vlan-id command on page 63.17](#) or the [egress-vlan-name command on page 63.18](#).

For more information about configuring authentication for Voice VLAN, "[Configuring LLDP](#)" on [page 80.11](#).

If the ports have been set to be edge ports by the [switchport voice vlan](#) command, the **no** variant of this command will leave them unchanged as edge ports. To set them back to their default non-edge port configuration, use the [spanning-tree edgeport \(RSTP and MSTP\) command on page 19.27](#).

Examples To tell IP phones connected to port1.0.5 to send voice data tagged for VLAN 10, use the commands:

```
awplus# configure terminal
awplus(config)# interface port1.0.5
awplus(config-if)# switchport voice vlan 10
```

To tell IP phones connected to ports 1.0.8-1.0.12 to send priority tagged packets (802.1p priority tagged with VID 0, so that they will be assigned to the port VLAN) use the following commands. The priority value is 5 by default, but can be configured with the [switchport voice vlan priority](#) command.

```
awplus# configure terminal
awplus(config)# interface port1.0.8-port1.0.12
awplus(config-if)# switchport voice vlan dot1p
```

To dynamically configure the VLAN ID advertised to IP phones connected to port1.0.1 based on the VLAN assigned by RADIUS authentication (with RADIUS attribute 'Egress-VLANID' or 'Egress-VLAN-Name' in the RADIUS accept packet), use the commands:

```
awplus# configure terminal
awplus(config)# interface port1.0.1
awplus(config-if)# switchport voice vlan dynamic
```

To remove the Voice VLAN, and therefore disable the transmission of LLDP-MED network policy information for voice devices on port1.0.24, use the following commands:

```
awplus# configure terminal
awplus(config)# interface port1.0.24
awplus(config-if)# no switchport voice vlan
```

Related Commands

- [egress-vlan-id](#)
- [egress-vlan-name](#)
- [lldp med-tlv-select](#)
- [spanning-tree edgeport \(RSTP and MSTP\)](#)
- [switchport voice dscp](#)
- [switchport voice vlan priority](#)
- [show lldp](#)

switchport voice vlan priority

Use this command to configure the Layer 2 user priority advertised when the transmission of LLDP-MED Network Policy TLVs for voice devices is enabled. This is the priority in the User Priority field of the IEEE 802.1Q VLAN tag, also known as the Class of Service (CoS), or 802.1p priority. When LLDP-MED capable IP phones receive this network policy information, they transmit voice data with the specified priority.

Syntax `switchport voice vlan priority <0-7>`
`no switchport voice vlan priority`

Parameter	Description
<code>priority</code>	Specify a user priority value for voice data
<code><0-7></code>	Priority value

Default By default, the Voice VLAN user priority value is 5.

Mode Interface Configuration

Usage LLDP-MED advertisements including Network Policy TLVs are transmitted via a port if:

- LLDP is enabled ([lldp run command on page 81.15](#))
- Voice VLAN is configured for the port ([switchport voice vlan command on page 17.19](#))
- The port is configured to transmit LLDP advertisements—enabled by default ([lldp transmit receive command on page 81.19](#))
- The port is configured to transmit Network Policy TLVs—enabled by default ([lldp med-tlv-select command on page 81.9](#))
- There is an LLDP-MED device connected to the port.

To set the Voice VLAN tagging to be advertised, use the [switchport voice vlan command on page 17.19](#).

Example To tell IP phones connected to port1.0.5 to send voice data with a user priority value of 6, use the commands:

```
awplus# configure terminal
awplus(config)# interface port1.0.5
awplus(config-if)# switchport voice vlan priority 6
```

Related Commands [lldp med-tlv-select](#)
[show lldp](#)
[switchport voice vlan](#)

vlan

This command creates VLANs, assigns names to them, and enables or disables them. Specifying the `disable` state causes all forwarding over the specified VLAN ID to cease. Specifying the `enable` state allows forwarding of frames on the specified VLAN.

The `no` variant of this command destroys the specified VLANs.

Syntax

```
vlan <vid> [name <vlan-name>] [state {enable|disable}]
vlan <vid-range> [state {enable|disable}]
no vlan {<vid>|<vid-range>}
```

Parameter	Description
<vid>	The VID of the VLAN that will be enabled or disabled <2-4094>.
<vlan-name>	The ASCII name of the VLAN. Maximum length: 32 characters.
<vid-range>	Specifies a range of VLAN identifiers.
enable	Sets VLAN into an enable state.
disable	Sets VLAN into a disable state.

Default By default, VLANs are enabled when they are created.

Mode VLAN Configuration

Example

```
awplus# configure terminal
awplus(config)# vlan database
awplus(config-vlan)# vlan 45 name accounts state enable
```

Related Commands

- vlan database
- show vlan

vlan classifier activate

Use this command to associate a VLAN classifier group with the switch port.

Use the **no** variant of this command to remove the group from the switch port.

Syntax `vlan classifier activate <vlan-class-grp-id>`
`no vlan classifier activate`

Parameter	Description
<code><vlan-class-grp-id></code>	VLAN classifier group identifier (1-16).

Mode Interface Configuration

Example To associate VLAN classifier group 3 with switch port 1.1.3

```
awplus# configure terminal
awplus(config)# interface port1.1.3
awplus(config-if)# vlan classifier activate 3
```

Related Commands [show vlan classifier rule](#)
[vlan classifier group](#)
[vlan classifier rule ipv4](#)
[vlan classifier rule proto](#)

vlan classifier group

Use this command to create a group of VLAN classifier rules. The rules must already have been created.

Use the **no** variant of this command to delete a group of VLAN classifier rules.

Syntax `vlan classifier group <1-16> {add|delete} rule <vlan-class-rule-id>`
`no vlan classifier group <1-16>`

Parameter	Description
<1-16>	VLAN classifier group identifier
add	Add the rule to the group.
delete	Delete the rule from the group.
<vlan-class-rule-id>	The VLAN classifier rule identifier.

Mode Global Configuration

Example

```
awplus# configure terminal
awplus(config)# vlan classifier group 3 add rule 5
```

Related Commands `show vlan classifier rule`
`vlan classifier activate`
`vlan classifier rule ipv4`
`vlan classifier rule proto`

vlan classifier rule ipv4

Use this command to create an IPv4 subnet-based VLAN classifier rule and map it to a specific VLAN. Use the **no** variant of this command to delete the VLAN classifier rule.

Syntax `vlan classifier rule <1-256> ipv4 <ip-addr/prefix-length> vlan <1-4094>`

`no vlan classifier rule <1-256>`

Parameter	Description
<1-256>	VLAN Classifier Rule identifier
<ip-addr/prefix-length>	The IP address and prefix length
<1-4094>	VLAN to which an untagged packet is mapped.

Mode Global Configuration

Usage If the source IP address matches the IP subnet specified in the VLAN classifier rule, the received packets are mapped to the specified VLAN.

Note  The subnet VLAN classifier only matches IPv4 packets. It does not match ARP packets. To ensure ARP traffic is classified into the correct subnet VLAN, you can use a hardware based policy map that sends ARP packets to the CPU, which will then process them appropriately. This means that if you use subnet-based VLANs, you should also configure the following:

```
!
vlan database
  vlan 10 state enable
!
vlan classifier rule 1 ipv4 192.168.10.0/24 vlan 10
vlan classifier group 1 add rule 1
!
mls qos enable
access-list 4000 send-to-cpu any any
!
class-map 1
  match access-group 4000
  match eth-format ethii-untagged protocol 0806
!
policy-map 1
  class default
    class 1
```

Note  The policy map should be applied to each port that uses a subnet based VLAN using the service-policy input command:

```
!
interface port2.0.1
  switchport
  switchport mode access
  vlan classifier activate 1
  service-policy input 1
```

Example

```
awplus# configure terminal
awplus(config)# vlan classifier rule 3 ipv4 3.3.3.3/8 vlan 5
```

Related Commands [show vlan classifier rule](#)
[vlan classifier activate](#)
[vlan classifier rule proto](#)

vlan classifier rule proto

Use this command to create a protocol type-based VLAN classifier rule, and map it to a specific VLAN.

The **no** variant of this command destroys the rule.

Syntax `vlan classifier rule <1-256> proto <protocol>
 encap {ethv2|nosnapllc|snapllc} vlan <vid>`

`no vlan classifier rule <1-256>`

Parameter	Description
<1-256>	VLAN Classifier identifier
proto	Protocol type
<protocol>	Specify a protocol either by its decimal number (0-65535) or by one of the following protocol names:
[arp 2054]	Address Resolution protocol
[atalkarp 33011]	Appletalk AARP protocol
[atalkddp 32923]	Appletalk DDP protocol
[atmmulti 34892]	MultiProtocol Over ATM protocol
[atmtransport 34948]	Frame-based ATM Transport protocol
[dec 24576]	DEC Assigned protocol
[deccustom 24582]	DEC Customer use protocol
[decdiagnostics 24581]	DEC Systems Comms Arch protocol
[decdnadumpload 24577]	DEC DNA Dump/Load protocol
[decdnaremoteconsole 24578]	DEC DNA Remote Console protocol
[decdnarouting 24579]	DEC DNA Routing protocol
[declat 24580]	DEC LAT protocol
[decsyscomm 24583]	DEC Systems Comms Arch protocol
[g8bpqx25 2303]	G8BPQ AX.25 protocol

Parameter (cont.)	Description (cont.)
[ieeeaddrtrans 2561]	Xerox IEEE802.3 PUP Address
[ieeepup 2560]	Xerox IEEE802.3 PUP protocol
[ip 2048]	IP protocol
[ipx 33079]	IPX protocol
[netbeui 61680]	IBM NETBIOS/NETBEUI protocol
[netbeui 61681]	IBM NETBIOS/NETBEUI protocol
[pppdiscovery 34915]	PPPoE discovery protocol
[pppsession 34916]	PPPoE session protocol
[rarp 32821]	Reverse Address Resolution protocol
[x25 2056]	CCITT .25 protocol
[xeroxaddrtrans 513]	Xerox PUP Address Translation protocol
[xerospup 512]	Xerox PUP protocol
ethv2	Ethernet Version 2 encapsulation
nosnapllc	LLC without SNAP encapsulation
snapllc	LLC SNAP encapsulation
<vid>	VLAN ID to which an untagged packet is mapped (2-4094)

Mode Global Configuration

Usage If the protocol type matches the protocol specified in the VLAN classifier rule, the received packets are mapped to the specified VLAN. Ethernet Frame Numbers may be entered in place of the protocol names listed. For a full list please refer to the IANA list online: <http://www.iana.org/assignments/ethernet-numbers>.

Example

```
awplus# configure terminal
awplus(config)# vlan classifier rule 1 proto x25 encap ethv2
vlan 2
awplus(config)# vlan classifier rule 2 proto 512 encap ethv2
vlan 2
awplus(config)# vlan classifier rule 3 proto 2056 encap ethv2
vlan 2
awplus(config)# vlan classifier rule 4 proto 2054 encap ethv2
vlan 2
```

Validation Output

```
awplus# show vlan classifier rule
```

```
vlan classifier rule 16 proto rarp encap ethv2 vlan 2
vlan classifier rule 8 proto encap ethv2 vlan 2
vlan classifier rule 4 proto arp encap ethv2 vlan 2
vlan classifier rule 2 proto xeroxpup encap ethv2 vlan 2
```

Related Commands [show vlan classifier rule](#)
[vlan classifier activate](#)
[vlan classifier group](#)

vlan database

Use this command to enter the VLAN Configuration mode.

Syntax `vlan database`

Mode Global Configuration

Usage Use this command to enter the VLAN configuration mode. You can then add or delete a VLAN, or modify its values.

Example In the following example, note the change to VLAN configuration mode from Configure mode:

```
awplus# configure terminal
awplus(config)# vlan database
awplus(config-vlan)#
```

Related Commands [vlan](#)

Chapter 18: Spanning Tree Introduction: STP, RSTP, and MSTP



Introduction.....	18.2
Overview of Spanning Trees.....	18.2
Spanning tree operation.....	18.2
Spanning tree modes.....	18.4
Spanning Tree Protocol (STP).....	18.5
Configuring STP.....	18.6
Rapid Spanning Tree Protocol (RSTP).....	18.7
Configuring RSTP.....	18.8
Multiple Spanning Tree Protocol (MSTP).....	18.10
Multiple Spanning Tree Instances (MSTI).....	18.11
MSTP Regions.....	18.12
Common and Internal Spanning Tree (CIST).....	18.14
MSTP Bridge Protocol Data Units (BPDUs).....	18.16
Configuring MSTP.....	18.18

Introduction

This chapter describes and provides configuration procedures for:

- Spanning Tree Protocol (STP)
- Rapid Spanning Tree Protocol (RSTP)
- Multiple Spanning Tree Protocol (MSTP)

For detailed information about the commands used to configure spanning trees, see [Chapter 19, Spanning Tree Commands](#).

Overview of Spanning Trees

The concept of the spanning tree protocol was devised to address broadcast storming. The spanning tree algorithm itself is defined by the IEEE standard 802.1D and its later revisions.

The IEEE Standard 802.1 uses the term “bridge” to define the spanning tree operation and uses terms such as Bridge Protocol Data Units, Root Bridge etc., when defining spanning tree protocol functions.

When a bridge receives a frame, it reads the source and destination address fields. The bridge then enters the frame's source address in its forwarding database. In doing this the bridge associates the frame's source address with the network attached to the port on which the frame was received. The bridge also reads the destination address and if it can find this address in its forwarding database, it forwards the frame to the appropriate port. If the bridge does not recognize the destination address, it forwards the frame out from all its ports except for the one on which the frame was received, and then waits for a reply. This process is known as “flooding”.

A significant problem arises where bridges connect via multiple paths. A frame that arrives with an unknown destination address is flooded over all available paths. The arrival of these frames at another network via different paths and bridges produces major problems. The bridges can become confused about the location of the send and receive devices and begin sending frames in the wrong directions. This process feeds on itself and produces a condition known as a broadcast storm, where the increase of circulating frames can eventually overload the network.

Spanning tree operation

Where a LAN's topology results in more than one path existing between bridges, frames transmitted onto the extended LAN circulate in increasing numbers around the loop, decreasing performance and potentially overloading the network. However, multiple paths through the extended LAN are often required in order to provide redundancy and backup in the event of a bridge or link failure.

The spanning tree is created through the exchange of Bridge Protocol Data Units (BPDUs) between the bridges in the LAN. The spanning tree algorithm operates by:

- Automatically computing a loop-free portion of the topology, called a *spanning tree*. The topology is dynamically pruned to the spanning tree by declaring certain ports on a switch to be redundant, and placing them into a ‘Blocking’ state.
- Automatically recovering from a switch failure that would partition the extended LAN by reconfiguring the spanning tree to use redundant paths, if available.

The logical tree computed by the spanning tree algorithm has the following properties:

- A single bridge is selected to become the spanning tree's unique *root bridge*. This is the device that advertises the lowest Bridge ID. Each bridge is uniquely identified by its Bridge ID, which comprises the bridge's *root priority* (a spanning tree parameter) followed by its MAC address.
- Each bridge or LAN in the tree, except the root bridge, has a unique parent, known as the *designated bridge*. Each LAN has a single bridge, called the *designated bridge*, that connects it to the next LAN on the path towards the root bridge.
- Each port connecting a bridge to a LAN has an associated *cost*, called the *root path cost*. This is the sum of the costs for each path between the particular bridge port and the root bridge. The designated bridge for a LAN is the one that advertises the lowest *root path cost*. If two bridges on the same LAN have the same lowest root path cost, then the switch with the lowest bridge ID becomes the designated bridge.

The spanning tree computation is a continuous, distributed process to establish and maintain a spanning tree (Table 18-1). The basic algorithm is similar for STP, RSTP and MSTP modes.

Table 18-1: Spanning tree process

The spanning tree algorithm ...	By ...
Selects a root bridge	It selects as the root bridge for the spanning tree the device with the (numerically) lowest bridge identifier (that is, the device with lowest root bridge priority value, or if they have the same priority, the bridge with the lowest MAC address).
Selects root ports	On each device, it selects the root port according to: <ul style="list-style-type: none"> ■ the port with the lowest path cost to the root bridge ■ the port connected to the bridge with the lowest root identifier ■ MSTP and RSTP only: the port with the lowest port priority value ■ the port with the lowest port number¹
Blocks alternate ports	In order to prevent loops, it blocks alternate ports (Discarding state) that provide higher cost paths to the root bridge.
Blocks backup ports	Where a second port connects one switch back to itself, it blocks the backup port that has the highest path cost or port number.
Selects designated ports	All other ports that are not disabled are selected as designated ports and are eventually made active (Forwarding state).
Maintains the spanning tree	If a switch or port fails, the spanning tree configures a new active topology, changing some port states, to reestablish connectivity and block loops. Depending on where the failure occurs, the changes may be widespread (e.g., if the root bridge fails), or local (e.g., if a designated port fails).

1. The whole three part port number (D.M.P) is used to find the lowest port number; where: D is the device number within a stack (1 for a non stacked device), M is the module number (XEM number) within the device - note that 0 is used for all base-board connected ports, and P is the number of the port within the XEM or base-board.

The logical spanning tree, sometimes called the *active topology*, includes the root bridge and all designated bridges, meaning all ports that are to be used for communication within the spanning tree. These ports are in the forwarding state. Ports removed from the logical spanning tree are not in the forwarding state. To implement the spanning tree algorithm, devices communicate with one another using the Spanning Tree Protocol.

Spanning tree modes

STP can run in one of three modes: STP, RSTP or MSTP. A device running RSTP is compatible with other devices running STP; a device running MSTP is compatible with other devices running RSTP or STP. By default, on a device in MSTP mode each port automatically detects the mode of the device connected to it (MSTP, RSTP or STP), and responds in the appropriate mode by sending messages (BPDUs) in the corresponding format. Ports on a device in RSTP mode can automatically detect and respond to connected devices in RSTP and STP mode. Particular ports can also be forced to only operate in a particular mode ([spanning-tree force-version command on page 19.31](#)).

STP The Spanning Tree Protocol (STP) is the original protocol defined by IEEE standard 802.1D-1988. It creates a single spanning tree over a network.

STP mode may be useful for supporting applications and protocols whose frames may arrive out of sequence or duplicated, for example NetBeui.

RSTP Rapid Spanning Tree Protocol (RSTP) also creates a single spanning tree over a network. Compared with STP, RSTP provides for more rapid convergence to an active spanning tree topology. RSTP is defined in IEEE standard 802.1D-2004.

By default, the device operates in RSTP mode.

MSTP The Multiple Spanning Tree Protocol (MSTP) addresses the limitations in the previous spanning tree protocols, STP and RSTP, within networks that use multiple VLANs with topologies that employ alternative physical links. It supports multiple spanning tree instances on any given link within a network, and supports large networks by grouping bridges into regions that appear as a single bridge to other devices.

MSTP is defined in IEEE standard 802.1Q-2005. The protocol builds on, and remains compatible with, the previous IEEE standards defining STP and RSTP.

Spanning Tree Protocol (STP)

STP uses the process described in [Table 18-1](#) to avoid loops.

STP port states In STP mode, each switch port can be in one of five spanning tree states, and one of two switch states. The state of a switch port is taken into account by STP. The STP port states ([Table 18-2](#)) affect the behavior of ports whose switch state is enabled.

Table 18-2: STP port states

State	Meaning
DISABLED	STP operations are disabled on the port. The port does not participate in the operation of the Spanning Tree Algorithm and Protocol. The port can still switch if its switch state is enabled.
BLOCKING	The forwarding process discards received frames and does not submit forwarded frames for transmission. This is the "standby" mode. The port does not participate in frame relay.
LISTENING	The port is enabled for receiving frames only. The port is preparing to participate in frame relay. The forwarding process discards received frames and does not submit forwarded frames for transmission.
LEARNING	The port is enabled for receiving frames only, and the Learning Process can add new source address information to the Forwarding Database.
FORWARDING	The normal state for a switch port. The forwarding process and the Spanning Tree entity are enabled for transmit and receive operations on the port.

Configuring STP

By default, RSTP is enabled on all switch ports. This section provides a procedure for configuring STP (Table 18-3).

To configure other modes, see “Configuring RSTP” on page 18.8 or “Configuring MSTP” on page 18.18.

Table 18-3: Configuration procedure for STP

Configure STP	
RSTP is enabled by default with default settings on all switch ports to prevent layer 2 loops in your network.	
<code>awplus#</code>	Enter Global Configuration mode.
<code>configure terminal</code>	
<code>awplus(config)#</code>	By default, the device is in RSTP mode. Change to STP mode.
<code>spanning-tree mode stp</code>	
<code>awplus(config)#</code>	By default, spanning tree is enabled on all switch ports. If it has been disabled, enable it for STP.
<code>spanning-tree {mstp rstp stp} enable</code>	
<code>awplus(config)#</code>	By default, all devices have the same root bridge priority, 32768 (8000 in hexadecimal), so the device with the lowest MAC address becomes the root bridge. If you want the device to be the root bridge, set the root bridge priority to a value lower than 32768. (If you enter a number that is not a multiple of 4096, the switch rounds the number down.)
<code>spanning-tree priority <priority></code>	
Configure Root Guard	
The Root Guard feature makes sure that the port on which it is enabled is a designated port. If the Root Guard enabled port receives a superior BPDU, it goes to a Listening state (for STP) or discarding state (for RSTP and MSTP).	
<code>awplus(config)#</code>	Enter Interface Configuration mode for the switch ports you want to enable Root Guard for.
<code>interface <port-list></code>	
<code>awplus(config-if)#</code>	Enable the Guard Root feature for these ports.
<code>spanning-tree guard root</code>	
<code>awplus(config-if)#</code>	Return to Global Configuration mode.
<code>exit</code>	
<code>awplus(config)#</code>	Return to Privileged Exec mode.
<code>exit</code>	
Check STP configuration	
<code>awplus#</code>	Display the spanning tree configuration for the device, and confirm the new root bridge priority (Bridge Priority).
<code>show spanning-tree [interface <port-list>]</code>	Note that the Bridge ID is in a form like this: 80000000cd240331, and that other IDs follow the same pattern. This is made up of: <ul style="list-style-type: none"> ■ 8000—the devices' root bridge priority in hexadecimal ■ 0000cd240331—the devices' MAC address.

Advanced configuration: For most networks the default settings for path costs will be suitable, however, you can configure them if required (`spanning-tree path-cost`).

Rapid Spanning Tree Protocol (RSTP)

RSTP uses the process described in [Table 18-1](#) to avoid loops.

A spanning tree running in STP mode can take up to one minute to rebuild after a topology or configuration change. The RSTP algorithm provides for a faster recovery of connectivity following the failure of a bridge, bridge port, or a LAN. RSTP provides rapid recovery by including port roles in the computation of port states, and by allowing neighboring bridges to explicitly acknowledge signals on a point-to-point link that indicate that a port wants to enter the forwarding mode.

In rapid mode, the rapid transition of a port to the forwarding state is possible when the port is considered to be part of a point-to-point link, or when the port is considered to be an *edge* port. An edge port is one that attaches to a LAN that has no other bridges attached.

Table 18-4: RSTP port states

State	Meaning
DISABLED	STP operations are disabled on the port.
DISCARDING	The port does not participate in frame relay. The forwarding process discards received frames and does not submit forwarded frames for transmission.
LEARNING	The port is enabled for receiving frames only, and the learning process can add new source address information to the forwarding database. The port does not forward any frames.
FORWARDING	The normal state for a switch port. The forwarding process and the Spanning Tree entity are enabled for transmit and receive operations on the port.

Configuring RSTP

RSTP is enabled by default with default settings on all switch ports to prevent layer 2 loops in your network. No further configuration is required if you want to use RSTP with these default settings. For further RSTP configuration, see [Table 18-5](#) below.

To configure other modes, see “[Configuring MSTP](#)” on page 18.18 or “[Configuring STP](#)” on page 18.6.

For detailed configuration examples, see the How To Note *How To Configure Basic Switching Functionality*, available from <http://www.alliedtelesis.com>.

Table 18-5: Configuration procedure for RSTP

	Command	Description
	RSTP is enabled by default with default settings on all switch ports to prevent layer 2 loops in your network. No further configuration is required if you want to use RSTP with these default settings. If you need to restore the device to RSTP after it has been set to another mode, or modify the default RSTP settings, follow the procedure below.	
<code>awplus#</code>	<code>configure terminal</code>	Enter Configuration mode.
<code>awplus(config)#</code>	<code>spanning-tree mode rstp</code>	By default, the device is in RSTP mode. If it has been changed to STP or MSTP mode, change it back to RSTP.
<code>awplus(config)#</code>	<code>spanning-tree {mstp rstp stp} enable</code>	By default, RSTP is enabled on all switch ports. If it has been disabled, enable it.
<code>awplus(config)#</code>	<code>spanning-tree priority <priority></code>	By default, all devices have the same root bridge priority, 32768 (8000 in hexadecimal), so the device with the lowest MAC address becomes the root bridge. If you want the device to be the root bridge, set the root bridge priority to a value lower than 32768. (If you enter a number that is not a multiple of 4096, the switch rounds the number down.)
Configure edge ports		
If some switch ports are connected to devices that cannot generate BPDUs (such as workstations), you can set particular switch ports as edge ports, or set them to automatically detect whether they are edge ports.		
<code>awplus(config)#</code>	<code>interface (to configure) <port-list></code>	Enter Interface Configuration mode for these switch ports.
<code>awplus(config-if)#</code>	<code>spanning-tree edgeport</code>	Set these ports to be edge ports,
<code>awplus(config-if)#</code>	OR	OR
	<code>spanning-tree autoedge</code>	Set these ports to automatically detect whether they are edge ports.
Configure Root Guard		
<code>awplus(config-if)#</code>	<code>exit</code>	Return to Global Configuration mode.
<code>awplus(config)#</code>	<code>spanning-tree guard root</code>	The Root Guard feature makes sure that the port on which it is enabled is a designated port. If the Root Guard enabled port receives a superior BPDU, it goes to a Listening state (for STP) or discarding state (for RSTP and MSTP). Enable the Guard Root feature if required.

Table 18-5: Configuration procedure for RSTP (cont.)

	Command	Description
Configure BPDU Guard		
awplus(config)#	spanning-tree portfast bpdu-guard	If required, enable the BPDU Guard feature, and configure timeout parameters.
awplus(config)#	spanning-tree errdisable-timeout enable	
awplus(config)#	spanning-tree errdisable-timeout interval <10-1000000>	
Check RSTP configuration		
awplus(config)#	exit	Return to Privileged Exec mode.
awplus#	show spanning-tree [interface <port-list>]	Display the spanning tree configuration for the device, and confirm the new root bridge priority (Bridge Priority). Note that the Bridge ID is in a form like this: 80000000cd240331, and that other IDs follow the same pattern. This is made up of: <ul style="list-style-type: none"> ■ 8000—the devices' root bridge priority in hexadecimal ■ 0000cd240331—the devices' MAC address.

Advanced configuration: For most networks the default settings for path costs will be suitable, however, you can configure them if required ([spanning-tree path-cost](#)).

Multiple Spanning Tree Protocol (MSTP)

Conceptually, MSTP views the total bridged network as one that comprises a number of *Multiple Spanning Tree Regions* (MSTRs), where each region can contain up to 64 spanning trees, which operate locally, called *Multiple Spanning Tree Instances* (MSTIs). AlliedWare Plus™ supports up to 15 MSTIs. The regions are linked by the *Common Internal Spanning Tree* (CIST).

MSTP uses BPDUs to exchange information between spanning-tree compatible devices, to prevent loops in each MSTI and also in the CIST, by selecting active and blocked paths. This process is described in [Table 18-1](#).

If multiple ports are aggregated together into a dynamic (LACP) or static channel group, then the spanning-tree process is aware of the link aggregation and treats the aggregated ports as a single logical path.

Advantage of MSTP over RSTP

MSTP is similar to RSTP, in that it provides loop resolution and rapid convergence. However, RSTP can keep track of only one spanning-tree. MSTP can track many spanning-trees, referred to as *instances*. MSTP makes it possible to have different forwarding paths for different MST instances. This enables load balancing of network traffic across redundant links, so that all the links in a network can be used by at least one MSTI, and no link is left completely idle. That is to say that no link is unnecessarily shut down by spanning-tree.

Essentially, MSTP is VLAN aware and RSTP is not VLAN aware. MSTP BPDUs and RSTP BPDUs are compatible, so a network can have a mixture of MSTP and RSTP areas.

Multiple Spanning Tree Instances (MSTI)

MSTP enables the grouping and mapping of VLANs to different spanning tree instances. So, an MST Instance (MSTI) is a particular set of VLANs that are all using the same spanning tree.

In a network where all VLANs span all links of the network, judicious choice of bridge priorities for different MSTIs can result in different switches becoming root bridges for different MSTIs. That will result in the different MSTIs choosing different active topologies on the network. An example of how different MSTIs can choose different active topologies on the same physical set of links is illustrated in Figure 18-1.

MSTP is compatible with RSTP and STP—see “Common and Internal Spanning Tree (CIST)” on page 18.14.

Figure 18-1: Different spanning trees created by different MSTIs on the same physical layout

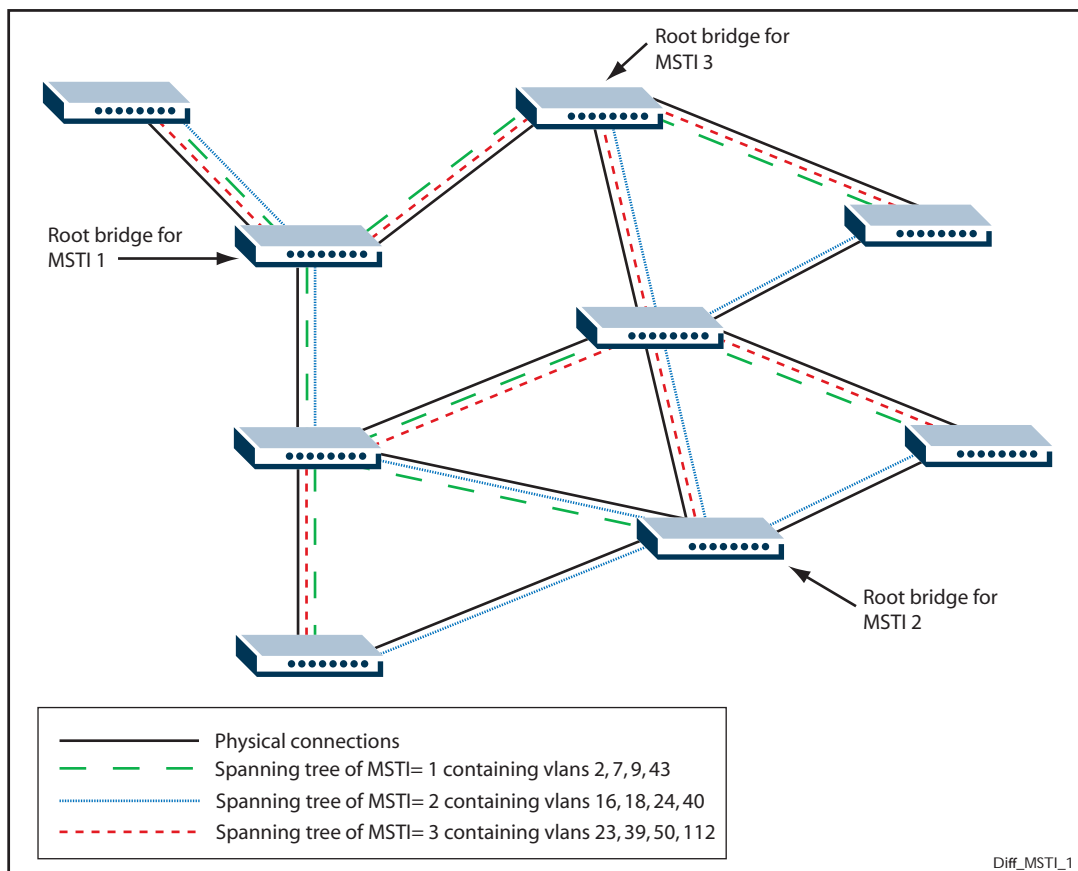

MSTP Regions

An MST region is a set of interconnected switches that all have the same values for the following MST configuration identification elements:

- MST configuration name - the name of the MST region
- Revision level - the revision number of configuration
- Configuration Digest - the mapping of which VLANs are mapped to which MST instances

Each of the MST instances created are identified by an MSTI number. This number is locally significant within the MST region. Therefore, an MSTI will not span across MST regions.

Figure 18-2: MSTIs in different regions

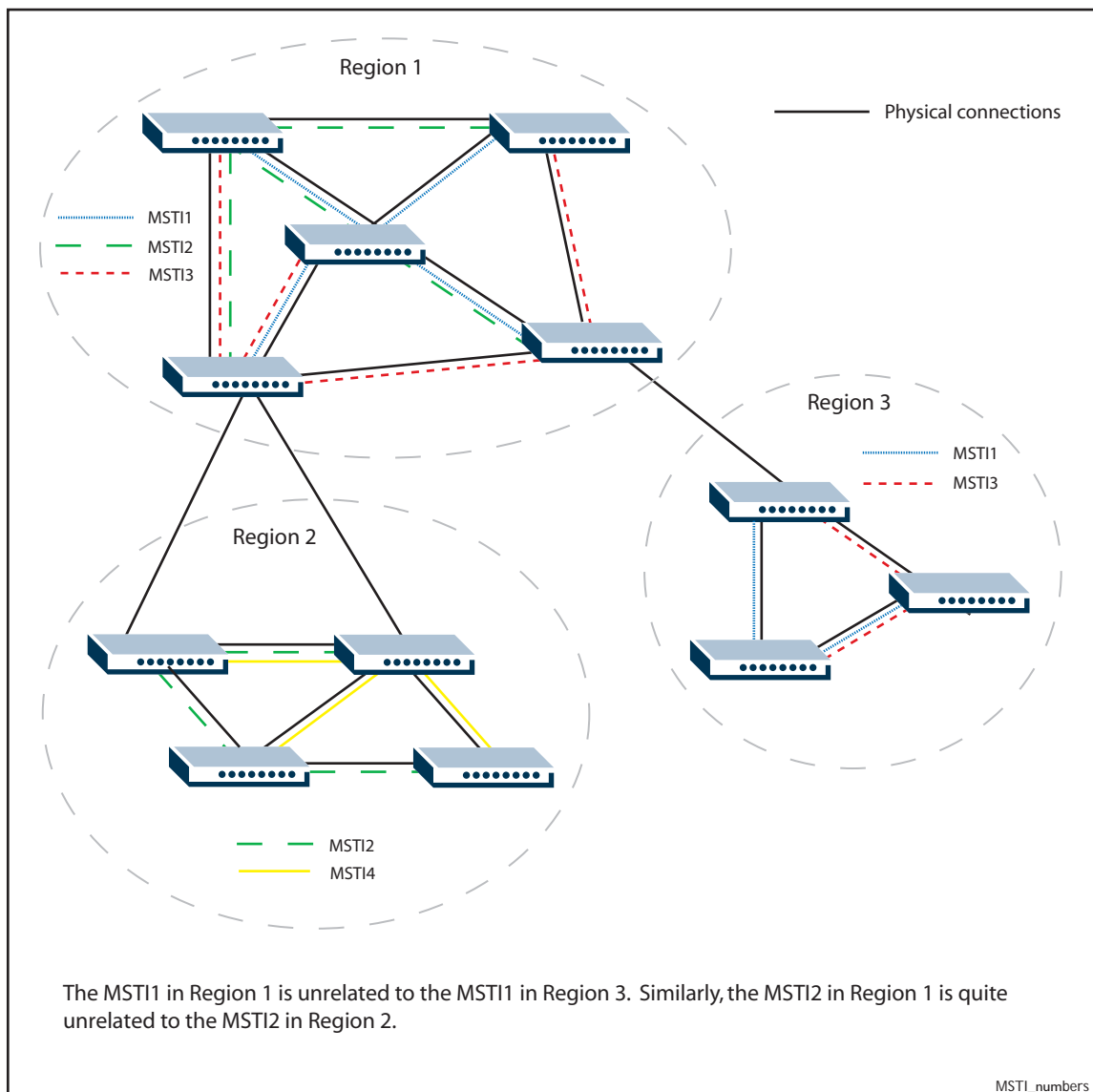

The task of assigning each bridge to a particular region is achieved by the member bridges each comparing their *MST Configuration Identifiers*. More information on configuration identifiers is provided in [Table 18-6](#), but for the moment an *MST Configuration Identifier* can simply be thought of as an identifier that represents the mapping of VLANs to MSTIs within each bridge. Therefore, bridges with identical *MST Configuration Identifiers*, must have identical MSTI mapping tables.

While each MSTI can have multiple VLANs, each VLAN can be associated with only one MSTI. Once these associations have been made, the bridges in each region can transmit their spanning tree BPDUs and advertise their MSTIs. This in turn establishes the active data paths between the bridges for each group of VLANs (that is, for each MSTI) and block any duplicate paths within each instance. A particular advantage of this enhancement applies where a large number of VLANs share a few internetwork paths. In this situation there need only be as many Multiple Spanning Tree Instances (MSTIs) as there are source and destination bridge pairs, remembering that a pair of bridges probably has multiple paths between them.

In order to ensure that each bridge within a region maintains the same configuration information (particularly their VID to MSTI mappings) and to ensure each bridge's membership of a particular region, the bridges exchange configuration information in the form of *MST Configuration Identifiers*. [Table 18-6](#) provides a breakdown of an *MST Configuration Identifier*. A detailed explanation of bridge configuration identifiers can be found in Section 13.7 of the IEEE 802.1Q-2003 standard.

Table 18-6: MST Configuration Identifier

Field Name	Description
Format Selector	A single octet field whose value of 0 indicates MSTP operation
Region Name	A name (up to 32 characters long) that identifies a particular MST region, defined using the region (MSTP) command on page 19.9
Revision Level	A number representing the region's revision level, defined using the revision (MSTP) command on page 19.10 .
Configuration Digest	A 16 octet (HMAC-MD5 based) signature created from the MST configuration table.

Common and Internal Spanning Tree (CIST)

The CIST is the default spanning tree instance of MSTP, i.e. all VLANs that are not members of particular MSTIs are members of the CIST. Also, an individual MST region can be regarded as a single virtual bridge by other MST regions. The spanning tree that runs between regions is the CIST. The CIST is also the spanning tree that runs between MST regions and Single Spanning Tree (SST) entities. So, in [Figure 18-3](#), the STP that is running between the regions, and to the SST bridges, is the CIST.

Figure 18-3: The CIST operates on links between regions and to SST devices

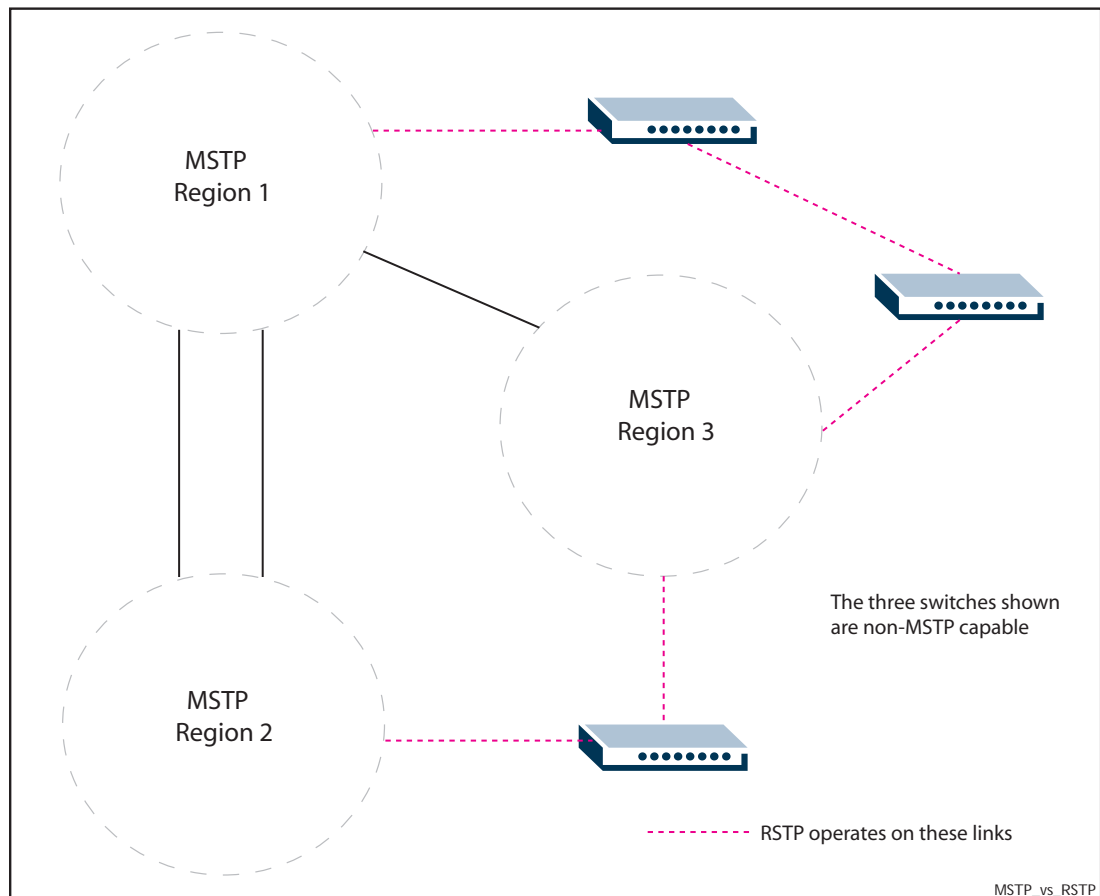

Compatibility with Previous Spanning Tree Protocols

MSTP provides for compatibility with older spanning tree protocols in several ways. In addition to the MST region described in the previous section, the protocol provides for single spanning tree systems by employing a Common and Internal Spanning Tree (CIST). The CIST applies a common and internal spanning tree protocol to the whole of the bridged network and is a direct equivalent to the internal spanning tree (IST) protocol of earlier versions.

In common with legacy spanning tree systems, the CIST protocol first determines its root bridge from all the bridges on the network. This is the bridge that contains the lowest bridge identifier. The protocol then selects a regional root bridge for each MSTR. This is the bridge that provides the best path to the CIST root. After the MSTR root bridges have been chosen, they then act on the region's behalf in such a way that the region appears to the Common Spanning Tree (CST) as a virtual bridge. So in addition to having multiple MSTIs, each region operates as a bridge in a CST.

CIST In addition to the individual MSTIs within each MSTP region, the MSTP region is a member of a network-wide spanning tree called the Common and Internal Spanning Tree (CIST). Conceptually, each region represents a virtual bridge. Internal and external bridge connectivity are two independent functions.

Frames with VIDs allocated to the CIST are subject to the rules and path costs of the complete bridged LAN as determined by the CIST's vectors. Frames other than these are subject to the CIST when travelling outside their region, and subject to its particular MSTI inside the region.

The following operational rules apply:

- Each bridge can be a member of only one region.
- A data frame is associated with a single VID.
- Data frames with a given VID are associated with either the CIST or their particular MSTI, but not both.

The role of the Common Spanning Tree (CST) in a network, and the Common and Internal Spanning Tree (CIST) configured on each device, is to prevent loops within a wider network that may span more than one MSTP region and parts of the network running in legacy STP or RSTP mode.

CIST first allocates root and designated bridges by selecting the bridge with the lowest identifier as the root. MSTP then deals with any loops between the regions in the CST. It does this by considering the CIST "vectors" in the following order:

1. CIST External Root Path Cost
2. CIST Regional Root Identifier
3. CIST Internal Root Path Cost
4. CIST Designated Bridge Identifier
5. CIST Designated Port Identifier
6. CIST Receiving Port Identifier

MSTP Bridge Protocol Data Units (BPDUs)

The main function of bridge protocol data units is to enable MSTP to select its root bridges for the CIST (“[Common and Internal Spanning Tree \(CIST\)](#)” on page 18.14) and each MSTI. MSTP is compatible with earlier spanning tree versions; its Bridge Protocol Data Unit (BPDU) formats build on earlier versions (“[Compatibility with Previous Spanning Tree Protocols](#)” on page 18.14).

[Table 18-7](#) shows the standardized format for MSTP BPDU messages. The general format of the BPDUs comprise a common generic portion—octets 1 to 36—that are based on those defined in IEEE Standard 802.1D, 1998, followed by components that are specific to CIST—octets 37 to 102. Components specific to each MSTI are added to this BPDU data block.

Table 18-7: MSTP Bridge Protocol Data Units (BPDUs)

Field Name	Octets	Description
Protocol Identifier	1–2	Protocol being used. The value 0000 0000 0000 0000 identifies the spanning tree algorithm and protocol.
Protocol Version Identifier	3	Identifies the protocol version used.
BPDU Type	4	Value 0000 0000 specifies a configuration BPDU.
CIST Flags	5	Bit 1 is the topology change flag. Bit 2 conveys the CIST proposal flag in RST and MST BPDUs - unused in STP. Bits 3 & 4 convey the CIST port role in RST, and MST BPDUs - unused in STP. Bit 5 conveys the CIST learning flag in RST and MST BPDUs - unused in STP. Bit 6 conveys the CIST forwarding flag in RST and MST BPDUs - unused in STP. Bit 7 conveys the CIST agreement flag in RST and MST BPDUs - unused in STP. Bit 8 conveys the topology change acknowledge flag in STP configuration BPDUs - unused in RSTP and MSTP BPDUs.
CIST Root Identifier	6–13	The Bridge identifier of the CIST Root
CIST External Path Cost	14–17	The path cost between MST regions from the transmitting bridge to the CIST root.
CIST Regional Root Identifier	18–25	ID of the current CIST regional root bridge.
CIST Port Identifier	26–27	CIST port identifier of the transmitting bridge port.
Message Age	28–29	Message age timer value.
Max Age	30–31	Timeout value to be used by all bridges in the bridged network. This value is set by the root. Some implementations of MSTP may choose not to use this value.
Hello Time	32–33	Time interval between the generation of configuration BPDUs by the root bridge.
Forward Delay	34–35	A timeout value used to ensure forward delay timer consistency when transferring a port to the forwarding state. It is also used for ageing filtering database dynamic entries following changes in the active topology.

Table 18-7: MSTP Bridge Protocol Data Units (BPDUs) (cont.)

Field Name	Octets	Description
Version 1 Length	36	Used to convey the Version 1 length. It is always transmitted as 0.
Version 3 Length	37–38	Used to convey the Version 3 length. It is the number of octets taken by the parameters that follow in the BPDU.
MST Configuration Identifier	39–89	An identifier comprising elements of the following: Format Selector Configuration Name Revision Level Configuration Digest.
CIST Internal Root Path Cost	90–93	Path cost to the CIST regional root.
CIST Bridge Identifier	94–101	CIST bridge identifier of the transmitting bridge.
CIST Remaining Hops	102	Remaining hops which limits the propagation and longevity of received spanning tree information for the CIST.
MSTI Configuration Messages (may be absent)	103–39 plus Version 3 Length	See Table 18-8 .

Table 18-8: MSTI configuration messages

Field Name	Octets	Description
MSTI Flags	1	Bits 1 through 8, convey the topology change flag, proposal flag, port role (two bits), Learning flag, forwarding flag, agreement flag, and master flag for this MSTI.
MSTI Regional Root Identifier	2–9	This includes the value of the MSTID for this configuration message encoded in bits 4 through 1 of octet 1, and bits 8 through 1 of octet 2.
MSTI Internal Root Path Cost	10-13	Internal Root Path Cost.
MSTI Bridge Priority	14	Bits 5 through 8 convey the value of the bridge identifier priority for this MSTI. Bits 1 through 4 of Octet 14 are transmitted as 0, and ignored on receipt.
MSTI Port Priority	15	Bits 5 through 8 are used to convey the value of the port identifier priority for this MSTI. Bits 1 through 4 are transmitted as 0, and ignored on receipt.
MSTI Remaining Hops	16	Value of remaining hops for this MSTI.

Configuring MSTP

By default, RSTP is enabled with default settings on all switch ports. To configure MSTP, see the configuration procedure in [Table 18-9](#).

To configure other modes, see “[Configuring RSTP](#)” on page 18.8 or “[Configuring STP](#)” on page 18.6.

For detailed configuration examples, see the How To Note *How To Configure Basic Switching Functionality*, available from website at <http://www.alliedtelesis.com>.

Configuration guidelines for MSTP

- Switches must have the same MST configuration identification elements (region name, revision level and VLAN to MSTI mapping) to be in the same MST region. When configuring multiple MST regions for MSTP, MSTIs are locally significant within an MST region. MSTIs will not span from one region to another region.
- Common and Internal Spanning Tree (CIST) is the default spanning tree instance for MSTP. This means that all VLANs that are not explicitly configured into another MSTI are members of the CIST.
- The software supports a single instance of the MSTP Algorithm consisting of the CIST and up to 15 MSTIs.
- A VLAN can only be mapped to one MSTI or to the CIST. One VLAN mapped to multiple spanning trees is not allowed. All the VLANs are mapped to the CIST by default. Once a VLAN is mapped to a specified MSTI, it is removed from the CIST.
- An MSTI is locally significant within an MST region. An MSTI cannot span across multiple MST regions. The CIST is the spanning tree instance for connecting different MST regions and single spanning tree entities, such as RSTP and STP switches.
- MSTP is compatible with RSTP and STP. An MST region appears as a virtual bridge connecting to single spanning tree entities.
- To avoid unnecessary STP processing, a port that attaches to a LAN that is known to have no other bridges/switches attached can be configured as an edge port.

Before configuring MSTP Before configuring MSTP, configure VLANs and associate them with switch ports ([Chapter 16, VLAN Introduction](#) and [Chapter 17, VLAN Commands](#)), and determine for your network:

- which MSTP regions, revision level and instances are required
- which VLANs and switch ports will belong to which MSTIs,
- which devices you want to be root bridges for each MSTI

Table 18-9: Configuration procedure for MSTP

Enable MSTP		
<code>awplus#</code>	<code>configure terminal</code>	Enter Configuration mode.
<code>awplus(config)#</code>	<code>spanning-tree mode mstp</code>	By default, the device is in RSTP mode. Change to MSTP mode.
<code>awplus(config)#</code>	<code>spanning-tree {mstp rstp stp} enable</code>	By default, spanning tree is enabled on all switch ports. If it has been disabled, enable it for MSTP.
Configure MSTP region, revision, and instances		
All MSTP devices in this region of the network must have the same region name, revision number, and VLAN to MSTI mappings.		
<code>awplus(config)#</code>	<code>spanning-tree mst configuration</code>	Enter MST Configuration mode.
<code>awplus(config-mst)#</code>	<code>region <region-name></code>	Specify the MSTP region. The region is an arbitrary string that specifies the name you want to assign to the MST region for identification.

Table 18-9: Configuration procedure for MSTP (cont.)

<code>awplus(config-mst)# revision <revision-number></code>	Specify the MSTP revision number <0-255>. The revision parameter specifies the revision of the current MST configuration. The revision is an arbitrary number that you assign to an MST region. It can be used to keep track of the number of times that MST configuration has been updated for the network.
<code>awplus(config-mst)# instance <msti-id> vlan {<vid> <vid-list>}</code>	To allow MSTP to block traffic for different VLANs in different places in a loop, create multiple MSTP instances and associate VLANs with them. Each VLAN can only be in one instance.

Advanced configuration

The commands above are the minimum required to configure MSTP. The following commands allow more advanced configuration.

Assign root bridge priorities

MSTP lets you distribute traffic more efficiently across a network by blocking different links for different VLANs. You do this by making different devices into the root bridge for each MSTP instance, and for the CIST, so that each instance blocks a different link. By default, all devices have the same root bridge priority, 32768 (8000 in hexadecimal), so the device with the lowest MAC address becomes the root bridge. If you want the device to be the root bridge for an instance or for the CIST, set the priority to a lower value (a higher priority) than other devices for this instance. (If you enter a number that is not a multiple of 4096, the device rounds the number down.)

<code>awplus(config-if)# spanning-tree mst configuration</code>	Enter MST Configuration mode.
<code>awplus(config-mst)# instance <msti-id> priority <priority></code>	Set the priority for the device to become the root bridge for each instance.
<code>awplus(config-mst)# exit</code>	Return to Global Configuration mode.
<code>awplus(config)# spanning-tree priority <priority></code>	Set the priority for the device to become the root bridge for the CIST.

Configure edge ports

If some switch ports are connected to devices that cannot generate BPDUs (such as workstations), you can set particular switch ports as edge ports, or set them to automatically detect whether they are edge ports.

<code>awplus(config-if)# interface (to configure) <port-list></code>	Enter Interface Configuration mode for these switch ports.
<code>awplus(config-if)# spanning-tree edgeport</code>	Set these ports to be edge ports,
<code>awplus(config-if)# or</code>	or
<code>spanning-tree autoedge</code>	to automatically detect whether they are edge ports.

Configure Root Guard

<code>awplus(config-if)# spanning-tree guard root</code>	The Root Guard feature makes sure that the port on which it is enabled is a designated port. If the Root Guard enabled port receives a superior BPDU, it goes to a Listening state (for STP) or discarding state (for RSTP and MSTP). Enable the Guard Root feature if required.
<code>awplus(config-if)# exit</code>	Return to Global Configuration mode.

Table 18-9: Configuration procedure for MSTP (cont.)

Configure BPDU Guard		
<code>awplus(config)#</code>	<code>spanning-tree portfast bpduguard</code>	If required, enable the BPDU Guard feature, and configure timeout parameters.
<code>awplus(config)#</code>	<code>spanning-tree errdisable-timeout enable</code>	
<code>awplus(config)#</code>	<code>spanning-tree errdisable-timeout interval <10-1000000></code>	
Check MSTP configuration		
<code>awplus(config)#</code>	<code>exit</code>	Return to Privileged Exec mode.
<code>awplus#</code>	<code>show spanning-tree mst config</code>	Check that the digest is the same on this device as for all other devices in the same region.
<code>awplus#</code>	<code>show spanning-tree mst</code>	Check the MST to VLAN and port mapping.
<code>awplus#</code>	<code>show spanning-tree mst instance <msti-id></code>	Check the detailed information for a particular instance, and all switch ports associated with that instance.
<code>awplus#</code>	<code>show spanning-tree [interface <port-list>]</code>	Check general information about MSTP, and the CIST settings.

Advanced configuration:

For most networks, the default settings of the following will be suitable. However, you can also configure them.

- path costs for ports in an MSTI (`spanning-tree mst instance path-cost`) or for the CIST (`spanning-tree path-cost`)
- port priority for ports in an MSTI (`spanning-tree mst instance priority`) or for the CIST (`spanning-tree priority (port priority)`)

Chapter 19: Spanning Tree Commands



Command List	19.2
clear spanning-tree detected protocols (RSTP and MSTP)	19.2
debug mstp (RSTP and STP)	19.3
instance priority (MSTP)	19.6
instance vlan (MSTP)	19.8
region (MSTP)	19.9
revision (MSTP)	19.10
show debugging mstp.....	19.11
show spanning-tree.....	19.12
show spanning-tree (brief)	19.15
show spanning-tree mst.....	19.16
show spanning-tree mst config	19.17
show spanning-tree mst detail.....	19.18
show spanning-tree mst detail interface.....	19.20
show spanning-tree mst instance.....	19.22
show spanning-tree mst instance interface	19.23
show spanning-tree mst interface	19.24
spanning-tree autoedge (RSTP and MSTP)	19.25
spanning-tree cisco-interoperability (MSTP)	19.26
spanning-tree edgeport (RSTP and MSTP).....	19.27
spanning-tree enable.....	19.28
spanning-tree errdisable-timeout enable.....	19.29
spanning-tree errdisable-timeout interval.....	19.30
spanning-tree force-version	19.31
spanning-tree forward-time	19.32
spanning-tree guard root.....	19.33
spanning-tree hello-time.....	19.34
spanning-tree link-type.....	19.35
spanning-tree max-age.....	19.36
spanning-tree max-hops (MSTP)	19.37
spanning-tree mode	19.38
spanning-tree mst configuration	19.38
spanning-tree mst instance	19.39
spanning-tree mst instance path-cost.....	19.40
spanning-tree mst instance priority.....	19.41
spanning-tree path-cost.....	19.42
spanning-tree portfast (STP)	19.43
spanning-tree portfast bpdu-filter	19.45
spanning-tree portfast bpdu-guard	19.47
spanning-tree priority (bridge priority)	19.48
spanning-tree priority (port priority)	19.49
spanning-tree transmit-holdcount	19.50
undebug mstp	19.50

Command List

This chapter provides an alphabetical reference for commands used to configure RSTP, STP or MSTP. For information about spanning trees, including configuration procedures, see [Chapter 18, Spanning Tree Introduction: STP, RSTP, and MSTP](#)

clear spanning-tree detected protocols (RSTP and MSTP)

Use this command to clear the detected protocols for a specific port, or all ports.

Use this command in RSTP or MSTP mode only.

Syntax `clear spanning-tree detected protocols [interface <port>]`

Parameter	Description
<port>	The port to clear detected protocols for. The port may be a switch port (e.g. <code>port1.1.4</code>), a static channel group (e.g. <code>sa3</code>), or a dynamic (LACP) channel group (e.g. <code>po4</code>).

Mode Privileged Exec

Example

```
awplus# clear spanning-tree detected protocols
```

debug mstp (RSTP and STP)

Use this command to enable debugging for the configured spanning tree mode, and echo data to the console, at various levels. Note that although this command uses the keyword **mstp** it displays debugging output for RSTP and STP protocols as well the MSTP protocol.

Use the **no** variant of this command to disable spanning tree debugging.

Syntax

```
debug mstp {all|cli|protocol [detail]|timer [detail]}
debug mstp {packet {rx|tx} [decode] [interface <interface>]}
debug mstp {topology-change [interface <interface>]}
no debug mstp {all|cli|protocol [detail]|timer [detail]}
no debug mstp {packet {rx|tx} [decode] [interface <interface>]}
no debug mstp {topology-change [interface <interface>]}
```

Parameter	Description
all	echoes all spanning tree debugging levels to the console.
cli	echoes spanning tree commands to the console.
packet	echoes spanning tree packets to the console.
rx	received packets.
tx	transmitted packets.
protocol	echoes protocol changes to the console.
timer	echoes timer information to the console.
detail	detailed output.
decode	interprets packet contents
topology-change	interprets topology change messages
interface	keyword before <interface> placeholder to specify an interface to debug
<interface>	placeholder used to specify the name of the interface to debug.

Mode Privileged Exec and Global Configuration mode

Usage 1 Use the **debug mstp topology-change interface** command to generate debugging messages when the switch receives an indication of a topology change in a BPDU from another device. The debugging can be activated on a per-port basis. Although this command uses the keyword **mstp**, it displays debugging output for RSTP and STP protocols as well as the MSTP protocol.

Due to the likely volume of output, these debug messages are best viewed using the [terminal monitor command on page 8.57](#) before issuing the relevant `debug mstp` command. The default terminal monitor filter will select and display these messages. Alternatively, the messages can be directed to any of the other log outputs by adding a filter for the MSTP application using [log buffered \(filter\) command on page 10.10](#)

```
awplus# configure terminal
awplus(config)# log buffered program mstp
```

Output 1

```
awplus#terminal monitor
awplus#debug mstp topology-change interface port1.0.19
10:09:09 awplus MSTP[1409]: Topology change rcvd on port1.0.19 (internal)
10:09:09 awplus MSTP[1409]: Topology change rcvd on MSTI 1 port1.0.19
aawplus#debug mstp topology-change interface port1.0.21
10:09:29 awplus MSTP[1409]: Topology change rcvd on port1.0.21 (external)
10:09:29 awplus MSTP[1409]: Topology change rcvd on MSTI 1 port1.0.21
```

Usage 2 Use the `debug mstp packet rx|tx decode interface` command to generate debugging messages containing the entire contents of a BPDU displayed in readable text for transmitted and received xSTP BPDUs. The debugging can be activated on a per-port basis and transmit and receive debugging is controlled independently. Although this command uses the keyword `mstp`, it displays debugging output for RSTP and STP protocols as well as the MSTP protocol.

Due to the likely volume of output, these debug messages are best viewed using the [terminal monitor command on page 8.57](#) before issuing the relevant `debug mstp` command. The default terminal monitor filter will select and display these messages. Alternatively, the messages can be directed to any of the other log outputs by adding a filter for the MSTP application using the [log buffered \(filter\) command on page 10.10](#):

```
awplus(config)# log buffered program mstp
```

Output 2 In MSTP mode - an MSTP BPDU with 1 MSTI:

```
awplus#terminal monitor
awplus#debug mstp packet rx decode interface port1.0.19
17:23:42 awplus MSTP[1417]: port1.0.19 xSTP BPDU rx - start
17:23:42 awplus MSTP[1417]: Protocol version: MSTP, BPDU type: RST
17:23:42 awplus MSTP[1417]: CIST Flags: Agree Forward Learn role=Desig
17:23:42 awplus MSTP[1417]: CIST root id      : 0000:0000cd1000fe
17:23:42 awplus MSTP[1417]: CIST ext pathcost : 0
17:23:42 awplus MSTP[1417]: CIST reg root id  : 0000:0000cd1000fe
17:23:42 awplus MSTP[1417]: CIST port id    : 8001 (128:1)
17:23:42 awplus MSTP[1417]: msg age: 0 max age: 20 hellotime: 2 fwd delay: 15
17:23:42 awplus MSTP[1417]: Version 3 length : 80
17:23:42 awplus MSTP[1417]: Format id       : 0
17:23:42 awplus MSTP[1417]: Config name    : test
17:23:42 awplus MSTP[1417]: Revision level : 0
17:23:42 awplus MSTP[1417]: Config digest  : 3ab68794d602fdf43b21c0b37ac3bca8
17:23:42 awplus MSTP[1417]: CIST int pathcost : 0
17:23:42 awplus MSTP[1417]: CIST bridge id  : 0000:0000cd1000fe
17:23:42 awplus MSTP[1417]: CIST hops remaining : 20
17:23:42 awplus MSTP[1417]: MSTI flags     : Agree Forward Learn role=Desig
17:23:42 awplus MSTP[1417]: MSTI reg root id  : 8001:0000cd1000fe
17:23:42 awplus MSTP[1417]: MSTI pathcost   : 0
17:23:42 awplus MSTP[1417]: MSTI bridge priority : 32768 port priority : 128
17:23:42 awplus MSTP[1417]: MSTI hops remaining : 20
17:23:42 awplus MSTP[1417]: port1.0.19 xSTP BPDU rx - finish
```

In STP mode transmitting a TCN BPDU:

```
awplus#terminal monitor
awplus#debug mstp packet tx decode interface port1.0.19
17:28:09 awplus MSTP[1417]: port1.0.19 xSTP BPDU tx - start
17:28:09 awplus MSTP[1417]: Protocol version: STP, BPDU type: TCN
17:28:09 awplus MSTP[1417]: port1.0.19 xSTP BPDU tx - finish
```

In STP mode receiving an STP BPDU:

```
awplus#terminal monitor
awplus#debug mstp packet rx decode interface port1.0.19
17:31:36 awplus MSTP[1417]: port1.0.19 xSTP BPDU rx - start
17:31:36 awplus MSTP[1417]: Protocol version: STP, BPDU type: Config
17:31:36 awplus MSTP[1417]: Flags: role=none
17:31:36 awplus MSTP[1417]: Root id      : 8000:0000cd1000fe
17:31:36 awplus MSTP[1417]: Root pathcost : 0
17:31:36 awplus MSTP[1417]: Bridge id   : 8000:0000cd1000fe
17:31:36 awplus MSTP[1417]: Port id     : 8001 (128:1)
17:31:36 awplus MSTP[1417]: msg age: 0 max age: 20 hellotime: 2 fwd delay: 15
17:31:36 awplus MSTP[1417]: ort1.0.19 xSTP BPDU rx - finish
```

In RSTP mode receiving an RSTP BPDU:

```
awplus#terminal monitor
awplus#debug mstp packet rx decode interface port1.0.19
awplus#17:30:17 awplus MSTP[1417]: port1.0.19 xSTP BPDU rx - start
17:30:17 awplus MSTP[1417]: Protocol version: RSTP, BPDU type: RST
17:30:17 awplus MSTP[1417]: CIST Flags: Forward Learn role=Desig
17:30:17 awplus MSTP[1417]: CIST root id      : 8000:0000cd1000fe
17:30:17 awplus MSTP[1417]: CIST ext pathcost : 0
17:30:17 awplus MSTP[1417]: CIST reg root id  : 8000:0000cd1000fe
17:30:17 awplus MSTP[1417]: CIST port id     : 8001 (128:1)
17:30:17 awplus MSTP[1417]: msg age: 0 max age: 20 hellotime: 2 fwd delay: 15
17:30:17 awplus MSTP[1417]: port1.0.19 xSTP BPDU rx - finish
```

Examples

```
awplus# debug mstp all

awplus# debug mstp cli

awplus# debug mstp packet rx

awplus# debug mstp protocol detail

awplus# debug mstp timer

awplus# debug mstp packet rx decode interface port1.0.2

awplus# debug mstp packet tx decode interface port1.0.12
```

Related commands [log buffered \(filter\)](#)
[show debugging mstp](#)
[terminal monitor](#)
[undebg mstp](#)

instance priority (MSTP)

Use this command to set the priority for this device to become the root bridge for the specified MSTI.

Use this command for MSTP only.

Use the **no** variant of this command to restore the root bridge priority of the device for the instance to the default.

Syntax `instance <msti-id> priority <priority>`
`no instance <msti-id> priority <priority>`

Parameter	Description
<code><msti-id></code>	The MST instance ID (1-15).
<code><priority></code>	<0-61440> Specify the root bridge priority for the device for the MSTI. A lower priority number indicates a greater likelihood of the device becoming the root bridge. The priority values can be set only in increments of 4096. If you specify a number that is not a multiple of 4096, it will be rounded down. Default: 32768

Default The default priority value for all instances is 32768.

Mode MST Configuration Mode

Usage MSTP lets you distribute traffic more efficiently across a network by blocking different links for different VLANs. You do this by making different devices into the root bridge for each MSTP instance, so that each instance blocks a different link.

If all devices have the same root bridge priority for the instance, MSTP selects the device with the lowest MAC address to be the root bridge. Give the device a higher priority for becoming the root bridge for a particular instance by assigning it a lower priority number, or vice versa.

Examples To set the root bridge priority for MSTP instance 2 to be the highest (0), so that it will be the root bridge for this instance when available, use the commands:

```
awplus# configure terminal
awplus(config)# spanning-tree mst configuration
awplus(config-mst)# instance 2 priority 0
```

To reset the root bridge priority for instance 2 to the default (32768), use the commands:

```
awplus# configure terminal
awplus(config)# spanning-tree mst configuration
awplus(config-mst)# no instance 2 priority
```

Related Commands region (MSTP)
 revision (MSTP)
 show spanning-tree mst config
 spanning-tree mst instance
 spanning-tree mst instance priority

instance vlan (MSTP)

Use this command to create an MST Instance (MSTI), and associate the specified VLANs with it. An MSTI is a spanning tree instance that exists within an MST region (MSTR). An MSTR can contain up to 15 MSTIs.

When a VLAN is associated with an MSTI the member ports of the VLAN are automatically configured to send and receive spanning-tree information for the associated MSTI. You can disable this automatic configuration of member ports of the VLAN to the associated MSTI by using a **no spanning-tree mst instance** command to remove the member port from the MSTI.

Use the **instance vlan** command for MSTP only.

Use the **no** variant of this command to remove the specified VLANs from the MSTI.

Syntax

```
instance <msti-id> vlan {<vid>|<vid-list>}
no instance <msti-id> vlan {<vid>|<vid-list>}
```

Parameter	Description
<msti-id>	Specify the MST instance ID (1-15).
<vid>	<1-4094> Specify a VLAN ID to be associated with the MSTI.
<vid-list>	A hyphen-separated range or a comma-separated list of VLAN IDs

Mode MST Configuration mode

Usage The VLANs must be created before being associated with an MST instance (MSTI). If the VLAN range is not specified, the MSTI will not be created.

This command removes the specified VLANs from the CIST and adds them to the specified MSTI. If you use the **no** variant of this command to remove the VLAN from the MSTI, it returns it to the CIST. To move a VLAN from one MSTI to another, you must first use the **no** variant of this command to return it to the CIST.

Ports in these VLANs will remain in the control of the CIST until you associate the ports with the MSTI using the **spanning-tree mst instance** command.

Example

```
awplus# configure terminal
awplus(config)# spanning-tree mode mstp
awplus(config)# spanning-tree mst configuration
awplus(config-mst)# instance 2 vlan 30
```

Related Commands

- region (MSTP)
- revision (MSTP)
- show spanning-tree mst config
- spanning-tree mst instance
- vlan

region (MSTP)

Use this command to assign a name to the device's MST Region. MST Instances (MSTI) of a region form different spanning trees for different VLANs.

Use this command for MSTP only.

Use the **no** variant of this command to remove this region name and reset it to the default.

Syntax `region <region-name>`
`no region`

Parameter	Description
<code><region-name></code>	Specify the name of the region, up to 32 characters. Valid characters are upper-case, lower-case, digits, underscore.

Default By default, the region name is My Name.

Mode MST Configuration mode

Usage The region name, the revision number, and the digest of the VLAN to MSTI configuration table must be the same on all devices that are intended to be in the same MST region.

Example

```
awplus# configure terminal
awplus(config)# spanning-tree mst configuration
awplus(config-mst)# region ATL
```

Related Commands `revision (MSTP)`
`show spanning-tree mst config`

revision (MSTP)

Use this command to specify the MST revision number to be used in the configuration identifier.

Use this command for MSTP only.

Syntax `revision <revision-number>`

Parameter	Description
<code><revision-number></code>	<0-255> Revision number.

Default The default value of revision number is 0.

Mode MST Configuration Mode

Usage The region name, the revision number, and the digest of the VLAN to MSTI configuration table must be the same on all devices that are intended to be in the same MST region.

Example

```
awplus# configure terminal
awplus(config)# spanning-tree mst configuration
awplus(config-mst)# revision 25
```

Related Commands [region \(MSTP\)](#)
[show spanning-tree mst config](#)
[instance vlan \(MSTP\)](#)

show debugging mstp

Use this command to show the MSTP debugging options set.

For information on output options, see [“Controlling “show” Command Output”](#) on page 1.35.

Syntax `show debugging mstp`

Mode Privileged Exec mode

Example To display the MSTP debugging options set, enter the command:

```
awplus# show debugging mstp
```

Output Figure 19-1: Example output from the `show debugging mstp` command

```
MSTP debugging status:  
MSTP receiving packet debugging is on
```

Related Commands `debug mstp (RSTP and STP)`

show spanning-tree

Use this command to display detailed spanning tree information on the specified port or on all ports. Use this command for RSTP, MSTP or STP.

For information on output options, see [“Controlling “show” Command Output” on page 1.35.](#)

Syntax `show spanning-tree [interface <port-list>]`

Parameter	Description
<code>interface</code>	Display information about the following port only.
<code><port-list></code>	The ports to display information about. A port-list can be: <ul style="list-style-type: none"> ■ a switch port (e.g. <code>port1.2.12</code>) a static channel group (e.g. <code>sa3</code>) or a dynamic (LACP) channel group (e.g. <code>po3</code>) ■ a continuous range of ports separated by a hyphen, e.g. <code>port1.0.1-1.0.24</code>, or <code>sa1-2</code>, or <code>po1-4</code> ■ a comma-separated list of ports and port ranges, e.g. <code>port1.0.1, port1.1.1-1.2.24</code>. Do not mix switch ports, static channel groups, and dynamic (LACP) channel groups in the same list.

Mode User Exec, Privileged Exec and Interface mode

Usage Note that any list of interfaces specified must not span any interfaces that are not installed.

A topology change counter has been included for RSTP and MSTP. You can see the topology change counter for RSTP by using the `show spanning-tree` command. You can see the topology change counter for MSTP by using the `show spanning-tree mst instance` command.

Example To display spanning tree information about `port1.0.23`, use the command:

```
awplus# show spanning-tree interface port1.0.23
```

Output Figure 19-2: Example output from the `show spanning-tree` command

```
% 1: Bridge up - Spanning Tree Enabled
% 1: Root Path Cost 0 - Root Port 0 - Bridge Priority 32768
% 1: Forward Delay 15 - Hello Time 2 - Max Age 20
% 1: Root Id 80000000cd20f093
% 1: Bridge Id 80000000cd20f093
% 1: last topology change Sun Nov 20 12:24:24 1977
% 1: portfast bpdu-filter disabled
% 1: portfast bpdu-guard disabled
% 1: portfast errdisable timeout disabled
% 1: portfast errdisable timeout interval 300 sec
%   port1.0.23: Port 5023 - Id 839f - Role Designated - State Forwarding
%   port1.0.23: Designated Path Cost 0
%   port1.0.23: Configured Path Cost 200000 - Add type Explicit ref count 1
%   port1.0.23: Designated Port Id 839f - Priority 128 -
%   port1.0.23: Root 80000000cd20f093
%   port1.0.23: Designated Bridge 80000000cd20f093
%   port1.0.23: Message Age 0 - Max Age 20
%   port1.0.23: Hello Time 2 - Forward Delay 15
%   port1.0.23: Forward Timer 0 - Msg Age Timer 0 - Hello Timer 1 - topo change
timer 0
%   port1.0.23: forward-transitions 32
%   port1.0.23: Version Rapid Spanning Tree Protocol - Received None - Send RSTP
%   port1.0.23: No portfast configured - Current portfast off
%   port1.0.23: portfast bpdu-guard default - Current portfast bpdu-guard off
%   port1.0.23: portfast bpdu-filter default - Current portfast bpdu-filter off
%   port1.0.23: no root guard configured - Current root guard off
%   port1.0.23: Configured Link Type point-to-point - Current point-to-point
```

The following example output is for the `show spanning-tree` command in RSTP mode.

Figure 19-3: Example output from the `show spanning-tree` command

```
awplus#show spanning-tree
% 1: Bridge up - Spanning Tree Enabled
% 1: Root Path Cost 0 - Root Port 0 - Bridge Priority 32768
% 1: Forward Delay 15 - Hello Time 2 - Max Age 20
% 1: Root Id 80000000cd24ff2d
% 1: Bridge Id 80000000cd24ff2d
% 1: last topology change Thu Jul 26 02:06:26 2007
% 1: portfast bpdu-filter disabled
% 1: portfast bpdu-guard disabled
% 1: portfast errdisable timeout disabled
% 1: portfast errdisable timeout interval 300 sec
%   port1.0.1: Port 5001 - Id 8389 - Role Disabled - State Discarding
%   port1.0.1: Designated Path Cost 0
%   port1.0.1: Configured Path Cost 20000000 - Add type Explicit ref count 1
%   port1.0.1: Designated Port Id 8389 - Priority 128 -
%   port1.0.1: Root 80000000cd24ff2d
%   port1.0.1: Designated Bridge 80000000cd24ff2d
%   port1.0.1: Message Age 0 - Max Age 20
%   port1.0.1: Hello Time 2 - Forward Delay 15
%   port1.0.1: Forward Timer 0 - Msg Age Timer 0 - Hello Timer 0 - topo change timer
0
%   port1.0.1: forward-transitions 0
%   port1.0.1: Version Rapid Spanning Tree Protocol - Received None - Send STP
%   port1.0.1: No portfast configured - Current portfast off
%   port1.0.1: portfast bpdu-guard default - Current portfast bpdu-guard off
%   port1.0.1: portfast bpdu-filter default - Current portfast bpdu-filter off
%   port1.0.1: no root guard configured - Current root guard off
%   port1.0.1: Configured Link Type point-to-point - Current shared
%
%   port1.0.2: Port 5002 - Id 838a - Role Disabled - State Discarding
%   port1.0.2: Designated Path Cost 0
%   port1.0.2: Configured Path Cost 20000000 - Add type Explicit ref count 1
%   port1.0.2: Designated Port Id 838a - Priority 128 -
%   port1.0.2: Root 80000000cd24ff2d
%   port1.0.2: Designated Bridge 80000000cd24ff2d
%   port1.0.2: Message Age 0 - Max Age 20
%   port1.0.2: Hello Time 2 - Forward Delay 15
%   port1.0.2: Forward Timer 0 - Msg Age Timer 0 - Hello Timer 0 - topo change timer
0
%   port1.0.2: forward-transitions 0
%   port1.0.2: Version Rapid Spanning Tree Protocol - Received None - Send STP
%   port1.0.2: No portfast configured - Current portfast off
%   port1.0.2: portfast bpdu-guard default - Current portfast bpdu-guard off
%   port1.0.2: portfast bpdu-filter default - Current portfast bpdu-filter off
%   port1.0.2: no root guard configured - Current root guard off
%   port1.0.2: Configured Link Type point-to-point - Current shared
%
```

show spanning-tree (brief)

Use this command to display a summary of spanning tree status information on all ports. Use this command for RSTP, MSTP or STP

Syntax `show spanning-tree brief`

Parameter	Description
brief	A brief summary (of spanning tree information).

Mode User Exec, Privileged Exec and Interface Configuration

Usage Note that any list of interfaces specified must not span any interfaces that are not installed.

A topology change counter has been included for RSTP and MSTP. You can see the topology change counter for RSTP by using the `show spanning-tree` command. You can see the topology change counter for MSTP by using the `show spanning-tree mst instance` command.

Example To display a summary of spanning tree status information, use the command:

```
awplus# show spanning-tree brief
```

Output Figure 19-4: Example output from the `show spanning-tree brief` command

```
Default: Bridge up - Spanning Tree Enabled
Default: Root Path Cost 40000 - Root Port 4501 - Bridge Priority 32768
Default: Root Id 8000:0000cd250001
Default: Bridge Id 8000:0000cd296eb1

Port          Designated Bridge   Port Id   Role           State
sal           8000:001577c9744b  8195     Rootport      Forwarding
po1           8000:0000cd296eb1  81f9     Designated    Forwarding
port1.0.1    8000:0000cd296eb1  8389     Disabled      Discarding
port1.0.2    8000:0000cd296eb1  838a     Disabled      Discarding
port1.0.3    8000:0000cd296eb1  838b     Disabled      Discarding
port1.0.4    8000:0000cd296eb1  838c     Disabled      Discarding
port1.0.5    8000:0000cd296eb1  838d     Disabled      Discarding
port1.0.6    8000:0000cd296eb1  838e     Disabled      Discarding
port1.0.9    8000:0000cd296eb1  8391     Disabled      Discarding
port1.0.10   8000:0000cd296eb1  8392     Disabled      Discarding
port1.0.11   8000:0000cd296eb1  8393     Disabled      Discarding
port1.0.12   8000:0000cd296eb1  8394     Disabled      Discarding%
```

Related Commands `show spanning-tree`

show spanning-tree mst

This command displays bridge-level information about the CIST and VLAN to MSTI mappings.

For information on output options, see [“Controlling “show” Command Output” on page 1.35.](#)

Syntax `show spanning-tree mst`

Mode User Exec, Privileged Exec and Interface Configuration

Example To display bridge-level information about the CIST and VLAN to MSTI mappings, enter the command:

```
awplus# show spanning-tree mst
```

Output [Figure 19-5: Example output from the `show spanning-tree mst` command](#)

```
% 1: Bridge up - Spanning Tree Enabled
% 1: CIST Root Path Cost 0 - CIST Root Port 0 - CIST Bridge
Priority 32768
% 1: Forward Delay 15 - Hello Time 2 - Max Age 20 - Max-hops 20
% 1: CIST Root Id 8000000475e93ffe
% 1: CIST Reg Root Id 8000000475e93ffe
% 1: CST Bridge Id 8000000475e93ffe
% 1: portfast bpdu-filter disabled
% 1: portfast bpdu-guard disabled
% 1: portfast errdisable timeout disabled
% 1: portfast errdisable timeout interval 300 sec
%
% Instance      VLAN
% 0:            1
% 2:            4
```

Related Commands [show spanning-tree mst interface](#)

show spanning-tree mst config

Use this command to display MSTP configuration identifier for the device.

For information on output options, see [“Controlling “show” Command Output” on page 1.35.](#)

Syntax show spanning-tree mst config

Mode User Exec, Privileged Exec and Interface Configuration

Usage The region name, the revision number, and the digest of the VLAN to MSTI configuration table must be the same on all devices that are intended to be in the same MST region.

Example To display MSTP configuration identifier information, enter the command:

```
awplus# show spanning-tree mst config
```

Output Figure 19-6: Example output from the **show spanning-tree mst config** command

```
awplus#show spanning-tree mst config
%
% MSTP Configuration Information:
%-----
% Format Id       : 0
% Name           : My Name
% Revision Level  : 0
% Digest         : 0x80DEE46DA92A98CF21C603291B22880A
%-----
```

Related Commands instance vlan (MSTP)
region (MSTP)
revision (MSTP)

show spanning-tree mst detail

This command displays detailed information about each instance, and all interfaces associated with that particular instance.

For information on output options, see [“Controlling “show” Command Output” on page 1.35.](#)

Syntax `show spanning-tree mst detail`

Mode User Exec, Privileged Exec and Interface Configuration

Example To display detailed information about each instance, and all interfaces associated with them, enter the command:

```
awplus# show spanning-tree mst detail
```

Output Figure 19-7: Example output from the `show spanning-tree mst detail` command

```

% 1: Bridge up - Spanning Tree Enabled
% 1: CIST Root Path Cost 0 - CIST Root Port 0 - CIST Bridge Priority 32768
% 1: Forward Delay 15 - Hello Time 2 - Max Age 20 - Max-hops 20
% 1: CIST Root Id 80000000cd24ff2d
% 1: CIST Reg Root Id 80000000cd24ff2d
% 1: CIST Bridge Id 80000000cd24ff2d
% 1: portfast bpdu-filter disabled
% 1: portfast bpdu-guard disabled
% 1: portfast errdisable timeout disabled
% 1: portfast errdisable timeout interval 300 sec
% port1.0.1: Port 5001 - Id 8389 - Role Disabled - State Discarding
% port1.0.1: Designated External Path Cost 0 -Internal Path Cost 0
% port1.0.1: Configured Path Cost 20000000 - Add type Explicit ref count 1
% port1.0.1: Designated Port Id 8389 - CIST Priority 128 -
% port1.0.1: CIST Root 80000000cd24ff2d
% port1.0.1: Regional Root 80000000cd24ff2d
% port1.0.1: Designated Bridge 80000000cd24ff2d
% port1.0.1: Message Age 0 - Max Age 20
% port1.0.1: CIST Hello Time 2 - Forward Delay 15
% port1.0.1: CIST Forward Timer 0 - Msg Age Timer 0 - Hello Timer 0 - topo change
timer 0
% port1.0.1: forward-transitions 0
% port1.0.1: Version Multiple Spanning Tree Protocol - Received None - Send STP
% port1.0.1: No portfast configured - Current portfast off
% port1.0.1: portfast bpdu-guard default - Current portfast bpdu-guard off
% port1.0.1: portfast bpdu-filter default - Current portfast bpdu-filter off
% port1.0.1: no root guard configured - Current root guard off
% port1.0.1: Configured Link Type point-to-point - Current shared
%
% port1.0.2: Port 5002 - Id 838a - Role Disabled - State Discarding
% port1.0.2: Designated External Path Cost 0 -Internal Path Cost 0
% port1.0.2: Configured Path Cost 20000000 - Add type Explicit ref count 1
% port1.0.2: Designated Port Id 838a - CIST Priority 128 -
% port1.0.2: CIST Root 80000000cd24ff2d
% port1.0.2: Regional Root 80000000cd24ff2d
% port1.0.2: Designated Bridge 80000000cd24ff2d
% port1.0.2: Message Age 0 - Max Age 20
% port1.0.2: CIST Hello Time 2 - Forward Delay 15
% port1.0.2: CIST Forward Timer 0 - Msg Age Timer 0 - Hello Timer 0 - topo change
timer 0
% port1.0.2: forward-transitions 0
% port1.0.2: Version Multiple Spanning Tree Protocol - Received None - Send STP
% port1.0.2: No portfast configured - Current portfast off
% port1.0.2: portfast bpdu-guard default - Current portfast bpdu-guard off
% port1.0.2: portfast bpdu-filter default - Current portfast bpdu-filter off
% port1.0.2: no root guard configured - Current root guard off
% port1.0.2: Configured Link Type point-to-point - Current shared
%
% port1.0.3: Port 5003 - Id 838b - Role Disabled - State Discarding
% port1.0.3: Designated External Path Cost 0 -Internal Path Cost 0
% port1.0.3: Configured Path Cost 20000000 - Add type Explicit ref count 1
% port1.0.3: Designated Port Id 838b - CIST Priority 128 -
% port1.0.3: CIST Root 80000000cd24ff2d
% port1.0.3: Regional Root 80000000cd24ff2d
% port1.0.3: Designated Bridge 80000000cd24ff2d
% port1.0.3: Message Age 0 - Max Age 20
% port1.0.3: CIST Hello Time 2 - Forward Delay 15
% port1.0.3: CIST Forward Timer 0 - Msg Age Timer 0 - Hello Timer 0 - topo change
timer 0
% port1.0.3: forward-transitions 0
% port1.0.3: Version Multiple Spanning Tree Protocol - Received None - Send STP
% port1.0.3: No portfast configured - Current portfast off
% port1.0.3: portfast bpdu-guard default - Current portfast bpdu-guard off
% port1.0.3: portfast bpdu-filter default - Current portfast bpdu-filter off
% port1.0.3: no root guard configured - Current root guard off
% port1.0.3: Configured Link Type point-to-point - Current shared

```

show spanning-tree mst detail interface

This command prints detailed information about the specified switch port, and the MST instances associated with it.

For information on output options, see [“Controlling “show” Command Output” on page 1.35.](#)

Syntax `show spanning-tree mst detail interface <port>`

Parameter	Description
<port>	The port to display information about. The port may be a switch port (e.g. port1.1.4), a static channel group (e.g. sa3), or a dynamic (LACP) channel group (e.g. po4).

Mode User Exec, Privileged Exec and Interface Configuration

Example To display detailed information about port1.1.3 and the instances associated with it, enter the command:

```
awplus# show spanning-tree mst detail interface port1.0.2
```

Output Figure 19-8: Example output from the `show spanning-tree mst detail interface` command

```
% 1: Bridge up - Spanning Tree Enabled
% 1: CIST Root Path Cost 0 - CIST Root Port 0 - CIST Bridge Priority 32768
% 1: Forward Delay 15 - Hello Time 2 - Max Age 20 - Max-hops 20
% 1: CIST Root Id 80000000cd24ff2d
% 1: CIST Reg Root Id 80000000cd24ff2d
% 1: CIST Bridge Id 80000000cd24ff2d
% 1: portfast bpdu-filter disabled
% 1: portfast bpdu-guard disabled
% 1: portfast errdisable timeout disabled
% 1: portfast errdisable timeout interval 300 sec
% port1.0.2: Port 5002 - Id 838a - Role Disabled - State Discarding
% port1.0.2: Designated External Path Cost 0 -Internal Path Cost 0
% port1.0.2: Configured Path Cost 20000000 - Add type Explicit ref count 2
% port1.0.2: Designated Port Id 838a - CIST Priority 128 -
% port1.0.2: CIST Root 80000000cd24ff2d
% port1.0.2: Regional Root 80000000cd24ff2d
% port1.0.2: Designated Bridge 80000000cd24ff2d
% port1.0.2: Message Age 0 - Max Age 20
% port1.0.2: CIST Hello Time 2 - Forward Delay 15
% port1.0.2: CIST Forward Timer 0 - Msg Age Timer 0 - Hello Timer 0 - topo change
timer 0
% port1.0.2: forward-transitions 0
% port1.0.2: Version Multiple Spanning Tree Protocol - Received None - Send STP
% port1.0.2: No portfast configured - Current portfast off
% port1.0.2: portfast bpdu-guard default - Current portfast bpdu-guard off
% port1.0.2: portfast bpdu-filter default - Current portfast bpdu-filter off
% port1.0.2: no root guard configured - Current root guard off
% port1.0.2: Configured Link Type point-to-point - Current shared
%
% Instance 2: Vlans: 2
% 1: MSTI Root Path Cost 0 -MSTI Root Port 0 - MSTI Bridge Priority 32768
% 1: MSTI Root Id 80020000cd24ff2d
% 1: MSTI Bridge Id 80020000cd24ff2d
% port1.0.2: Port 5002 - Id 838a - Role Disabled - State Discarding
% port1.0.2: Designated Internal Path Cost 0 - Designated Port Id 838a
% port1.0.2: Configured Internal Path Cost 20000000
% port1.0.2: Configured CST External Path cost 20000000
% port1.0.2: CST Priority 128 - MSTI Priority 128
% port1.0.2: Designated Root 80020000cd24ff2d
% port1.0.2: Designated Bridge 80020000cd24ff2d
% port1.0.2: Message Age 0 - Max Age 0
% port1.0.2: Hello Time 2 - Forward Delay 15
% port1.0.2: Forward Timer 0 - Msg Age Timer 0 - Hello Timer 0
```

show spanning-tree mst instance

This command displays detailed information for the specified instance, and all switch ports associated with that instance.

A topology change counter has been included for RSTP and MSTP. You can see the topology change counter for RSTP by using the [show spanning-tree](#) command. You can see the topology change counter for MSTP by using the [show spanning-tree mst instance](#) command.

For information on output options, see ["Controlling "show" Command Output" on page 1.35.](#)

Syntax `show spanning-tree mst instance <msti-id>`

Parameter	Description
<code><msti-id></code>	Specify the MST instance ID for which information needs to be displayed.

Mode User Exec, Privileged Exec, and Interface Configuration

Usage To display detailed information for **instance 2**, and all switch ports associated with that instance, use the command:

```
awplus# show spanning-tree mst instance 2
```

Output [Figure 19-9: Example output from the show spanning-tree mst instance command](#)

```
% 1: MSTI Root Path Cost 0 - MSTI Root Port 0 - MSTI Bridge Priority 32768
% 1: MSTI Root Id 80020000cd24ff2d
% 1: MSTI Bridge Id 80020000cd24ff2d
% port1.0.2: Port 5002 - Id 838a - Role Disabled - State Discarding
% port1.0.2: Designated Internal Path Cost 0 - Designated Port Id 838a
% port1.0.2: Configured Internal Path Cost 20000000
% port1.0.2: Configured CST External Path cost 20000000
% port1.0.2: CST Priority 128 - MSTI Priority 128
% port1.0.2: Designated Root 80020000cd24ff2d
% port1.0.2: Designated Bridge 80020000cd24ff2d
% port1.0.2: Message Age 0 - Max Age 0
% port1.0.2: Hello Time 2 - Forward Delay 15
% port1.0.2: Forward Timer 0 - Msg Age Timer 0 - Hello Timer 0
%
```

show spanning-tree mst instance interface

This command displays detailed information for the specified instance, and the specified switch port associated with that instance.

For information on output options, see [“Controlling “show” Command Output” on page 1.35.](#)

Syntax `show spanning-tree mst instance <1-15> interface <port>`

Parameter	Description
<code><port></code>	The port to display information about. The port may be a switch port (e.g. <code>port1.1.4</code>), a static channel group (e.g. <code>sa3</code>), or a dynamic (LACP) channel group (e.g. <code>po4</code>).

Mode User Exec, Privileged Exec, and Interface Configuration

Example To display detailed information for **instance 2**, interface **port1.0.2**, use the command

```
awplus# show spanning-tree mst instance2 interface port1.0.2
```

Output [Figure 19-10: Example output from the show spanning-tree mst instance command](#)

```
% 1: MSTI Root Path Cost 0 - MSTI Root Port 0 - MSTI Bridge Priority 32768
% 1: MSTI Root Id 80020000cd24ff2d
% 1: MSTI Bridge Id 80020000cd24ff2d
% port1.0.2: Port 5002 - Id 838a - Role Disabled - State Discarding
% port1.0.2: Designated Internal Path Cost 0 - Designated Port Id 838a
% port1.0.2: Configured Internal Path Cost 20000000
% port1.0.2: Configured CST External Path cost 20000000
% port1.0.2: CST Priority 128 - MSTI Priority 128
% port1.0.2: Designated Root 80020000cd24ff2d
% port1.0.2: Designated Bridge 80020000cd24ff2d
% port1.0.2: Message Age 0 - Max Age 0
% port1.0.2: Hello Time 2 - Forward Delay 15
% port1.0.2: Forward Timer 0 - Msg Age Timer 0 - Hello Timer 0
%
```

show spanning-tree mst interface

This command displays the number of instances created, and VLANs associated with it for the specified switch port.

For information on output options, see [“Controlling “show” Command Output” on page 1.35.](#)

Syntax `show spanning-tree mst interface <port>`

Parameter	Description
<port>	The port to display information about. The port may be a switch port (e.g. <code>port1.1.4</code>), a static channel group (e.g. <code>sa3</code>), or a dynamic (LACP) channel group (e.g. <code>po4</code>).

Mode User Exec, Privileged Exec, and Interface Configuration

Example To display detailed information about each instance, and all interfaces associated with them, for `port1.1.4`, use the command:

```
awplus# show spanning-tree mst interface port1.1.4
```

Output [Figure 19-11: Example output from the show spanning-tree mst interface command](#)

```
% 1: Bridge up - Spanning Tree Enabled
% 1: CIST Root Path Cost 0 - CIST Root Port 0 - CIST Bridge Priority 32768
% 1: Forward Delay 15 - Hello Time 2 - Max Age 20 - Max-hops 20
% 1: CIST Root Id 80000008c73a2b22
% 1: CIST Reg Root Id 80000008c73a2b22
% 1: CST Bridge Id 80000008c73a2b22
% 1: portfast bpdu-filter disabled
% 1: portfast bpdu-guard disabled
% 1: portfast errdisable timeout disabled
% 1: portfast errdisable timeout interval 1 sec
%
% Instance      VLAN
% 0:            1
% 1:            2-3
% 2:            4-5
```

spanning-tree autoedge (RSTP and MSTP)

Use this command to enable the autoedge feature on the port.

The autoedge feature allows the port to automatically detect that it is an edge port. If it does not receive any BPDUs in the first three seconds after linkup, enabling, or entering RSTP or MSTP mode, it sets itself to be an edgeport and enters the forwarding state.

Use this command for RSTP or MSTP.

Use the **no** variant of this command to disable this feature.

Syntax `spanning-tree autoedge`
`no spanning-tree autoedge`

Default Disabled.

Mode Interface Configuration

Example

```
awplus# configure terminal
awplus(config)# interface port1.1.3
awplus(config-if)# spanning-tree autoedge
```

Related commands [spanning-tree edgeport \(RSTP and MSTP\)](#)

spanning-tree cisco-interoperability (MSTP)

Use this command to enable/disable Cisco-interoperability for MSTP.

Use this command for MSTP only.

Syntax `spanning-tree cisco-interoperability {enable|disable}`

Parameter	Description
enable	Enable Cisco interoperability for MSTP.
disable	Disable Cisco interoperability for MSTP.

Default If this command is not used, Cisco interoperability is disabled.

Mode Global Configuration

Usage For compatibility with certain Cisco devices, all devices in the switched LAN running the AlliedWare Plus™ Operating System must have Cisco-interoperability enabled. When the AlliedWare Plus™ Operating System is interoperating with Cisco, the only criteria used to classify a region are the region name and revision level. VLAN to instance mapping is not used to classify regions when interoperating with Cisco.

Examples To enable Cisco interoperability on a Layer-2 switch:

```
awplus# configure terminal
awplus(config)# spanning-tree cisco-interoperability enable
```

To disable Cisco interoperability on a Layer-2 switch:

```
awplus# configure terminal
awplus(config)# spanning-tree cisco-interoperability disable
```

spanning-tree edgeport (RSTP and MSTP)

Use this command to set a port as an edge-port.

Use this command for RSTP or MSTP.

This command has the same effect as the [spanning-tree portfast \(STP\)](#) command, but the configuration displays differently in the output of some show commands.

Use the **no** variant of this command to set a port to its default state (not an edge-port).

Syntax `spanning-tree edgeport`
`no spanning-tree edgeport`

Default Not an edge port.

Mode Interface Configuration

Usage Use this command on a switch port connected to a LAN that has no other bridges attached. If a BPDU is received on the port that indicates that another bridge is connected to the LAN, then the port is no longer treated as an edge port.

Example

```
awplus# configure terminal
awplus(config)# interface port1.1.2
awplus(config-if)# spanning-tree edgeport
```

Related commands [spanning-tree autoedge \(RSTP and MSTP\)](#)

spanning-tree enable

Use this command to enable the specified spanning tree protocol on the device. Note that this must be the spanning tree protocol that is configured on the device by the [spanning-tree mode](#) command.

Use the **no** variant of this command to disable the configured spanning tree protocol. This places all ports in the forwarding state.

Syntax `spanning-tree {mstp|rstp|stp} enable`
`no spanning-tree {mstp|rstp|stp} enable`

Parameter	Description
mstp	Enables or disables MSTP
rstp	Enables or disables RSTP
stp	Enables or disables STP

Default The configured spanning tree mode is enabled by default.

Mode Global Configuration

Usage With no configuration, spanning tree is enabled, and the spanning tree mode is set to RSTP. To change the mode, see [spanning-tree mode command on page 19.38](#).

Examples

```
awplus# configure terminal
awplus(config)# spanning-tree mstp enable

awplus# configure terminal
awplus(config)# no spanning-tree mstp enable
```

Related commands [spanning-tree mode](#)

spanning-tree errdisable-timeout enable

Use this command to enable the errdisable-timeout facility, which sets a timeout for ports that are disabled due to the BPDU guard feature.

Use this command for RSTP or MSTP.

Use the **no** variant of this command to disable the errdisable-timeout facility.

Syntax `spanning-tree errdisable-timeout enable`
`no spanning-tree errdisable-timeout enable`

Default By default, the errdisable-timeout is disabled.

Mode Global Configuration

Usage The BPDU guard feature shuts down the port on receiving a BPDU on a BPDU-guard enabled port. This command associates a timer with the feature such that the port is re-enabled without manual intervention after a set interval. This interval can be configured by the user using the [spanning-tree errdisable-timeout interval](#) command.

Example

```
awplus# configure terminal
awplus(config)# spanning-tree errdisable-timeout enable
```

Related Commands [show spanning-tree](#)
[spanning-tree errdisable-timeout interval](#)
[spanning-tree portfast bpdu-guard](#)

spanning-tree errdisable-timeout interval

Use this command to specify the time interval after which a port is brought back up when it has been disabled by the BPDU guard feature.

Use this command for RSTP or MSTP.

Syntax `spanning-tree errdisable-timeout interval <10-1000000>`
`no spanning-tree errdisable-timeout interval`

Parameter	Description
<code><10-1000000></code>	Specify the errdisable-timeout interval in seconds.

Default By default, the port is re-enabled after 300 seconds.

Mode Global Configuration

Example

```
awplus# configure terminal
awplus(config)# spanning-tree errdisable-timeout interval 34
```

Related Commands `show spanning-tree`
`spanning-tree errdisable-timeout enable`
`spanning-tree portfast bpdu-guard`

spanning-tree force-version

Use this command to force the protocol version for the switch port. Use this command for RSTP or MSTP only.

Syntax `spanning-tree force-version <version>`
`no spanning-tree force-version`

Parameter	Description
<code><version></code>	<p><0-3> Version identifier.</p> <p>0 - Forces the port to operate in STP mode</p> <p>1 - Not supported</p> <p>2 - Forces the port to operate in RSTP mode. If it receives STP BPDUs, it can automatically revert to STP mode.</p> <p>3 - Forces the port to operate in MSTP mode (this option is only available if MSTP mode is configured.) If it receives RSTP or STP BPDUs, it can automatically revert to RSTP or STP mode.</p>

Default By default, no version is forced for the port. The port is in the spanning tree mode configured for the device, or a lower version if it automatically detects one.

Mode Interface Configuration

Examples Set the value to enforce the spanning tree protocol (STP):

```
awplus# configure terminal
awplus(config)# interface port1.1.2
awplus(config-if)# spanning-tree force-version 0
```

Set the default protocol version:

```
awplus# configure terminal
awplus(config)# interface port1.1.2
awplus(config-if)# no spanning-tree force-version
```

Related Commands [show spanning-tree](#)

spanning-tree forward-time

Use this command to set the forward delay.

The **forward delay** sets the time (in seconds) to control how fast a port changes its spanning tree state when moving towards the forwarding state. If the mode is set to STP, the value determines how long the port stays in each of the listening and learning states which precede the forwarding state. If the mode is set to RSTP or MSTP, this value determines the maximum time taken to transition from discarding to learning and from learning to forwarding.

This value is used only when the switch is acting as the root bridge. Switches not acting as the Root Bridge use a dynamic value for the **forward delay** set by the root bridge. The **forward delay**, **max-age**, and **hello time** parameters are interrelated.

Syntax `spanning-tree forward-time <forward-delay>`
`no spanning-tree forward-time`

Parameter	Description
<code><forward-delay></code>	<code><4-30></code> the forwarding time delay in seconds.

Default The default value is 15 seconds.

Mode Global Configuration

Usage The allowable range for forward-time is 4-30 seconds.

The **forward delay**, **max-age**, and **hello time** parameters should be set according to the following formulae, as specified in IEEE Standard 802.1d:

$$2 \times (\text{forward delay} - 1.0 \text{ seconds}) \geq \text{max-age}$$

$$\text{max-age} \geq 2 \times (\text{hello time} + 1.0 \text{ seconds})$$

Example

```
awplus# configure terminal
awplus(config)# spanning-tree forward-time 6
```

Related Commands `show spanning-tree`
`spanning-tree forward-time <forward-delay>`
`spanning-tree hello-time <hello-time>`
`spanning-tree mode`

spanning-tree guard root

Use this command to enable the Root Guard feature for the port. The root guard feature disables reception of superior BPDUs.

Use this command for RSTP, STP or MSTP.

Use the **no** variant of this command to disable the root guard feature for the port.

Syntax `spanning-tree guard root`
`no spanning-tree guard root`

Mode Interface Configuration

Usage The Root Guard feature makes sure that the port on which it is enabled is a designated port. If the Root Guard enabled port receives a superior BPDU, it goes to a Listening state (for STP) or discarding state (for RSTP and MSTP).

Example

```
awplus# configure terminal
awplus(config)# interface port1.1.2
awplus(config-if)# spanning-tree guard root
```

spanning-tree hello-time

Use this command to set the hello-time. This sets the time in seconds between the transmission of switch spanning tree configuration information when the switch is the Root Bridge of the spanning tree or is trying to become the Root Bridge.

Use this command for RSTP, STP or MSTP.

Use the **no** variant of this command to restore the default value of the hello time.

Syntax `spanning-tree hello-time <hello-time>`
`no spanning-tree hello-time`

Parameter	Description
<code><hello-time></code>	<code><1-10></code> The hello BPDU interval in seconds.

Default Default value is 2 seconds.

Mode Global Configuration

Usage The allowable range of values is 1-10 seconds.

The **forward delay**, **max-age**, and **hello time** parameters should be set according to the following formulae, as specified in IEEE Standard 802.1d:

$2 \times (\text{forward delay} - 1.0 \text{ seconds}) \geq \text{max-age}$

$\text{max-age} \geq 2 \times (\text{hello time} + 1.0 \text{ seconds})$

Example

```
awplus# configure terminal
awplus(config)# spanning-tree hello-time 3
```

Related Commands `spanning-tree forward-time <forward-delay>`
`spanning-tree max-age <max-age>`
`show spanning-tree`

spanning-tree link-type

Use this command to enable or disable point-to-point or shared link types on the switch port.

Use this command for RSTP or MSTP only.

Use the **no** variant of this command to return the port to the default link type.

Syntax `spanning-tree link-type {point-to-point|shared}`
`no spanning-tree link-type`

Parameter	Description
<code>shared</code>	Disable rapid transition.
<code>point-to-point</code>	Enable rapid transition.

Default The default link type is point-to-point.

Mode Interface Configuration

Usage You may want to set link type to shared if the port is connected to a hub with multiple switches connected to it.

Examples

```
awplus# configure terminal
awplus(config)# interface port1.1.3
awplus(config-if)# spanning-tree link-type point-to-point
```

spanning-tree max-age

Use this command to set the max-age. This sets the maximum age, in seconds, that dynamic spanning tree configuration information is stored in the switch before it is discarded.

Use this command for RSTP, STP or MSTP.

Use the **no** variant of this command to restore the default value of max-age.

Syntax `spanning-tree max-age <max-age>`
`no spanning-tree max-age`

Parameter	Description
<code><max-age></code>	<code><6-40></code> The maximum time, in seconds.

Default The default value of spanning-tree max-age is 20 seconds.

Mode Global Configuration

Usage Max-age is the maximum time in seconds for which a message is considered valid.

Configure this value sufficiently high, so that a frame generated by the root bridge can be propagated to the leaf nodes without exceeding the max-age.

The **forward delay**, **max-age**, and **hello time** parameters should be set according to the following formulae, as specified in IEEE Standard 802.1d:

$$2 \times (\text{forward delay} - 1.0 \text{ seconds}) \geq \text{max-age}$$

$$\text{max-age} \geq 2 \times (\text{hello time} + 1.0 \text{ seconds})$$

Example

```
awplus# configure terminal
awplus(config)# spanning-tree max-age 12
```

Related Commands `show spanning-tree`
`spanning-tree forward-time <forward-delay>`
`spanning-tree hello-time <hello-time>`

spanning-tree max-hops (MSTP)

Use this command to specify the maximum allowed hops for a BPDU in an MST region. This parameter is used by all the instances of the MST region.

Use the **no** variant of this command to restore the default value.

Use this command for MSTP only.

Syntax `spanning-tree max-hops <hop-count>`
`no spanning-tree max-hops`

Parameter	Description
<code><hop-count></code>	Maximum hops the BPDU will be valid for.

Default The default max-hops in a MST region is 20.

Mode Global Configuration

Usage Specifying the max hops for a BPDU prevents the messages from looping indefinitely in the network. The hop count is decremented by each receiving port. When a switch receives an MST BPDU that has a hop count of zero, it discards the BPDU.

Examples

```
awplus# configure terminal
awplus(config)# spanning-tree max-hops 25
```

spanning-tree mode

Use this command to change the spanning tree protocol mode on the device. This can be either STP, RSTP, or MSTP.

Syntax `spanning-tree mode {stp|rstp|mstp}`

Default The default mode is RSTP.

Mode Global Configuration

Usage With no configuration, the device will have spanning tree enabled, and the spanning tree mode will be set to RSTP. Use this command to change the spanning tree protocol mode on the device. MSTP is VLAN aware, but RSTP and STP are not VLAN aware. To enable or disable spanning tree operation, see the [spanning-tree enable command on page 19.28](#).

Examples To change the spanning tree mode from the default of RSTP to MSTP, use the following commands:

```
awplus# configure terminal
awplus(config)# spanning-tree mode mstp
```

Related commands [spanning-tree enable](#)

spanning-tree mst configuration

Use this command to enter the MST Configuration mode to configure the Multiple Spanning-Tree Protocol.

Syntax `spanning-tree mst configuration`

Mode Global Configuration

Examples The following example uses this command to enter MST configuration mode. Note the change in the command prompt.

```
awplus# configure terminal
awplus(config)# spanning-tree mst configuration
awplus(config-mst)#
```

spanning-tree mst instance

Use this command to assign a Multiple Spanning Tree instance (MSTI) to a switch port or channel group.

Note that ports are automatically configured to send and receive spanning-tree information for the associated MSTI when VLANs are assigned to MSTIs using the [instance vlan \(MSTP\)](#) command.

You can disable automatic configuration of member ports of a VLAN to an associated MSTI by using a **no spanning-tree mst instance** command to remove the member port from the MSTI. Use the **spanning-tree mst instance** command to add a VLAN member port back to the MSTI.

Use the **no** variant of this command to remove the MSTI from this port.

Syntax `spanning-tree mst instance <instance-id>`
`no spanning-tree mst instance`

Parameter	Description
<instance-id>	<1-15> Specify the instance ID. The instance must have already been created using the instance vlan (MSTP) command.

Default A port automatically becomes a member of MSTI(s) when it is assigned to VLAN(s).

Mode Interface Configuration

Examples

```
awplus# configure terminal
awplus(config)# interface port1.1.2
awplus(config-if)# spanning-tree mst instance 3
```

Related Commands [instance vlan \(MSTP\)](#)

spanning-tree mst instance path-cost

Use this command to set the cost of a path associated with a port, for the specified MSTI.

This specifies the port's contribution to the cost of a path to the MSTI regional root via that port. This applies when the port is the root port for the MSTI.

Use the **no** variant of this command to restore the default cost value of the path.

Syntax `spanning-tree mst instance <instance-id> path-cost <1-200000000>`
`no spanning-tree mst instance <instance-id> path-cost`

Parameter	Description
<code><instance-id></code>	Specify the instance identifier <1-15>
<code>path-cost</code>	<1-200000000> Specify the cost of path in the range of <1-200000000> (a lower path-cost indicates a greater likelihood of the specific interface becoming a root).

Default The default path cost values and the range of recommended path cost values depend on the port speed, as shown in the following table from the IEEE 802.1q-2003 standard.

Port speed	Default path cost	Recommended path cost range
Less than 100 Kb/s	200,000,000	20,000,000-200,000,000
1Mbps	20,000,000	2,000,000-20,000,000
10Mbps	2,000,000	200,000-2,000,000
100 Mbps	200,000	20,000-200,000
1 Gbps	20,000	2,000-20,000
10 Gbps	2,000	200-2,000
100 Gbps	200	20-200
1Tbps	20	2-200
10 Tbps	2	2-20

Mode Interface Configuration

Usage Before you can use this command to set a path-cost in a VLAN configuration, you must explicitly add an MST instance to a port using the `spanning-tree instance` command.

Example

```
awplus# configure terminal
awplus(config)# interface port1.1.2
awplus(config-if)# spanning-tree mst instance 3 path-cost 1000
```

Related Commands `instance vlan (MSTP)`
`spanning-tree mst instance`

spanning-tree mst instance priority

Use this command to set the port priority for an MST instance (MSTI).

This sets the value of the priority field contained in the port identifier. The MST algorithm uses the port priority when determining the root port for the switch in the MSTI. The port with the lowest value is considered to have the highest priority and will be chosen as root port over a port - equivalent in all other aspects - but with a higher priority value.

Use the **no** variant of this command to restore the default priority value.

Syntax `spanning-tree mst instance <instance-id> priority <priority>`
`no spanning-tree mst instance priority <instance-id>`

Parameter	Description
<code><instance-id></code>	Specify the identifier.
<code><priority></code>	This must be a multiple of 16 and within the range 0 to 240. A lower priority indicates greater likelihood of the port becoming the root port.

Default The default value is 128.

Mode Interface Configuration

Examples

```
awplus# configure terminal
awplus(config)# interface port1.2.3
awplus(config-if)# spanning-tree mst instance 3 priority 121
```

Related Commands [spanning-tree priority \(port priority\)](#)

spanning-tree path-cost

Use this command to set the cost of a path for the specified port. This value then combines with others along the path to the root bridge in order to determine the total cost path value from the particular port, to the root bridge. The lower the numeric value, the higher the priority of the path. This applies when the port is the root port.

Use this command for RSTP, STP or MSTP. When MSTP mode is configured, this will apply to the port's path cost for the CIST.

Syntax `spanning-tree path-cost <pathcost>`

`no spanning-tree path-cost`

Parameter	Description
<code><pathcost></code>	<code><1-200000000></code> The cost to be assigned to the port.

Default The default path cost values and the range of recommended path cost values depend on the port speed, as shown in the following table from the IEEE 802.1q-2003 and IEEE 802.1d-2004 standards.

Port speed	Default path cost	Recommended path cost range
Less than 100 Kb/s	200,000,000	20,000,000-200,000,000
1Mbps	20,000,000	2,000,000-20,000,000
10Mbps	2,000,000	200,000-2,000,000
100 Mbps	200,000	20,000-200,000
1 Gbps	20,000	2,000-20,000
10 Gbps	2,000	200-2,000
100 Gbps	200	20-200
1Tbps	20	2-200
10 Tbps	2	2-20

Mode Interface Configuration

Example

```
awplus# configure terminal
awplus(config)# interface port1.1.2
awplus(config-if)# spanning-tree path-cost 123
```

spanning-tree portfast (STP)

Use this command to set a port as an edge-port. The portfast feature enables a port to rapidly move to the forwarding state, without having first to pass through the intermediate spanning tree states. This command has the same effect as the [spanning-tree edgeport \(RSTP and MSTP\)](#) command, but the configuration displays differently in the output of some show commands.

- Note** You can run either of two additional parameters with this command. To simplify the syntax these are documented as separate commands. See the following additional portfast commands:
- [spanning-tree portfast bpdu-filter command on page 19.45](#)
 - [spanning-tree portfast bpdu-guard command on page 19.47.](#)

You can obtain the same effect by running the [spanning-tree edgeport \(RSTP and MSTP\)](#) command. However, the configuration output may display differently in some show commands.

Use the **no** variant of this command to set a port to its default state (not an edge-port).

Syntax `spanning-tree portfast`
`no spanning-tree portfast`

Default Not an edge port.

Mode Interface Mode

Usage Portfast makes a port move from a blocking state to a forwarding state, bypassing both listening and learning states. The portfast feature is meant to be used for ports connected to end-user devices not switches. Enabling portfast on ports that are connected to a workstation or server allows devices to connect to the network without waiting for spanning-tree to converge. For example, you may need hosts to receive a DHCP address quickly and waiting for STP to converge would cause the DHCP request to time out. Ensure you do not use portfast on any ports connected to another switch to avoid creating a spanning-tree loop on the network.

Use this command on a switch port that connects to a LAN with no other bridges attached. An edge port should never receive BPDUs. Therefore if an edge port receives a BPDU, the portfast feature takes one of three actions.

- Cease to act as an edge port and pass BPDUs as a member of a spanning tree network ([spanning-tree portfast \(STP\) command disabled](#)).
- Filter out the BPDUs and pass only the data and continue to act as a edge port ([spanning-tree portfast bpdu-filter command enabled](#))
- Block the port to all BPDUs and data ([spanning-tree portfast bpdu-guard command enabled](#)).

Example

```
awplus# configure terminal
awplus(config)# interface port1.1.2
awplus(config-if)# spanning-tree portfast
```

Related Commands spanning-tree edgeport (RSTP and MSTP)
show spanning-tree
spanning-tree portfast bpdu-filter
spanning-tree portfast bpdu-guard

spanning-tree portfast bpdu-filter

This command sets the portfast bpdu-filter feature and applies a filter to any BPDUs received. Enabling this feature ensures that portfast configured ports will not transmit any BPDUs and will ignore (filter out) any BPDUs received. BPDU Filter is not enabled on a port by default.

Using the **no** variant of this command to turn off the bpdu-filter, but retain the port's status as a portfast enabled port. If the port then receives a BPDU it will change its role from an **edge-port** to a **non edge-port**.

Syntax (Global Configuration)

```
spanning-tree portfast bpdu-filter
no spanning-tree portfast bpdu-filter
```

Syntax (Interface Configuration)

```
spanning-tree portfast bpdu-filter {default|disable|enable}
no spanning-tree portfast bpdu-filter
```

Parameter	Description
portfast	A port that behaves as an edge-port. Note that an edge port should never receive BPDUs. If a port does receive a BPDU then it will filter any received.
bpdu-filter	A portfast port that has bpdu-filter turned on will enter the STP blocking state if it receives a BPDU. This port type has one of the following parameters:
default	Takes the setting that has been configured for the whole switch, i.e. the setting made from the Global configuration mode.
disable	Turns off BPDU filter.
enable	Turns on BPDU filter.

Default BPDU Filter is not enabled on any ports by default.

Mode Global Configuration and Interface Configuration

Usage This command filters the BPDUs and passes only data to continue to act as an edge port. Using this command in Global Configuration mode applies the portfast bpdu-filter feature to all ports on the switch. Using it in Interface mode applies the portfast feature to a specific port, or range of ports. The command will operate in both RSTP and MSTP networks.

A port with portfast enabled will receive BPDUs by default, so you can use this command to stop BPDUs coming to or going from the port. This command will take a port out of portfast if it receives a BPDU and forces the port to be part of the STP topology. Unlike the [spanning-tree portfast bpdu-guard](#) command, which places the port into the disabled state, this command keeps the port up, but without portfast running on the port.

Use the [show spanning-tree](#) command to display status of the bpdu-filter parameter for the switch ports.

Example

```
awplus# configure terminal
awplus(config)# spanning-tree portfast bpdu-filter

awplus# configure terminal
awplus(config)# interface port1.1.2
awplus(config-if)# spanning-tree portfast bpdu-filter enable
```

Related Commands spanning-tree edgeport (RSTP and MSTP)
show spanning-tree
spanning-tree portfast (STP)
spanning-tree portfast bpdu-guard

spanning-tree portfast bpdu-guard

This command sets the portfast feature and applies a BPDU guard to the port. A port with the portfast bpdu-guard feature enabled will block all traffic (BPDUs and user data), if it starts receiving BPDUs.

Use this command in Global Configuration mode to set the portfast feature and apply BPDU guard to all ports on the switch. Use this command in Interface mode to for an individual interface or a range of interfaces specified. BPDU Guard is not enabled on a port by default.

Use the **no** variant of this command to disable the BPDU Guard feature on a switch in Global Configuration mode or to disable the BPDU Guard feature on a port in Interface mode.

Syntax (Global Configuration)

```
spanning-tree portfast bpdu-guard
no spanning-tree portfast bpdu-guard
```

Syntax (Interface Configuration)

```
spanning-tree portfast bpdu-guard {default|disable|enable}
no spanning-tree portfast bpdu-guard
```

Parameter	Description
portfast	A port that behaves as an edge-port. Note that an edge port should never receive BPDUs. If a port does receive a BPDU then it will cease to act as an edge port.
bpdu-guard	A portfast port that has bpdu-guard turned on will enter the STP blocking state if it receives a BPDU. This port type has one of the following parameters:
default	Takes the setting that has been configured for the whole switch, i.e. the setting made from the Global configuration mode.
disable	Turns off BPDU guard.
enable	Turns on BPDU guard and will also set the port as an edge port.

Default BPDU Guard is not enabled on any ports by default.

Mode Global Configuration or Interface Configuration

Usage This command blocks the port(s) to all BPDUs and data when enabled. BPDU Guard is a port-security feature that changes how a portfast-enabled port behaves if it receives a BPDU. When **bpdu-guard** is set, then the port shuts down if it receives a BPDU. It does not process the BPDU as it is considered suspicious. When **bpdu-guard** is not set, then the port will negotiate spanning-tree with the device sending the BPDUs. By default, bpdu-guard is not enabled on a port. If a port with portfast enabled receives a BPDU, the port will be moved to the disabled state. This stops the port being connected to another port that is configured with portfast, so guards against spanning-tree loops forming on the network.

You can configure a port disabled by the bpdu-guard to re-enable itself after a specific time interval. This interval is set with the [spanning-tree errdisable-timeout interval command on page 19.30](#). If you do not use the **errdisable-timeout** feature, then you will need to manually re-enable the port by using the **no shutdown** command.

Use the [show spanning-tree command on page 19.12](#) to display the switch and port configurations for the BPDU Guard feature. It shows both the administratively configured and currently running values of bpdu-guard.

Example

```
awplus# configure terminal
awplus(config)# spanning-tree portfast bpdu-guard

awplus# configure terminal
awplus(config)# interface port1.1.2
awplus(config-if)# spanning-tree portfast bpdu-guard enable
```

Related Commands [spanning-tree edgeport \(RSTP and MSTP\)](#)
[show spanning-tree](#)
[spanning-tree portfast \(STP\)](#)
[spanning-tree portfast bpdu-guard](#)

spanning-tree priority (bridge priority)

Use this command to set the bridge priority for the switch. A lower priority value indicates a greater likelihood of the switch becoming the root bridge.

Use this command for RSTP, STP or MSTP. When MSTP mode is configured, this will apply to the CIST.

Use the **no** variant of this command to reset it to the default value.

Syntax `spanning-tree priority <priority>`
`no spanning-tree priority`

Parameter	Description
<code><priority></code>	<code><0-61440></code> The bridge priority, which will be rounded to a multiple of 4096.

Default The default priority is 32678.

Mode Global Configuration

Usage To force a particular switch to become the root bridge use a lower value than other switches in the spanning tree.

Example

```
awplus# configure terminal
awplus(config)# spanning-tree priority 4096
```

Related Commands [spanning-tree mst instance priority](#)
[show spanning-tree](#)

spanning-tree priority (port priority)

Use this command to set the port priority for port. A lower priority value indicates a greater likelihood of the port becoming part of the active topology.

Use this command for RSTP, STP, or MSTP. When the device is in MSTP mode, this will apply to the CIST.

Use the **no** variant of this command to reset it to the default value.

Syntax `spanning-tree priority <priority>`
`no spanning-tree priority`

Parameter	Description
<code><priority></code>	<code><0-240></code> , in increments of 16. The port priority, which will be rounded down to a multiple of 16.

Default The default priority is 128.

Mode Interface Configuration

Usage To force a port to be part of the active topology (for instance, become the root port or a designated port) use a lower value than other ports on the device. (This behavior is subject to network topology, and more significant factors, such as bridge ID.)

Example

```
awplus# configure terminal
awplus(config)# interface port1.0.2
awplus(config-if)# spanning-tree priority 16
```

Related Commands `spanning-tree mst instance priority`
`spanning-tree priority (bridge priority)`
`show spanning-tree`

spanning-tree transmit-holdcount

Use this command to set the maximum number of BPDU transmissions that are held back.

Use the **no** variant of this command to restore the default transmit hold-count value.

Syntax `spanning-tree transmit-holdcount <1-10>`

`no spanning-tree transmit-holdcount <1-10>`

Parameter	Description
<code><1-10></code>	Transmit hold-count value

Default Transmit hold-count default value is 3.

Mode Global Configuration

Example

```
awplus# configure terminal
awplus(config)# spanning-tree transmit-holdcount 5
```

undebug mstp

This command applies the functionality of the [no debug mstp \(RSTP and STP\)](#) command on [page 19.3](#).

Chapter 20: Link Aggregation Configuration



Introduction.....	20.2
Link Aggregation Control Protocol (LACP)	20.2
Configuring A LACP Channel Group	20.3
Configuring A Static Channel Group.....	20.6

Introduction

This chapter contains a sample Link Aggregation Control Protocol (LACP), or dynamic channel group, configuration and a sample static channel group configuration.

To see details on the LACP and static channel group commands used in these examples, or to see the outputs of the validation commands, refer to [Chapter 21, Link Aggregation Commands](#). For a description of static and dynamic link aggregation (LACP), see “[Static and Dynamic \(LACP\) Link Aggregation](#)” on page 14.16.

Link Aggregation Control Protocol (LACP)

LACP is based on the IEEE Standard 802.3ad. It allows bundling of several physical ports to form a single logical channel providing enhanced performance and redundancy. The aggregated channel is viewed as a single link to each switch. The spanning tree views the channel as one interface and not as multiple interfaces. When there is a failure in one physical port, the other ports stay up and there is no disruption.

Note  AlliedWare Plus™ supports IEEE 802.3ad link aggregation and uses the Link Aggregation Control Protocol (LACP). LACP does not interoperate with devices that use Port Aggregation Protocol (PAgP).

This device supports the aggregation of a maximum of eight physical ports into a single channel group.

Note  LACP does not perform load balancing. The LACP algorithm is based on the packet flow. Link aggregation (LAG) hashes the source and destination MAC address, IP address and UDP/TCP ports to select a port on which to send a packet. So packet flow between a pair of hosts always takes the same port inside the LAG. The net effect is that the bandwidth for one packet stream is restricted to the speed of one link in the LAG. For example, for a 2 Gbps LAG that is a combination of two 1 Gbps ports, one flow of traffic can only ever reach a maximum throughput of 1 Gbps.

Note  For information about load balancing see the [platform load-balancing](#) command.

Configuring A LACP Channel Group

The following example shows how to configure three links between two Allied Telesis managed Layer 3 Switches. The three links are assigned the same administrative key (1), so that they aggregate to form a single channel (1). They are viewed by the STP as one interface.

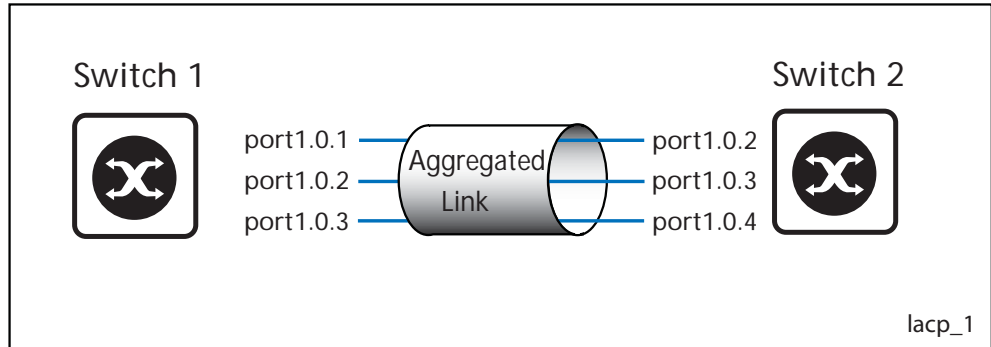

Table 20-1: Switch 1 configuration

<code>awplus#</code>	
<code>configure terminal</code>	Enter the Configure mode.
<code>awplus(config)#</code>	
<code>lACP system-priority 20000</code>	Set the system priority of this switch. This priority is used to determine which switch in the system is responsible for resolving conflicts in the choice of aggregation groups. A lower numerical value has a higher priority. Switch 1 has a higher priority than Switch 2 in this configuration.
<code>awplus(config)#</code>	
<code>interface port1.0.1</code>	Enter the Interface mode to configure port 1.0.1.
<code>awplus(config-if)#</code>	
<code>channel-group 1 mode active</code>	Add this interface to a channel group 1 and enable link aggregation so that it may be selected for aggregation by the local system.
<code>awplus(config-if)#</code>	
<code>exit</code>	Exit the Interface mode and return to the Configure mode.
<code>awplus(config)#</code>	
<code>interface port1.0.2</code>	Enter the Interface mode to configure port 1.0.2.
<code>awplus(config-if)#</code>	
<code>channel-group 1 mode active</code>	Add this interface to a channel group 1 and enable link aggregation so that it may be selected for aggregation by the local system.
<code>awplus(config-if)#</code>	
<code>exit</code>	Exit the Interface mode and return to the Configure mode.
<code>awplus(config)#</code>	
<code>interface port1.0.3</code>	Enter the Interface mode to configure port 1.0.3.
<code>awplus(config-if)#</code>	
<code>channel-group 1 mode active</code>	Add this interface to a channel group 1 and enable link aggregation so that it may be selected for aggregation by the local system.

Table 20-2: Switch 2 configuration

<code>awplus#</code>	
<code>configure terminal</code>	Enter the Configure mode.
<code>awplus(config)#</code>	
<code>lACP system-priority 3000</code>	Set the system priority of this switch. This priority is used to determine which switch in the system is responsible for resolving conflicts in the choice of aggregation groups. A lower numerical value has a higher priority. Switch 2 has a lower priority than Switch 1 in this configuration.
<code>awplus(config)#</code>	
<code>interface port1.0.2</code>	Enter the Interface mode to configure port 1.0.2.
<code>awplus(config-if)#</code>	
<code>channel-group 1 mode active</code>	Add this interface to a channel group 1 and enable link aggregation so that it may be selected for aggregation by the local system.
<code>awplus(config-if)#</code>	
<code>exit</code>	Exit the Interface mode and return to the Configure mode.
<code>awplus(config)#</code>	
<code>interface port1.0.3</code>	Enter the Interface mode to configure port 1.0.3.
<code>awplus(config-if)#</code>	
<code>channel-group 1 mode active</code>	Add this interface to a channel group 1 and enable link aggregation so that it may be selected for aggregation by the local system.
<code>awplus(config-if)#</code>	
<code>exit</code>	Exit the Interface mode and return to the Configure mode.
<code>awplus(config)#</code>	
<code>interface port1.0.4</code>	Enter the Interface mode to configure port 1.0.4.
<code>awplus(config-if)#</code>	
<code>channel-group 1 mode active</code>	Add this interface to a channel group 1 and enable link aggregation so that it may be selected for aggregation by the local system.

Commands Used `lACP system-priority`
`channel-group mode`

Validation Commands `show lACP sys-id`
`show port etherchannel`
`show etherchannel`
`show etherchannel detail`

Configuring A Static Channel Group

The following example creates a static channel group and adds switch ports 1.0.1 and 1.0.2.

```
awplus#  
configure terminal Enter the Configure mode.  
awplus(config)#  
interface port1.0.1 Enter the Interface mode to configure port 1.0.1.  
awplus(config-if)#  
static-channel-group 2 Add port 1.0.1 to static-channel-group 2.  
awplus(config-if)#  
exit Exit the Interface mode and return to the Configure mode.  
awplus(config)#  
interface port1.0.2 Enter Interface mode to configure port 1.0.2.  
awplus(config-if)#  
static-channel-group 2 Add port 1.0.2 to static-channel-group 2.
```

Commands Used static-channel-group

Validation Commands show static-channel-group

Chapter 21: Link Aggregation Commands





Command List	21.2
clear lacp counters	21.2
channel-group mode	21.3
debug lacp	21.5
lacp port-priority	21.6
lacp system-priority	21.6
lacp timeout	21.7
show debugging lacp	21.8
show etherchannel	21.9
show etherchannel detail	21.10
show etherchannel summary	21.11
show lacp-counter	21.12
show lacp sys-id	21.12
show port etherchannel	21.13
show static-channel-group	21.14
static-channel-group	21.15
undebug lacp	21.16

Command List

This chapter provides an alphabetical reference of commands used to configure a static channel group (static aggregator) and dynamic channel group (LACP channel group, etherchannel or LACP aggregator). Link aggregation is also sometimes referred to as channelling.

Note  AlliedWare Plus™ supports IEEE 802.3ad link aggregation and uses the Link Aggregation Control Protocol (LACP). LACP does not interoperate with devices that use Port Aggregation Protocol (PAgP).

Note  LACP does not perform load balancing. The LACP algorithm is based on the packet flow. Link aggregation (LAG) hashes the source and destination MAC address, IP address and UDP/TCP ports to select a port on which to send a packet. So packet flow between a pair of hosts always takes the same port inside the LAG. The net effect is that the bandwidth for one packet stream is restricted to the speed of one link in the LAG. For example, for a 2 Gbps LAG that is a combination of two 1 Gbps ports, one flow of traffic can only ever reach a maximum throughput of 1 Gbps.

Note  For information about load balancing see the [platform load-balancing](#) command.

For a description of static and dynamic link aggregation (LACP), see [“Static and Dynamic \(LACP\) Link Aggregation” on page 14.16](#). For an LACP configuration example, see [Chapter 20, Link Aggregation Configuration](#).

clear lacp counters

Use this command to clear all counters of all present LACP aggregators (channel groups) or a given LACP aggregator.

Syntax `clear lacp [<1-65535>] counters`

Parameter	Description
<1-65535>	Channel-group number.

Mode Privileged Exec

Example

```
awplus# clear lacp 2 counters
```

channel-group mode

Use this command to add the switch port to a dynamic channel group specified by the dynamic channel group number, and set its mode. You can create up to 32 channel groups. This command enables LACP link aggregation on the switch port, so that it may be selected for aggregation by the local system. Dynamic channel groups are also known as LACP channel groups, LACP aggregators or etherchannels.

Use the **no** variant of this command to turn off link aggregation on the switch port.

Syntax `channel-group <dynamic-channel-group-number> mode {active|passive}`
`no channel-group`

Parameter	Description
<code><dynamic-channel-group-number></code>	<code><1-99></code> Specify a dynamic channel group number for an LACP link. Note that up to 32 combined dynamic and static channel groups can be created on the switch. You can number the dynamic channel groups up to 99 for a total of 32 supported combined dynamic and static channel groups.
<code>active</code>	Enables initiation of LACP negotiation on a port. The port will transmit LACP dialogue messages whether or not it receives them from the partner system.
<code>passive</code>	Disables initiation of LACP negotiation on a port. The port will only transmit LACP dialogue messages if the partner systems is transmitting them, i.e. the partner is in the active mode.

Mode Interface Configuration

Usage All the switch ports in a channel-group must belong to the same VLANs, have the same tagging status, and can only be operated on as a group. All switch ports within a channel group must have the same port speed and be in full duplex mode.

Once the LACP channel group has been created, it is treated as a switch port, and can be referred to in most other commands that apply to switch ports.

To refer to an LACP channel group in other LACP commands, use the channel group number. To specify an LACP channel group (LACP aggregator) in other commands, prefix the channel group number with **po**. For example, `po4` refers to the LACP channel group with channel group number 4.

For more on LACP, see [“Dynamic \(LACP\) Channel Groups” on page 14.17](#) and [Chapter 20, Link Aggregation Configuration](#).

Examples To add switch port 1.2.10 to a newly created LACP channel group 4 use the commands below:

```
awplus# configure terminal
awplus(config)# interface port1.2.10
awplus(config-if)# channel-group 4 mode active
```

To remove switch port 1.1.8 from any created LACP channel groups use the command below:

```
awplus# configure terminal
awplus(config)# interface port1.1.8
awplus(config-if)# no channel-group
```

To reference the pre-defined LACP channel group 2 as an interface apply commands as below:

```
awplus# configure terminal
awplus(config)# interface port1.1.8
awplus(config-if)# channel-group 2 mode active
awplus(config-if)# exit
awplus(config)# interface port.1.1.10
awplus(config-if)# channel-group 2 mode active
awplus(config-if)# exit
awplus(config)# interface po2
awplus(config-if)#
```

Related Commands [show etherchannel](#)
[show etherchannel detail](#)
[show etherchannel summary](#)
[show port etherchannel](#)

debug lacp

Use this command to enable all LACP troubleshooting functions.

Use the **no** variant of this command to disable this function.

Syntax `debug lacp {all|cli|event|ha|packet|sync|timer[detail]}`
`no debug lacp {all|cli|event|ha|packet|sync|timer[detail]}`

Parameter	Description
<code>all</code>	Turn on all debugging for LACP.
<code>cli</code>	Specifies debugging for CLI messages. Echoes commands to the console.
<code>event</code>	Specifies debugging for LACP events. Echoes events to the console.
<code>ha</code>	Specifies debugging for HA (High Availability) events. Echoes High Availability events to the console.
<code>packet</code>	Specifies debugging for LACP packets. Echoes packet contents to the console.
<code>sync</code>	Specified debugging for LACP synchronization. Echoes synchronization to the console.
<code>timer</code>	Specifies debugging for LACP timer. Echoes timer expiry to the console.
<code>detail</code>	Optional parameter for LACP timer-detail. Echoes timer start/stop details to the console.

Mode Privileged Exec and Global Configuration

Examples

```
awplus# debug lacp timer detail
```

```
awplus# debug lacp all
```

Related Commands `show debugging lacp`
`undebug lacp`

lacp port-priority

Use this command to set the priority of a switch port. Ports are selected for aggregation based on their priority, with the higher priority (numerically lower) ports selected first.

Use the **no** variant of this command to reset the priority of port to the default value.

Syntax lacp port-priority <1-65535>
no lacp port-priority

Parameter	Description
<1-65535>	Specify the LACP port priority.

Default The default value is 32768.

Mode Interface Configuration

Example

```
awplus# configure terminal
awplus(config)# interface port1.2.5
awplus(config-if)# lacp port-priority 34
```

lacp system-priority

Use this command to set the system priority of a local system. This is used in determining the system responsible for resolving conflicts in the choice of aggregation groups.

Use the **no** variant of this command to reset the system priority of the local system to the default value.

Syntax lacp system-priority <1-65535>
no lacp system-priority

Parameter	Description
<1-65535>	LACP system priority. Lower numerical values have higher priorities.

Default The default value is 32768.

Mode Global Configuration

Example

```
awplus# configure terminal
awplus(config)# lacp system-priority 6700
```

lacp timeout

Use this command to set the short or long timeout on a port. Ports will time out of the aggregation if three consecutive updates are lost.

Syntax lacp timeout {short|long}

Parameter	Description
timeout	Number of seconds before invalidating a received LACP data unit (DU).
short	LACP short timeout. The short timeout value is 1 second.
long	LACP long timeout. The long timeout value is 30 seconds.

Default The default is **long** timeout (30 seconds).

Mode Interface Configuration

Usage This command enables the switch to indicate the rate at which it expects to receive LACPDUs from its neighbor.

If the timeout is set to **long**, then the switch expects to receive an update every **30** seconds, and this will time a port out of the aggregation if no updates are seen for 90 seconds (i.e. 3 consecutive updates are lost).

If the timeout is set to **short**, then the switch expects to receive an update every second, and this will time a port a port out of the aggregation if no updates are seen for 3 seconds (i.e. 3 consecutive updates are lost).

The switch indicates its preference by means of the 'Timeout' field in the 'Actor' section of its LACPDUs. If the 'Timeout' field is set to 1, then the switch has set the **short** timeout. If the 'Timeout' field is set to 0, then the switch has set the **long** timeout.

Setting the **short** timeout enables the switch to be more responsive to communication failure on a link, and does not add too much processing overhead to the switch (1 packet per second).

Note  It is not possible to configure the rate that the switch sends LACPDUs; the switch must send at the rate which the neighbor indicates it expects to receive LACPDUs.

Examples The following commands set the LACP long timeout period for 30 seconds on port 1.0.2.

```
awplus# configure terminal
awplus(config)# interface port1.0.2
awplus(config-if)# lacp timeout long
```

The following commands set the LACP short timeout for 1 second on port 1.0.2.

```
awplus# configure terminal
awplus(config)# interface port1.0.2
awplus(config-if)# lacp timeout short
```

show debugging lacp

Use this command to display the LACP debugging option set.

For information on output options, see [“Controlling “show” Command Output” on page 1.35.](#)

Syntax show debugging lacp

Mode User Exec and Privileged Exec

Example

```
awplus# show debugging lacp
```

Output Figure 21-1: Example output from the **show debugging lacp** command

```
LACP debugging status:
LACP timer debugging is on
LACP timer-detail debugging is on
LACP cli debugging is on
LACP packet debugging is on
LACP event debugging is on
LACP sync debugging is on
```

Related Commands debug lacp

show etherchannel

Use this command to display information about a LACP channel specified by the channel group number.

The command output also shows the thrash limiting status. If thrash limiting is detected and the **thrash limiting** parameter of the [thrash-limiting command on page 15.63](#) is set to **vlan disable**, the output will also show the VLANs on which thrashing is detected.

For information on output options, see ["Controlling "show" Command Output" on page 1.35](#).

Syntax show etherchannel [<1-65535>]

Mode User Exec and Privileged Exec

Example

```
awplus# show etherchannel 5
```

Output Figure 21-2: Example output from the **show etherchannel** command

```
% LACP Aggregator: po1
  Thrash-limiting
  Status Vlan Thrashing Detected, Action vlan-disable 60(s)
  Thrashing Vlans 1 2 3 4 5
% Member:
  port1.0.4
  port1.0.8
```

show etherchannel detail

Use this command to display detailed information about all LACP channels.

For information on output options, see [“Controlling “show” Command Output”](#) on [page 1.35](#).

Syntax show etherchannel detail

Mode Privileged Exec

Example

```
awplus# show etherchannel detail
```

Output Figure 21-3: Example output from the **show etherchannel detail** command

```
% Aggregator po1 (4501)
% Mac address: 00:00:cd:24:fd:29
% Admin Key: 0001 - Oper Key 0001
% Receive link count: 1 - Transmit link count: 0
% Individual: 0 - Ready: 1
% Partner LAG: 0x8000,00-00-cd-24-da-a7
% Link: port1.0.1 (5001) disabled
% Link: port1.0.2 (5002) sync: 1
% Aggregator po2 (4502)
% Mac address: 00:00:cd:24:fd:29
% Admin Key: 0002 - Oper Key 0002
% Receive link count: 1 - Transmit link count: 0
% Individual: 0 - Ready: 1
% Partner LAG: 0x8000,00-00-cd-24-da-a7
% Link: port1.0.7 (5007) disabled
```

show etherchannel summary

Use this command to display a summary of all LACP channels.

For information on output options, see [“Controlling “show” Command Output” on page 1.35.](#)

Syntax `show etherchannel summary`

Mode Privileged Exec

Example

```
awplus# show etherchannel summary
```

Output Figure 21-4: Example output from the `show etherchannel summary` command

```
% Aggregator po1
% Admin Key: 0001 - Oper Key 0001
% Link: port1.0.1 (5001) disabled
% Link: port1.0.2 (5002) sync: 1
% Aggregator po2
% Admin Key: 0002 - Oper Key 0002
% Link: port1.0.7 (5007) disabled
```

show lacp-counter

Use this command to display the packet traffic on all ports of all present LACP aggregators, or a given LACP aggregator.

For information on output options, see [“Controlling “show” Command Output” on page 1.35.](#)

Syntax `show lacp-counter [<1-65535>]`

Parameter	Description
<1-65535>	Channel-group number.

Mode User Exec and Privileged Exec

Example

```
awplus# show lacp-counter
```

Output Figure 21-5: Example output from the `show lacp-counter` command

% Traffic statistics						
Port	LACPDUs		Marker		Pckt err	
	Sent	Recv	Sent	Recv	Sent	Recv
% Aggregator po4 (4604)						
port1.0.2	0	0	0	0	0	0

show lacp sys-id

Use this command to display the LACP system ID and priority.

For information on output options, see [“Controlling “show” Command Output” on page 1.35.](#)

Syntax `show lacp sys-id`

Mode Privileged Exec

Example

```
awplus# show lacp sys-id
```

Output Figure 21-6: Example output from the `show lacp sys-id` command

% System Priority: 0x8000 (32768)
% MAC Address: 00-00-cd-24-fd-29

show port etherchannel

Use this command to show LACP details of the switch port specified.

For information on output options, see [“Controlling “show” Command Output” on page 1.35.](#)

Syntax `show port etherchannel <port>`

Parameter	Description
<port>	Name of the switch port to display LACP information about.

Mode Privileged Exec

Example

```
awplus# show port etherchannel port1.0.1
```

Output Figure 21-7: Example output from the `show port etherchannel` command

```
% Link: port1.0.1 (5001)
% Aggregator: po1 (4501)
% Receive machine state: Current
% Periodic Transmission machine state: Fast periodic
% Mux machine state: Collecting/Distributing
% Actor Information:
%   Selected ..... Selected
%   Physical Admin Key ..... 1
%   Port Key ..... 5
%   Port Priority ..... 32768
%   Port Number ..... 5001
%   Mode ..... Active
%   Timeout ..... Long
%   Individual ..... Yes
%   Synchronised ..... Yes
%   Collecting ..... Yes
%   Distributing ..... Yes
%   Defaulted ..... Yes
%   Expired ..... No
% Partner Information:
%   Partner Sys Priority ..... 0
%   Partner System .. 00-00-00-00-00-00
%   Port Key ..... 0
%   Port Priority ..... 0
%   Port Number ..... 0
%   Mode ..... Passive
%   Timeout ..... Short
%   Individual ..... Yes
%   Synchronised ..... Yes
%   Collecting ..... Yes
%   Distributing ..... Yes
%   Defaulted ..... Yes
%   Expired ..... No
```

show static-channel-group

Use this command to display all configured static channel groups and their corresponding member ports. Note that a static channel group is the same as a static aggregator.

The command output also shows the thrash limiting status. If thrash limiting is detected and the **thrash limiting** parameter of the [thrash-limiting command on page 15.63](#) is set to **vlan disable**, the output will also show the VLANs on which thrashing is detected.

For information on output options, see ["Controlling "show" Command Output" on page 1.35](#).

Syntax `show static-channel-group`

Mode User Exec and Privileged Exec

Example

```
awplus# show static-channel-group
```

Output [Figure 21-8: Example output from the show static-channel-group command](#)

```
% LAG Maximum      : 128
% LAG Static  Maximum: 96
% LAG Dynamic Maximum: 32
% LAG Static  Count  : 2
% LAG Dynamic Count  : 2
% LAG Total   Count  : 4
% Static Aggregator: sa2
% Member:
  port1.0.1
% Static Aggregator: sa3
% Member:
  port1.0.2
```

Related Commands [static-channel-group](#)

static-channel-group

Use this command to create a static channel group, also known as a static aggregator, or add a member port to an already existing static channel group.

Use the **no** variant of this command to remove the switch port from the static channel group.

Syntax `static-channel-group <static-channel-group-number>`

`no static-channel-group`

Parameter	Description
<code><static-channel-group-number></code>	<code><1-31></code> Static channel group number. A maximum of 32 combined static and dynamic channel groups is supported.

Mode Interface Configuration

Usage This command adds the switch port to the static channel group with the specified channel group number. If the channel group does not exist, it is created, and the port is added to it. The **no** prefix detaches the port from the static channel group. If the port is the last member to be removed, the static channel group is deleted.

All the ports in a channel group must have the same VLAN configuration: they must belong to the same VLANs and have the same tagging status, and can only be operated on as a group.

Once the static channel group has been created, it is treated as a switch port, and can be referred to in other commands that apply to switch ports.

To refer to a static channel group in other static channel group commands, use the channel group number. To specify a static channel group in other commands, prefix the channel group number with **sa**. For example, 'sa3' refers to the static channel group with channel group number 3.

For more on static channel groups, see [“Static Channel Groups” on page 14.16](#) and [Chapter 20, Link Aggregation Configuration](#).

Examples To define a static channel group on a switch port apply the example commands shown below:

```
awplus# configure terminal
awplus(config)# interface port1.1.6
awplus(config-if)# static-channel-group 3
```

To reference the pre-defined static channel group 2 as an interface apply the example commands as below:

```
awplus# configure terminal
awplus(config)# interface port1.1.8
awplus(config-if)# static-channel-group 2
awplus(config-if)# exit
awplus(config)# interface port.1.1.10
awplus(config-if)# static-channel-group 2
awplus(config-if)# exit
awplus(config)# interface sa2
awplus(config-if)#
```

Related Commands [show static-channel-group](#)

undebug lacp

This command applies the functionality of the [no debug lacp command on page 21.5](#).

Part 3: Layer Three, Switching and Routing



- Chapter 22 Internet Protocol (IP) Addressing and Protocols
- Chapter 23 IP Addressing and Protocol Commands
- Chapter 24 IPv6 Introduction
- Chapter 25 IPv6 Commands
- Chapter 26 IPv6to4 Tunneling Configuration
- Chapter 27 IPv6to4 Tunneling Commands
- Chapter 28 Routing Protocol Overview
- Chapter 29 Route Selection
- Chapter 30 Routing Commands
- Chapter 31 RIP Configuration
- Chapter 32 RIP Commands
- Chapter 33 RIPng Configuration
- Chapter 34 RIPng Commands
- Chapter 35 OSPF Configuration
- Chapter 36 OSPF Commands
- Chapter 37 BGP Configuration
- Chapter 38 BGP Commands
- Chapter 39 Route Map Configuration
- Chapter 40 Route Map Commands

Chapter 22: Internet Protocol (IP) Addressing and Protocols



Introduction.....	22.2
Address Resolution Protocol (ARP).....	22.3
Static ARP Entries.....	22.3
Timing Out ARP Entries.....	22.3
Deleting ARP Entries.....	22.4
Proxy ARP.....	22.4
ARP Logging.....	22.7
Domain Name System (DNS).....	22.8
Internet Control Message Protocol (ICMP).....	22.10
ICMP Router Discovery Protocol (IRDP).....	22.11
Checking IP Connections.....	22.15
Ping.....	22.15
Traceroute.....	22.15
IP Helper.....	22.16
IP Directed Broadcast.....	22.17

Introduction

This chapter describes how to configure IPv4 addressing and the protocols used to help IP function on your network.

As well as the familiar Internet, with uppercase "I", the term internet (with lowercase "i") can refer to any network (usually a wide area network) that uses the Internet protocol. This chapter concentrates on this definition—a generalized network that uses IP as its transport protocol.

Assigning an IP Address

To configure your device to perform IP routing (for example, to access the Internet) you need to configure IP. You also need to configure IP if you want to manage your device from any IP-based management process (such as SSH, Telnet, or SNMP).

Add an IP address to each of the interfaces that you want to process IP traffic.

You can configure an interface on your device with a static IP address, or with a dynamic IP address assigned using your device's DHCP client.

Static IP addresses

To add a static IP address to an interface, enter interface mode for the interface that you want to configure, then use the command:

```
awplus(config-if)# ip address <ip-addr/prefix-length> [secondary [label <label>]]
```

where `<ip-address/m>` the IP address followed by a slash then the prefix length. Note that you cannot specify the mask in dotted decimal notation in this command.

For example, to give the interface `vlan1` an address of `192.168.10.10`, with a class C subnet mask, use the command:

```
awplus(config-if)# ip address 192.168.10.10/24
```

The **secondary** parameter allows you to add multiple IP addresses to an interface using this command. Each interface must have a primary IP address before you can add a secondary address. Your device treats secondary addresses the same as primary addresses in most instances, such as responding for ARP requests for the IP address. However, the only packets generated that have a secondary address as source address are routing updates. You can define up to 32 secondary addresses on a single interface.

DHCP dynamic addresses

When you use the DHCP client, it obtains the IP address and subnet mask for the interface, and other IP configuration parameters, from a DHCP server. To configure an interface to gain its IP configuration using the DHCP client, use the command:

```
awplus(config-if)# ip address dhcp [client-id <interface>] [hostname <hostname>]
```

If an IP interface is configured to get its IP address and subnet mask from DHCP, the interface does not take part in IP routing until the IP address and subnet mask have been set by DHCP.

If you need to make a static entry in your DHCP server for the device, you need your device's MAC address, which you can display by using the command:

```
awplus# show interface
```

See [Chapter 75, Dynamic Host Configuration Protocol \(DHCP\) Introduction](#) for more information about DHCP.

Address Resolution Protocol (ARP)

Address Resolution Protocol (ARP) is used by your device to dynamically learn the layer 2 address of devices in its networks. Most hosts also have a MAC physical address in addition to the assigned IP address. For Ethernet, this is a 6-byte, globally unique number. ARP enables your device to learn the physical address of the host that has a given IP address.

When your device needs to forward packets to a destination that it does not know the layer 2 address of, it broadcasts an ARP request to determine where to send the packet. The ARP request is a broadcast packet and includes the target IP address. All stations on the LAN receive this broadcast but only one host recognizes its own IP address. It replies, thereby giving your device its physical address.

Your device creates a dynamic ARP entry in its ARP cache, to record the IP address to physical address mapping (also called a binding). It uses that ARP entry to forward further packets to that address.

The ARP protocol is described in RFC 826, *An Ethernet Address Resolution Protocol—or—Converting Network Protocol Addresses to 48 bit Ethernet Address for Transmission on Ethernet Hardware*.

Static ARP Entries

If your LAN includes hosts that do not support ARP, you can add a static ARP entry to the cache. However, it is rarely necessary to add an ARP entry this way. To add a static ARP entry, use the command:

```
awplus(config)# arp <ip-addr> <mac-address> [<port-number>] [alias]
```

Timing Out ARP Entries

Your device times out dynamic ARP entries to ensure that the cache does not fill with entries for hosts that are no longer active. If your device stops receiving traffic for a device specified in a dynamic ARP entry, it deletes the ARP entry after a configurable timeout period. Static ARP entries are not aged or automatically deleted.

Increasing the ARP timeout reduces the amount of network traffic. Decreasing the timeout makes your device more responsive to changes in network topology.

To set a timeout period, enter the interface mode, then use the command:

```
awplus(config-if)# arp-aging-timeout <1-432000>
```

Deleting ARP Entries

To remove a static ARP entry, use the command:

```
awplus(config)# no arp <ip-addr>
```

To clear the ARP cache of dynamic entries, use the command:

```
awplus# clear arp-cache
```

This removes the dynamic ARP entries for all interfaces.

To display the entries in the ARP cache, use the command:

```
awplus)# show arp
```

The ARP cache will be repopulated by the normal ARP learning mechanism. As long as the entries are relearned quickly enough, deleting dynamic ARP entries does not affect:

- routes
- OSPF neighbor status
- BGP peer status
- the TCP/UDP connection status
- VRRP status

Proxy ARP

Proxy ARP (defined in RFC 1027) allows hosts that do not support routing (i.e. they have no knowledge of the network structure) to determine the physical addresses of hosts on other networks. Your device intercepts ARP broadcast packets and substitutes its own physical address for that of the remote host. This occurs only if your device has the best route to the remote host. By responding to the ARP request, your device ensures that subsequent packets from the local host are directed to its physical address, and it can then forward these to the remote host. The process is symmetrical.

Proxy ARP is disabled by default. To enable proxy ARP on an interface, use the commands:

```
awplus(config)# interface <interface>
```

```
awplus(config-if)# ip proxy-arp
```

To disable Proxy ARP on an interface, use the command:

```
awplus(config-if)# no ip proxy-arp
```

To check Proxy ARP is enabled on an interface, use the **show running-config** command. If Proxy ARP has been enabled an entry shows **ip proxy-arp** below the interface it is enabled on. No **ip proxy-arp** entry below an interface in the config indicates Proxy ARP is disabled on it.

See the sample configuration commands and validation command with resulting output showing proxy ARP **enabled** on VLAN 2 below:

```
awplus#configure terminal
awplus(config)#interface vlan2
awplus(config-if)#ip proxy-arp
awplus(config-if)#end
awplus(config)#exit
awplus#show running-config
!
interface vlan2
  ip proxy-arp
  ip address 192.168.2.2/24
!
```

See the sample configuration commands and validation command with resulting output showing proxy ARP **disabled** on VLAN 2 below:

```
awplus#configure terminal
awplus(config)#interface vlan2
awplus(config-if)#no ip proxy-arp
awplus(config-if)#end
awplus(config)#exit
awplus#show running-config
!
interface vlan2
  ip address 192.168.2.2/24
!
```

Local Proxy ARP

Local Proxy ARP lets you stop MAC address resolution between hosts within an interface's subnet. This ensures that devices within a subnet cannot send traffic that bypasses layer 3 routing on your device. This lets you monitor, filter, and control traffic between devices in the same subnet.

Local Proxy ARP extends proxy ARP by intercepting and responding to ARP requests between hosts within a subnet. Local proxy ARP responds to ARP requests with your device's own MAC address details instead of those from the destination host. This stops hosts from learning the MAC address of other hosts within its subnet.

When Local Proxy ARP is operating on an interface, your device does not generate or forward any ICMP-Redirect messages on that interface.

Local Proxy ARP is disabled by default. To enable local proxy ARP on an interface, use the commands:

```
awplus(config)# interface <interface>
awplus(config-if)# ip local-proxy-arp
```

To disable local proxy ARP on an interface, use the command:

```
awplus(config-if)# no ip local-proxy-arp
```

To check Local Proxy ARP is enabled on an interface, use the **show running-config** command. If Local Proxy ARP has been enabled an entry shows **ip local-proxy-arp** below the interface it is enabled on. No **ip local-proxy-arp** entry below an interface in the config indicates Local Proxy ARP is disabled on it.

See the sample configuration commands and validation command with resulting output showing local proxy ARP **enabled** on VLAN 1 below:

```
awplus#configure terminal
awplus(config)#interface vlan1
awplus(config-if)#ip local-proxy-arp
awplus(config-if)#end
awplus(config)#exit
awplus#show running-config
!
interface vlan1
 ip local-proxy-arp
 ip address 192.168.1.2/24
!
```

See the sample configuration commands and validation command with resulting output showing Local Proxy ARP **disabled** on VLAN 1 below:

```
awplus#configure terminal
awplus(config)#interface vlan1
awplus(config-if)#no ip local-proxy-arp
awplus(config-if)#end
awplus(config)#exit
awplus#show running-config
!
interface vlan1
 ip address 192.168.1.2/24
!
```

ARP Logging

You can enable your device to log static and dynamic ARP entries, and you can select either default hexadecimal notation (HHHH.HHHH.HHHH) or standard IEEE format hexadecimal notation (HH-HH-HH-HH-HH-HH) for the MAC addresses displayed in the ARP log output.

If this feature is enabled, ARP log messages are stored on the device in RAM. If the device is rebooted the ARP log messages are lost. ARP logging is disabled by default.

To enable ARP logging, use the command:

```
awplus(config)# arp log [mac-address-format ieee]
```

You can specify whether the MAC address is displayed in the default hexadecimal notation HHHH.HHHH.HHHH or in the standard IEEE format HH-HH-HH-HH-HH-HH.

To disable ARP logging, use the command:

```
awplus(config)# no arp log [mac-address-format ieee]
```

To display the ARP log messages, use the command:

```
awplus(config)# show log | include ARP_LOG
```

See the sample ARP log output and descriptions of the fields displayed in the sample ARP log output in the [arp log command on page 23.4](#).

Domain Name System (DNS)

The Domain Name System allows you to access remote systems by entering human-readable device host names rather than IP addresses. DNS works by creating a mapping between a device name, such as "www.alliedtelesis.com", and its IP address. These mappings are held on DNS servers. The benefits of DNS are that domain names:

- can map to a new IP address if the host's IP address changes
- are easier to remember than an IP address
- allow organizations to use a domain name hierarchy that is independent of any IP address assignment

Domain name parts

Domain names are made up of a hierarchy of two or more name segments. Each segment is separated by a period. The format of domain names is the same as the host portion of a URL (Uniform Resource Locator). The first segment from the left is unique to the host, with each following segment mapping the host in the domain name hierarchy. The segment on the far right is a top-level domain name shared by many hosts.

Server hierarchy

A network of domain name servers maintains the mappings between domain names and their IP addresses. This network operates in a hierarchy that is similar to the structure of the domain names. When a local DNS server cannot resolve your request it sends the request to a higher level DNS server.

For example, to access the site "alliedtelesis.com", your PC sends a DNS enquiry to its local DNS server asking for the IP address matching alliedtelesis.com. If this address is already locally cached (following its recent use), the DNS server returns the IP address that matches alliedtelesis.com. If the DNS server does not have this address cached, it forwards the request upwards through the hierarchy of DNS servers until a DNS server can resolve the mapping. This means an often-used domain name is resolved quickly, while an uncommon or nonexistent domain may take longer to resolve or fail.

As well as the hierarchy of domain name servers accessible through the Internet, you can operate your own DNS server to map to private IP addresses within your network.

DNS client

Your AlliedWare Plus™ device has a DNS client that is enabled automatically when you add a DNS server to your device. This client allows you to use domain names instead of IP addresses when using commands on your device.

To add a DNS server to the list of servers that the device sends DNS queries to, use the command:

```
awplus(config)# ip name-server <ip-addr>
```

To check the list of servers that the device sends DNS queries to, use the command:

```
awplus# show ip name-server
```

To add a default domain name used to append to DNS requests, use the command:

```
awplus(config)# ip domain-name <domain-name>
```

For example, to use DNS to match hostnames to your internal network "example.net", use the command:

```
awplus(config)# ip domain-name example.net
```

If you then use the command `ping host2`, your device sends a DNS request for `host2.example.net`. To check the domain name configured with this command, use the command:

```
awplus# show ip domain-name
```

Alternatively you can create a list of domain names that your device will try in turn by using the command:

```
awplus(config)# ip domain-list <domain-name>
```

For example, to use DNS to match incomplete hostnames to the top level domains “.com”, and “.net”, use the commands:

```
awplus(config)# ip domain-list .com
```

```
awplus(config)# ip domain-list .net
```

If you then use the command `ping alliedtelesis`, your device sends a DNS request for `alliedtelesis.com` and if no match was found your device would then try `alliedtelesis.net`. To check the entries in the domain list, use the command:

```
awplus# show ip domain-list
```

To disable the DNS client on your device, use the command:

```
awplus(config)# no ip domain-lookup
```

To check the status of the DNS client on your device, and the configured servers and domain names, use the command:

```
awplus# show hosts
```

DHCP options

When your device is using its DHCP client for an interface, it can receive the following DHCP options from the DHCP server:

- Option 6 - a list of DNS servers. This list appends to the DNS servers set on your device with the `ip name-server` command.
- Option 15 - a domain name used to resolve host names. This option replaces the domain name set with the `ip domain-name` command.

See [Chapter 75, Dynamic Host Configuration Protocol \(DHCP\) Introduction](#) for more information about DHCP and DHCP options.

Internet Control Message Protocol (ICMP)

The Internet Control Message Protocol (ICMP) allows networking devices to send information and control messages to other devices or hosts. Your device implements all non-obsolete ICMP functions.

The following table lists the ICMP messages implemented by your device.

ICMP Message Type	Device Response
Echo reply (0)	This is used to implement the ping command. Your device sends out an echo reply in response to an echo request.
Destination unreachable (3)	This message is sent when your device drops a packet because it did not have a route to the destination.
Redirect (5)	<p>Your device issues this message to inform a local host that its target is located on the same LAN (no routing is required) or when it detects a host using a non-optimal route (usually because a link has failed or changed its status).</p> <p>For example, if your device receives a packet destined to its own MAC address, but with a destination IP address of another host in the local subnet, it returns an ICMP redirect to the originating host.</p> <p>ICMP redirects are disabled on interfaces on which local proxy ARP is enabled.</p>
Echo request (8)	This is related to echo replies. If your device receives an echo request, it sends an echo reply. If you enter the ping command, your device generates echo requests.
Router Advertisements (10)	These are Router Discovery Protocol messages. If Router Discovery is enabled, your device sends these to announce the IP addresses of the sending interface.
Time to Live Exceeded (11)	If the TTL field in a packet falls to zero, your device sends this message. This occurs when there are too many hops in the path that a packet is traversing.

ICMP messages are enabled on all interfaces by default. You can control the flow of ICMP messages across different interfaces using the `access-list` commands. See [Chapter 50, IPv4 Access Control List \(ACL\) Commands](#).

ICMP Router Discovery Protocol (IRDP)

Router discovery Your device supports the router specification sections of RFC 1256, *ICMP Router Discovery Messages*. If this feature is configured, your device sends router advertisements periodically and in response to router solicitations. It does not support the Host Specification section of this RFC.

Benefits Before an IP host can send an IP packet, the host has to know the IP address of a neighboring router that can forward the packet to its destination. ICMP Router Discovery messages let routers automatically advertise themselves to hosts. Other methods either require someone to manually keep these addresses current, or require DHCP to send router addresses.

Router discovery process The following table summarizes what happens when Router Discovery advertisements are enabled on an interface.

When...	Then...
Router Discovery advertising starts on an interface because: <ul style="list-style-type: none"> - your device starts up, or - you enable advertisements on your device or on an interface 	your device multicasts a router advertisement and continues to multicast them periodically until router advertising is disabled.
a host starts up	the host may send a router solicitation message.
your device receives a router solicitation	your device multicasts an early router advertisement from the interface on which it received the router solicitation.
a host receives a router advertisement	the host stores the IP address and preference level for the advertisement lifetime.
the lifetimes of all existing router advertisements on a host expire	the host sends a router solicitation.
a host does not receive a router advertisement after sending a small number of router solicitations	the host waits for the next unsolicited router advertisement.
a host needs a default router address	the host uses the IP address of the router or L3 switch with the highest preference level.
Router Discovery advertising is deleted from the interface	your device multicasts a router advertisement with the IP address(es) that stopped advertising, and a lifetime of zero. It continues to periodically multicast router advertisements for other interfaces, if configured to.
the router receives a router advertisement from another router	the router does nothing but silently discards the message

- Advertisement messages** A router advertisement is an ICMP (type 10) message that contains the following:
- in the destination address field of the IP header, the interface's configured advertisement address, either 224.0.0.1 or 255.255.255.255.
 - in the lifetime field, the interface's configured advertisement lifetime.
 - in the Router Address and Preference Level fields, the addresses and preference levels of all the logical interfaces that are set to advertise.

Your device does not send router advertisements by default.

- Solicitation message** A router solicitation is an ICMP (type 10) message containing:
- source Address: an IP address belonging to the interface from which the message is sent
 - destination Address: the configured Solicitation Address, and
 - Time-to-Live: 1 if the Destination Address is an IP multicast address; at least 1 otherwise.

- Advertisement interval** The router advertisement interval is the time between router advertisements. For the first few advertisements sent from an interface (up to 3), your device sends the router advertisements at intervals of at most 16 seconds. After these initial transmissions, it sends router advertisements at random intervals between the minimum and maximum intervals that the user configures, to reduce the probability of synchronization with the advertisements from other routers on the same link. By default, the minimum is 450 seconds (7.5 minutes), and the maximum is 600 seconds (10 minutes).

- Preference level** The preference level is the preference of the advertised address as a default router address relative to other router addresses on the same subnet. By default, all routers and layer 3 switches have the same preference level, zero. While it is entered as a decimal from 0 to 2147483647, it is encoded in router advertisements as a two's-complement hex integer from 0x8000000 to 0x7fffffff. A higher preference level is preferred over a lower value.

- Lifetime** The lifetime of a router advertisement is how long the information in the advertisement is valid. By default, the lifetime of all advertisements is 1800 seconds (30 minutes).

- Address type** Your device can send its router advertisements using either a broadcast or multicast destination address. By default, your device sends router advertisements using the all-systems multicast address (224.0.0.1). However, on networks where the hosts do not support IP multicast you must use the broadcast address (255.255.255.255). To change the address type to broadcast on an interface, use the command:

```
awplus(config-if)# ip irdp broadcast
```

To change the address type back to multicast, use the **no** variant of the above command, or use the command:

```
awplus(config-if)# ip irdp multicast
```

Configuration procedure

Do the following to configure your device to send router advertisements.

Step 1: Enter the interface to advertise.

Enter the configuration mode for the interface, using the command:

```
awplus(config)# interface <interface>
```

Step 2: Change the address type.

By default, your device sends router advertisements using a multicast destination address. If hosts on your network do not support this, change the address type to broadcast, using the command:

```
awplus(config-if)# ip irdp broadcast
```

Step 3: Configure the advertisement interval and lifetime.

By default, your device sends router advertisements every 7.5 to 10 minutes, with a lifetime of 30 minutes. These settings are likely to work well in most situations, and will not cause a large amount of extra traffic, even if there are several routers on the LAN. If you change these settings, keep the following proportions:

```
lifetime=3 x maxadvertisementinterval  
minadvertisementinterval=0.75 x maxadvertisementinterval
```

You cannot set the maximum advertisement interval below the minimum interval. If you are lowering the maximum interval to a value below the current minimum interval, you must change the minimum value first. This also applies to changing the minimum interval above the current maximum interval.

To change the maximum advertisement interval, use the command:

```
awplus(config-if)# ip irdp maxadvertinterval <4-1800>
```

To change the minimum advertisement interval, use the command:

```
awplus(config-if)# ip irdp minadvertinterval <3-1800>
```

To change the lifetime for your device's router advertisements, use the command:

```
awplus(config-if)# ip irdp lifetime <0-9000>
```

Step 4: Set preference levels.

By default, every interface has the same preference for becoming a default router. To give the interface a higher preference, increase the preference level. To give it a lower preference, decrease this value.

To set the preference level for all addresses on this interface, use the command:

```
awplus(config-if)# ip irdp preference <0-2147483647>
```

To set the preference for a specific address on the interface, use the command:

```
awplus(config-if)# ip irdp address <ip-address> preference <0-2147483647>
```

Step 5: Enable advertising on the interface.

To enable router advertisements on an interface, enter the interface mode and use the command:

```
awplus(config-if)# ip irdp
```

Step 6: Enable advertising on your device.

To globally enable router advertisements on your device, enter the configure mode and use the command:

```
awplus(config)# router ip irdp
```

Step 7: Check advertise settings.

To view the IRDP configuration on the interface, use the command:

```
awplus# show ip irdp interface [<interface-name>]
```

To view the global IRDP configuration for your device, use the command:

```
awplus# show ip irdp
```

Debugging IRDP

Information which may be useful for troubleshooting IRDP is available using the IRDP debugging function. To enable IRDP debugging, use the command:

```
awplus# debug ip irdp {event|nsm|receive|send|both|detail|all}
```

Checking IP Connections

To verify connections between networks and network devices, use the ping (Packet Internet Groper) and trace route functions on your device.

Ping

Ping tests the connectivity between two network devices to determine whether each network device can “see” the other device. Echo request packets are sent to the destination addresses and responses are displayed on the console.

If you can ping the end destination, then the physical, Layer 2 and Layer 3 links are functioning, and any difficulties are in the network or higher layers.

If pinging the end destination fails, use traceroute to discover the point of failure in the route to the destination.

To ping a device, use the command: .

```
awplus# ping {<hostname> | <ipaddr>}
```

Traceroute

You can use traceroute to discover the route that packets pass between two systems running the IP protocol. Traceroute sends an initial UDP packets with the Time To Live (TTL) field in the IP header set starting at 1. The TTL field is increased by one for every subsequent packet sent until the destination is reached. Each hop along the path between two systems responds with a TTL exceeded packet (ICMP type 11) and from this the path is determined.

To use traceroute, use the command:

```
awplus# traceroute {<ip-addr>|<hostname>}
```

where WORD can be either the hostname or the IP address of the device you are trying to reach.

IP Helper

The IP Helper feature allows the switch to receive UDP broadcasts on one subnet, and forward them as broadcasts or unicasts into another subnet, so a client can use an application which uses UDP broadcast (such as Net-BIOS) when the client and server are located in different subnets. The IP Helper feature forwards UDP broadcast network traffic to specific hosts on another subnet and/or to the broadcast address of another subnet.

When the IP Helper feature is enabled on a VLAN interface, the UDP broadcast packets received on the interface are processed for forwarding out through another interface into another subnet. Depending on the nature of the ip-helper addresses configured, the UDP broadcasts will be unicast forwarded to a single host in the destination subnet, or unicast forwarded to multiple hosts in the destination subnet, or broadcast to the broadcast address of the destination subnet. Not all UDP broadcasts will be forwarded when IP Helper is configured. The set of broadcasts to be forwarded can be defined by specifying the destination UDP port(s) of the packets you wish to forward.

The command to enable the forwarding of UDP broadcasts received on a given interface is `ip helper-address` (entered in interface configuration mode). The `ip forward-protocol udp` command specifies types of broadcast packets to forward.

Multiple different destination addresses can be specified by using multiple instances of the `ip helper-address` command under the same interface. If a destination address is specified that is actually the broadcast address of one of the subnets directly connected to the switch, then the UDP packets will be forwarded as broadcasts onto that subnet.

Likewise, multiple different types of UDP packet can be specified for forwarding by specifying multiple different destination ports using the `ip forward-protocol udp` command.

Note  The types of UDP broadcast packets that the switch will forward are **only** those specified by the `ip forward-protocol` command(s). There are not other UDP packet types that the IP helper process forwards by default.

IP Directed Broadcast

IP directed-broadcast is enabled and disabled per VLAN interface. When enabled a directed broadcast packet is forwarded to an enabled VLAN interface if received on another subnet.

An IP directed broadcast is an IP packet whose destination address is a broadcast address for some IP subnet, but originates from a node that is not itself part of that destination subnet. When a directed broadcast packet reaches a switch that is directly connected to its destination subnet, the packet is flooded as a broadcast on the destination subnet.

The `ip directed-broadcast` command controls the flooding of directed broadcasts when they reach target subnets. The command affects the final transmission of the directed broadcast on its destination subnet. It does not affect the transit unicast routing of IP directed broadcasts. If directed broadcast is enabled for an interface, incoming directed broadcast IP packets intended for the subnet assigned to interface will be flooded as broadcasts on that subnet.

If the `no ip directed-broadcast` command is configured for an interface, directed broadcasts destined for the subnet where the interface is attached will be dropped instead of broadcast.

Chapter 23: IP Addressing and Protocol Commands



Command List	23.2
arp-aging-timeout.....	23.2
arp (IP address MAC address).....	23.3
arp log.....	23.4
clear arp-cache	23.7
debug ip packet interface.....	23.8
debug ip irdp	23.10
ip address.....	23.11
ip domain-list	23.12
ip domain-lookup.....	23.13
ip domain-name.....	23.14
ip directed-broadcast.....	23.15
ip forwarding.....	23.16
ip forward-protocol udp.....	23.17
ip gratuitous-arp-link.....	23.19
ip helper-address.....	23.20
ip irdp.....	23.21
ip irdp address preference.....	23.22
ip irdp broadcast.....	23.23
ip irdp holdtime	23.24
ip irdp lifetime.....	23.25
ip irdp maxadvertinterval.....	23.26
ip irdp minadvertinterval.....	23.27
ip irdp multicast.....	23.28
ip irdp preference.....	23.29
ip local-proxy-arp.....	23.30
ip name-server.....	23.31
ip proxy-arp.....	23.32
ip redirects.....	23.33
optimistic-nd	23.34
ping.....	23.35
router ip irdp.....	23.36
show arp	23.37
show debugging ip packet.....	23.38
show hosts.....	23.39
show ip domain-list.....	23.40
show ip domain-name	23.40
show ip forwarding.....	23.41
show ip interface brief.....	23.42
show ip irdp	23.43
show ip irdp interface.....	23.44
show ip name-server	23.46
tcpdump.....	23.47
tracert.....	23.47
undebug ip packet interface.....	23.48
undebug ip irdp.....	23.48

Command List

This chapter provides an alphabetical reference of commands used to configure the following protocols:

- Address Resolution Protocol (ARP)
- Domain Name Service (DNS)
- ICMP Router Discovery Advertisements (IRDP)

For more information see [Chapter 22, Internet Protocol \(IP\) Addressing and Protocols](#).

arp-aging-timeout

This command sets a timeout period on dynamic ARP entries associated with a specific interface. If your device stops receiving traffic for the host specified in a dynamic ARP entry, it deletes the ARP entry from the ARP cache after this timeout is reached.

Your device times out dynamic ARP entries to ensure that the cache does not fill with entries for hosts that are no longer active. Static ARP entries are not aged or automatically deleted.

By default the time limit for dynamic ARP entries is 300 seconds on all interfaces.

The **no** variant of this command sets the time limit to the default of 300 seconds.

Syntax `arp-aging-timeout <1-432000>`
`no arp-aging timeout`

Parameter	Description
<code><1-432000></code>	The timeout period in seconds.

Default 300 seconds (5 minutes)

Mode Interface Configuration for a VLAN interface.

Example To set the ARP entries on interface `vlan30` to time out after two minutes, use the commands:

```
awplus(config)# interface vlan30
awplus(config-if)# arp-aging-timeout 120
```

Related Commands `clear arp-cache`
`show arp`

arp (IP address MAC address)

This command adds a static ARP entry to the ARP cache. This is typically used to add entries for hosts that do not support ARP or to speed up the address resolution function for a host. The ARP entry must not already exist. Use the **alias** parameter to allow your device to respond to ARP requests for this IP address.

The **no** variant of this command removes the static ARP entry. Use the [clear arp-cache](#) command to remove the dynamic ARP entries in the ARP cache.

Syntax `arp <ip-addr> <mac-address> [<port-number>] [alias]`
`no arp <ip-addr>`

Parameter	Description
<code><ip-addr></code>	IPv4 address of the device you are adding as a static ARP entry.
<code><mac-address></code>	MAC address of the device you are adding as a static ARP entry, in hexadecimal notation with the format HHHH.HHHH.HHHH.
<code><port-number></code>	The port number associated with the IP address. Specify this when the IP address is part of a VLAN.
<code>alias</code>	Allows your device to respond to ARP requests for the IP address. Proxy ARP must be enabled on the interface before using this parameter.

Mode Global Configuration

Example To add the IP address 10.10.10.9 with the MAC address 0010.2533.4655 into the ARP cache, and have your device respond to ARP requests for this address, use the commands:

```
awplus# configure terminal
awplus(config)# arp 10.10.10.9 0010.2355.4566 alias
```

Related Commands [clear arp-cache](#)
[ip proxy-arp](#)
[show arp](#)

arp log

This command enables the logging of dynamic and static ARP entries in the ARP cache. The ARP cache contains mappings of switch ports, VLAN IDs, and IP addresses to physical MAC addresses for hosts.

This command can display the MAC addresses in the ARP log either using the default hexadecimal notation (HHHH.HHHH.HHHH), or using the IEEE standard hexadecimal notation (HH-HH-HH-HH-HH-HH).

Use the **no** variant of this command to disable the logging of dynamic and static ARP entries in the ARP cache.

Syntax `arp log [mac-address-format ieee]`
`no arp log [mac-address-format ieee]`

Parameter	Description
<code>mac-address-format ieee</code>	Display the MAC address in hexadecimal notation with the standard IEEE format (HH-HH-HH-HH-HH-HH), instead of displaying the MAC address with the default hexadecimal format (HHHH.HHHH.HHHH)

Default The ARP logging feature is disabled by default.

Mode Global Configuration

Usage You have the option to change how the MAC address is displayed in the ARP log message, to use the default hexadecimal notation (HHHH.HHHH.HHHH), or the IEEE format hexadecimal notation (HH-HH-HH-HH-HH-HH) when you apply the **mac-address-format ieee** parameter.

Enter the **arp log** command without the optional **mac-address-format ieee** parameter specified for MAC addresses in the ARP log output to use the default hexadecimal notation (HHHH.HHHH.HHHH).

Enter the **arp log mac-address-format ieee** command for MAC addresses in the ARP log output to use the IEEE standard format hexadecimal notation (HH-HH-HH-HH-HH-HH).

Use the **no** variant of this command (**no arp log**) without the optional **mac-address-format ieee** parameter specified to disable ARP logging on the switch

Use the **no** variant of this command with the optional **mac-address-format ieee** parameter specified (**no arp log mac-address-format ieee**) to disable IEEE standard format hexadecimal notation (HH-HH-HH-HH-HH-HH) and revert to the default hexadecimal notation (HHHH.HHHH.HHHH) for MAC addresses in the ARP log output.

To display ARP log messages use the **show log | include ARP_LOG** command.

Examples To enable ARP logging and use the default hexadecimal notation (HHHH.HHHH.HHHH), use the following commands:

```
awplus# configure terminal
awplus(config)# arp log
```

To disable ARP logging on the switch of MAC addresses displayed using the default hexadecimal notation (HHHH.HHHH.HHHH), use the following commands:

```
awplus# configure terminal
awplus(config)# no arp log
```

To enable ARP logging and to specify that the MAC address in the log message is displayed in the standard IEEE format hexadecimal notation (HH-HH-HH-HH-HH-HH), use the following commands:

```
awplus# configure terminal
awplus(config)# arp log mac-address-format ieee
```

To disable ARP logging on the switch of MAC addresses displayed using the standard IEEE format hexadecimal notation (HH-HH-HH-HH-HH-HH), and revert to the use of the default hexadecimal notation (HHHH.HHHH.HHHH) instead, use the following commands:

```
awplus# configure terminal
awplus(config)# no arp log mac-address-format ieee
```

To display ARP log messages, use following command:

```
awplus# show log | include ARP_LOG
```

Output Below is example output from the `show log | include ARP_LOG` command after enabling ARP logging displaying default hexadecimal notation MAC addresses (HHHH.HHHH.HHHH) using the `arp log` command.

Figure 23-1: Example output from the `show log | include ARP_LOG` command

```
awplus#configure terminal
awplus(config)#arp log
awplus(config)#exit
awplus#show log | include ARP_LOG
2010 Apr 6 06:21:01 user.notice awplus HSL[1007]: ARP_LOG port1.0.7 vlan1 add
0013.4078.3b98 (192.168.2.4)
2010 Apr 6 06:22:30 user.notice awplus HSL[1007]: ARP_LOG port1.0.7 vlan1 del
0013.4078.3b98 (192.168.2.4)
2010 Apr 6 06:23:26 user.notice awplus HSL[1007]: ARP_LOG port1.0.7 vlan1 add
0030.940e.136b (192.168.2.20)
2010 Apr 6 06:23:30 user.notice awplus IMISH[1830]: show log | include ARP_LOG
```

Output Below is example output from the `show log | include ARP_LOG` command after enabling ARP logging displaying IEEE standard format hexadecimal notation MAC addresses (HH-HH-HH-HH-HH-HH) using the `arp log mac-address-format ieee` command.

Figure 23-2: Example output from the `show log | include ARP_LOG` command

```
awplus#configure terminal
awplus(config)#arp log mac-address-format ieee
awplus(config)#exit
awplus#show log | include ARP_LOG
2010 Apr  6 06:25:28 user.notice awplus HSL[1007]: ARP_LOG port1.0.7 vlan1 add 00-
17-9a-b6-03-69 (192.168.2.12)
2010 Apr  6 06:25:30 user.notice awplus HSL[1007]: ARP_LOG port1.0.7 vlan1 add 00-
03-37-6b-a6-a5 (192.168.2.10)
2010 Apr  6 06:26:53 user.notice awplus HSL[1007]: ARP_LOG port1.0.7 vlan1 del 00-
30-94-0e-13-6b (192.168.2.20)
2010 Apr  6 06:27:31 user.notice awplus HSL[1007]: ARP_LOG port1.0.7 vlan1 del 00-
17-9a-b6-03-69 (192.168.2.12)
2010 Apr  6 06:28:09 user.notice awplus HSL[1007]: ARP_LOG port1.0.7 vlan1 del 00-
03-37-6b-a6-a5 (192.168.2.10)
2010 Apr  6 06:28:14 user.notice awplus IMISH[1830]: show log | include ARP_LOG
awplus#
```

Below are the parameters in output of the `show log | include ARP_LOG` command with an ARP log message format of `<ARP_LOG> <port number> <VLAN ID> <Operation> <MAC> <IP>` after `<date> <time> <severity> <hostname> <program name>` information.

Table 23-1: Parameters in output of the `show log | include ARP_LOG` command

Parameter	Description
<code><ARP_LOG></code>	Indicates ARP log entry information follows <code><date> <time> <severity> <hostname> <program name></code> log information.
<code><port number></code>	Indicates switch port number for the ARP log entry.
<code><VLAN ID></code>	Indicates the VLAN ID for the ARP log entry.
<code><Operation></code>	Indicates 'add' if the ARP log entry displays an ARP addition. Indicates 'del' if the ARP log entry displays an ARP deletion.
<code><MAC></code>	Indicates the MAC address for the ARP log entry, either in the default hexadecimal notation (HHHH.HHHH.HHHH) or in the IEEE standard format hexadecimal notation (HH-HH-HH-HH-HH-HH) as specified with the <code>arp log</code> or the <code>arp log mac-address-format ieee</code> command.
<code><IP></code>	Indicates the IP address for the ARP log entry.

Validation Commands `show running-config`

Related Commands `show log`

clear arp-cache

This command deletes the dynamic ARP entries from the ARP cache.

To display the entries in the ARP cache, use the [show arp](#) command. To remove static ARP entries, use the [no arp <ip-addr>](#) command.

Syntax `clear arp-cache`

Mode Privileged Exec

Example To clear the dynamic ARP entries, use the command:

```
awplus# clear arp-cache
```

Related Commands [arp-aging-timeout](#)
[arp \(IP address MAC address\)](#)
[show arp](#)

debug ip packet interface

The **debug ip packet interface** command enables IP packet debug and is controlled by the **terminal monitor** command.

- If the optional **icmp** keyword is specified then ICMP packets are shown in the output.

The **no** variant of this command disables the **debug ip interface** command.

Syntax

```
debug ip packet interface {<interface-name>|all}
    [address <ip-address>|verbose|hex|arp|udp|tcp|icmp]
no debug ip packet interface [<interface-name>]
```

Parameter	Description
<interface-name>	Specify a single layer 3 interface name (not a range of interfaces) This keyword can be specified as either all or as a single layer 3 interface to show debugging for either all interfaces or a single interface.
all	Specify all layer 3 interfaces on the switch.
<ip-address>	Specify an IPv4 address. If this keyword is specified, then only packets with the specified IP address as specified in the ip-address placeholder are shown in the output.
verbose	Specify verbose to output more of the IP packet. If this keyword is specified then more of the packet is shown in the output.
hex	Specify hex to output the IP packet in hexadecimal. If this keyword is specified, then the output for the packet is shown in hex.
arp	Specify arp to output ARP protocol packets. If this keyword is specified, then ARP packets are shown in the output.
udp	Specify udp to output UDP protocol packets. If this keyword is specified then UDP packets are shown in the output.
tcp	Specify tcp to output TCP protocol packets. If this keyword is specified, then TCP packets are shown in the output.
icmp	Specify icmp to output ICMP protocol packets. If this keyword is specified, then ICMP packets are shown in the output.

Mode Privileged Exec and Global Configuration

Examples To turn on ARP packet debugging on `vlan1`, use the command:

```
awplus# debug ip packet interface vlan1 arp
```

To turn on all packet debugging on all interfaces on the switch, use the command:

```
awplus# debug ip packet interface all
```

To turn on TCP packet debugging on `vlan1` and IP address `192.168.2.4`, use the command:

```
awplus# debug ip packet interface vlan1 address 192.168.2.4 tcp
```

To turn off IP packet interface debugging on all interfaces, use the command:

```
awplus# no debug ip packet interface
```

To turn off IP packet interface debugging on interface `vlan2`, use the command:

```
awplus# no debug ip packet interface vlan2
```

Related Commands

- `no debug all`
- `show debugging ip packet`
- `tcpdump`
- `terminal monitor`
- `undebug ip packet interface`

debug ip irdp

This command enables debugging of ICMP Router Discovery Protocol (IRDP) events and messages on your device. IRDP debugging is disabled by default.

- If **event** is specified, then IRDP events related debugging will be enabled.
- If **nsm** is specified, then IRDP processing of NSM messages debugging will be enabled.
- If **receive** is specified, then IRDP input packet processing debugging will be enabled.
- If **send** is specified, then IRDP output packet processing debugging will be enabled.
- If **both** is specified, then both IRDP input and output packet processing debugging will be enabled.
- If **detail** is specified, then both IRDP detailed input and output packet processing debugging will be enabled.
- If **all** is specified, then all IRDP debugging will be enabled.

The **no** variant of this command disables IRDP debugging.

- Note that setting **detail** also sets **both**, so if you set **detail**, the output will show "packet debugging mode is all". Negating any packet debug mode will switch **detail** off.

Syntax `debug ip irdp {event|nsm|receive|send|both|detail|all}`
`no debug ip irdp {event|nsm|receive|send|both|detail|all}`

Parameter	Description
<code>event</code>	Enables debugging of IRDP events.
<code>nsm</code>	Enables debugging of IRDP processing of NSM messages.
<code>receive</code>	Enables debugging of IRDP input packet processing.
<code>send</code>	Enables debugging of IRDP output packet processing.
<code>both</code>	Enables debugging of both IRDP input and output packet processing.
<code>detail</code>	Enables detailed debugging of both IRDP input and output packet processing.
<code>all</code>	Enables all IRDP debugging types.

Default IRDP protocol debugging is disabled by default

Mode Privileged Exec and Global Configuration

Examples To enable IRDP input packet process debugging, use the following command:

```
awplus# debug ip irdp receive
```

To disable all IRDP debugging, use the following command:

```
awplus# no debug ip irdp all
```

Related Commands

- ip irdp
- router ip irdp
- show ip irdp
- undebg ip irdp

ip address

This command sets a static IP address on an interface. To set the primary IP address on the interface, specify only **ip address <ip-address/m>**. This overwrites any configured primary IP address. To add additional IP addresses on this interface, use the **secondary** parameter. You must configure a primary address on the interface before configuring a secondary address.

Note  Use **show running-config** interface not **show ip interface brief** when you need to view a secondary address configured on an interface. **show ip interface brief** will only show the primary address not a secondary address for an interface.

The **no** variant of this command removes the IP address from the interface. You cannot remove the primary address when a secondary address is present.

Syntax

```
ip address <ip-addr/prefix-length> [secondary [label <label>]]
no ip address <ip-addr/prefix-length> [secondary]
no ip address
```

Parameter	Description
<ip-addr/prefix-length>	The IPv4 address and prefix length you are assigning to the interface.
label	Adds a user-defined description of the secondary IP address.
<label>	A user-defined description of the secondary IP address. Valid characters are any printable character and spaces.

Mode Interface Configuration for a VLAN interface.

Examples To add the primary IP address 10.10.10.50/24 to the interface vlan3, use the following commands:

```
awplus# configure terminal
awplus(config)# interface vlan3
awplus(config-if)# ip address 10.10.10.50/24
```

To add the secondary IP address 10.10.11.50/24 to the same interface, use the following commands:

```
awplus# configure terminal
awplus(config)# interface vlan3
awplus(config-if)# ip address 10.10.11.50/24 secondary
```

Related Commands [show ip interface brief](#)
[show running-config interface](#)

ip domain-list

This command adds a domain to the DNS list. Domain are appended to incomplete host names in DNS requests. Each domain in this list is tried in turn in DNS lookups. This list is ordered so that the first entry you create is checked first.

If there are no domains in the DNS list, then your device uses the domain specified with the [ip domain-name](#) command. If any domain exists in the DNS list, then the device does not use the domain set using the [ip domain-name](#) command.

The **no** variant of this command deletes a domain from the list.

Syntax `ip domain-list <domain-name>`
`no ip domain-list <domain-name>`

Parameter	Description
<code><domain-name></code>	Domain string, for example "company.com".

Mode Global Configuration

Example To add the domain `example.net` to the DNS list, use the following commands:

```
awplus# configure terminal
awplus(config)# ip domain-list example.net
```

Related Commands [ip domain-lookup](#)
[ip domain-name](#)
[show ip domain-list](#)

ip domain-lookup

This command enables the DNS client on your device. This allows you to use domain names instead of IP addresses in commands. The DNS client resolves the domain name into an IP address by sending a DNS enquiry to a DNS server, specified with the [ip name-server](#) command.

The client is enabled by default. However, it does not attempt DNS enquiries unless there is a DNS server configured.

The **no** variant of this command disables the DNS client. The client will not attempt to resolve domain names. You must use IP addresses to specify hosts in commands.

Syntax `ip domain-lookup`
`no ip domain-lookup`

Mode Global Configuration

Examples To enable the DNS client on your device, use the following commands:

```
awplus# configure terminal
awplus(config)# ip domain-lookup
```

To disable the DNS client on your device, use the following commands:

```
awplus# configure terminal
awplus(config)# no ip domain-lookup
```

Related Commands [ip domain-list](#)
[ip domain-name](#)
[ip name-server](#)
[show hosts](#)
[show ip name-server](#)

ip domain-name

This command sets a default domain for the DNS. The DNS client appends this domain to incomplete host-names in DNS requests.

If there are no domains in the DNS list (created using the [ip domain-list](#) command) then your device uses the domain specified with this command. If any domain exists in the DNS list, then the device does not use the domain configured with this command.

When your device is using its DHCP client for an interface, it can receive Option 15 from the DHCP server. This option replaces the domain name set with this command. See [Chapter 75, Dynamic Host Configuration Protocol \(DHCP\) Introduction](#) for more information about DHCP and DHCP options.

The **no** variant of this command removes the domain-name previously set by this command.

Syntax `ip domain-name <domain-name>`
`no ip domain-name <domain-name>`

Parameter	Description
<code><domain-name></code>	Domain string, for example "company.com".

Mode Global Configuration

Example To configure the domain name, enter the following commands:

```
awplus# configure terminal
awplus(config)# ip domain-name company.com
```

Related Commands [ip domain-list](#)
[show ip domain-list](#)
[show ip domain-name](#)

ip directed-broadcast

Use this command to enable flooding of directed broadcast packets into a directly connected subnet. If this command is configured on a VLAN interface, then directed broadcasts received on other VLAN interfaces, destined for the subnet on this VLAN, will be flooded to the subnet broadcast address of this VLAN.

Use the **no** variant of this command to disable **ip directed-broadcast**. When this feature is disabled using the **no** variant of this command, directed broadcasts are not forwarded.

Syntax `ip directed-broadcast`
`no ip directed-broadcast`

Default The **ip directed-broadcast** command is disabled by default.

Mode Interface Configuration for a VLAN interface.

Usage IP directed-broadcast is enabled and disabled per VLAN interface. When enabled a directed broadcast packet is forwarded to an enabled VLAN interface if received on another subnet.

An IP directed broadcast is an IP packet whose destination address is a broadcast address for some IP subnet, but originates from a node that is not itself part of that destination subnet. When a directed broadcast packet reaches a switch that is directly connected to its destination subnet, that packet is flooded as a broadcast on the destination subnet.

The **ip directed-broadcast** command controls the flooding of directed broadcasts when they reach target subnets. The command affects the final transmission of the directed broadcast on its destination subnet. It does not affect the transit unicast routing of IP directed broadcasts. If directed broadcast is enabled for an interface, incoming directed broadcast IP packets intended for the subnet assigned to interface will be flooded as broadcasts on that subnet.

If the **no ip directed-broadcast** command is configured for an interface, directed broadcasts destined for the subnet where the interface is attached will be dropped instead of broadcast.

Examples To enable **ip directed-broadcast**, to flood broadcast packets out via the `vlan2` interface, enter the following commands:

```
awplus# configure terminal
awplus(config)# interface vlan2
awplus(config-if)# ip directed-broadcast
```

To disable **ip directed-broadcast**, disabling the flooding of broadcast packets via `vlan2`, enter the following commands:

```
awplus# configure terminal
awplus(config)# interface vlan2
awplus(config-if)# no ip directed-broadcast
```

Related Commands [ip forward-protocol udp](#)
[ip helper-address](#)
[show running-config](#)

ip forwarding

This command enables IP forwarding on your device. When enabled, your device routes IP packets.

The **no** variant of this command disables IP forwarding on your device. Even when IP forwarding is not enabled, the device can still work as an IP host; in particular, it can be managed by IP-based applications, such as SNMP, Telnet and SSH.

Syntax `ip forwarding`
`no ip forwarding`

Default IP forwarding is enabled by default.

Mode Global Configuration

Examples To enable your device to route IP packets, use the commands:

```
awplus# configure terminal
awplus(config)# ip forwarding
```

To stop your device from routing IP packets, use the commands

```
awplus# configure terminal
awplus(config)# no ip forwarding
```

Related Commands [show ip interface brief](#)

ip forward-protocol udp

This command enables you to control which UDP broadcasts will be forwarded to the helper address(es). A UDP broadcast will only be forwarded if the destination UDP port number in the packet matches one of the port numbers specified using this command.

Refer to the IANA site (www.iana.org) for a list of assigned UDP port numbers for protocols to forward using **ip forward-protocol udp**.

Use the **no** variant of this command to remove a port number from the list of destination port numbers that are used as the criterion for deciding if a given UDP broadcast should be forwarded to the IP helper address(es).

Syntax `ip forward-protocol udp <port>`
`no ip forward-protocol udp <port>`

Parameter	Description
<port>	UDP Port Number

Default The **ip forward-protocol udp** command is not enabled by default.

Mode Global Configuration

Usage Combined with the [ip helper-address command on page 23.20](#) in interface mode, the **ip forward-protocol udp** command in global configuration mode allows control of which protocols (destination port numbers) are forwarded. The **ip forward-protocol udp** command configures protocols for forwarding, and the **ip helper-address** command configures the destination address(es).

Note  The types of UDP broadcast packets that the switch will forward are ONLY those specified by the **ip forward-protocol** command(s). There are not other UDP packet types that the IP helper process forwards by default.

Note  The **ip forward-protocol udp** command does not support BOOTP / DHCP Relay. The **ip dhcp-relay** command must be used instead. For this reason, you may not configure UDP ports 67 and 68 with the **ip forward-protocol udp** command. See [“Configuring the DHCP Relay Agent” on page 75.6 in Chapter 75, Dynamic Host Configuration Protocol \(DHCP\) Introduction](#) for information about DHCP Relay.

Examples To configure forwarding of packets on UDP port 53 (DNS protocol), use the following commands:

```
awplus# configure terminal
awplus(config)# ip forward-protocol udp 53
```

To delete UDP port 53 (DNS protocol) from the UDP ports that the switch forwards, use the following commands:

```
awplus# configure terminal
```

```
awplus(config)# no ip forward-protocol udp 53
```

**Validation
Commands** show running-config

Related Commands ip helper-address
 ip directed-broadcast

ip gratuitous-arp-link

This command sets the Gratuitous ARP time limit for all switchports. The time limit restricts the sending of Gratuitous ARP packets to one Gratuitous ARP packet within the time in seconds. The range is <0-300> seconds, where 0 disables all sending, and the default is 5 seconds.

Note  Previously this command specified time between Gratuitous ARP packets to prevent excessive Gratuitous ARP packet transmission in the case of a link flapping up and down. Now this command specifies time between sequences of Gratuitous ARP packets, and time between individual Gratuitous ARP packets occurring in a sequence, to allow legacy support for older devices and interoperability between other devices that are not ready to receive and forward data until several seconds after linkup.

Additionally, jitter has been applied to the delay following linkup, so Gratuitous ARP packets applicable to a given port are spread over a period of 1 second so are not all sent at once. Remaining Gratuitous ARP packets in the sequence occur after a fixed delay from the first one.

Syntax `ip gratuitous-arp-link <0-300>`
`no ip gratuitous-arp-link`

Parameter	Description
<0-300>	Specify the minimum time between sequences of Gratuitous ARPs and the fixed time between Gratuitous ARPs occurring in a sequence, in seconds.

Default The default Gratuitous ARP time limit for all switchports is 5 seconds.

Mode Global Configuration

Usage Every switchport will send a sequence of 3 Gratuitous ARP packets to each VLAN that the switchport is a member of, whenever the switchport moves to the forwarding state. The first Gratuitous ARP packet is sent 1 second after the switchport becomes a forwarding switchport. The second and third Gratuitous ARP packets are each sent after the time period specified by the Gratuitous ARP time limit.

Additionally, the Gratuitous ARP time limit specifies the minimum time between the end of one Gratuitous ARP sequence and the start of another Gratuitous ARP sequence. When a link is flapping, the switchport's state is set to forwarding several times. The Gratuitous ARP time limit is imposed to prevent Gratuitous ARP packets from being sent undesirably often.

Specifying 0 for the Gratuitous ARP time limit disables the sending of Gratuitous ARP packets.

Examples To disable the sending of Gratuitous ARP packets, use the commands:

```
awplus# configure terminal
awplus(config)# ip gratuitous-arp-link 0
```

To restrict the sending of Gratuitous ARP packets to one every 20 seconds, use the commands:

```
awplus# configure terminal
awplus(config)# ip gratuitous-arp-link 20
```

Validation Commands `show running-config`

ip helper-address

This command adds a forwarding destination address for IP Helper to enable forwarding of User Datagram Protocol (UDP) broadcasts on an interface.

Use the **no** variant of this command to disable the forwarding of broadcast packets to specific addresses.

Syntax `ip helper-address <ip-addr>`
`no ip helper-address <ip-addr>`

Parameter	Description
<code><ip-addr></code>	Forwarding destination IP address for IP Helper

Default The destination address for the `ip helper-address` command is not configured by default.

Mode Interface Configuration for a VLAN interface.

Usage Combined with the `ip forward-protocol udp` command in global configuration mode, the `ip helper-address` command in interface mode allows control of which protocols (destination port numbers) are forwarded. The `ip forward-protocol udp` command configures protocols for forwarding, and the `ip helper-address` command configures the destination address(es).

The destination address can be a unicast address or a subnet broadcast address. The UDP destination port is configured separately with the `ip forward-protocol udp` command. If multiple destination addresses are registered then UDP packets are forwarded to each IP address added to an IP Helper. Up to 32 destination addresses may be added using IP Helper.

Note  The types of UDP broadcast packets that the switch will forward are ONLY those specified by the `ip forward-protocol` command(s). There are not other UDP packet types that the IP helper process forwards by default.

Note  The `ip helper-address` command does not support BOOTP / DHCP Relay. The `ip dhcp-relay` command must be used instead. For this reason, you may not configure UDP ports 67 and 68 with the `ip forward-protocol` command. See [“Configuring the DHCP Relay Agent” on page 75.6 in Chapter 75, Dynamic Host Configuration Protocol \(DHCP\) Introduction](#) for information about DHCP Relay.

Examples The following example defines IPv4 address 192.168.1.100 as an IP Helper destination address to which to forward UDP broadcasts received on `vlan2`:

```
awplus# configure terminal
awplus(config)# interface vlan2
awplus(config-if)# ip helper-address 192.168.1.100
```

The following example removes IPv4 address 192.168.1.100 as an IP Helper destination address to which to forward UDP broadcasts received on `vlan2`:

```
awplus# configure terminal
awplus(config)# interface vlan2
awplus(config-if)# no ip helper-address 192.168.1.100
```

Validation Commands `show running-config`

Related Commands `ip forward-protocol udp`
`ip directed-broadcast`

ip irdp

This command enables ICMP Router Discovery advertising on an interface. However, the interface does not send or process Router Discovery messages until at least one IP address is configured on the interface with the [ip address](#) command.

The **no** variant of this command disables ICMP Router Discovery advertisements on an IP interface. All transmitting and processing of Router Discovery messages ceases immediately on the interface.

Syntax `ip irdp`
`no ip irdp`

Mode Interface Configuration for a VLAN interface.

Examples To enable Router Discovery advertisements on `vlan4`, use the commands:

```
awplus# configure terminal
awplus(config)# interface vlan4
awplus(config-if)# ip irdp
```

To disable Router Discovery advertisements on `vlan4`, use the commands:

```
awplus# configure terminal
awplus(config)# interface vlan4
awplus(config-if)# no ip irdp
```

Related Commands `show ip irdp`
`show ip irdp interface`

ip irdp address preference

When multiple routers connected to a LAN are all sending Router Discovery advertisements, hosts need to be able to choose the best router to use. Therefore the IRDP defines a preference value to place in the Router Discovery advertisements. Hosts choose the router with the highest preference value.

This command sets the preference value to include in Router Discovery advertisements sent for the specified IP address.

The **no** variant of this command sets the preference for a specific address to the default of 0.

Syntax `ip irdp address <ip-address> preference <0-2147483647>`
`no ip irdp address <ip-address> preference`

Parameter	Description
<code><ip-address></code>	The IP address to be advertised with the specified preference value.
<code><0-2147483647></code>	The preference value advertised. A higher number increases the preference level for this address.

Default The default preference value is 0.

Mode Interface Configuration for a VLAN interface.

Examples To set the preference value to 3000 for the address 192.168.1.1 advertised on `vlan5`, use the commands:

```
awplus# configure terminal
awplus(config)# interface vlan5
awplus(config-if)# ip irdp address 192.168.1.1 preference 3000
```

To set the preference value to the default of 0 for the address 192.168.1.1 advertised on `vlan5`, use the commands:

```
awplus# configure terminal
awplus(config)# interface vlan5
awplus(config-if)# no ip irdp address 192.168.1.1 preference
```

Related Commands [ip irdp](#)
[ip irdp preference](#)
[show ip irdp interface](#)

ip irdp broadcast

This command configures broadcast Router Discovery advertisements on an interface. The interface sends IRDP advertisements with the broadcast address (255.255.255.255) as the IP destination address.

The **no** variant of this command configures multicast Router Discovery advertisements on an interface. The interface sends IRDP advertisements with the all-system multicast address (224.0.0.1) as the IP destination address.

Syntax `ip irdp broadcast`
`no ip irdp broadcast`

Mode Interface Configuration for a VLAN interface.

Examples To enable broadcast Router Discovery advertisements on `vlan13`, use the commands:

```
awplus# configure terminal
awplus(config)# interface vlan13
awplus(config-if)# ip irdp broadcast
```

To enable multicast Router Discovery advertisements on `vlan13`, use the commands:

```
awplus# configure terminal
awplus(config)# interface vlan13
awplus(config-if)# no ip irdp broadcast
```

Related Commands [ip irdp](#)
[ip irdp multicast](#)
[show ip irdp interface](#)

ip irdp holdtime

This command sets the maximum length of time that the advertised addresses are to be considered as valid router addresses by hosts.

The **no** variant of this command resets the holdtime back to the default of 1800 seconds.

Syntax `ip irdp holdtime <0-9000>`
`no ip irdp holdtime <0-9000>`

Parameter	Description
<code><0-9000></code>	The holdtime value in seconds of addresses advertised.

Default The IRDP holdtime is set to 1800 seconds (30 minutes) by default.

Mode Interface Configuration for a VLAN interface.

Examples To set the holdtime value of addresses advertised on `vlan2` to 4000 seconds, use the commands:

```
awplus# configure terminal
awplus(config)# interface vlan2
awplus(config-if)# ip irdp holdtime 4000
```

To set the holdtime value of addresses advertised on `vlan2` back to the default, use the commands:

```
awplus# configure terminal
awplus(config)# interface vlan2
awplus(config-if)# no ip irdp holdtime
```

Related Commands `show ip irdp interface`

ip irdp lifetime

This command sets the maximum length of time that hosts should consider the Router Discovery advertised addresses as valid router addresses. If you change the lifetime value, also change the **maxadvertisementinterval** and the **minadvertisementinterval** to maintain the following ratios:

```
lifetime=3 x maxadvertisementinterval
minadvertisementinterval=0.75 x maxadvertisementinterval
```

This command is synonymous with the **ip irdp hostname <0-9000>** command.

The **no** variant of this command sets the lifetime back to the default of 1800 seconds.

Syntax `ip irdp lifetime <0-9000>`
`no ip irdp lifetime`

Parameter	Description
<0-9000>	Lifetime value in seconds of the advertised addresses.

Default The lifetime value is 1800 seconds.

Mode Interface Configuration for a VLAN interface.

Examples To set the lifetime value to 4000 seconds for addresses advertised on `vlan6`, use the commands:

```
awplus# configure terminal
awplus(config)# interface vlan6
awplus(config-if)# ip irdp lifetime 4000
```

To set the lifetime value to the default of 1800 seconds for addresses advertised on `vlan6`, use the commands:

```
awplus# configure terminal
awplus(config)# interface vlan6
awplus(config-if)# no ip irdp lifetime
```

Related Commands `ip irdp`
`ip irdp maxadvertinterval`
`ip irdp minadvertinterval`
`show ip irdp interface`

ip irdp maxadvertinterval

This command sets the maximum time allowed between sending router advertisements from the interface. If you change the **maxadvertinterval** value, also change the **lifetime** and the **minadvertinterval** to maintain the following ratios:

```
lifetime=3 x maxadvertinterval
```

```
minadvertinterval=0.75 x maxadvertinterval
```

You cannot set the maximum advertisement interval below the minimum interval. If you are lowering the maximum interval to a value below the current minimum interval, you must change the minimum value first.

The **no** variant of this command sets the **maxadvertinterval** back to the default of 600 seconds.

Syntax `ip irdp maxadvertinterval <4-1800>`
`no ip irdp maxadvertinterval`

Parameter	Description
<4-1800>	The maximum time, in seconds, between Router Discovery advertisements.

Default The IRDP maximum advertisement interval is set to 600 seconds (10 minutes) by default.

Mode Interface Configuration for a VLAN interface.

Examples To set the maximum interval between Router Discovery advertisements on `vlan7` to 950 seconds, use the commands:

```
awplus# configure terminal
awplus(config)# interface vlan7
awplus(config-if)# ip irdp maxadvertinterval 950
```

To set the maximum interval between advertisements on `vlan7` back to the default, use the commands:

```
awplus# configure terminal
awplus(config)# interface vlan7
awplus(config-if)# no ip irdp maxadvertinterval
```

Related Commands [ip irdp](#)
[ip irdp lifetime](#)
[ip irdp minadvertinterval](#)
[show ip irdp interface](#)

ip irdp minadvertinterval

This command sets the minimum time allowed between sending router advertisements from the interface. If you change the **minadvertinterval** value, also change the **lifetime** and the **maxadvertinterval** to maintain the following ratios:

```
lifetime=3 x maxadvertinterval
minadvertinterval=0.75 x maxadvertinterval
```

You cannot set the minimum advertisement interval above the maximum interval. If you are raising the minimum interval to a value above the current maximum interval, you must change the maximum value first.

The **no** variant of this command sets the **minadvertinterval** back to the default of 450 seconds.

Syntax

```
ip irdp minadvertinterval <3-1800>
no ip irdp minadvertinterval
```

Parameter	Description
<3-1800>	The minimum time between advertisements in seconds.

Default The IRDP minimum advertisement interval is set to 450 seconds (7.5 minutes) by default.

Mode Interface Configuration for a VLAN interface

Examples To set the minimum interval between advertisements on `vlan4` to 900 seconds, use the commands:

```
awplus# configure terminal
awplus(config)# interface vlan4
awplus(config-if)# ip irdp minadvertinterval 900
```

To set the minimum interval between advertisements on `vlan4` back to the default of 450 seconds, use the commands:

```
awplus# configure terminal
awplus(config)# interface vlan4
awplus(config-if)# no ip irdp minadvertinterval
```

Related Commands

- [ip irdp](#)
- [ip irdp lifetime](#)
- [ip irdp maxadvertinterval](#)
- [show ip irdp interface](#)

ip irdp multicast

This command configures multicast Router Discovery advertisements on an interface. The interface sends IRDP advertisements with the all-system multicast address (224.0.0.1) as the IP destination address.

The **no** variant of this command configures broadcast Router Discovery advertisements on an interface. The interface sends IRDP advertisements with the broadcast address (255.255.255.255) as the IP destination address.

The multicast address is the default IP destination address for Router Discovery advertisements.

Syntax `ip irdp multicast`
`no ip irdp multicast`

Mode Interface Configuration for a VLAN interface.

Examples To enable multicast Router Discovery advertisements on **vlan5**, use the commands:

```
awplus# configure terminal
awplus(config)# interface vlan5
awplus(config-if)# ip irdp multicast
```

To enable broadcast Router Discovery advertisements on **vlan5**, use the commands:

```
awplus# configure terminal
awplus(config)# interface vlan5
awplus(config-if)# no ip irdp multicast
```

Related Commands `ip irdp`
`ip irdp broadcast`
`show ip irdp interface`

ip irdp preference

When multiple routers connected to a LAN are all sending Router Discovery advertisements, hosts need to be able to choose the best router to use. Therefore the IRDP defines a preference value to place in the Router Discovery advertisements. Hosts choose the router with the highest preference value.

This command sets the preference value to include in Router Discovery advertisements sent for the specified interface.

When this command is used, all IP addresses on the interface are assigned the same preference value, except the addresses that have specific preference value assignment using the command [ip irdp address preference](#).

The **no** variant of this command sets the preference value to the default of 0.

Syntax `ip irdp preference <0-2147483647>`
`no ip irdp preference`

Parameter	Description
<code><0-2147483647></code>	The preference value for the interface. A higher number increases the preference level for addresses on the specific interface.

Default The default preference value is 0.

Mode Interface Configuration for a VLAN interface.

Examples To set the preference of addresses advertised on `vlan6` to 500, use the commands:

```
awplus# configure terminal
awplus(config)# interface vlan6
awplus(config-if)# ip irdp preference 500
```

To set the preference value for addresses on `vlan6` back to the default of 0, use the commands:

```
awplus# configure terminal
awplus(config)# interface vlan6
awplus(config-if)# no ip irdp preference
```

Related Commands [ip irdp](#)
[ip irdp address preference](#)
[show ip irdp interface](#)

ip local-proxy-arp

This command allows you to stop MAC address resolution between hosts within a private VLAN edge interface. Local Proxy ARP works by intercepting ARP requests between hosts within a subnet and responding with your device's own MAC address details instead of the destination host's details. This stops hosts from learning the MAC address of other hosts within its subnet through ARP requests.

Local Proxy ARP ensures that devices within a subnet cannot send traffic that bypasses layer 3 routing on your device. This lets you monitor and filter traffic between hosts in the same subnet, and enables you to have control over which hosts may communicate with one another.

When Local Proxy ARP is operating on an interface, your device does not generate or forward any ICMP-Redirect messages on that interface. This command does not enable proxy ARP on the interface; see the [ip proxy-arp](#) command for more information on enabling proxy ARP.

The **no** variant of this command disables Local Proxy ARP to stop your device from intercepting and responding to ARP requests between hosts within a subnet. This allows the hosts to use MAC address resolution to communicate directly with one another. Local Proxy ARP is disabled by default.

Syntax `ip local-proxy-arp`
`no ip local-proxy-arp`

Default Local proxy ARP is disabled by default

Mode Interface Configuration for a VLAN interface.

Examples To enable your device to apply Local Proxy ARP on the interface `vlan7`, use the following commands:

```
awplus# configure terminal
awplus(config)# interface vlan7
awplus(config-if)# ip local-proxy-arp
```

To disable your device to apply Local Proxy ARP on the interface `vlan7`, use the following commands:

```
awplus# configure terminal
awplus(config)# interface vlan7
awplus(config-if)# no ip local-proxy-arp
```

Related Commands [ip proxy-arp](#)
[show arp](#)
[show running-config](#)

ip name-server

This command adds the IP address of a DNS server to the device's list of servers. The DNS client on your device sends DNS queries to devices on this list when trying to resolve a DNS hostname. Your device cannot resolve a hostname until you have added at least one server to this list. There is no limit on the number of servers you can add to the list.

When your device is using its DHCP client for an interface, it can receive Option 6 from the DHCP server. This option appends the name server list with more DNS servers. See [Chapter 75, Dynamic Host Configuration Protocol \(DHCP\) Introduction](#) for more information about DHCP and DHCP options.

The **no** variant of this command removes the DNS server from the list of servers.

Syntax `ip name-server <ip-addr>`
`no ip name-server <ip-addr>`

Parameter	Description
<code><ip-addr></code>	The IP address to be advertised with the specified preference value.

Mode Global Configuration

Example To allow your device to send DNS queries to a DNS server at 10.10.10.5, use the commands:

```
awplus# configure terminal
awplus(config)# ip name-server 10.10.10.5
```

Related Commands [ip domain-list](#)
[ip domain-lookup](#)
[ip domain-name](#)
[show ip name-server](#)

ip proxy-arp

This command enables Proxy ARP responses to ARP requests on an interface. When enabled, your device intercepts ARP broadcast packets and substitutes its own physical address for that of the remote host. By responding to the ARP request, your device ensures that subsequent packets from the local host are directed to its physical address, and it can then forward these to the remote host.

Your device responds only when it has a specific route to the address being requested, excluding the interface route that the ARP request arrived from. It ignores all other ARP requests. See the [ip local-proxy-arp](#) command about enabling your device to respond to other ARP messages.

The **no** variant of this command disables Proxy ARP responses on an interface. Proxy ARP is disabled by default.

Syntax `ip proxy-arp`
`no ip proxy-arp`

Default Proxy ARP is disabled by default.

Mode Interface mode for a VLAN interface.

Examples To enable your device to Proxy ARP on the interface `vlan13`, use the following commands:

```
awplus# configure terminal
awplus(config)# interface vlan13
awplus(config-if)# ip proxy-arp
```

To disable your device to Proxy ARP on the interface `vlan13`, use the following commands:

```
awplus# configure terminal
awplus(config)# interface vlan13
awplus(config-if)# no ip proxy-arp
```

Related Commands [arp](#) (IP address MAC address)
[ip local-proxy-arp](#)
[show arp](#)
[show running-config](#)

ip redirects

This command enables ICMP redirects for an interface. ICMP redirects are enabled by default. Use the **no** variant of this command to disable the sending of ICMP redirects for an interface.

Syntax `ip redirects`
`no ip redirects`

Default ICMP Redirects are enabled by default.

Mode Interface Configuration

Usage ICMP redirect messages are used to notify hosts that a better route is available to a destination. ICMP redirects are used when a packet is routed into the switch on the same interface that the packet is routed out of the switch. ICMP redirects are also used when the subnet or network of the source address is on the same subnet or network as the next-hop address for a packet.

Use the **ip redirects** command to allow the sending of ICMP redirects whenever the switch receives a packet that is routed on the same interface that the packet was sent on.

Use the **no** variant of this command to disallow the sending of ICMP redirects whenever the switch receives a packet that is routed on the same interface that the packet was sent on.

Examples To enable ICMP redirects on interface vlan2, use the following commands:

```
awplus# configure terminal
awplus(config)# interface vlan2
awplus(config-if)# ip redirects
```

To disable ICMP redirects on interface vlan2, use the following commands:

```
awplus# configure terminal
awplus(config)# interface vlan2
awplus(config-if)# no ip redirects
```

Related Commands [show running-config](#)

optimistic-nd

Use this command to enable the optimistic neighbor discovery feature for both IPv4 and IPv6.

Use the **no** variant of this command to disable the optimistic neighbor discovery feature.

Syntax `optimistic-nd`
`no optimistic-nd`

Default The optimistic neighbor discovery feature is enabled by default.

Mode Interface Configuration for a VLAN interface.

Usage The optimistic neighbor discovery feature allows the switch, after learning an IPv4 or IPv6 neighbor, to refresh the neighbor before the neighbor is deleted from the hardware L3 switching table. The neighbor is put into the 'stale' state in the software switching table if it is not refreshed, then the 'stale' neighbors are deleted from the hardware L3 switching table.

The optimistic neighbor discovery feature enables the switch to sustain L3 traffic switching to a neighbor without interruption. Without the optimistic neighbor discovery feature enabled L3 traffic is interrupted when a neighbor is 'stale' and is then deleted from the L3 switching table.

If a neighbor receiving optimistic neighbor solicitations does not answer optimistic neighbor solicitations with neighbor advertisements, then the neighbor will be put into the 'stale' state, and subsequently deleted from both the software and the hardware L3 switching tables.

Examples To enable the optimistic neighbor discovery feature on `vlan100`, use these commands:

```
awplus# configure terminal
awplus(config)# interface vlan100
awplus(config-if)# optimistic-nd
```

To disable the optimistic neighbor discovery feature on `vlan100`, use these commands:

```
awplus# configure terminal
awplus(config)# interface vlan100
awplus(config-if)# no optimistic-nd
```

**Validation
Commands** `show running-config`

ping

This command sends a query to another IPv4 host (send Echo Request messages).

Syntax ping [ip] <host> [broadcast] [df-bit {yes|no}] [interval <0-128>] [pattern <hex-data-pattern>] [repeat {<1-2147483647>|continuous}] [size <36-18024>] [source <ip-addr>] [timeout <1-65535>] [tos <0-255>]

Parameter	Description
<host>	The destination IP address or hostname.
broadcast	Allow pingging of a broadcast address.
df-bit	Enable or disable the do-not-fragment bit in the IP header.
interval <0-128>	Specify the time interval in seconds between sending ping packets. The default is 1.
pattern <hex-data-pattern>	Specify the hex data pattern.
repeat	Specify the number of ping packets to send.
<1-2147483647>	Specify repeat count. The default is 5.
continuous	Continuous ping
size <36-18024>	The number of data bytes to send, excluding the 8 byte ICMP header. The default is 56 (64 ICMP data bytes).
source <ip-addr>	The IP address of a configured IP interface to use as the source in the IP header of the ping packet.
timeout <1-65535>	The time in seconds to wait for echo replies if the ARP entry is present, before reporting that no reply was received. If no ARP entry is present, it does not wait.
tos <0-255>	The value of the type of service in the IP header.

Mode User Exec and Privileged Exec

Example

```
awplus# ping 10.10.0.5
```

router ip irdp

This command globally enables ICMP Router Discovery (IRDP) advertisements on your device. However, your device does not send or process IRDP messages until at least one interface is configured to use IP and has had IRDP enabled on the interface with the `ip irdp` command.

The `no` variant of this command globally disables IRDP advertisements on the device. All interfaces immediately stop transmitting and processing Router Discovery messages.

Syntax `router ip irdp`
`no router ip irdp`

Mode Global Configuration

Examples To enable Router Discovery advertisements on your device, use the command:

```
awplus# configure terminal
awplus(config)# router ip irdp
```

To disable Router Discovery advertisements on your device, use the command:

```
awplus# configure terminal
awplus(config)# no router ip irdp
```

Related Commands `ip irdp`
`show ip irdp`

show arp

This command displays the dynamic and static ARP entries in the ARP cache. The ARP cache contains mappings of IP addresses to physical addresses for hosts. To have a dynamic entry in the ARP cache, a host must have used the ARP protocol to access another host.

For information on output options, see [“Controlling “show” Command Output” on page 1.35.](#)

Syntax `show arp`

Mode User Exec and Privileged Exec

Example To display the ARP entries in the ARP cache, use the command:

```
awplus# show arp
```

Output [Figure 23-3: Example output from the show arp command](#)

IP Address	MAC Address	Interface	Port	Type
192.168.2.4	0013.4078.3b98	vlan3	port1.0.7	dynamic
192.168.15.20	0030.940e.136b	vlan3	port1.0.7	dynamic
192.168.17.1	0017.9ab6.0369	vlan3	port1.0.7	dynamic
192.168.18.10	0003.376b.a6a5	vlan3	port1.0.7	dynamic
192.168.18.12	0000.cd23.55c4	vlan3	port1.0.7	dynamic
192.168.21.1	0003.476b.a8a9	vlan3	port1.0.7	dynamic
192.168.26.1	0030.846e.9bc5	vlan3	port1.0.7	dynamic
192.168.27.10	0000.f742.ad10	vlan3	port1.0.7	dynamic
192.168.27.100	0000.daa.fcd24	vlan3	port1.0.7	dynamic
192.168.1.100	00d0.6b04.2a42	vlan2	port1.0.8	static

Table 23-2: Parameters in the output of the show arp command

Parameter	Meaning
IP Address	IP address of the network device this entry maps to.
MAC Address	Hardware address of the network device.
Interface	Interface over which the network device is accessed.
Port	Physical port that the network device is attached to.
Type	Whether the entry is a static or dynamic entry. Static entries are added using the <code>arp (IP address MAC address)</code> command. Dynamic entries are learned from ARP request/reply message exchanges.

Related Commands `arp (IP address MAC address)`
`clear arp-cache`

show debugging ip packet

Use this command to show the IP interface debugging status. IP interface debugging is set using the **debug ip packet interface** command.

For information on output options, see [“Controlling “show” Command Output” on page 1.35.](#)

Syntax show debugging ip packet

Mode Privileged Exec

Example To display the IP interface debugging status when the terminal monitor off, use the command:

```
awplus# terminal no monitor
awplus# show debug ip packet
```

Output Figure 23-4: Example output from the **show debug ip packet** command with **terminal monitor off**

```
IP debugging status:
interface all tcp (stopped)
interface vlan1 arp verbose (stopped)
```

Example To display the IP interface debugging status when the terminal monitor is on, use the command:

```
awplus# terminal monitor
awplus# show debug ip packet
```

Output Figure 23-5: Example output from the **show debug ip packet** command with **terminal monitor on**

```
IP debugging status:
interface all tcp (running)
interface vlan1 arp verbose (running)
```

Related Commands [debug ip packet interface](#)
[terminal monitor](#)

show hosts

This command shows the default domain, domain list, and name servers configured on your device.

For information on output options, see [“Controlling “show” Command Output” on page 1.35.](#)

Syntax show hosts

Mode User Exec and Privileged Exec

Example To display the default domain, use the command:

```
awplus# show hosts
```

Output Figure 23-6: Example output from the **show hosts** command

```
Default domain is mycompany.com
Domain list: company.com
Name/address lookup uses domain service
Name servers are 10.10.0.2 10.10.0.88
```

Related Commands ip domain-list
ip domain-lookup
ip domain-name
ip name-server

show ip domain-list

This command shows the domains configured in the domain list. The DNS client uses the domains in this list to append incomplete hostnames when sending a DNS enquiry to a DNS server.

For information on output options, see [“Controlling “show” Command Output” on page 1.35.](#)

Syntax `show ip domain-list`

Mode User Exec and Privileged Exec

Example To display the list of domains in the domain list, use the command:

```
awplus# show ip domain-list
```

Output Figure 23-7: Example output from the **show ip domain-list** command

```
alliedtelesis.com  
mycompany.com
```

Related Commands [ip domain-list](#)
[ip domain-lookup](#)

show ip domain-name

This command shows the default domain configured on your device. When there are no entries in the DNS list, the DNS client appends this domain to incomplete hostnames when sending a DNS enquiry to a DNS server.

For information on output options, see [“Controlling “show” Command Output” on page 1.35.](#)

Syntax `show ip domain-name`

Mode User Exec and Privileged Exec

Example To display the default domain configured on your device, use the command:

```
awplus# show ip domain-name
```

Output Figure 23-8: Example output from the **show ip domain-name** command

```
alliedtelesis.com
```

Related Commands [ip domain-name](#)
[ip domain-lookup](#)

show ip forwarding

Use this command to display the IP forwarding status.

For information on output options, see [“Controlling “show” Command Output” on page 1.35.](#)

Syntax `show ip forwarding`

Mode User Exec and Privileged Exec

Example

```
awplus# show ip forwarding
```

Output Figure 23-9: Example output from the **show ip forwarding** command

```
awplus#show ip forwarding
IP forwarding is on
```

show ip interface brief

Use this command to display brief information about interfaces and the IP addresses assigned to them. To display information about a specific interface, specify the interface name with the command.

For information on output options, see [“Controlling “show” Command Output” on page 1.35.](#)

Syntax `show ip interface [<interface-list>] [brief]`

Parameter	Description
<code><interface-list></code>	<p>The interfaces to display information about. An interface-list can be:</p> <ul style="list-style-type: none"> ■ an interface, e.g. <code>vlan2</code> ■ a continuous range of interfaces separated by a hyphen, e.g. <code>vlan2-8</code> or <code>vlan2-vlan5</code> ■ a comma-separated list of interfaces or interface ranges, e.g. <code>vlan2, vlan5, vlan8-10</code> <p>The specified interfaces must exist.</p>

Mode User Exec and Privileged Exec

Examples To show brief information for the assigned IP address for interface `port1.0.2` use the command:

```
awplus# show ip interface port1.0.2 brief
```

To show the IP addresses assigned to `vlan2` and `vlan3`, use the command:

```
awplus# show ip interface vlan2-3 brief
```

Output [Figure 23-10: Example output from the show ip interface brief command](#)

Interface	IP-Address	Status	Protocol
port1.0.2	unassigned	admin up	down
vlan1	192.168.1.1	admin up	running
vlan2	192.168.2.1	admin up	running
vlan3	192.168.3.1	admin up	running
vlan8	unassigned	admin up	down.

show ip irdp

This command displays whether IRDP is globally enabled on your device, and the status of the debugging modes.

- If the **debug ip irdp** command has been set with the **detail** parameter then the **both** parameter is also set and the output will show "packet debugging mode is all".

For information on output options, see ["Controlling "show" Command Output" on page 1.35.](#)

Syntax show ip irdp

Mode User Exec and Privileged Exec

Example To display global IRDP configuration, use the command:

```
awplus# show ip irdp
```

Output Figure 23-11: Example output from the **show ip irdp** command

```
IRDP is enabled
event debugging is disabled
nsm debugging is disabled
packet debugging mode is disabled
```

Figure 23-12: Example output from the **show ip irdp** command with **debug ip irdp detail** set

```
IRDP is enabled
event debugging is disabled
nsm debugging is disabled
packet debugging mode is all
```

Figure 23-13: Example output from the **show ip irdp** command with **debug ip irdp both** set

```
IRDP is enabled
event debugging is disabled
nsm debugging is disabled
packet debugging mode is both
```

Related Commands debug ip irdp
router ip irdp

show ip irdp interface

This command displays the configuration of IRDP on all interfaces, or for a specified interface.

For information on output options, see [“Controlling “show” Command Output” on page 1.35.](#)

Syntax `show ip irdp interface [<interface-name>]`

Parameter	Description
<interface-name>	Displays the interface status and configuration details of the specified interface.

Mode User Exec and Privileged Exec

Example To display the IRDP configuration for `vlan4`, use the command:

```
awplus# show ip irdp interface vlan4
```

Output Figure 23-14: Example output from the `show ip irdp interface` command

```
vlan13 is up, line protocol is up
ICMP Router Discovery Protocol
  Sending mode          multicast
  Router Lifetime      1350 seconds
  Default Preference   0
  Min Adv Interval     450 seconds
  Max Adv Interval     600 seconds
  Next advertisement in 551 seconds
  Non default prefix preferences
    192.168.1.1        preference      25000

  In packets          0                Out packets          3
  In bad packets      0                Out bad packets     0
  In good packets     0                Out good packets    3
  In ignored packets  0
```

Table 23-3: Parameters in the output of the **show ip irdp interface** command

Parameter	Description
Sending mode	Whether this interface is sending broadcast or multicast router advertisements. This means the destination IP address of router advertisements will be either the multicast address 224.0.0.1, or the broadcast address 255.255.255.255.
Router Lifetime	The lifetime value set for router advertisements sent from this interface. This is the maximum time that other devices should treat the advertised address as valid.
Default Preference	The preference value for IP addresses as default router addresses, relative to other router addresses on the same subnet. This preference value is used for all IP addresses on this interface, except for those listed under the heading "non default prefix preferences".
Min Adv Interval	Minimum time allowed between sending router advertisements from this interface.
Max Adv Interval	Maximum time allowed between sending router advertisements from this interface.
Non default prefix preferences	List of the IP addresses on this interface that have been set with a specific router preference value. These addresses use the preference value listed beside them, rather than the interface's default preference value.
In packets	The total number of packets received by IRDP on this interface. IRDP processes all ICMP packets received on this interface.
Out packets	The number of packets sent by IRDP on this interface.
In bad packets	The number of packets received by IRDP that it has discarded because they do not conform or corrupted.
Out bad packets	The number of packets that IRDP generated but failed to send to the network layer.
In good packets	The number of packets received and processed by IRDP.
Out good packets	The number of packets generated and successfully sent by IRDP.
In ignored packets	The number of incoming packets ignored, like ICMP packets other than IRDP.

Related Commands [ip irdp](#)
[show ip irdp](#)

show ip name-server

This command displays the list of DNS servers your device sends DNS requests to. This is a static list configured using the [ip name-server](#) command.

For information on output options, see [“Controlling “show” Command Output” on page 1.35](#).

Syntax `show ip name-server`

Mode User Exec and Privileged Exec

Example To display the list of DNS servers that your device sends DNS requests to, use the command:

```
awplus# show ip name-server
```

Output [Figure 23-15: Example output from the `show ip name-server` command](#)

```
Nameservers:
 10.10.0.123
 10.10.0.124
```

Related Commands [ip domain-lookup](#)
[ip name-server](#)

tcpdump

Use this command to start a tcpdump, which gives the same output as the Unix-like `tcpdump` command to display TCP/IP traffic. Press `<ctrl> + c` to stop a running tcpdump.

Syntax `tcpdump <line>`

Parameter	Description
<code><line></code>	Specify the dump options. For more information on the options for this placeholder see URL http://www.tcpdump.org/tcpdump_man.html

Mode Privileged Exec

Example To start a tcpdump running to capture IP packets, enter the command:

```
awplus# tcpdump ip
```

Output Figure 23-16: Example output from the `tcpdump` command

```
03:40:33.221337 IP 192.168.1.1 > 224.0.0.13: PIMv2, Hello,
length: 34
1 packets captured
2 packets received by filter
0 packets dropped by kernel
```

Related Commands `debug ip packet interface`

traceroute

Use this command to trace the route to the specified IPv4 host.

Syntax `traceroute {<ip-addr> | <hostname>}`

Parameter	Description
<code><ip-addr></code>	The destination IPv4 address. The IPv4 address uses the format A.B.C.D.
<code><hostname></code>	The destination hostname.

Mode User Exec and Privileged Exec

Example

```
awplus# traceroute 10.10.0.5
```

undebug ip packet interface

This command applies the functionality of the [no debug ip packet interface](#) command on page 23.8.

undebug ip irdp

This command applies the functionality of the [no debug ip irdp](#) command on page 23.10.

Chapter 24: IPv6 Introduction



Introduction.....	24.2
Overview.....	24.2
IPv6 Addresses and Prefixes.....	24.3
Address types.....	24.3
IPv6 Headers.....	24.5
The Internet Control Message Protocol (ICMPv6).....	24.8
IPv6 Routing.....	24.10
Integration of IPv4 and IPv6.....	24.11
IPv6 on your Switch.....	24.11
Enabling IPv6.....	24.11
The 6bone Network.....	24.11

Introduction

This chapter describes the main features of IPv6, the switch's implementation of IPv6 and how to configure and operate IPv6 on the switch.

This chapter describes the following IPv6 features:

- linking together networks that run IPv6.
- allowing address autoconfiguration of hosts connected to the switch.

Overview

IPv6 is the next generation of the Internet Protocol (IP). It has primarily been developed to solve the problem of the eventual exhaustion of the IPv4 address space, but also offers other enhancements. IPv6 addresses are 16 bytes long, in contrast to IPv4's 4 byte addresses. Other features of IPv6 include:

- Address structure improvements:
 - « globally unique addresses with more levels of addressing hierarchy to reduce the size of routing tables
 - « autoconfiguration of addresses by hosts
 - « improved scalability of multicast routing by adding a "scope" field to multicast addresses
 - « a new type of address, the "anycast address", which sends packets to any one of a group of devices
- Removes the need for packet fragmentation en-route, by dynamic determination of the largest packet size that is supported by every link in the path. A link's MTU (Maximum Transmission Unit) must be at least 1280 bytes, compared with 576 bytes for IPv4.
- Includes a Traffic Class that allow packets to be labelled with an appropriate priority. If the network becomes congested, the lowest priority packets are dropped.
- Includes Flow labels that indicate to intermediate switches and routers that packets are part of a flow, and that a particular flow requires a particular type of service. This feature enables, for example, real-time processing of data streams. It also increases routing speed because the forwarding router need only check the flow label, not the rest of the header. The handling indicated by the flow label can be done by the IPv6 Hop-by-Hop header, or by a separate protocol such as RSVP.
- Mandatory authentication and data integrity protocols through IPsec. IPsec is optional in IPv4.

IPv6 Addresses and Prefixes

IPv6 addresses are hexadecimal, and are made up of eight pairs of octets separated by colons. An example of a valid address is **2001:0db8:0000:0000:0260:0000:97ff:64aa**. In the interests of brevity, addresses can be abbreviated in two ways:

- Leading zeros can be omitted, so this address can be written as **2001:db8:0:0:0:260:0:97ff:64aa**.
- Consecutive zeros can be replaced with a double colon, so this address can be written as **2001:db8::260:0:97ff:64a**. Note that a double colon can replace any number of consecutive zeros, but an address can contain only one double colon.

Like IPv4 addresses, a proportion of the leftmost bits of the IPv6 address can be used to indicate the subnet, rather than a single node. This part of the address is called the *prefix*. Prefixes provide the equivalent functionality to a subnet mask in IPv4, allowing a subnet to be addressed, rather than a single node. If a prefix is specified, the IPv6 address is followed by a slash and the number of bits that represent the prefix. For example, **2001::/16** indicates that the first 16 bits (**2001**) of the address **2001:0:0:0:0:0:0:0** represent the prefix.

Like IPv4 addresses, IPv6 addresses are attached to interfaces.

Note RFC 3849 allocates the prefix **2001:0db8::/32** for documentation purposes.



Address types

IPv6 supports the following address types:

- Unicast
- Multicast
- Anycast

Unicast addresses

A unicast address is attached to a single interface and delivers packets only to that interface.

The following special addresses have been defined:

- IPv4-compatible and IPv4-mapped addresses. IPv4-compatible addresses are used to tunnel IPv6 packets across an IPv4 network. IPv4-mapped addresses are used by an IPv6 host to communicate with an IPv4 host. The IPv6 host addresses the packet to the mapped address.
- Link-local addresses can be used on the local network on which the interface is attached. The link-local prefix is **fe80::/10**. Different interfaces on a device may have the same link-local address. The switch will automatically generate a link-local address for all interfaces that are using IPv6. Commands entered to configure link-local addresses that match any automatically generated link-local addresses by the switch will not be executed. Enter the **show ipv6 interface** command to display automatically generated link-local

addresses not shown in the **running-config**. Automatically generated link-local addresses contain the last six hexadecimal numbers of the MAC address for a given interface.

- The Loopback address, consisting of `::1`, which is the equivalent of the IPv4 loopback address, and allows a host to send packets to itself.
- The Unspecified address, consisting of `::`, which is the equivalent of the IPv4 unspecified address, and is used as a source address by hosts during the autoconfiguration process.

Multicast addresses

IPv6 multicast addresses provide the equivalent functionality to broadcast addresses in IPv4. Broadcast addresses are not supported in IPv6. A multicast address identifies a group of interfaces, and packets are sent to all interfaces in that group.

Among the special addresses that have been defined are addresses that allow multicasting to:

- All interfaces on a particular host (`ff01::1`)
- All nodes on a local network (`ff01::2`)
- All routers on the local link (`ff02::2`)
- All routers on the local site (`ff05::2`).

Anycast addresses

An *anycast* address is a unicast address that is attached to more than one interface. If a packet is sent to an anycast address it is delivered to the nearest interface with that address, with the definition of "nearest" depending on the protocol used for routing. If the protocol is RIPv6, the nearest interface is the one that is the shortest number of hops away.

Anycast addresses can be assigned to routers only, and packets cannot originate from an anycast address. A router must be configured to know that it is using an anycast address because the address format cannot be distinguished from that of a unicast address.

Only one anycast address has been predefined: the subnet-router address. The subnet-router address sends messages to the nearest router on a subnet and consists of the subnet's prefix followed by zeros.

IPv6 Headers

The basic unit of data sent through an internet is called a *packet* in IPv6. A packet consists of a *header* followed by the *data*. The following figure shows the IPv6 packet.

Figure 24-1: IPv6 packet

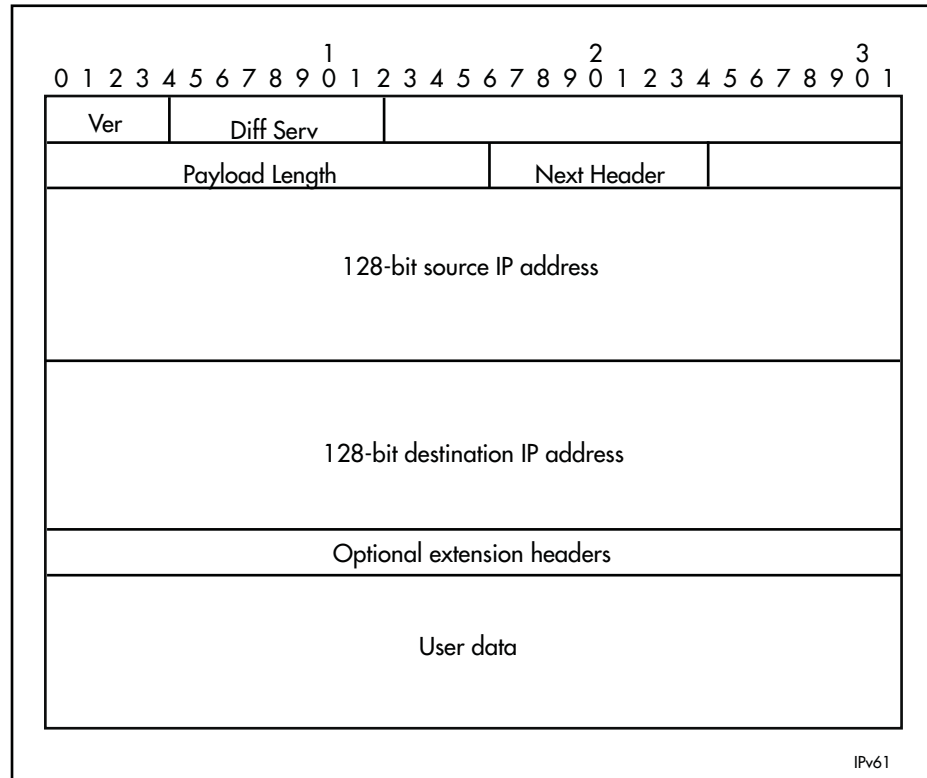

Table 24-1: IPv6 packet - Field Description

Field	Function
Ver	Version of the IP protocol that created the packet. For IPv6, this field has a value of 6.
Differentiated Services	8-bit value that contains the 6-bit DSCP and is used to prioritize traffic as part of a Quality of Service system. For more information, see “Differentiated Services Architecture” on page 52.4 . Additional information can be found in RFC 2474, <i>Definition of the Differentiated Services Field (DS Field) in the IPv4 and IPv6 Headers</i> .
Flow Label	20-bit value that indicates the data flow to which this packet belongs. This flow may be handled in a particular way.
Payload Length	Length of the user data portion of the packet. If the data payload is larger than 64 kB, the length is given in the optional “Jumbo Payload” header and the Payload Length header is given a value of zero.

Table 24-1: IPv6 packet - Field Description (cont.)

Field	Function
Next Header	<p>Number that indicates the type of header that immediately follows the basic IP header. This header type may be an optional IPv6 extension header, a relevant IPv4 option header, or another protocol, such as TCP or ICMPv6.</p> <p>The IPv6 extension header values are:</p> <ul style="list-style-type: none"> 0 (Hop-by-Hop Options Header) 43 (IPv6 Routing Header) 44 (IPv6 Fragment Header) 50 (Encapsulating Security Payload) 51 (IPv6 Authentication Header) 59 (No Next Header) 60 (Destination Options Header)
Hop Limit	Field that is the equivalent of the IPv4 Time To Live field, measured in hops.
Source IP address	128-bit IPv6 address of the sender.
Destination IP address	128-bit IPv6 address of the recipient.
Optional extension headers	Headers for less-frequently used information.
User data	Payload.

Basic IPv6 header structure

The headers contain information necessary to move the packet across the internet. They must be able to cope with missing and duplicated packets as well as possible fragmentation (and reassembly) of the original packet.

IPv6 headers are twice as long as IPv4 headers (40 bytes instead of 20 bytes) and contain four times the address space size (128 bits instead of 32 bits).

They no longer contains the header length, identification, flags, fragment offset, and header checksum fields. Some of these options are placed in extension headers. The Time To Live field is replaced with a hop limit, and the IPv4 Type of Service field is replaced with a Differentiated Services field. The Differentiated Services field contains the DSCP bits, used in a Quality of Service (QoS) regime. The following table explains IPv4 header fields that changed in IPv6.

Changed Field	Description
Type of Service	The type of service that a connection should receive is indicated in IPv6 by the Flow Label field in the IPv6 header.
Fragmentation information (the Identification field, the Flags field and the Fragment Offset field)	In most cases fragmentation does not occur in IPv6. If it does, packets are fragmented at their source and not en route. Therefore, the fragmentation information is contained in an extension header to reduce the size of the basic IPv6 header.
Header Checksum	This option has not been provided in IPv6. This is because transport protocols implement checksums and because of the availability of the IPsec authentication header (AH) in IPv6.
Options	Extension headers handle all the optional values associated with IPv6 packets. The biggest advantage of this scheme is that the size of the basic IP header is a constant.

Extension headers

IPv6 implements many of the less commonly used fields in the IPv4 header (or their equivalents) as extension headers, which are placed after the basic IPv6 header. The length of each header must be a multiple of 8 bytes.

The first extension header is identified by the Next Header field in the basic IPv6 header. Any subsequent extension headers are identified by an 8-bit "Next Header" value at the beginning of the preceding extension header.

IPv6 nodes that originate packets are required to place extension headers in a specific order:

1. The basic IPv6 header. This must come immediately before the extension headers.
2. The Hop-by-Hop header. This specifies options that must be examined by every node in the routing path.
3. A Destination Options header. This is used to specify options to be processed by the first destination or final destination. The destination options header is the only extension header that may be present more than once in the IPv6 packet.
4. The Routing header. This enables a static path to be specified for the packet, if the dynamically-determined path is undesirable.
5. The Fragment header. This indicates that the source node has fragmented the packet, and contains information about the fragmentation.
6. The Authentication header (AH). This verifies the integrity of the packet and its headers.

7. The Encapsulating Security Payload (ESP) header. This encrypts a packet and verifies the integrity of its contents.
8. The Upper Layer Protocol header. This indicates which protocol a higher layer (such as the transport layer) is to process the packet with (for example, TCP).

The Internet Control Message Protocol (ICMPv6)

The Internet Control Message Protocol, ICMPv6, provides a mechanism for error reporting and route discovery and diagnostics. It also conveys information about multicast group membership, a function that is carried out by the Internet Group Management Protocol (IGMP) in IPv4, and performs address resolution, which the Address Resolution Protocol (ARP) performs in IPv4.

Significant aspects of ICMPv6 include neighbor discovery, which enables one device in a network to find out about other nearby devices; and stateless address autoconfiguration, which allows a device to dynamically determine its own IPv6 address.

ICMPv6 is also used to support the Ping v6 (*Packet Internet Groper*) and Trace route v6 functions that are used to verify the connections between networks and network devices. Ping is used to test the connectivity between two network devices to determine whether each network device can “see” the other device. Trace route is used to discover the route used to pass packets between two systems running the IP protocol.

Both of these functions operate almost identically in IPv4 and IPv6. For more information, see [“Ping” on page 22.15](#).

Neighbor discovery

Neighbor discovery is an ICMPv6 function that enables a router or a host to identify other devices on its links. This information is then used in address autoconfiguration, to redirect a node to use a more appropriate router if necessary, and to maintain reachability information with its neighbors.

The IPv6 Neighbor Discovery protocol is similar to a combination of the IPv4 protocols ARP, ICMP Router Discovery and ICMP Redirect.

The following table describes packet types involved with neighbor discovery.

Packet Type	Description
router solicitation	Packet in which a host sends out a request for routers to generate advertisements.
router advertisement	Allows routers to advertise their presence and other network parameters. A router sends an advertisement packet in response to a solicitation packet from a host.
neighbor solicitation	Packet in which a node sends a packet to determine the link layer address of a neighbor or to verify that a neighbor is still active.
neighbor advertisement	A response to a neighbor solicitation packet. These packets are also used to notify neighbors of link layer address changes.
redirect	Informs hosts of a better first hop.

To comply with Section 6.2.1 of RFC 2461, *IPv6 Neighbor Discovery*, the router does not generate router advertisements by default. See [“Neighbor discovery” on page 24.8](#) for instructions about enabling advertisements.

The following table explains packet types and services.

Packet Type	Description
address resolution	A method for carrying out address autoconfiguration, and is achieved using the Neighbor Solicitation Message and the Neighbor Advertisement Message.
router and prefix discovery	On connection to a link, a node needs to know the address of a router that the node can use to reach the rest of the world. The node also needs to know the prefix (or prefixes) that define the range of IP addresses on its link that it can reach without going through a router. Routers use ICMP to convey this information to hosts, by means of router advertisements. The message may have an option attached (the <i>source link address</i> option), which enables the receiving node to respond directly to the router, without performing a neighbor solicitation.
immediate information	The configuration of a router includes a defined frequency at which unsolicited advertisements are sent. If a node wants to obtain information about the nearest router immediately, rather than waiting for the next unsolicited advertisement, the node can send a router solicitation message. Each router that receives the solicitation message sends a router advertisement specifically to the node that sent the solicitation.
redirection	If a node is aware of more than one router that it can use to connect to wider networks, the router to which it sends packets by default does not always represent the most desirable route. ICMPv6 uses the redirect packet to communicate a more effective path to the node.
Neighbor Unreachability Detection (NUD)	A node may issue solicitation requests to determine whether a path is still viable, or may listen in on acknowledgement packets of higher-layer protocols, such as TCP. If the node determines that a path is no longer viable, it attempts to establish a new link to the neighbor, or to re-establish the previous link. NUD can be used between any two devices in the network, independent of whether the devices are acting as hosts or routers.

Stateless address autoconfiguration

Stateless address autoconfiguration allows an IPv6-aware device to be plugged into a network without manual configuration with an IP address. This plug and play functionality results in networks that are easier to set up and modify, and simplifies the process of shifting to use a new Internet Service Provider (ISP).

Stateless address autoconfiguration is achieved in a series of steps. Routers and hosts perform the first three steps, which autoconfigure a link-local address. A global address is autoconfigured in the last three steps, which only hosts perform.

On the router or host

1. During system start-up, the node begins autoconfiguration by generating a link-local address for the interface. A link-local address is formed by adding the interface ID to the link-local prefix **fe80::/10** (reference RFC 3513).

Note: *Different interfaces on a device may have the same link-local address. The switch will automatically generate a link-local address for all interfaces that are using IPv6. Commands entered to configure link-local addresses that match any automatically generated link-local addresses by the switch will not be executed. Enter the **show ipv6 interface** command to display automatically generated link-local addresses not shown in*

*the **running-config**. Automatically generated link-local addresses contain the last six hexadecimal numbers of the MAC address for a given interface.*

2. The node then transmits a neighbor solicitation message to this address. If the address is already in use, the node that the address belongs to replies with a neighbor advertisement message. The autoconfiguration process stops and manual configuration of the node is then required.
3. If no neighbor advertisement is received, the node concludes that the address is available and assigns it to the chosen interface.

On the host

1. The node then sends one or more router solicitations to detect if any routers are present. Any routers present responds with a router advertisement.

If no router advertisement is received, the node tries to use DHCP to obtain an address and other configuration information. If no DHCP server responds, the node continues using the link-level address

If a router advertisement is received, this message informs the node how to proceed with the auto configuration process. The prefix from the router advertisement, if received, is added to the link-level address to form the global unicast IP address.

2. This address is then assigned to the network interface.

If routers are present, the node continues to receive router advertisements. The node updates its configuration when there are changes in the router advertisements.

IPv6 Routing

Routing in IPv6 is almost identical to IPv4 routing under CIDR, except that the addresses are 128-bit IPv6 addresses instead of 32-bit IPv4 addresses.

Routing Information Protocol (RIPv6)

RIP is a simple distance vector protocol that defines networks based on how many hops they are from the router. When a network is more than 15 hops away (one hop is one link), it is not included in the routing table.

RIPv6, also referred to as RIPv6 (for "next generation") is similar to RIPv2. Extensions to RIPv2 to support IPv6 are:

- the address field of a routing entry is expanded to 128 bits to allow IPv6 prefixes
- the 32-bit RIPv2 subnet mask field is replaced by an 8-bit prefix length field
- authentication is removed in RIPv6
- the size of a routing packet is no longer arbitrarily limited
- RIPv6 specifies the next hop instead of simply allowing the recipient of the update to set the next hop to the sender of the update.

In RIPv6, each router uses a routing table to keep track of every destination that is reachable throughout the system. Each entry in the routing table contains:

- the IPv6 prefix of the destination
- a metric, which represents the total cost of getting a packet from the router to that destination
- the IPv6 address of the next router along the path to the destination
- a flag to indicate that information about the route has changed recently
- various timers associated with the route.

Integration of IPv4 and IPv6

IPv6 has been designed in such a way that a smooth transition from IPv4 is possible. The most effective way to ensure this is to use a *dual IP stack*. A node configured as a dual stack system has both a 128-bit IPv6 address and a 32-bit IPv4 address, and so can communicate with nodes running IPv4 and those running IPv6.

Another aspect of the transition is to *tunnel* IPv6 packets through an IPv4 network. IPv6 packets are tunnelled simply by encapsulating the IPv6 packet within an IPv4 datagram, and identifying that this datagram is an encapsulated IPv6 packet by giving the datagram a protocol value of 41.

IPv6 on your Switch

This section describes the switch's support for IPv6, and how to configure IPv6 on the switch. Fundamental IPv6 features on the switch are:

Enabling IPv6

The switch's implementation of IPv6 is disabled by default. To enable IPv6 forwarding, use the [ipv6 forwarding command on page 25.3](#).

To display information about IPv6 settings, use the [show ipv6 interface brief command on page 25.15](#).

Because the switch implements IPv6 as a dual stack, implementing IPv6 does not affect IPv4 functionality.

The 6bone Network

The 6bone is an experimental virtual network of nodes that support IPv6 packets, tunnelled together through the existing IPv4 Internet. Most of the nodes are workstations or similar machines, with IPv6-capable operating systems. The theory of tunnelling IPv6 packets over an IPv4 network is outlined in "[Integration of IPv4 and IPv6](#)" on page 24.11.

The 6bone is part of the transition to IPv6. Its purpose is to provide an environment in which IPv6 can be tested and procedures for IPv6 can be developed. When IPv6 is sufficiently developed and being used widely, the 6bone will probably disappear.

Chapter 25: IPv6 Commands



Command List	25.2
clear ipv6 neighbors.....	25.2
ipv6 address	25.2
ipv6 forwarding	25.3
ipv6 nd managed-config-flag	25.4
ipv6 nd other-config-flag	25.5
ipv6 nd prefix	25.6
ipv6 nd ra-interval.....	25.7
ipv6 nd ra-lifetime.....	25.8
ipv6 nd reachable-time	25.9
ipv6 nd suppress-ra.....	25.10
ipv6 neighbor.....	25.11
ipv6 route.....	25.12
ping ipv6.....	25.13
show ipv6 forwarding.....	25.14
show ipv6 interface brief	25.15
show ipv6 neighbors.....	25.15
show ipv6 route.....	25.16
show ipv6 route summary.....	25.17
traceroute ipv6.....	25.18

Command List

This chapter provides an alphabetical reference of commands used to configure IPv6. For more information, see [Chapter 24, IPv6 Introduction](#).

clear ipv6 neighbors

Use this command to clear all dynamic IPv6 neighbor entries.

Syntax `clear ipv6 neighbors`

Mode Privileged Exec

Example

```
awplus# clear ipv6 neighbors
```

ipv6 address

Use this command to set the IPv6 address of a VLAN interface.

Use the **no** variant of this command to remove the address assignment.

Syntax `ipv6 address <ipv6-addr/prefix-length>`

`no ipv6 address <ipv6-addr/prefix-length>`

Parameter	Description
<code><ipv6-addr/prefix-length></code>	Specifies the IPv6 address to be set. The IPv6 address uses the format X:X::X:X/Prefix-Length. The prefix-length is usually set between 0 and 64, or has the value 128.

Mode Interface Configuration for a VLAN interface.

Example To assign the IPv6 address to the interface `vlan2`, use the following commands:

```
awplus# configure terminal
awplus(config)# interface vlan2
awplus(config-if)# ipv6 address 2001:0db8::a2/64
```

Validation Commands `show running-config`
`show ipv6 interface brief`
`show ipv6 route`

ipv6 forwarding

Use this command to turn on IPv6 forwarding.

Use the **no** variant of this command to turn off IPv6 forwarding.

Note  The switch will not apply any IPv6 functionality unless you have allocated it memory resource by using the [platform routingratio command on page 15.28](#).

Syntax `ipv6 forwarding`
`no ipv6 forwarding`

Mode Global Configuration

Example

```
awplus# configure terminal
awplus(config)# ipv6 forwarding
```

ipv6 nd managed-config-flag

Use this command to set the managed address configuration flag, contained within the router advertisement field.

Setting this flag indicates the operation of a stateful autoconfiguration protocol such as DHCPv6 for address autoconfiguration, and that address information (i.e. the network prefix) and other (non-address) information can be requested from the switch.

An unset flag enables hosts receiving the advertisements to use a stateless autoconfiguration mechanism to establish their IPv6 addresses. The default is flag unset.

Use the **no** variant of this command to reset this command to its default of, *flag unset*.

Syntax `ipv6 nd managed-config-flag`
`no ipv6 nd managed-config-flag`

Default Unset

Mode Interface Configuration for a VLAN interface.

Usage Advertisement flags will not be transmitted unless you have applied the [no ipv6 nd suppress-ra command on page 25.10](#). This step is included in the example below.

Example To set the managed address configuration flag on `vlan2`, use the following commands:

```
awplus# configure terminal
awplus(config)# interface vlan2
awplus(config-if)# ipv6 nd managed-config-flag
awplus(config-if)# no ipv6 nd suppress-ra
```

Related Commands [ipv6 nd suppress-ra](#)
[ipv6 nd prefix](#)
[ipv6 nd other-config-flag](#)

ipv6 nd other-config-flag

Use this command to set the **other** stateful configuration flag (contained within the router advertisement field) to be used for IPv6 address auto-configuration. This flag is used to request the router to provide information in addition to providing addresses.

 **Note** Setting the [ipv6 nd managed-config-flag](#) command on page 25.4 implies that the [ipv6 nd other-config-flag](#) will also be set.

Use **no** variant of this command to reset the value to the default.

Syntax `ipv6 nd other-config-flag`
`no ipv6 nd other-config-flag`

Default Unset

Mode Interface Configuration for a VLAN interface.

Usage Advertisement flags will not be transmitted unless you have applied the [no ipv6 nd suppress-ra](#) command on page 25.10. This step is included in the example below.

Example To set the ipv6 other-config-flag on `vlan4`, use the following commands:

```
awplus# configure terminal
awplus(config)# interface vlan4
awplus(config-if)# ipv6 nd other-config-flag
awplus(config-if)# no ipv6 nd suppress-ra
```

Related Commands [ipv6 nd suppress-ra](#)
[ipv6 nd prefix](#)
[ipv6 nd managed-config-flag](#)

ipv6 nd prefix

Use this command to specify the IPv6 prefix information that is advertised by the router advertisement for IPv6 address auto-configuration.

Use **no** parameter with this command to reset the IPv6 prefix.

Syntax

```
ipv6 nd prefix <ipv6-prefix/length> <valid-lifetime>
<preferred-lifetime> [off-link] [no-autoconfig]

no ipv6 nd prefix <ipv6-addr/prefix-length> <valid-lifetime>
<preferred-lifetime> [off-link] [no-autoconfig]
```

Parameter	Description
<ipv6-prefix/length>	The prefix to be advertised by the router. The IPv6 address prefix uses the format X:X::/prefix-length. The prefix-length is usually set between 0 and 64, or has the value 128. The default is X:X::/64.
<valid-lifetime>	The the period during which the specified IPv6 address prefix is valid. This can be set to a value between 0 and 4294967295 seconds. The default is 2592000 (30 days). Note that this period should be set to a value greater than that set for the prefix preferred-lifetime.
<preferred-lifetime>	Specifies the IPv6 prefix preferred lifetime. This is the period during which the IPv6 address prefix is considered a current (undeprecated) value. After this period, the command is still valid but should not be used in new communications. Set to a value between 0 and 4294967295 seconds. The default is 604800 seconds (7 days). Note that this period should be set to a value less than that set for the prefix valid-lifetime.
off-link	Specify the IPv6 prefix off-link flag. The default is <i>flag set</i> .
no-autoconfig	Specify the IPv6 prefix no autoconfiguration flag. Setting this flag indicates that the prefix is not to be used for autoconfiguration. The default is <i>flag set</i> .

Defaults Valid-lifetime default is 2592000 seconds (30 days). Preferred-lifetime default is 604800 seconds (7 days).

Mode Interface Configuration for a VLAN interface.

Usage This command specifies the IPv6 prefix flags that are advertised by the router advertisement message.

Example The following example configures the switch to issue router advertisements on `vlan4`, and advertises the address prefix of `2001:0db8::/64`.

```
awplus# configure terminal
awplus(config)# interface vlan4
awplus(config-if)# ipv6 nd prefix 2001:0db8::/64
```

Related Commands [ipv6 nd suppress-ra](#)

ipv6 nd ra-interval

Use this command to specify the interval between IPv6 Router Advertisements (RA) transmissions.

Use **no** parameter with this command to reset the value to default.

Syntax `ipv6 nd ra-interval <seconds>`
`no ipv6 nd ra-interval <seconds>`

Parameter	Description
<code><seconds></code>	Specifies the number of seconds between IPv6 router advertisements. Valid values are from 3 to 1800 seconds.

Default 600 seconds.

Mode Interface Configuration for a VLAN interface.

Usage Advertisement flags will not be transmitted unless you have applied the [no ipv6 nd suppress-ra command on page 25.10](#) as shown in the example below.

Example To set the advertisements interval on `vlan4` to be 60 seconds, use the following commands:

```
awplus# configure terminal
awplus(config)# interface vlan4
awplus(config-if)# ipv6 nd ra-interval 60
awplus(config-if)# no ipv6 nd suppress-ra
```

Related Commands [ipv6 nd suppress-ra](#)
[ipv6 nd prefix](#)

ipv6 nd ra-lifetime

Use this command to specify the time period that this router can usefully act as a default gateway for the network. Each router advertisement resets this time period.

Use **no** parameter with this command to reset the value to default.

Syntax `ipv6 nd ra-lifetime <seconds>`
`no ipv6 nd ra-lifetime <seconds>`

Parameter	Description
<code><seconds></code>	Time period in seconds. Valid values are from 0 to 9000. Note that you should set this time period to a value greater than the value you have set using the ipv6 nd ra-interval command on page 25.7

Default 1800 seconds

Mode Interface Configuration for a VLAN interface.

Usage This command specifies the lifetime of the current router to be announced in IPv6 Router Advertisements.

Advertisement flags will not be transmitted unless you have applied the [no ipv6 nd suppress-ra command on page 25.10](#). This instruction is included in the example shown below.

Example To set the advertisement lifetime of 8000 seconds on `vlan4`, use the following commands:

```
awplus# configure terminal
awplus(config)# interface vlan4
awplus(config-if)# ipv6 nd ra-lifetime 8000
awplus(config-if)# no ipv6 nd suppress-ra
```

Related Commands [ipv6 nd suppress-ra](#)
[ipv6 nd prefix](#)

ipv6 nd reachable-time

Use this command to specify the reachable time in the router advertisement to be used for detecting reachability of the IPv6 neighbor.

Use the **no** variant of this command to reset the value to default.

Syntax `ipv6 nd reachable-time <milliseconds>`
`no ipv6 nd reachable-time <milliseconds>`

Parameter	Description
<code><milliseconds></code>	Time period in milliseconds. Valid values are from 0 to 3600000. Setting the value of 0 indicates an unspecified reachable-time.

Default 0 milliseconds

Mode Interface Configuration for a VLAN interface.

Usage This command specifies the reachable time of the current router to be announced in IPv6 Router Advertisements.

Advertisement flags will not be transmitted unless you have applied the [no ipv6 nd suppress-ra command on page 25.10](#). This instruction is included in the example shown below.

Example To set the reachable-time in router advertisements on `vlan4` to be 1800000 milliseconds.

```
awplus# configure terminal
awplus(config)# interface vlan4
awplus(config-if)# ipv6 nd reachable-time 1800000
awplus(config-if)# no ipv6 nd suppress-ra
```

Related Commands [ipv6 nd suppress-ra](#)
[ipv6 nd prefix](#)

ipv6 nd suppress-ra

Use this command to inhibit IPv6 Router Advertisement (RA) transmission for the current interface. Router advertisements are used when applying IPv6 stateless auto-configuration.

Use **no** parameter with this command to enable Router Advertisement transmission.

Syntax `ipv6 nd suppress-ra`
`no ipv6 nd suppress-ra`

Default Router Advertisement (RA) transmission is suppressed by default.

Mode Interface Configuration for a VLAN interface.

Example To enable the transmission of router advertisements from interface `vlan4` on the switch, use the following commands:

```
awplus# configure terminal
awplus(config)# interface vlan4
awplus(config-if)# no ipv6 nd suppress-ra
```

Related Commands [ipv6 nd ra-interval](#)
[ipv6 nd prefix](#)

ipv6 neighbor

Use this command to add a static IPv6 neighbor entry.

Use the **no** variant of this command to remove a specific IPv6 neighbor entry.

Syntax `ipv6 neighbor <ipv6-address> <vlan-ID> <mac-address> <port-list>`
`no ipv6 neighbor <ipv6-address> <vlan-ID> <port-list>`

Parameter	Description
<code><ipv6-address></code>	Neighbor's IPv6 address in format <code>x:x::x:x</code>
<code><vlan-ID></code>	The neighbor VLAN name or VID
<code><mac-address></code>	MAC hardware address in hexadecimal notation with the format <code>HHHH.HHHH.HHHH</code>
<code><port-list></code>	The port number, or range.

Mode Global Configuration

Usage Use this command to clear a specific IPv6 neighbor entry. To clear all dynamic address entries, use the [clear ipv6 neighbors command on page 25.2](#).

Example To create a static neighbor entry for IPv6 address `2001:0db8::a2`, on `vlan 4`, MAC address `0000.cd28.0880`, on `port1.0.19`, use the command:

```
awplus# configure terminal
awplus(config)# ipv6 neighbor 2001:0db8::a2 vlan4
0000.cd28.0880 port1.0.19
```

Related Commands [clear ipv6 neighbors](#)

ipv6 route

Use this command to establish the distance for static routes of a network prefix.

Use the **no** variant of this command to disable the distance for static routes of the network prefix.

Syntax

```
ipv6 route <dest-prefix> <dest-prefix/length>
    {<gateway-ip>|<gateway-name>} [<distvalue>]

no ipv6 route <dest-prefix> <dest-prefix/length>
    {<gateway-ip>|<gateway-name>} [<distvalue>]
```

Parameter	Description
<i><dest-prefix/length></i>	Specifies the IP destination prefix. The IPv6 address prefix uses the format X:X::/prefix-length. The prefix-length is usually set between 0 and 64, or has the value 128.
<i><gateway-ip></i>	Specifies the IP gateway (or next hop) address. The IPv6 address uses the format X:X::X/Prefix-Length. The prefix-length is usually set between 0 and 64, or has the value 128.
<i><distvalue></i>	Specifies the administrative distance for the route. Valid values are from 1 to 255.
<i><gateway-name></i>	Specifies the name of the gateway (or next hop) interface

Mode Global Configuration

Example

```
awplus# configure terminal
awplus(config)# ipv6 route 2001:0db8::1/128 myintname 32
```

Validation Commands `show running-config`
`show ipv6 route`

ping ipv6

This command sends a query to another IPv6 host (send Echo Request messages).

Syntax ping ipv6 [*<host>*|*<ipv6-address>*] [repeat {*<1-2147483647>*|*continuous*}] [size *<36-18024>*] [source *<ip-addr>*] [timeout *<1-65535>*]

Parameter	Description
<i><ipv6-addr></i>	The destination IPv6 address. The IPv6 address uses the format X::X:X.
<i><hostname></i>	The destination hostname.
repeat	Specify the number of ping packets to send.
<i><1-2147483647></i>	Specify repeat count. The default is 5.
size <i><36-18024></i>	The number of data bytes to send, excluding the 8 byte ICMP header. The default is 56 (64 ICMP data bytes).
source <i><ip-addr></i>	The IP address of a configured IP interface to use as the source in the IP header of the ping packet.
timeout <i><1-65535></i>	The time in seconds to wait for echo replies if the ARP entry is present, before reporting that no reply was received. If no ARP entry is present, it does not wait.
repeat	Specify the number of ping packets to send.
<i><1-2147483647></i>	Specify repeat count. The default is 5.
continuous	Continuous ping
size <i><36-18024></i>	The number of data bytes to send, excluding the 8 byte ICMP header. The default is 56 (64 ICMP data bytes).
timeout <i><1-65535></i>	The time in seconds to wait for echo replies if the ARP entry is present, before reporting that no reply was received. If no ARP entry is present, it does not wait.

Mode User Exec and Privileged Exec

Example

```
awplus# ping ipv6 2001:0db8::a2
```

Related Commands traceroute ipv6

show ipv6 forwarding

Use this command to display IPv6 forwarding status.

For information on output options, see “Controlling “show” Command Output” on page 1.35.

Syntax show ipv6 forwarding

Mode User Exec and Privileged Exec

Example

```
awplus# show ipv6 forwarding
```

Output Figure 25-1: Example output from the **show ipv6 forwarding** command

```
ipv6 forwarding is on
```

show ipv6 interface brief

Use this command to display brief information about interfaces and the IPv6 address assigned to them. To display information about a specific interface, specify the interface name with the command.

For information on output options, see [“Controlling “show” Command Output” on page 1.35.](#)

Syntax `show ipv6 interface [<interface>] brief`

Parameter	Description
<interface>	The interface to display information about. For instance: <ul style="list-style-type: none"> ■ <code>vlan2</code> The specified interface must exist.

Mode User Exec and Privileged Exec

Examples

```
awplus# show ipv6 interface brief
awplus# show ipv6 interface vlan1 brief
```

Output Figure 25-2: Example output from the `show ipv6 interface brief` command

Interface	IPv6-Address	Status	Protocol
lo	unassigned	admin up	running
vlan1	unassigned	admin up	running
vlan10	2001:db8:a:0:0:c0a8:a0b/64 2001:db8::200:cdff:fe28:84a/64	admin up	running
vlan20	2001:db8::14:0:0:c0a8:140b/64 2001:db8::200:cdff:fe28:84a/64	admin up	running
vlan30	2001:db8::1e:0:0:c0a8:1e0b/64 2001:db8::200:cdff:fe28:84a/64	admin up	running
vlan40	2001:db8::28:0:0:c0a8:280b/64 2001:db8::200:cdff:fe28:84a/64	admin up	running
vlan201	unassigned	admin up	running
vlan250	2001:db8::fa:0:0:c0a8:fa0b/64 2001:db8::200:cdff:fe28:84a/64	admin up	running

Related Commands `show interface brief`

show ipv6 neighbors

Use this command to display all IPv6 neighbors.

For information on output options, see [“Controlling “show” Command Output” on page 1.35.](#)

Syntax `show ipv6 neighbors`

Mode User Exec and Privileged Exec

show ipv6 route

Use this command to display the IPv6 routing table for a protocol or from a particular table.

For information on output options, see [“Controlling “show” Command Output” on page 1.35.](#)

Syntax `show ipv6 route [bgp|connected|database|ospf|rip|static|<ipv6-address>|<ipv6-addr/prefix-length>]`

Parameter	Description
bgp	Displays only the routes learned from Border Gateway Protocol (BGP).
connected	Displays only the routes learned from connected interfaces.
database	Displays only the routing information extracted from the database.
ospf	Displays only the routes learned from Open Shortest Path First (OSPF).
rip	Displays only the routes learned from Routing Information Protocol (RIP).
static	Displays only the static routes you have configured.
summary	Displays summary information from the routing table.
<ipv6-address>	Displays the routes for the specified address in the IP routing table. The IPv6 address uses the format X:X::X:X/Prefix-Length. The prefix-length is usually set between 0 and 64, or has the value 128.
<ipv6-prefix/length>	Displays only the routes for the specified IP prefix. The IPv6 address prefix uses the format X:X::/prefix-length. The prefix-length is usually set between 0 and 64, or has the value 128.

Mode User Exec and Privileged Exec

Example

```
awplus# show ipv6 route
```

Output Figure 25-3: Example output of the **show ipv6 route** command

```
IPv6 Routing Table
Codes: C - connected, S - static, R - RIP, O - OSPF, B - BGP
S   ::/0 [1/0] via 2001::a:0:0:c0a8:a6, vlan10
C   2001:db8::a:0:0:0/64 via ::, vlan10
C   2001:db8::14:0:0:0/64 via ::, vlan20
C   2001:db8::0:0:0:0/64 via ::, vlan30
C   2001:db8::28:0:0:0/64 via ::, vlan40
C   2001:db8::fa:0:0:0/64 via ::, vlan250
C   2001:db8::/64 via ::, vlan250
C   2001:db8::/64 via ::, vlan40
C   2001:db8::/64 via ::, vlan20
C   2001:db8::/64 via ::, vlan10
```

show ipv6 route summary

Use this command to display the summary of the current NSM RIB entries.

For information on output options, see [“Controlling “show” Command Output” on page 1.35.](#)

Syntax `show ipv6 route summary`

Mode User Exec and Privileged Exec

Example

```
awplus# show ipv6 route summary
```

Output Figure 25-4: Example output from the **show ipv6 route summary** command

```
IPv6 routing table name is Default-IPv6-Routing-Table(0)
IPv6 routing table maximum-paths is 4
RouteSource      Networks
connected        4
ospf              5
Total            9
FIB              5
```

Related Commands `show ip route`
`show ip route database`

traceroute ipv6

Use this command to trace the route to the specified IPv6 host.

Syntax `traceroute ipv6 {<ipv6-addr>|<hostname>}`

Parameter	Description
<code><ipv6-addr></code>	The destination IPv6 address. The IPv6 address uses the format X:X::X:X.
<code><hostname></code>	The destination hostname.

Mode User Exec and Privileged Exec

Example

```
awplus# traceroute ipv6 2001:0db8::a2
```

Related Commands [ping ipv6](#)

Chapter 26: IPv6to4 Tunneling Configuration



Introduction.....	26.2
6to4 Automatic Tunnel Configuration.....	26.2
Tunneling Operation.....	26.2
6to4 tunnels operation and configuration summary.....	26.3
Example 6to4 configuration.....	26.4

Introduction

This chapter contains a basic IPv6to4 automatic tunneling configuration example for reference.

To see details on the Tunneling commands used in this sample configuration, or to see the outputs of the Validation commands, refer to [Chapter 27, IPv6to4 Tunneling Commands](#). Links to the Tunneling commands used in the examples are also provided below the examples.

6to4 Automatic Tunnel Configuration

IPv6 transition is required to migrate from IPv4 to IPv6. One method to connect to the global IPv6 network over the existing IPv4 network is called 6to4 automatic tunneling.

Although this method is called '6to4 tunneling', it does not involve discrete point-to-point tunnels. The 'tunneling' in '6to4 tunneling' refers to the fact that the IPv6 packets are encapsulated in IPv4 packets to be 'tunneled' across the IPv4 domain. Hence, '6to4 tunneling' is primarily a scheme for encapsulating IPv6 packets inside IPv4 headers.

Using 6to4 tunneling, you are not required to specify tunnel destination addresses. You only choose the interface that connects the switch to the IPv4 domain, and designate that interface to be the tunnel entry-point. As will be explained below, the IPv4 address that represents the point at which any given IPv6 packet will eventually exit the IPv4 domain is derived from the IPv6 packet itself. Note that the packet's destination IPv6 address itself contains the destination IPv4 address that is used for tunnel encapsulation.

The 6to4 tunneling implementation in AlliedWare Plus™ is used for routing only between IPv6 addresses that are of the form:

```
2002: <valid-IPv4-unicast-address> : XX:XX:XX:XX:XX
```

6to4 tunneling makes use of the fact that for every valid IPv4 unicast address *A.B.C.D*, there is always a corresponding valid IPv6 subnet `2002:<A.B.C.D>::/48`. So, for every global IPv4 address that has been allocated to an organization, there is immediately a global IPv6 subnet `2002:<ipv4-address>::/48` available to that organization.

Tunneling Operation

When an IPv4 interface on the switch is designated as a tunnel entry point, using the [tunnel source command on page 27.5](#) command, an IPv6 tunnel interface is created. The interface is automatically allocated the IPv6 address: `2002:<ipv4-address>::1/128`.

Note  Other implementations of 6to4 tunneling might have a different scheme for deriving the IPv6 address of the tunnel interface, as there is no standardized scheme. This does not cause any interoperability problems, however, as the IPv6 address of the tunnel interface is not actually involved in the routing process.

This tunnel interface is the gateway used by the IPv6 packets to enter the IPv4 domain. As IPv6 packets enter the IPv4 domain, the switch must encapsulate them by pre-pending IPv6 packets with an IPv4 header. The source address of the encapsulating header is the IPv4 address that has been specified by the tunnel source command. The process for determining the destination IP address is explained in more detail below and on the following page.

The key to routing across the IPv4 domain is that there is a connection between the IPv4 address of a tunnel endpoint and the IPv6 subnets which can be reached via that endpoint. The connection is that the tunnel interface with IP address `<ipv4-address>` is considered to be the gateway to all IPv6 subnets within the range `2002:<ipv4-address>::/48`.

When a switch is required to deliver packets, via a tunnel interface, to IPv6 addresses in the range `2002:<ipv4-address>::/48`, the switch knows that the IPv4 address to which the switch must deliver that packet is given by the 17th through 48th bits of the IPv6 destination address. So, the encapsulation process extracts those bits from the IPv6 destination address, and uses them as the IPv4 destination address in the encapsulating header.

For example, if `192.0.2.1` is the IPv4 address of a tunnel endpoint, then the IPv6 subnets in the range `2002:c000:201::/48` are automatically known to be reachable via that tunnel endpoint. If another tunnel endpoint has an IPv6 packet to deliver to `2002:c000:201:6::04:8d`, via the tunnel, then that switch will encapsulate the packet in an IPv4 header with a destination address of `192.0.2.1`.

The corollary to this is the requirement that, to be reachable from other 6to4 networks, the IPv6 VLAN interfaces on the IPv6 side a tunneling switch will need to be configured with IPv6 addresses that are subnetted from the `2002:<ipv4-address>::/48` address.

For example, `2002:<ipv4-address>:1::/64`, `2002:<ipv4-address>:2::/64`, `2002:<ipv4-address>:3::/64`, etc.

Note `2002:<ipv4-address>::/64` cannot be used here, because it conflicts with the automatically configured tunnel address.



6to4 tunnels operation and configuration summary

1. When an IPv4 address is designated as the source address of a tunnel, that tunnel interface is automatically given the IPv6 address `2002:<ipv4-address>::1/128`.
2. The switch does not automatically create any IPv6 routes via that tunnel interface, so you do need to explicitly create a route to direct traffic over the tunnel interface. Typically, you will create a route to `2002::/16` via the tunnel interface. There might be occasions, though, when you want to just create some more restricted routes, within the `2002::/16` range, over the tunnel interface.
3. Once routes have been created that direct traffic over the tunnel interface, it is not necessary to specify nexthop addresses for the individual remote IPv6 subnets that are reachable via the tunnel. The switch will automatically know the IPv4 nexthop via which to reach any IPv6 subnet in the range `2002:<ipv4-address>::/48`.
4. The only IPv6 addresses that can be routed to via the 6to4 tunnels on switches running AlliedWare Plus™ are IPv6 addresses of the form:

```
2002:<valid-IPv4-unicast-address>:xx:xx:xx:xx:xx
```

Example 6to4 configuration

The following example shows the minimum configuration required for 6to4 automatic tunnel configuration. Follow the commands and descriptions in the tables below the sample network:

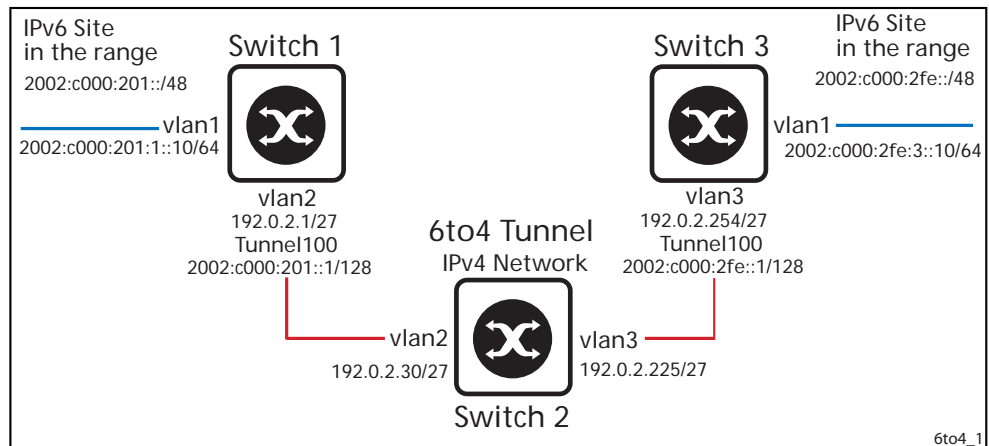

Table 26-1: Example configuration for 6to4 automatic tunneling: Switch 1

<code>awplus#</code>	
<code>configure terminal</code>	Enter the Global Configuration mode.
<code>awplus(config)#</code>	
<code>interface v1an2</code>	Specify the interface (v1an2) and enter the Interface Configuration mode.
<code>awplusa(config-if)#</code>	
<code>ip address 192.0.2.1/27</code>	Set the IPv4 address for the interface (v1an2).
<code>awplus(config-if)#</code>	
<code>exit</code>	Exit Interface Configuration mode and enter Global Configuration mode.
<code>awplus(config)#</code>	
<code>interface v1an1</code>	Specify the interface (v1an1) and enter the Interface Configuration mode.
<code>awplus(config-if)#</code>	
<code>ipv6 address 2002:c000:201:1::10/64</code>	Set the IPv6 address for the interface (v1an1).
<code>awplus(config-if)#</code>	
<code>exit</code>	Exit Interface Configuration mode and enter Global Configuration mode.
<code>awplus(config)#</code>	
<code>ipv6 forwarding</code>	Enable IPv6 routing.
<code>awplus(config)#</code>	
<code>interface tunnel 100</code>	Create a tunnel interface.
<code>awplus(config-if)#</code>	
<code>tunnel mode ipv6ip 6to4</code>	Set the tunnel mode.

Table 26-1: Example configuration for 6to4 automatic tunneling: Switch 1 (cont.)

<code>awplus(config-if)# tunnel source 192.0.2.1</code>	Define the IPv4 address to be used as the source address for the tunnel interface.
<code>awplus(config-if)# exit</code>	Exit Interface Configuration mode and enter Global Configuration mode.
<code>awplus(config)# ipv6 route 2002::/16 tunnel100</code>	Add a route to send traffic for other 6to4 subnets via the tunnel interface.
<code>awplus(config)# router ospf</code>	Create an OSPF routing instance.
<code>awplus(config-router)# router-id 10.70.0.57</code>	Specify a Router ID for the OSPF routing process.
<code>awplus(config-router)# network 192.0.2.0/27 area 0</code>	Enable OSPF routing with a specified Area ID on interfaces with IP addresses within the specified network address. The Area ID used in this case is 0, which specifies the backbone area.

Table 26-2: Example configuration for 6to4 automatic tunneling: Switch 2

<code>awplus# configure terminal</code>	Enter the Global Configuration mode.
<code>awplus(config)# interface vlan2</code>	Specify the interface (v1an2) and enter the Interface Configuration mode.
<code>awplus(config-if)# ip address 192.0.2.30/27</code>	Set the IPv4 address of the interface (v1an2).
<code>awplus(config-if)# exit</code>	Exit Interface mode and enter the Global Configuration mode.
<code>awplus(config)# interface vlan3</code>	Specify the interface (v1an3) and enter the Interface Configuration mode.
<code>awplus(config-if)# ip address 192.0.2.225/27</code>	Set the IPv4 address of the interface (v1an3).
<code>awplus(config-if)# exit</code>	Exit the Interface Configuration mode and enter the Global Configuration mode.
<code>awplus(config)# router ospf</code>	Create an OSPF routing instance.

Table 26-2: Example configuration for 6to4 automatic tunneling: Switch 2 (cont.)

<code>awplus(config-router)#</code>	
<code>router-id 10.70.0.58</code>	Specify a Router ID for the OSPF routing process.
<hr/>	
<code>awplus(config-router)#</code>	
<code>network 192.0.2.0/27 area 0</code>	Enable OSPF routing with a specified Area ID on interfaces with IP addresses with a specified network address. The Area ID used in this case is 0, which specifies the backbone area.
<hr/>	
<code>awplus(config-router)#</code>	
<code>network 192.0.2.224/27 area 0</code>	Enable OSPF routing with a specified Area ID on interfaces with IP addresses within the specified network address. The Area ID used in this case is 0, which specifies the backbone area.

Table 26-3: Example configuration for 6to4 automatic tunneling: Switch 3

<code>awplus(config)#</code>	
<code>interface vlan3</code>	Specify interface (vlan3) and enter the Interface Configuration mode.
<code>awplus(config-if)#</code>	
<code>ip address 192.0.2.254/27</code>	Set the IPv4 address for the interface (vlan3).
<code>awplus(config-if)#</code>	
<code>exit</code>	Exit the Interface Configuration mode and enter the Global Configuration mode.
<code>awplus(config)#</code>	
<code>interface vlan1</code>	Specify the interface (vlan1) and enter the Interface Configuration mode.
<code>awplus(config-if)#</code>	
<code>ipv6 address 2002:c000:2fe:3::10/64</code>	Set the IPv6 address for the interface (vlan1).
<code>awplus(config-if)#</code>	
<code>exit</code>	Exit Interface mode and enter Global Configuration mode.
<code>awplus(config)#</code>	
<code>ipv6 forwarding</code>	Enable IPv6 routing.
<code>awplus(config)#</code>	
<code>interface tunnel 100</code>	Create a tunnel interface.
<code>awplus(config-if)#</code>	
<code>tunnel mode ipv6ip 6to4</code>	Set the tunnel mode.
<code>awplus(config-if)#</code>	
<code>tunnel source 192.0.2.254</code>	Define the IPv4 address to be used as the source address for the tunnel interface.

Table 26-3: Example configuration for 6to4 automatic tunneling: Switch 3 (cont.)

<code>awplus(config-if)#</code>	
<code>exit</code>	Exit Interface Configuration mode and enter Global Configuration mode.
<code>awplus(config)#</code>	
<code>ipv6 route 2002::<ipv4 address="" hex="" in="">::/16 tunnel100</ipv4></code>	Add a route to send traffic for other 6to4 subnets via the tunnel interface.
<code>awplus(config)#</code>	
<code>router ospf</code>	Create an OSPF routing instance.
<code>awplus(config-router)#</code>	
<code>router-id 10.70.0.76</code>	Specify a Router ID for the OSPF routing process.
<code>awplus(config-router)#</code>	
<code>network 192.0.2.224/27 area 0</code>	Enable OSPF routing with a specified Area ID on interfaces with IP addresses within the specified network address. The Area ID used in this case is 0, which specifies the backbone area.

 **Note** The IPv6 address which is automatically assigned to the tunnel interface in this example for **Switch 1** is `2002:<IPv4 address in hex>::1/128`, where **<IPv4 address in hex>** represents the IPv4 address of the tunnel source, converted to hexadecimal.

So, the tunnel interface is the gateway from the IPv4 network to the IPv6 subnet `2002:<IPv4 address in hex>::/48`

Hence, the IPv6 address configured on **vlan1** must be in the subnet `2002:<IPv4 address in hex>::/48`. However, if the address on **vlan1** is given a /64 prefix-length it must differ from the tunnel address somewhere in the 49-64th bits.

For example, in this scenario: **vlan2** IP address (which the tunnel will go over): `192.0.2.1 = c0000201 hex (shown as c000:201 without leading zeros in the example)`. Tunnel 100 IPv6 address will automatically use `2002:c000:0201:0000::1/128` as its IPv6 address.

So, configure the following address on **vlan1**: `2002:c000:0201:<xxxx>::x/6` where **<xxxx>** is anything other than `0000` e.g. `2002:c000:0201:1::10/64`

Names of Commands Used

interface tunnel
 ip address
 ipv6 address
 network area
 router-id
 tunnel mode ipv6ip
 tunnel source

Chapter 27: IPv6to4 Tunneling Commands



Command List	27.2
interface tunnel.....	27.2
tunnel dscp	27.3
tunnel mode ipv6ip.....	27.4
tunnel source.....	27.5
tunnel ttl.....	27.6

Command List

This chapter provides an alphabetical reference of commands used to configure automatic IPv6 tunneling over IPv4. For more information, see [Chapter 26, IPv6to4 Tunneling Configuration](#).

interface tunnel

Use this command to create a new tunnel interface, which is identified by an integer (1-145).

This command is also used to enter interface configuration mode for existing tunnel interfaces.

Use the **no** variant of this command to destroy a previously created tunnel interface.

Syntax `interface tunnel <1-145>`
`no interface tunnel <1-145>`

Default Disabled

Mode Global Configuration

Usage This command creates a new tunnel interface to configure in Interface mode.

Examples

```
awplus# configure terminal
awplus(config)# interface tunnel 100
awplus(config-if)#

awplus# configure terminal
awplus(config)# no interface tunnel 100
awplus(config)#
```

Related Commands `tunnel dscp`
`tunnel mode ipv6ip`
`tunnel source`
`tunnel ttl`

tunnel dscp

Use this command to configure the value (0-63) to use for the IPv4 DSCP (Differentiated Services Code Point) field in the IPv4 header that encapsulates the tunneled IPv6 packets. By default the IPv4 DSCP field value is 0.

Use the **no** variant of this command to reset the IPv4 DSCP field to the default value (0).

Syntax tunnel dscp <0-63>
no tunnel dscp

Default The default IPv4 DSCP field value is 0.

Mode Interface mode

Usage This command controls the IPv4 DSCP field in the IPv4 headers that are prepended (or prefixed) to the tunneled IPv6 packets.

Examples

```
awplus# configure terminal
awplus(config)# interface tunnel 100
awplus(config-if)# tunnel source 192.0.2.1
awplus(config-if)# tunnel dscp 10
```

```
awplus# configure terminal
awplus(config)# interface tunnel 100
awplus(config-if)# tunnel source 192.0.2.1
awplus(config-if)# no tunnel dscp
```

Related Commands interface tunnel
tunnel mode ipv6ip
tunnel source
tunnel ttl

tunnel mode ipv6ip

Use this command to specify the IPv6 transition tunnel mode. In AlliedWare Plus™ 6to4 automatic tunneling is the only tunnel mode supported.

Use the **no** variant of this command to return the mode of the IPv6 transition tunnel to an undefined state.

Syntax tunnel mode ipv6ip 6to4
no tunnel mode

Parameter	Description
6to4	6to4 automatic tunnel mode.

Mode Interface mode

Usage This command specifies a tunnel encapsulation mode for IPv6 in IPv4. Currently only 6to4 automatic tunneling is supported. Future releases may support alternative tunneling modes.

It is a requirement that the mode is set on a tunnel. The tunnel will not be operational until the tunnel mode has been set using the **tunnel mode ipv6ip 6to4** command.

Example

```
awplus# configure terminal
awplus(config)# interface tunnel 100
awplus(config-if)# tunnel source 192.0.2.1
awplus(config-if)# tunnel mode ipv6ip

awplus# configure terminal
awplus(config)# interface tunnel 100
awplus(config-if)# tunnel source 192.0.2.1
awplus(config-if)# no tunnel mode
```

Related Commands interface tunnel
tunnel dscp
tunnel source
tunnel ttl

tunnel source

Use this command to specify the IPv4 source address for packets being encapsulated in the tunnel. It should be the IPv4 address on the interface that attaches the switch for the IPv4 domain through which the IPv6 packets are to be tunneled.

Use the **no** variant of this command to remove a tunnel source address for a tunnel interface.

Syntax `tunnel source <ipv4-addr>`

`no tunnel source`

Parameter	Description
<code><ipv4-addr></code>	IPv4 tunnel source address

Mode Interface mode

Usage This command specifies an IPv4 source address for the tunnel.

Note  There are constraints on the IPv4 source address specified for the tunnel. The IPv4 source address for the tunnel must be the IPv4 address of an interface on the switch, and it must be the interface for carrying the tunnel traffic.

Example

```
awplus# configure terminal
awplus(config)# interface tunnel 100
awplus(config-if)# tunnel source 192.0.2.1

awplus# configure terminal
awplus(config)# interface tunnel 100
awplus(config-if)# no tunnel source
```

Related Commands `interface tunnel`
`tunnel dscp`
`tunnel mode ipv6ip`
`tunnel ttl`

tunnel ttl

Use this command to configure the value to use for the Time to Live (TTL) field in the IPv4 header that encapsulates the tunneled IPv6 packets.

Use the **no** variant of this command to inherit the TTL value from the encapsulated packet.

Syntax `tunnel ttl <1-255>`
`no tunnel ttl`

Default By default the TTL value is inherited from the encapsulated packet.

Mode Interface mode

Usage This command specifies a value of Time to Live (TTL) in the tunnel IPv4 encapsulation header.

Example

```
awplus# configure terminal
awplus(config)# interface tunnel 100
awplus(config-if)# tunnel source 192.0.2.1
awplus(config-if)# tunnel ttl 255
```

```
awplus# configure terminal
awplus(config)# interface tunnel 100
awplus(config-if)# tunnel source 192.0.2.1
awplus(config-if)# no tunnel ttl
```

Related Commands `interface tunnel`
`tunnel dscp`
`tunnel mode ipv6ip`
`tunnel source`

Chapter 28: Routing Protocol Overview



Introduction.....	28.2
RIP.....	28.2
OSPF.....	28.2
BGP.....	28.3
PIM-SM.....	28.4
VRRP.....	28.4

Introduction

This chapter introduces the basic routing protocols supported within the AlliedWare Plus™ Operating System.

RIP

A distance-vector protocol, Routing Information Protocol (RIP) is an Interior Gateway Protocol (IGP) that uses hop counts as its metrics. The AlliedWare Plus™ RIP module supports RFCs 1058 and 1723; the RIPv2 module supports more fields in the RIP packets, and supports security authentication features.

At regular intervals of the routing update timer (a default value of 30 seconds), and at the time of change in the topology, the RIP router sends update messages to other routers. The listening routers update their route table with the new route, and increase the metric value of the path by one (referred to as a hop count). The router recognizes the IP address advertising router as the next hop, then sends the routing updates to other routers. A maximum allowable hop count is 15. If a router reaches a metric value of 16 or more (referred to as infinity), the destination is identified as unreachable. This avoids the indefinite routing loops. The split-horizon and hold-down features are used to avoid propagation incorrect routing information. The route becomes not valid when the route time-out timer expires; it remains in the table until the route-flush timer expires.

OSPF

A link-state routing protocol, Open Shortest Path First (OSPF) is an interior gateway protocol (IGP) that uses the Shortest Path First (SPF) Dijkstra algorithm.

OSPF sends link-state advertisements (LSAs) to all other routers within the same hierarchical area. Data on attached interfaces, metrics used, and other variables, are included in OSPF LSAs. As OSPF routers accumulate link-state data, they use the SPF algorithm to calculate the shortest path to each node.

An Autonomous System (AS) or Domain is defined as a group of networks with common routing infrastructure. OSPF can work in one AS; or receive or send routes from or to different AS systems. Autonomous systems consist of areas. An area is a group of neighboring networks or attached hosts. A router attached to multiple areas with its interfaces is called an Area Border Router (ABR). It creates a distinct topological database: a group of LSAs received from all routers in the same area, for each area. All the routers in the same area have an identical topological database. OSPF routing traffic is restricted in the area because areas are unknown to each other. The routing information is distributed between areas, area border routers, networks, and connected routers by the OSPF backbone.

All backbone OSPF area routers use the same procedures and algorithms to maintain routing information within the backbone that any area router would. The backbone topology is invisible to all routers within an area. The individual area topologies are invisible to the backbone. Sometimes the backbone is not a contiguous area. Virtual links function as if they were direct links, and are configured between backbone routers that share a link to a non-backbone area.

AS border routers running OSPF learn about exterior routes through exterior gateway protocols (EGPs) such as the Border Gateway Protocol (BGP).

During boot-up, an OSPF router initializes its routing-protocol-specific data structures and tables. When the lower-layer protocols with which it interfaces are functional, it sends the OSPF Hello protocol packets to find neighboring routers. A router sends Hello packets as keep-alive packets, informing other routers about its continuing functionality. Two routers are adjacent when their link state databases are synchronized.

Multi-access networks have more than two routers. On multi-access networks, the hello protocol chooses a designated router and a designated backup-router. The designated router generates LSAs for the entire multi-access network, and reduces network traffic and the size of the topological database. The designated router also determines the adjacency of routers and the synchronization of their topological databases. The data on a router's adjacencies or state changes are provided by periodic transmission of an LSA. Failed routers are detected, and topology is changed quickly by comparison of adjacencies to link states. Each router calculates a shortest path tree, with itself as a root, from the topological database generated from these LSAs. This shortest path tree creates a routing table.

BGP

Border Gateway Protocol (BGP) is an exterior gateway protocol (EGP) that determines the best path in networks, performs optimal routing between multiple autonomous systems or domains, and exchanges routing information with other BGP systems. The RFCs 1771 (BGP4), 1654 (first BGP4 specification), and 1105, 1163, 1267 (older version of BGP) describe BGP and BGP4.

Multiple-peer BGP routers in different autonomous systems, or administrative domains on the same physical network, support consistent internetwork topology using inter-autonomous system routing. Multiple-peer BGP routers within the same AS support consistent system topology using inter-autonomous system routing. BGP determines the router to serve as the connection point for specific external autonomous system routing services. Multiple-peer BGP routers transport traffic across an autonomous system that does not run BGP using pass-through autonomous-systems routing. In this case, if the traffic does not originate, or is destined for an autonomous system under consideration, the AS is used only to transport (pass-through) the traffic using another intra-autonomous system routing protocol.

BGP exchanges information about the list of autonomous system paths with other BGP systems. A connectivity mapping between autonomous systems is created, routing loops are pruned, and other autonomous systems-level policy decisions are taken. Each BGP router maintains a routing table of all feasible and optimal paths to other networks and incrementally updates the routing information received from other peer BGP routers.

The BGP routing metric describes the preference of the path, and is assigned to each link by the network administrator. The network administrator assigns this value to a link depending on path criteria such as:

- the number of autonomous systems through which the path passes
- the history of stability
- the line speed
- any delays
- cost per packet

PIM-SM

The AlliedWare Plus™ Protocol Independent Multicast–Sparse Mode (PIM-SM) module is a multicast routing protocol module that uses the underlying unicast Routing Information Base (RIB) to determine the best next-hop neighbor to reach the root of the multicast data distribution tree, the Rendezvous Point (RP), or the source. It builds unidirectional-shared trees per group, and optionally creates short test-path trees per source.

VRRP

Mission-critical applications running on fault-tolerant networking equipment, such as routers and switches, require redundancy and high availability. This section provides an architectural overview of Virtual Router Redundancy Protocol (VRRP) implementation in the AlliedWare Plus™ OS.

Typically, end hosts are connected to the enterprise network through a single router (first-hop router) that is in the same Local Area Network (LAN) segment. The most popular method of configuration is for the end hosts to statically configure this router as their default gateway. This minimizes configuration and processing overhead. The main problem with this configuration method is that it produces a single point of failure if the enterprise network's first-hop router fails.

VRRP attempts to solve this problem by introducing the concept of a virtual router, composed of two or more VRRP routers on the same subnet. The concept of a virtual IP address is also introduced, which is the address that end hosts configure as their default gateway. Only one of the routers (called the Master) forwards packets on behalf of this IP address. In the event that the Master fails, one of the other routers (Backups) assumes forwarding responsibility for it.

Chapter 29: Route Selection



Introduction.....	29.2
Types of Routes.....	29.2
Interface Routes	29.2
Static Routes	29.2
Dynamic Routes.....	29.3
RIB and FIB Routing Tables.....	29.4
Administrative Distance.....	29.4
Equal Cost Multipath Routing.....	29.7
How AlliedWare Plus Deletes Routes	29.7
How AlliedWare Plus Adds Routes.....	29.8

Introduction

This chapter describes the route selection process used by the AlliedWare Plus™ Operating System. Understanding the route selection process helps in analyzing and troubleshooting route-related problems.

The process of routing packets consists of selectively forwarding data packets from one network to another. Your device must determine which network to send each packet to, and over which interface to send the packet in order to reach the desired network. This information is contained in your device routes. For each packet, your device chooses the best route it has for that packet and uses that route to forward the packet. In addition, you can define filters to restrict the way packets are sent.

Types of Routes

Your device learns routes from static information entered as part of the configuration process and by listening to any configured routing protocols. The following types of routes are available on your device:

Interface Routes

Your device creates an interface route when you create the interface. This route tells your device to send packets over that interface when the packets are addressed to the interface's subnet.

Static Routes

You can manually enter routes, which are then called static routes. You can use static routes to:

- specify the default route (to 0.0.0.0). If your device does not have a route to the packet's destination, it sends it out the default route. The default route normally points to an external network such as the Internet.
- set up multiple networks or subnets. In this case you define multiple routes for a particular interface, usually a LAN port. This is a method of supporting multiple subnets on a single physical media.

To create a static route, use the command:

```
awplus(config)# ip route <subnet&mask> {<gateway-ip>|<interface>} [<1-255>]
```

Dynamic Routes

Your device learns dynamic routes from one or more routing protocols such as RIP, BGP, or OSPF. The routing protocol updates these routes as the network topology changes.

In all but the most simple networks, we recommend that you configure at least one dynamic routing protocol. Routing protocols enables your device to learn routes from other routers and switches on the network, and to respond automatically to changes in network topology.

Routing protocols use different metrics to calculate the best path for a destination. However, when two paths have an equal cost/metric and Equal Cost Multipath (ECMP) is enabled on a system, AlliedWare Plus™ may receive two paths from the same protocol.

■ Routing Information Protocol (RIP)

Routing Information Protocol (RIP) is a simple distance vector IPv4 routing protocol. It determines the number of hops between the destination and your device, where one hop is one link. Given a choice of routes, RIP uses the route that takes the lowest number of hops. If multiple routes have the same hop count, RIP chooses the first route it finds.

See [Chapter 31, RIP Configuration](#) for further information about RIP Configuration.

■ Routing Information Protocol next generation (RIPng)

Routing Information Protocol next generation (RIPng) is a simple distance vector IPv6 routing protocol. It determines the number of hops between the destination and your device, where one hop is one link. Given a choice of routes, RIPng uses the route that takes the lowest number of hops. If multiple routes have the same hop count, RIPng chooses the first route it finds.

RIPng (Routing Information Protocol next generation) is an extension of RIPv2 to support IPv6. RFC 2080 specifies RIPng. The differences between RIPv2 and RIPng are:

- « [RIPng does not support RIP updates authentication](#)
- « [RIPng does not allow the attachment of arbitrary tags to routes](#)
- « [RIPng requires the encoding of the next-hop for a set of routes](#)

See [Chapter 33, RIPng Configuration](#) for further information about RIPng Configuration.

■ Open Shortest Path First (OSPF)

The Open Shortest Path First (OSPF) protocol is documented in RFC 1247. It has a number of significant benefits over RIP, including:

- « [OSPF supports the concept of areas to allow networks to be administratively partitioned as they grow in size.](#)
- « [Load balancing, in which multiple routes exist to a destination, is also supported. OSPF distributes traffic over these links.](#)

See [Chapter 35, OSPF Configuration](#) for further information about OSPF Configuration.

■ Border Gateway Protocol (BGP)

The Border Gateway Protocol (BGP) allows routers in different routing domains to exchange routing information. This facilitates the forwarding of data across the borders of the routing domains. BGP-4 is based on distance vector (DV) protocol algorithms.

See [Chapter 37, BGP Configuration](#) for further information about BGP Configuration.

RIB and FIB Routing Tables

Your device maintains its routing information in routing tables that tell your device how to find a remote network or host. Each route is uniquely identified in a table by its IP address, network mask, next hop, interface, protocol, and policy. There are two routing tables populated by your device: the *Routing Information Base* (RIB) and the *Forwarding Information Base* (FIB).

Note  Routes in the FIB are used locally but are not advertised to neighbors if they are not also in the RIB.

Routing Information Base

The RIB records **all** the routes that your device has learnt. Your device uses the RIB to advertise routes to its neighbor devices and to populate the FIB. It adds routes to this table when:

- you add a static route using the `ip route` command
- one or more routing protocols, such as RIP or OSPF, exchanges routing information with other routers or hosts
- your device receives route information from a connected interface
- your device gathers route information from an ICMP redirect message or DHCP message

Forwarding Information Base

The RIB populates the *Forwarding Information Base* (FIB) with the best route to each destination. When your device receives an IP packet, and no filters are active that would exclude the packet, it uses the FIB to find the most specific route to the destination. If your device does not find a direct route to the destination, and no default route exists, it discards the packet and sends an ICMP message to that effect back to the source.

Adjusting table entries

To view the routes in the RIB, use the command:

```
awplus# show ip route database [bgp|connected|ospf|rip|static]
```

To view the routes in the FIB, use the command:

```
awplus# show ip route [bgp|connected|ospf|rip|static]<ip-addr>|<ip-addr/prefix-length>]
```

Administrative Distance

When multiple routes are available for the same prefix, the AlliedWare Plus™ Operating System adds the routes with the lowest *administrative distance* to the FIB. The administrative distance is a rank given to a route based on the protocol that the route was received from. The lower the administrative distance, the higher the route preference. For example, if the RIB has these routes

Route	Prefix	Protocol	Distance
1	192.168.0/16	eBGP	20
2	192.168.0/16	OSPF	110
3	192.168.1/24	OSPF	110

then the AlliedWare Plus™ Operating System adds routes 1 and 3 to the FIB. It does not add route 2, as this has a higher administrative distance than a route with the same prefix.

Note Administrative distance indicates a level of trustworthiness of a route where the lower the administrative distance the higher the integrity of a route.



The following table lists the default administrative distances of protocols.

Protocols	Distance	Preference
Connected Routes directly connected to an interface.	-	1 (highest)
Static Routes added using the ip route command or learnt through DHCP options on interfaces using DHCP to obtain an IP address.	1	2
eBGP Routes learnt from BGP that are external to your network.	20	3
OSPF Routes learnt from OSPF.	110	4
RIP Routes learnt from RIP.	120	5
iBGP Routes learnt from BGP that are internal to your network.	200	6 (lowest)
Unknown No traffic will be passed to neighbors via this route.	255	(route is not advertised to neighbors)

You can change the administrative distances for static routes and protocol derived routes. Use the following commands:

- for static routes, specify the distance when adding the route. Use the command:

```
awplus(config)# ip route <subnet&mask> {<gateway-ip>|<interface>} [<1-255>]
```

- for eBGP and iBGP routes, enter the Router Configuration mode, and use the command:

```
awplus(config-router)# distance bgp <ebgp> <ibgp> <local>
```

to enter a separate administrative distance value for each BGP route type. To set the administrative distance for a specific BGP route, use the command:

```
awplus(config-router)# distance <1-255> <ip-address/m> [<listname>]
```

- for OSPF routes, enter the Router Configuration mode, and use the command:

```
awplus(config-router)# distance ospf {external <1-255>|inter-area <1-255>|intra-area <1-255>}
```

to enter a separate administrative distance value for each OSPF route type. To set the same value for all OSPF route types, use the command:

```
awplus(config-router)# distance <1-255>
```

- for RIP routes, enter the Router Configuration mode, and use the command:

```
awplus(config-router)# distance <1-255> {<ip-addr/prefix-length> [<access-list>]}
```

This sets the administrative distance for all RIP routes.

You cannot set an administrative distance for connected routes.

Note  AlliedWare Plus™ does not populate routes with an administrative distance of 255 in the FIB (Forwarding Information Base). But AlliedWare Plus™ does populate routes with an administrative distance of 255 in the RIB (Routing Information Base). See the below examples showing the behavior of a static route with an administrative distance of 255, which is only added to the RIB, as seen from the below show output.

Output Figure 29-1: Static route with an administrative distance of 255 that is added to the RIB

```
awplus(config)#ip route 100.0.0.0/24 192.168.1.100 255
awplus(config)#end
awplus#show ip route database

Codes: C - connected, S - static, R - RIP, B - BGP
       O - OSPF, IA - OSPF inter area
       N1 - OSPF NSSA external type 1, N2 - OSPF NSSA external type 2
       E1 - OSPF external type 1, E2 - OSPF external type 2
       > - selected route, * - FIB route, p - stale info

S      100.0.0.0/24 [255/0] via 192.168.1.100, vlan1
C      *> 192.168.1.0/24 is directly connected, vlan1
```

Output Figure 29-2: Static route with an administrative distance of 255 that is not added to the FIB

```
awplus(config)#ip route 100.0.0.0/24 192.168.1.100 255
awplus(config)#end
awplus#show ip route

Codes: C - connected, S - static, R - RIP, B - BGP
       O - OSPF, IA - OSPF inter area
       N1 - OSPF NSSA external type 1, N2 - OSPF NSSA external type 2
       E1 - OSPF external type 1, E2 - OSPF external type 2
       * - candidate default

C      192.168.1.0/24 is directly connected, vlan1
```

Equal Cost Multipath Routing

When multiple routes are available for the same prefix within the FIB, then your device uses Equal Cost Multipath Routing (ECMP) to determine how to forward packets.

ECMP allows the AlliedWare Plus™ Operating System to distribute traffic over multiple equal-cost routes to a destination. The software determines that two or more routes are equal cost if they have the same destination IP address and mask. When the software learns such multiple routes, it puts them in an ECMP route group. When it sends traffic to that destination, it distributes the traffic across all routes in the group.

The AlliedWare Plus™ Operating System distributes traffic over the routes one flow at a time, so all packets in a session take the same route. Each equal-cost route group can contain up to eight individual routes. ECMP is only used to select between routes already in the FIB.

By default, each equal-cost route group can contain four routes. You can change this setting by using the command:

```
awplus(config)#maximum-paths <1-8>
```

The maximum path setting determines how many routes with the same prefix value and the same administrative distance that the FIB can contain. Once an equal-cost route group has the maximum number of routes, then the RIB cannot add any further routes to the route group. The device only adds to the group if a route is deleted from the FIB.

To disable ECMP, set the maximum paths value to one.

How AlliedWare Plus Deletes Routes

When the AlliedWare Plus™ Operating System receives a route delete request from a routing protocol, it first deletes the specified route from its RIB. Then it checks if the specified route is in the FIB. If the route is in the FIB, it deletes it from the FIB and checks if another route is available in its database for the same prefix. If there is another route in the database, the software installs this route in the FIB. When multiple such routes exist, the software uses the route selection mechanism to choose the best route before adding it to the FIB.

How AlliedWare Plus Adds Routes

The following flow chart shows how the software adds a route to the FIB.

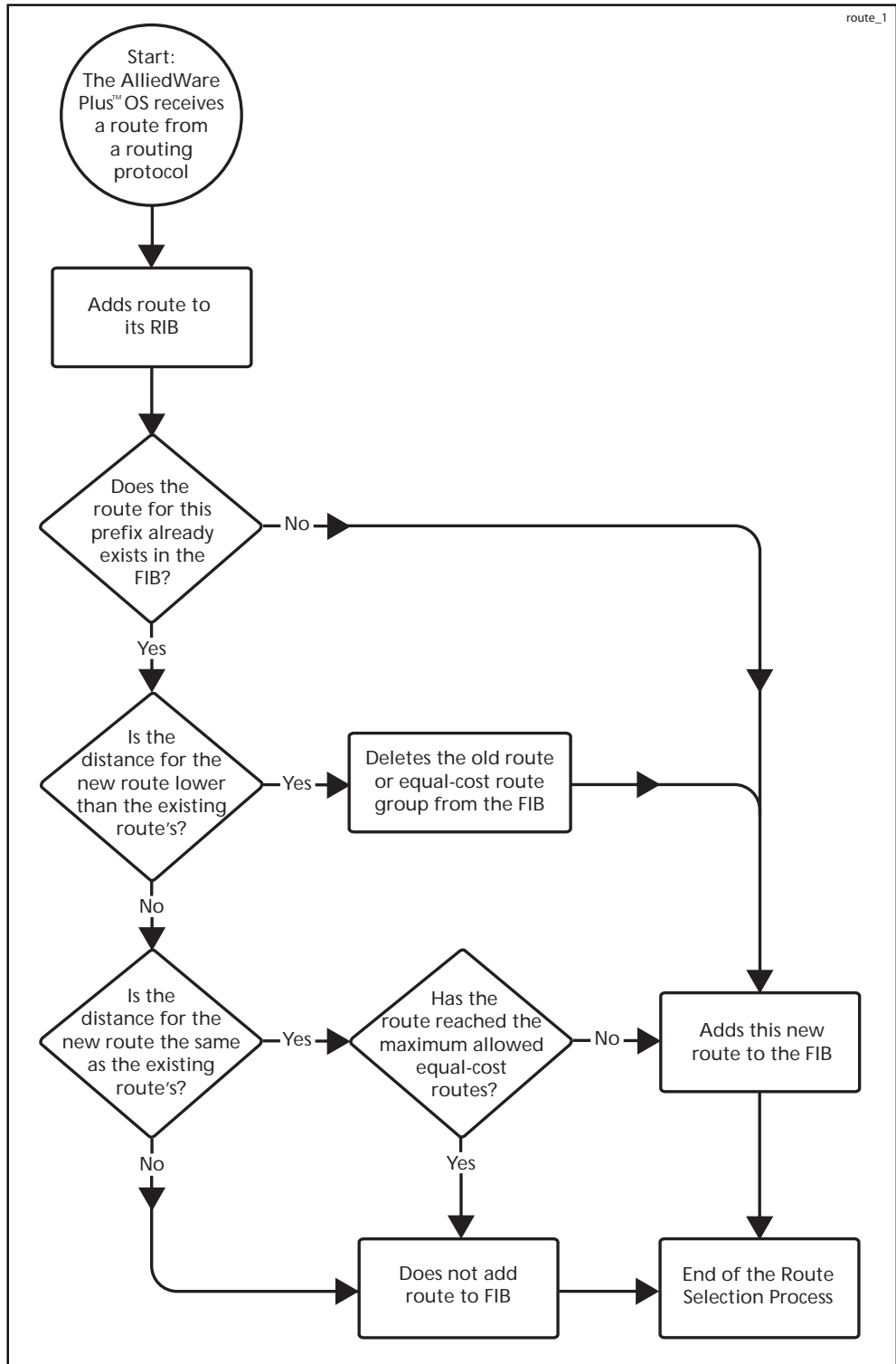

Chapter 30: Routing Commands



Command List	30.2
ip route	30.2
maximum-paths	30.3
show ip route	30.4
show ip route database	30.6
show ip route summary	30.7

Command List

This chapter provides an alphabetical reference of commands routing commands that are common across the routing IP protocols. For more information see [Chapter 28, Routing Protocol Overview](#) and [Chapter 29, Route Selection](#).

ip route

This command adds a static route to the Routing Information Base (RIB). If this route is the best route for the destination, then your device adds it to the Forwarding Information Base (FIB). Your device uses the FIB to advertise routes to neighbors and forward packets.

The **no** variant of this command removes the static route from the RIB and FIB.

Syntax `ip route <subnet&mask> {<gateway-ip>|<interface>} [<1-255>]`
`no ip route <subnet&mask> {<gateway-ip>|<interface>} [<1-255>]`

Parameter	Description
<subnet&mask>	The IPv4 address of the destination prefix with either a prefix length or a separate mask specified in one of the following formats: The IPv4 subnet address in dotted decimal notation followed by the subnet mask in dotted decimal notation. The IPv4 subnet address in dotted decimal notation followed by a forward slash, then the prefix length.
<gateway-ip>	The IPv4 address of the gateway device.
<interface>	The interface that connects your device to the network. Enter the name of the VLAN or its VID.
<1-255>	The administrative distance for this route. For more information about setting administrative distances, see "Administrative Distance" on page 29.4 .

Mode Global Configuration

Examples To add the destination 192.168.3.0 with the mask 255.255.255.0 as a static route available through the device at "10.10.0.2" with an administrative distance of 128, use the command:

```
awplus# configure terminal
awplus(config)# ip route 192.168.3.0 255.255.255.0 10.10.0.2 128
```

To add the destination 10.0.0.0 with a prefix length of 8 as a static route available through vlan4 with an administrative distance of 32, use the command:

```
awplus# configure terminal
awplus(config)# ip route 10.0.0.0/8 vlan4 32
```

Related Commands [show ip route](#)

maximum-paths

This command enables ECMP on your device, and sets the maximum number of paths that each route has in the Forwarding Information Base (FIB). ECMP is enabled by default.

The **no** variant of this command sets the maximum paths to the default of 4.

Syntax `maximum-paths <1-8>`

`no maximum-paths`

Parameter	Description
<code><1-8></code>	The maximum number of paths that a route can have in the FIB.

Default By default the maximum number of paths is 4.

Mode Global Configuration

Examples To set the maximum number of paths for each route in the FIB to 5, use the command:

```
awplus# configure terminal
awplus(config)# maximum-paths 5
```

To set the maximum paths for a route to the default of 4, use the command:

```
awplus# configure terminal
awplus(config)# no maximum-paths
```

show ip route

Use the **show ip route** command to display the current state of the routing table.

This command displays the routes in the FIB (Forwarding Information Base). The FIB contains the best routes to a destination, and your device uses these routes when forwarding traffic. You can use this command to view a subset of the FIB based on protocol or network.

To modify the lines displayed, use the | (output modifier token); to save the output to a file, use the > output redirection token.

Syntax `show ip route [bgp|connected|ospf|rip|static|<ip-addr>|<ip-addr/prefix-length>]`

Parameter	Description
<code>bgp</code>	Displays only the routes learned from BGP.
<code>connected</code>	Displays only the routes learned from connected interfaces.
<code>ospf</code>	Displays only the routes learned from OSPF.
<code>rip</code>	Displays only the routes learned from RIP.
<code>static</code>	Displays only the static routes you have configured.
<code><ip-addr></code>	Displays the routes for the specified address. Enter an IPv4 address.
<code><ip-addr/prefix-length></code>	Displays the routes for the specified network. Enter an IPv4 address and prefix length.

Mode User Exec and Privileged Exec

Example To display the OSPF routes in the FIB, use the command:

```
awplus# show ip route ospf
```

Output Each entry in this table has a code preceding it, indicating the source of the routing entry. For example, O indicates OSPF as the origin of the route. The first few lines of the output list the possible codes that may be seen with the route entries.

Typically, route entries are composed of the following elements:

- code
- a second label indicating the sub-type of the route
- network or host ip address
- administrative distance and metric
- nexthop ip address
- outgoing interface name
- time since route entry was added

Figure 30-1: Example output from the **show ip route** command

```

Codes: C - connected, S - static, R - RIP, B - BGP
       O - OSPF, IA - OSPF inter area
       N1 - OSPF NSSA external type 1, N2 - OSPF NSSA external type 2
       E1 - OSPF external type 1, E2 - OSPF external type 2
       * - candidate default

O      10.10.37.0/24 [110/11] via 10.10.31.16, vlan2, 00:20:54
C      3.3.3.0/24 is directly connected, vlan1
C      10.10.31.0/24 is directly connected, vlan2
C      10.70.0.0/24 is directly connected, vlan4
O E2   14.5.1.0/24 [110/20] via 10.10.31.16, vlan2, 00:18:56
C      33.33.33.33/32 is directly connected, lo
  
```

To avoid repetition, only selected route entries comprised of different elements are described here:

OSPF Route O 10.10.37.0/24 [110/11] via 10.10.31.16, vlan2, 00:20:54
 This route entry denotes:

- This route in the network 10.10.37.0/24 was added by OSPF.
- This route has an administrative distance of 110 and metric/cost of 11.
- This route is reachable via nexthop 10.10.31.16.
- The outgoing local interface for this route is `vlan2`.
- This route was added 20 minutes and 54 seconds ago.

Connected Route C 10.10.31.0/24 is directly connected, vlan2

This route entry denotes:

- Route entries for network 10.10.31.0/24 are derived from the IP address of local interface `vlan2`.
- These routes are marked as Connected routes (C) and always preferred over routes for the same network learned from other routing protocols.

OSPF External Route O E2 14.5.1.0/24 [110/20] via 10.10.31.16, vlan2, 00:18:56

This route entry denotes:

- This route is the same as the other OSPF route explained above; the main difference is that it is a Type 2 External OSPF route.

Related Commands `maximum-paths`
`show ip route database`

show ip route database

This command displays the routing entries in the RIB (Routing Information Base). When multiple entries are available for the same prefix, RIB uses the routes' administrative distances to choose the best route. All best routes are entered into the FIB (Forwarding Information Base). To view the routes in the FIB, use the [show ip route](#) command.

To modify the lines displayed, use the | (output modifier token); to save the output to a file, use the > output redirection token.

Syntax `show ip route database [bgp|connected|ospf|rip|static]`

Parameter	Description
bgp	Displays only the routes learned from BGP.
connected	Displays only the routes learned from connected interfaces.
ospf	Displays only the routes learned from OSPF.
rip	Displays only the routes learned from RIP.
static	Displays only the static routes you have configured.

Mode User Exec and Privileged Exec

Example To display the static routes in the RIB, use the command:

```
awplus# show ip route database static
```

Output Figure 30-2: Example output from the [show ip route database](#) command

```
Codes: C - connected, S - static, R - RIP, B - BGP
O - OSPF, IA - OSPF inter area
N1 - OSPF NSSA external type 1, N2 - OSPF NSSA external type 2
E1 - OSPF external type 1, E2 - OSPF external type 2
> - selected route, * - FIB route, p - stale info

O   *> 9.9.9.9/32 [110/31] via 10.10.31.16, vlan2, 00:19:21
O   10.10.31.0/24 [110/1] is directly connected, vlan2, 00:28:20
C   *> 10.10.31.0/24 is directly connected, vlan2
S   *> 10.10.34.0/24 [1/0] via 10.10.31.16, vlan2
O   10.10.34.0/24 [110/31] via 10.10.31.16, vlan2, 00:21:19
O   *> 10.10.37.0/24 [110/11] via 10.10.31.16, vlan2, 00:21:19
C   *> 10.30.0.0/24 is directly connected, vlan6
S   *> 11.22.11.0/24 [1/0] via 10.10.31.16, vlan2
O E2 *> 14.5.1.0/24 [110/20] via 10.10.31.16, vlan2, 00:19:21
O   16.16.16.16/32 [110/11] via 10.10.31.16, vlan2, 00:21:19
S   *> 16.16.16.16/32 [1/0] via 10.10.31.16, vlan2
O   *> 17.17.17.17/32 [110/31] via 10.10.31.16, vlan2, 00:21:19
C   *> 45.45.45.45/32 is directly connected, lo
O   *> 55.55.55.55/32 [110/21] via 10.10.31.16, vlan2, 00:21:19
C   *> 127.0.0.0/8 is directly connected, lo
```

The routes added to the FIB are marked with a *. When multiple routes are available for the same prefix, the best route is indicated with the > symbol. All unselected routes have neither the * nor the > symbol.

```
S    *> 10.10.34.0/24 [1/0] via 10.10.31.16, vlan2
O      10.10.34.0/24 [110/31] via 10.10.31.16, vlan2, 00:21:19
```

These route entries denote:

- The same prefix was learned from OSPF and from static route configuration.
- Since this static route has a lower administrative distance than the OSPF route (110), the static route (1) is selected and installed in the FIB.

If the static route becomes unavailable, then the device automatically selects the OSPF route and installs it in the FIB.

Related Commands [maximum-paths](#)
[show ip route](#)

show ip route summary

This command displays a summary of the current RIB (Routing Information Base) entries.

To modify the lines displayed, use the | (output modifier token); to save the output to a file, use the > output redirection token.

Syntax `show ip route summary`

Mode User Exec and Privileged Exec

Example To display a summary of the current RIB entries, use the command:

```
awplus# show ip route summary
```

Output Figure 30-3: Example output from the `show ip route summary` command

```
IP routing table name is Default-IP-Routing-Table(0)
IP routing table maximum-paths is 4
Route Source      Networks
connected         5
ospf              2
Total            8
FIB              2
```

Related Commands [show ip route](#)
[show ip route database](#)

Chapter 31: RIP Configuration



Introduction.....	31.2
Enabling RIP.....	31.2
Specifying the RIP Version.....	31.4
RIPv2 Authentication (Single Key).....	31.6
RIPv2 Text Authentication (Multiple Keys).....	31.8
RIPv2 md5 authentication (multiple keys).....	31.12

Introduction

This chapter contains basic RIP configuration examples. To see details on the RIP commands used in these examples, or to see the outputs of the Validation commands, refer to the [Chapter 32, RIP Commands](#).

Enabling RIP

This example shows the minimum configuration required for enabling two devices to exchange routing information using RIP. The routing devices in this example are Allied Telesis managed Layer 3 Switches. **Switch 1** and **Switch 2** are two neighbors connecting to network 10.10.11.0/24. Switch 1 and Switch 2 are also connected to networks 10.10.10.0/24 and 10.10.12.0/24 respectively. This example assumes that the devices have already been configured with IP interfaces in those subnets.

To enable RIP, first define the RIP routing process and then associate a network with the routing process.

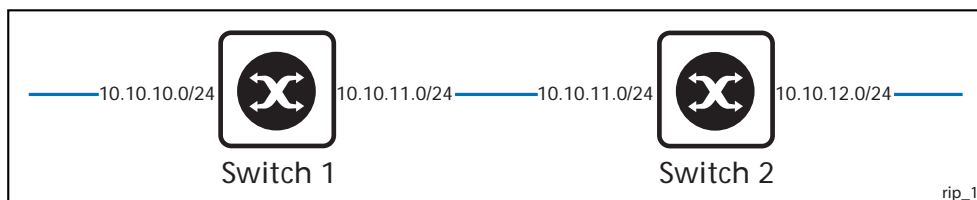

Switch 1

```

awplus#
configure terminal  Enter the Global Configuration mode.
-----
awplus(config)#
router rip          Define a RIP routing process and enter the Router
                   Configuration mode.
-----
awplus(config-router)#
network 10.10.10.0/24 Associate network 10.10.10.0/24 with the RIP process..
-----
awplus#
network 10.10.11.0/24 Associate network 10.10.11.0/24 with the RIP process.

```

Switch 2

```
awplus#  
configure terminal Enter the Global Configuration mode.  
awplus(config)#  
router rip Define a RIP routing process and enter the Router  
Configuration mode.  
awplus(config-router)#  
network 10.10.11.0/24 Associate networks with the RIP process  
awplus(config-router)#  
network 10.10.12.0/24 Associate networks with the RIP process
```

Names of Commands Used

router rip
network (RIP)

Validation Commands

show ip rip
show running-config
show ip protocols rip
show ip rip interface
show ip route

Specifying the RIP Version

Configure a router to receive and send specific versions of RIP packets on a VLAN interface. The routing devices in this example are Allied Telesis managed Layer 3 Switches. In this example, Switch 2 is configured to receive and send RIP version 1 and version 2 information on both `vlan2` and `vlan3` interfaces.

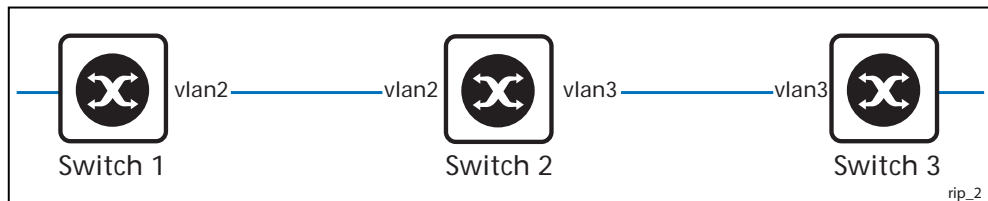

Switch 2

```

awplus#
  configure terminal  Enter the Global Configuration mode.
awplus(config)#
  router rip        Enable the RIP routing process.
awplus(config-router)#
  exit             Return to the Global Configuration mode
awplus(config)#
  interface vlan2  Specify vlan2 as an interface you want to configure.
awplus(config-if)#
  ip rip send version 1 2  Allow sending RIP version 1 and version 2 packets
                        out of this interface.
awplus(config-if)#
  ip rip receive version 1 2  Allow receiving of RIP version 1 and version 2
                        packets from the vlan2 interface.
awplus(config-if)#
  exit            Exit the Interface mode and return to Global
                Configuration mode to configure the next
                interface.
awplus(config)#
  interface vlan3  Specify interface vlan3 as the interface you want to
                configure.
awplus(config-if)#
  ip rip send version 1 2  Allow sending RIP version 1 and version 2 packets
                        out of this interface.
awplus(config-if)#
  ip rip receive version 1 2  Allow receiving of RIP version 1 and version 2
                        packets from the vlan3 interface.

```

Names of Commands Used

ip rip send version
ip rip receive version

Validation Commands

show ip rip
show running-config
show ip protocols rip
show ip rip interface
show ip route

RIPv2 Authentication (Single Key)

AlliedWare Plus™ RIP implementation provides the choice of configuring authentication for a single key or for multiple keys. This example illustrates authentication of the routing information exchange process for RIP using a single key. The routing devices in this example are Allied Telesis managed Layer 3 Switches. Switch 1 and Switch 2 are running RIP and exchange routing updates. To configure single key authentication on Switch 1, specify an interface and then define a key or password for that interface. Next, specify an authentication mode. Any receiving RIP packet on this specified interface should have the same string as password. For an exchange of updates between Switch 1 and Switch 2, define the same password and authentication mode on Switch 2.

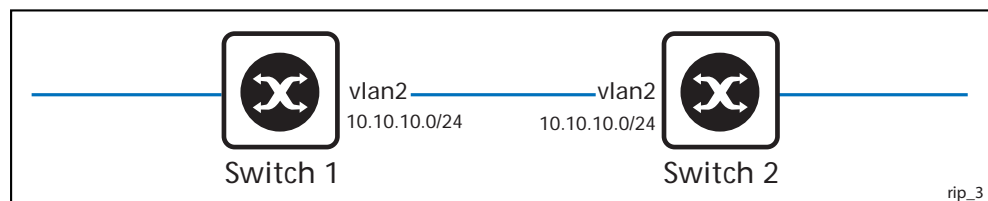

Switch 1

```

awplus#
configure terminal Enter the Configure mode.
-----
awplus(config)#
router rip Define a RIP routing process and enter the
Router Configuration mode.
-----
awplus(config-router)#
network 10.10.10.0/24 Associate network 10.10.10.0/24 with the
RIP process.
-----
awplus(config-router)#
redistribute connected Enable redistributing from connected routes.
-----
awplus(config-router)#
exit Exit the Router Configuration mode and
return to the Configure mode.
-----
awplus(config)#
interface vlan2 Specify the VLAN interface (vlan2) for
authentication.
-----
awplus(config-if)#
ip rip authentication string Specify the authentication string (Secret) for
Secret this interface.
-----
awplus(config-if)#
ip rip authentication mode md5 Specify the authentication mode to be MD5.

```

Switch 2

awplus#	
<code>configure terminal</code>	Enter the Global Configuration mode.
awplus(config)#	
<code>router rip</code>	Define a RIP routing process and enter the Router Configuration mode.
awplus(config-router)#	
<code>network 10.10.10.0/24</code>	Associate network 10.10.10.0/24 with the RIP process.
awplus(config-router)#	
<code>redistribute connected</code>	Enable redistributing from connected routes.
awplus(config-router)#	
<code>exit</code>	Exit the Router Configuration mode and return to the Global Configuration mode.
awplus(config)#	
<code>interface vlan2</code>	Specify the VLAN interface (vlan2) for authentication.
awplus(config-if)#	
<code>ip rip authentication string Secret</code>	Specify the authentication string (Secret) on this interface.
awplus(config-if)#	
<code>ip rip authentication mode md5</code>	Specify the authentication mode to be MD5.

Names of Commands Used

[ip rip authentication string](#)
[ip rip authentication mode](#)
[redistribute \(RIP\)](#)
[network \(RIP\)](#)

Validation Commands

[show ip rip](#)
[show running-config](#)
[show ip protocols rip](#)
[show ip rip interface](#)
[show ip route](#)

RIPv2 Text Authentication (Multiple Keys)

This example illustrates text authentication of the routing information exchange process for RIP using multiple keys. The routing devices in this example are Allied Telesis managed Layer 3 Switches. Switch 1 and Switch 2 are running RIP and exchanging routing updates. To configure authentication on Switch 1, define a key chain, specify keys in the key chain and then define the authentication string or passwords to be used by the keys. Set the time period during which it is valid to receive or send the authentication key by specifying the accept and send lifetimes. After defining the key string, specify the key chain (or the set of keys) that will be used for authentication on each interface and also the authentication mode to be used.

Switch 1 accepts all packets that contain any key string that matches one of the key strings included in the specified key chain (within the accept lifetime) on that interface. The key ID is not considered for matching. For additional security, the accept lifetime and send lifetime are configured such that every fifth day the key ID and key string changes. To maintain continuity, the accept lifetimes should be configured to overlap. This will accommodate different time-setup on machines. However, the send lifetime does not need to overlap and we recommend not configuring overlapping send lifetimes.

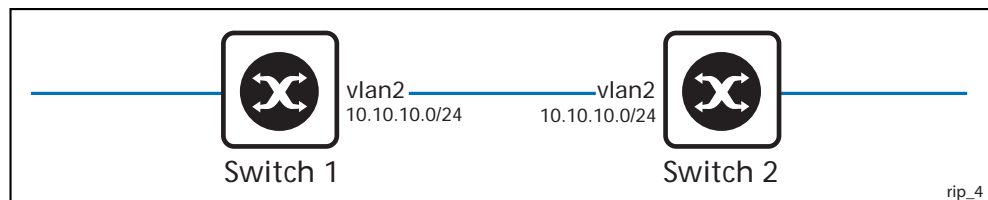

Switch 1

<code>awplus#</code>	
<code>configure terminal</code>	Enter the Global Configuration mode.
<code>awplus(config)#</code>	
<code>router rip</code>	Define a RIP routing process and enter the Router Configuration mode.
<code>awplus(config-router)#</code>	
<code>network 10.10.10.0/24</code>	Associate network 10.10.10.0/24 with the RIP process.
<code>awplus(config-router)#</code>	
<code>redistribute connected</code>	Enable redistributing of connected routes.
<code>awplus(config-router)#</code>	
<code>exit</code>	Exit the Router Configuration mode and return to the Global Configuration mode.
<code>awplus(config)#</code>	
<code>key chain SUN</code>	Enter the key chain management mode to add keys to the key chain SUN.
<code>awplus(config-keychain)#</code>	
<code>key 10</code>	Add authentication key ID (10) to the key chain SUN.
<code>awplus(config-keychain-key)#</code>	
<code>key-string Secret</code>	Specify a password (Secret) to be used by the specified key.

Switch 1 (cont.)

awplus(config-keychain-key)#	
accept-lifetime 12:00:00 Mar 2 2007	Specify the time period during which authentication key string <code>Secret</code> can be received. In this case, key string <code>Secret</code> can be received from noon of March 2 to 2 pm March 7, 2007.
14:00:00 Mar 7 2007	
<hr/>	
awplus(config-keychain-key)#	
send-lifetime 12:00:00 Mar 2 2007	Specify the time period during which authentication key string <code>Secret</code> can be send. In this case, key string <code>Secret</code> can be received from noon of March 2 to noon of March 7, 2007.
12:00:00 Mar 7 2007	
<hr/>	
awplus(config-keychain-key)#	
exit	Exit the keychain-key mode and return to keychain mode.
<hr/>	
awplus(config-keychain)#	
key 20	Add another authentication key (20) to the key chain <code>SUN</code> .
<hr/>	
awplus(config-keychain-key)#	
key-string Earth	Specify a password (<code>Earth</code>) to be used by the specified key.
<hr/>	
awplus(config-keychain-key)#	
accept-lifetime 12:00:00 Mar 7 2007	Specify the time period during which authentication key string <code>Earth</code> can be received. In this case, key string <code>Earth</code> can be received from noon of March 7 to 2 pm March 12, 2007.
14:00:00 Mar 12 2007	
<hr/>	
awplus(config-keychain-key)#	
send-lifetime 12:00:00 Mar 7 2007	Specify the time period during which authentication key string <code>Earth</code> can be sent. In this case, key string <code>Secret</code> can be received from noon of March 7 to noon of March 12, 2007.
12:00:00 Mar 12 2007	
<hr/>	
awplus(config-keychain-key)#	
end	Enter Privileged Exec mode.
<hr/>	
awplus#	
configure terminal	Enter the Global Configuration mode.
<hr/>	
awplus(config)#	
interface vlan2	Specify VLAN interface (vlan2) as the interface you want to configure on Switch 1.
<hr/>	
awplus(config-if)#	
ip rip authentication key-chain SUN	Enable RIPv2 authentication on the <code>vlan2</code> interface and specify the key chain <code>SUN</code> to be used for authentication.
<hr/>	
awplus(config-if)#	
ip rip authentication mode text	Specify text authentication mode to be used for RIP packets. This step is optional, as text is the default mode.

Switch 2

<code>awplus#</code>	
<code>configure terminal</code>	Enter the Global Configuration mode.
<code>awplus(config)#</code>	
<code>router rip</code>	Define a RIP routing process and enter the Router Configuration mode.
<code>awplus(config-router)#</code>	
<code>network 10.10.10.0/24</code>	Associate network 10.10.10.0/24 with the RIP process.
<code>awplus(config-router)#</code>	
<code>redistribute connected</code>	Enable redistributing from connected routes.
<code>awplus(config-router)#</code>	
<code>exit</code>	Exit the Router Configuration mode and return to the Global Configuration mode.
<code>awplus(config)#</code>	
<code>key chain MOON</code>	Enter the key chain management mode to add keys to the key chain MOON.
<code>awplus(config-keychain)#</code>	
<code>key 30</code>	Add authentication key ID (30) to the key chain MOON.
<code>awplus(config-keychain-key)#</code>	
<code>key-string Secret</code>	Specify a password (Secret) to be used by the specified key.
<code>awplus(config-keychain-key)#</code>	
<code>accept-lifetime 12:00:00 Mar 2 2007</code> <code>14:00:00 Mar 7 2007</code>	Specify the time period during which authentication key string Secret can be received. In this case, key string Secret can be received from noon of March 2 to 2 pm March 7, 2007.
<code>awplus(config-keychain-key)#</code>	
<code>send-lifetime 12:00:00 Mar 2 2007</code> <code>12:00:00 Mar 7 2007</code>	Specify the time period during which authentication key string Secret can be send. In this case, key string Secret can be received from noon of March 2 to noon of March 7, 2007.
<code>awplus(config-keychain)#</code>	
<code>key 40</code>	Add another authentication key (40) to the key chain MOON.
<code>awplus(config-keychain-key)#</code>	
<code>key-string Earth</code>	Specify a password (Earth) to be used by the specified key.
<code>awplus(config-keychain-key)#</code>	
<code>accept-lifetime 12:00:00 Mar 7 2007</code> <code>14:00:00 Mar 12 2007</code>	Specify the time period during which authentication key string Earth can be received. In this case, key string Earth can be received from noon of March 7 to 2 pm March 12, 2007.

Switch 2 (cont.)

<code>awplus(config-keychain-key)#</code>	
<code>send-lifetime 12:00:00 Mar 7 2007</code>	Specify the time period during which authentication key string <code>Earth</code> can be sent. In this case, key string <code>Secret</code> can be received from noon of March 7 to noon of March 12, 2007.
<code>12:00:00 Mar 12 2007</code>	
<hr/>	
<code>awplus(config-keychain-key)#</code>	
<code>end</code>	Enter Privileged Exec mode.
<hr/>	
<code>awplus#</code>	
<code>configure terminal</code>	Enter the Global Configuration mode.
<hr/>	
<code>awplus(config)#</code>	
<code>interface vlan2</code>	Specify the VLAN interface that you want to configure on Switch 2.
<hr/>	
<code>awplus(config-if)#</code>	
<code>ip rip authentication key-chain MOON</code>	Enable RIPv2 authentication on the <code>vlan2</code> interface, and specify the key chain <code>MOON</code> to be used for authentication.
<hr/>	
<code>awplus(config-if)#</code>	
<code>ip rip authentication mode text</code>	Specify authentication mode to be used for RIP packets. This step is optional, as <code>text</code> is the default mode.

Names of Commands Used

[key chain, key-string](#)
[accept-lifetime](#)
[send-lifetime](#)
[ip rip authentication key-chain](#)
[ip rip authentication mode](#)

Validation Commands

[show ip rip](#)
[show running-config](#)
[show ip protocols rip](#)
[show ip rip interface, show ip route](#)

RIPv2 md5 authentication (multiple keys)

This example illustrates the md5 authentication of the routing information exchange process for RIP using multiple keys. The routing devices in this example are Allied Telesis managed Layer 3 Switches. Switch 1 and Switch 2 are running RIP and exchange routing updates. To configure authentication on Switch 1, define a key chain, specify keys in the key chain and then define the authentication string or passwords to be used by the keys. Then set the time period during which it is valid to receive or send the authentication key by specifying the accept and send lifetimes. After defining the key string, specify the key chain (or the set of keys) that will be used for authentication on the interface and the authentication mode to be used. Configure Switch 2 and Switch 3 to have the same key ID and key string as Switch 1 for the time that updates need to be exchanged.

In md5 authentication, both the key ID and key string are matched for authentication. Switch 1 will receive only packets that match both the key ID and the key string in the specified key chain (within the accept lifetime) on that interface. In the following example, Switch 2 has the same key ID and key string as Switch 1. For additional security, the accept lifetime and send lifetime are configured such that every fifth day the key ID and key string changes. To maintain continuity, the accept lifetimes should be configured to overlap; however, the send lifetime should not be overlapping.

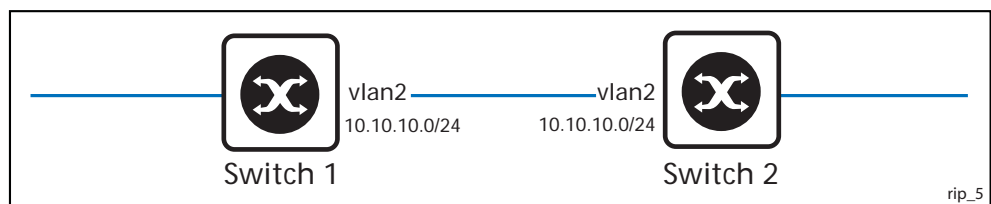

Switch 1

```

awplus#
configure terminal  Enter the Global Configuration mode.
awplus(config)#
router rip          Define a RIP routing process and enter the Router Configuration
                   mode.
awplus(config-router)#
network 10.10.10.0/24 Associate network 10.10.10.0/24 with the RIP process.
awplus(config-router)#
redistribute connected Enable redistributing from connected routes.
awplus(config-router)#
exit               Exit the Router Configuration mode and return to the Global
                   Configuration mode.
awplus(config)#
key chain SUN      Enter the key chain management mode to add keys to the key
                   chain SUN.
awplus(config-keychain)#
key 1              Add authentication key ID (1) to the key chain SUN.

```

Switch 1 (cont.)

awplus(config-keychain-key)# key-string Secret	Specify a password (Secret) to be used by the specified key.
---	---

awplus(config-keychain-key)# accept-lifetime 12:00:00 Mar 2 2007 14:00:00 Mar 7 2007	Specify the time period during which authentication key string Secret can be received. In this case, key string Secret can be received from noon of March 2 to 2 pm March 7, 2007.
--	--

awplus(config-keychain-key)# send-lifetime 12:00:00 Mar 2 2007 12:00:00 Mar 7 2007	Specify the time period during which authentication key string Secret can be send. In this case, key string Secret can be received from noon of March 2 to noon of March 7, 2007.
--	---

awplus(config-keychain-key)# exit	Exit the keychain-key mode and return to keychain mode.
--------------------------------------	---

awplus(config-keychain)# key 2	Add another authentication key (2) to the key chain SUN .
-----------------------------------	--

awplus(config-keychain-key)# key-string Earth	Specify a password (Earth) to be used by the specified key.
--	--

awplus(config-keychain-key)# accept-lifetime 12:00:00 Mar 7 2007 14:00:00 Mar 12 2007	Specify the time period during which authentication key string Earth can be received. In this case, key string Earth can be received from noon of March 7 to 2 pm March 12, 2007.
---	---

awplus(config-keychain-key)# send-lifetime 12:00:00 Mar 7 2007 12:00:00 Mar 12 2007	Specify the time period during which authentication key string Earth can be send. In this case, key string Secret can be received from noon of March 7 to noon of March 12, 2007.
---	---

awplus(config-keychain-key)# end	Enter Privileged Exec mode.
-------------------------------------	-----------------------------

awplus# configure terminal	Enter the Global Configuration mode.
-------------------------------	--------------------------------------

awplus(config)# interface vlan2	Specify interface vlan2 as the VLAN interface you want to configure on Switch 1.
------------------------------------	---

awplus(config-if)# ip rip authentication key-chain SUN	Enable RIPv2 authentication on the vlan2 interface and specify the key chain SUN to be used for authentication.
--	---

awplus(config-if)# ip rip authentication mode md5	Specify the md5 authentication mode to be used for RIP packets.
--	--

Switch 2

awplus#	
configure terminal	Enter the Global Configuration mode.
awplus(config)#	
router rip	Define a RIP routing process and enter the Router Configuration mode.
awplus(config-router)#	
network 10.10.10.0/24	Associate network 10.10.10.0/24 with the RIP process.
awplus(config-router)#	
redistribute connected	Enable redistributing from connected routes.
awplus(config-router)#	
exit	Exit the Router Configuration mode and return to the Global Configuration mode.
awplus(config)#	
key chain MOON	Enter the key chain management mode to add keys to the key chain MOON.
awplus(config-keychain)#	
key 1	Add authentication key ID (1) to the key chain MOON.
awplus(config-keychain-key)#	
key-string Secret	Specify a password (Secret) to be used by the specified key.
awplus(config-keychain-key)#	
accept-lifetime 12:00:00 Mar 2 2007 14:00:00 Mar 7 2007	Specify the time period during which authentication key string Secret can be received. In this case, key string Secret can be received from noon of March 2 to 2 pm March 7, 2007.
awplus(config-keychain-key)#	
send-lifetime 12:00:00 Mar 2 2007 12:00:00 Mar 7 2007	Specify the time period during which authentication key string Secret can be send. In this case, key string Secret can be received from noon of March 2 to noon of March 7, 2007.
awplus(config-keychain)#	
key 2	Add another authentication key (2) to the key chain MOON.
awplus(config-keychain-key)#	
key-string Earth	Specify a password (Earth) to be used by the specified key.
awplus(config-keychain-key)#	
accept-lifetime 12:00:00 Mar 7 2007 14:00:00 Mar 12 2007	Specify the time period during which authentication key string Earth can be received. In this case, key string Earth can be received from noon of March 7 to 2 pm March 12, 2007.
awplus(config-keychain-key)#	
send-lifetime 12:00:00 Mar 7 2007 12:00:00 Mar 12 2007	Specify the time period during which authentication key string Earth can be send. In this case, key string Secret can be received from noon of March 7 to noon of March 12, 2007.
awplus(config-keychain-key)#	
end	Enter Privileged Exec mode.

Switch 2 (cont.)

<code>awplus#</code>	
<code>configure terminal</code>	Enter the Global Configuration mode.
<code>awplus(config)#</code>	
<code>interface vlan2</code>	Specify vlan2 as the VLAN interface you want to configure on Switch 2.
<code>awplus(config-if)#</code>	
<code>ip rip authentication key-chain MOON</code>	Enable RIPv2 authentication on the <code>vlan2</code> interface and specify the key chain <code>MOON</code> to be used for authentication.
<code>awplus(config-if)#</code>	
<code>ip rip authentication mode md5</code>	Specify the md5 authentication mode to be used for RIP packets.

Names of Commands Used

key chain
 key-string
 accept-lifetime
 send-lifetime
 ip rip authentication key-chain
 ip rip authentication mode

Validation Commands

show ip rip
 show running-config
 show ip protocols rip
 show ip rip interface

Chapter 32: RIP Commands



Command List	32.2
accept-lifetime.....	32.2
cisco-metric-behavior (RIP).....	32.4
clear ip rip route.....	32.5
debug rip.....	32.6
default-information originate (RIP)	32.7
default-metric (RIP).....	32.8
distance (RIP)	32.9
distribute-list (RIP).....	32.10
ip rip authentication key-chain.....	32.11
ip rip authentication mode.....	32.14
ip rip authentication string.....	32.18
ip rip receive-packet.....	32.20
ip rip receive version.....	32.21
ip rip send-packet	32.22
ip rip send version.....	32.23
ip rip send version 1-compatible.....	32.24
ip rip split-horizon.....	32.25
key	32.26
key chain	32.27
key-string.....	32.28
maximum-prefix.....	32.29
neighbor (RIP).....	32.30
network (RIP).....	32.31
offset-list (RIP)	32.32
passive-interface (RIP)	32.33
recv-buffer-size (RIP)	32.34
redistribute (RIP)	32.35
restart rip graceful.....	32.36
rip restart grace-period.....	32.36
route (RIP)	32.37
router rip	32.38
send-lifetime.....	32.39
show debugging rip.....	32.40
show ip protocols rip.....	32.40
show ip rip	32.41
show ip rip database	32.41
show ip rip interface.....	32.42
timers (RIP).....	32.43
undebug rip	32.44
version.....	32.45

Command List

This chapter provides an alphabetical reference of commands used to configure RIP. For more information, see [Chapter 31, RIP Configuration](#).

accept-lifetime

Use this command to specify the time period during which the authentication key on a key chain is received as valid.

Use the **no** variant of this command to remove a specified time period for an authentication key on a key chain as set previously with the **accept-lifetime** command.

Syntax `accept-lifetime <start-date>{<end-date>|duration <seconds>|infinite}`
`no accept-lifetime`

Parameter	Description
<code><start-date></code>	Specifies the start period - time and date in the format DD MMM YYYY or MMM DD YYYY: <code><hh:mm:ss> {<day> <month> <year> <month> <day> <year>}</code>
<code><hh:mm:ss></code>	Time of the day when accept-lifetime starts, in hours, minutes and seconds
<code><day></code>	<1-31> Specifies the day of the month to start.
<code><month></code>	Specifies the month of the year to start (the first three letters of the month, for example, Jan).
<code><year></code>	<1993-2035> Specifies the year to start.
<code><end-date></code>	Specifies the end period - time and date in the format DD MMM YYYY or MMM DD YYYY: <code><hh:mm:ss> {<day> <month> <year> <month> <day> <year>}</code>
<code><hh:mm:ss></code>	Time of the day when lifetime expires, in hours, minutes and seconds.
<code><day></code>	<1-31> Specifies the day of the month to expire.
<code><month></code>	Specifies the month of the year to expire (the first three letters of the month, for example, Feb).
<code><year></code>	<1993-2035> Specifies the year to expire.
<code><seconds></code>	<1-2147483646> Duration of the key in seconds.
<code>infinite</code>	Never expires.

Mode Keychain-key Configuration

Examples The following examples show the setting of accept-lifetime for key1 on the key chain named mychain.

```
awplus# configure terminal
awplus(config)# key chain mychain
awplus(config-keychain)# key 1
awplus(config-keychain-key)# accept-lifetime 03:03:01 Dec 3
                             2007 04:04:02 Oct 6 2008
```

OR:

```
awplus# configure terminal
awplus(config)# key chain mychain
awplus(config-keychain)# key 1
awplus(config-keychain-key)# accept-lifetime 03:03:01 3 Dec
                             2007 04:04:02 6 Oct 2008
```

Related Commands [key](#)
[key-string](#)
[key chain](#)
[send-lifetime](#)

cisco-metric-behavior (RIP)

Use this command to enable or disable the RIP routing metric update to conform to Cisco's implementation. The Cisco implementation sets the metric of redistributed connected and static RIP routes to 0 by default. Note that AlliedWare Plus sets this metric to 1 by default when using the **default-metric (RIP)** command.

Use the **no** variant of this command to disable this feature.

Syntax `cisco-metric-behavior {enable|disable}`
`no cisco-metric-behavior`

Parameter	Description
<code>enable</code>	Enables updating the metric consistent with Cisco.
<code>disable</code>	Disables updating the metric consistent with Cisco.

Default By default, the Cisco metric-behavior is disabled. Note the difference between the metric applied with the **default-metric (RIP)** command, and the metric applied with this command.

Mode Router Configuration

Usage When a RIP device with **cisco metric-behavior** enabled sends an update, it adds the metric of the outgoing interface to the update, and the receiver of the update accepts the metric sent. Less routing control is given to the local router, because the local router adopts the sent metric.

When a RIP device with **cisco metric-behavior** disabled sends an update, this behavior is reversed so the receiving RIP device adds the interface metric on which the update arrived onto the metric contained in the update. More routing control is given to the local router, so the local router can change its interface metric setting to prefer routes from one interface over another. See the **default-metric (RIP)** command description for further information.

Examples To enable the routing metric update to behave as per the Cisco implementation, enter the command:

```
awplus# configure terminal
awplus(config)# router rip
awplus(config-router)# cisco-metric-behavior enable
```

To disable the routing metric update to behave as per the Cisco implementation, enter the command:

```
awplus# configure terminal
awplus(config)# router rip
awplus(config-router)# cisco-metric-behavior disable
```

To disable the routing metric update to behave as per the Cisco implementation, enter the command:

```
awplus# configure terminal
awplus(config)# router rip
awplus(config-router)# no cisco-metric-behavior
```

Validation Commands show running-config

Related Commands cisco-metric-behavior (RIPng)
default-metric (RIP)

clear ip rip route

Use this command to clear specific data from the RIP routing table.

Syntax clear ip rip route {<ip-dest-network/prefix-length>|static|connected|rip|ospf|bgp|all}

Parameter	Description
<ip-dest-network/prefix-length>	Removes entries which exactly match this destination address from RIP routing table. Enter the IP address and prefix length of the destination network.
static	Removes static entries from the RIP routing table.
connected	Removes entries for connected routes from the RIP routing table.
rip	Removes only RIP routes from the RIP routing table.
ospf	Removes only OSPF routes from the RIP routing table.
bgp	Removes only BGP routes from the RIP routing table.
all	Clears the entire RIP routing table.

Mode Privileged Exec

Usage Using this command with the `all` parameter, clears the RIP table of all the routes.

Examples

```
awplus# clear ip rip route 10.0.0.0/8
awplus# clear ip rip route ospf
```

debug rip

Use this command to specify the options for the displayed debugging information for RIP events and RIP packets.

Use the **no** variant of this command to disable the specified debug option.

Syntax `debug rip {events|nsm|<packet>|all}`
`no debug rip {events|nsm|<packet>|all}`

Parameter	Description
events	RIP events debug information is displayed.
nsm	RIP and NSM communication is displayed
<packet>	packet [recv send] [detail] Specifies RIP packets only
recv	Specifies that information for received packets be displayed.
send	Specifies that information for sent packets be displayed.
detail	Displays detailed information for the sent or received packet.
all	Displays all RIP debug information.

Default Disabled

Mode Privileged Exec and Global Configuration

Example The following example displays information about the RIP packets that are received and sent out from the device.

```
awplus# debug rip packet
```

Related Commands [undebug rip](#)

default-information originate (RIP)

Use this command to generate a default route into the Routing Information Protocol (RIP).

Use the **no** variant of this command to disable this feature.

Syntax default-information originate
no default-information originate

Default Disabled

Mode Router Configuration

Example

```
awplus# configure terminal
awplus(config)# router rip
awplus(config-router)# default-information originate
```

default-metric (RIP)

Use this command to specify the metrics to be assigned to redistributed routes.

Use the **no** variant of this command to reset the metric back to its default value (1).

Syntax

```
default-metric <metric>
no default-metric <metric>
no default-metric
```

Parameter	Diagnostic
<metric>	<1-16> Specifies the default metric.

Default By default, the metric value is set to 1, the default administrative distance for a static route.

Mode Router Configuration

Usage This command is used with the [redistribute \(RIP\)](#) command to make the routing protocol use the specified metric value for all redistributed routes. Default metric is useful in redistributing routes with incompatible metrics. Every protocol has different metrics and can not be compared directly. Default metric provides the standard to compare. All routes that are redistributed will use the default metric. See the [Administrative Distance](#) section in [Chapter 29, Route Selection](#) for further information about default route metrics for protocols.

When a RIP device receives an update, it adds the interface metric on which the update arrived onto the metric contained in the update. This gives more routing control to the local router to change its interface metric setting to prefer routes from one interface over another.

Note that the [cisco-metric-behavior \(RIP\)](#) command is an alternative to this command, and reverses this behavior by having the device that sends the update add the metric of the outgoing interface to the update, then the receiver adopts the metric that was sent from the sender. This gives less control to the local router to prefer routes from one interface over another. See the [cisco-metric-behavior \(RIP\)](#) command description for further information.

Example This example assigns the cost of 10 to the OSPF routes which are redistributed into RIP.

```
awplus# configure terminal
awplus(config)# router rip
awplus(config-router)# redistribute ospf
awplus(config-router)# default-metric 10
```

Related Commands [cisco-metric-behavior \(RIP\)](#)

distance (RIP)

This command sets the administrative distance for RIP routes. Your device uses this value to select between two or more routes to the same destination from two different routing protocols. The route with the smallest administrative distance value is added to the Forwarding Information Base (FIB). See [“Administrative Distance” on page 29.4](#) for more information.

The **no** variant of this command sets the administrative distance for the RIP route to the default of 120.

Syntax `distance <1-255> {<ip-addr/prefix-length> [<access-list>]}`
`no distance <1-255> {<ip-addr/prefix-length> [<access-list>]}`

Parameter	Description
<code><1-255></code>	The administrative distance value you are setting for this RIP route.
<code><ip-addr/prefix-length></code>	The network prefix that you are changing the administrative distance for. Enter an IPv4 address and prefix length.
<code><access-list></code>	Specifies the access-list name. This access list specifies which routes within the network <code><ip-address/m></code> this command applies to.

Mode Router Configuration

Examples To set the administrative distance to 8 for the RIP routes within the 10.0.0.0/8 network that match the access-list `mylist`, use the commands:

```
awplus# configure terminal
awplus(config)# router rip
awplus(config-router)# distance 8 10.0.0.0/8 mylist
```

To set the administrative distance to the default of 120 for the RIP routes within the 10.0.0.0/8 network that match the access-list `mylist`, use the commands:

```
awplus# configure terminal
awplus (config)# router rip
awplus(config-router)# no distance 8 10.0.0.0/8 mylist
```

distribute-list (RIP)

Use this command to filter incoming or outgoing route updates using the access-list or the prefix-list.

Use the **no** variant of this command to disable this feature.

Syntax `distribute-list {<access-list> | prefix <prefix-list>} {in|out}`
`[<interface>]`

`no distribute-list {<access-list> | prefix <prefix-list>} {in|out}`
`[<interface>]`

Parameter	Description
<code><access-list></code>	Specifies the IPv4 access-list number or name to use
<code>prefix</code>	Filter prefixes in routing updates
<code><prefix-list></code>	Specifies the name of the IPv4 prefix-list to use
<code>in</code>	Filter incoming routing updates
<code>out</code>	Filter outgoing routing updates
<code><interface></code>	The interface on which distribute-list applies. For instance: ■ <code>vlan2</code>

Default Disabled

Mode Router Configuration

Usage Filter out incoming or outgoing route updates using access-list or prefix-list. If you do not specify the name of the interface, the filter will be applied to all interfaces.

Example

```
awplus# configure terminal
awplus(config)# router rip
awplus(config-router)# distribute-list prefix myfilter in
vlan1
```

Related Commands [access-list \(hardware IP numbered\)](#)
[ip prefix-list](#)

ip rip authentication key-chain

Use this command to enable RIPv2 authentication on an interface and specify the name of the key chain to be used.

Use the **no** variant of this command to disable this function.

Syntax `ip rip authentication key-chain <key-chain-name>`
`no ip rip authentication key-chain`

Parameter	Description
<key-chain-name>	Specify the name of the key chain. This is an alpha-numeric string, but it cannot include spaces

Mode Interface Configuration for VLAN interfaces only.

Usage This command can only be used on VLAN interfaces. Use this command to perform authentication on the interface. Not configuring the key chain results in no authentication at all.

The AlliedWare Plus™ implementation provides the choice of configuring authentication for single key or multiple keys at different times. Use the [ip rip authentication string](#) command for single key authentication. Use the [ip rip authentication key-chain](#) command for multiple keys authentication. See [Chapter 31, RIP Configuration](#) for illustrated RIP configuration examples.

For multiple keys authentication, use the following steps to configure a route to enable RIPv2 authentication using multiple keys at different times:

Step 1: Define a key chain:

In the Configure mode, identify a key chain with a key chain name using the following command:

```
awplus# configure terminal
awplus(config)# key chain <key-chain-name>
```

where <key-chain-name> is the name of the chain to manage, and should not include spaces.

Step 2: Define the key or keys:

In the Keychain mode, specify a key on this key chain using the following command:

```
awplus(config-keychain)# key <keyid>
```

where <keyid> (a decimal number in the range 1 to 2147483647) is the Key Identifier number.

Step 3: Define the authentication string or password:

In the Keychain-key mode, define the password used by a key, using the following command:

```
awplus(config-keychain-key)# key-string <key-password>
```

where *<key-password>* is a string of characters that can contain spaces, to be used as a password by the key.

Step 4: Set key management options:

This step can be performed at this stage or later when multiple keys are used. The options are configured in the keychain-key command mode.

Set the time period during which the authentication key on a key chain is received as valid, using the [accept-lifetime](#) command:

```
awplus(config-keychain-key)# accept-lifetime <START> <END>
```

where *<START>* and *<END>* are the beginning and end of the time period.

Set the time period during which the authentication key on a key chain can be sent, using the [send-lifetime](#) command:

```
awplus(config-keychain-key)# send-lifetime <START> <END>
```

where *<START>* and *<END>* are the beginning and end of the time period.

Step 5: Enable authentication on an interface:

In the Interface mode, enable authentication on `vlan3` and specify the key chain to be used, using the following command:

```
awplusawpluls# configure terminal
awplus(config)# interface vlan3
awplus(config-if)# ip rip authentication key-chain <key-
chain-name>
```

where *<key-chain-name>* is a set of valid authentication keys.

Step 6: Specify the mode of authentication for the given interface:

In the Interface mode, specify whether the interface uses text or MD5 authentication using:

```
awplus(config-if)# ip rip authentication mode {md5|text}
```

Example In the following sample multiple keys authentication RIP configuration, a password *toyota* is set for key 1 in key chain *cars*. Authentication is enabled on *vlan1* and the authentication mode is set to MD5:

```
awplus# configure terminal
awplus(config)# key chain cars
awplus(config-keychain)# key 1
awplus(config-keychain-key)# key-string toyota
awplus(config-keychain-key)# accept-lifetime 10:00:00 Apr 08
2008 duration 43200
awplus(config-keychain-key)# send-lifetime 10:00:00 Apr 08
2008 duration 43200
awplus(config-keychain-key)# exit
awplus(config-keychain)# exit
awplus(config)# interface vlan1
awplus(config-if)# ip rip authentication key-chain
cars
awplus(config-if)# ip rip authentication mode md5
awplus(config-if)# exit
awplus(config)# exit
awplus#
```

Example In the following example, interface *vlan23* is configured to use key-chain authentication with the keychain *mykey*. See the [key](#) command for a description of how a key chain is created.

```
awplus# configure terminal
awplus(config)# interface vlan23
awplus(config-if)# ip rip authentication key-chain mykey
```

Related Commands

- [accept-lifetime](#)
- [send-lifetime](#)
- [ip rip authentication mode](#)
- [ip rip authentication string](#)
- [key](#)
- [key chain](#)

ip rip authentication mode

Use this command to specify the type of authentication mode used for RIP v2 packets.

Use the **no** variant of this command to restore clear text authentication.

Syntax `ip rip authentication mode {md5|text}`
`no ip rip authentication mode {md5|text}`

Parameter	Description
md5	Uses the keyed MD5 authentication algorithm.
text	Specifies clear text or simple password authentication.

Default Text authentication is enabled

Mode Interface Configuration for VLAN interfaces only.

Usage This command can only be configured on VLAN interfaces. The AlliedWare Plus™ implementation provides the choice of configuring authentication for single key or multiple keys at different times. Use the [ip rip authentication string](#) command for single key authentication. Use the [ip rip authentication key-chain](#) command for multiple keys authentication. See [Chapter 31, RIP Configuration](#) for illustrated RIP configuration examples.

Use the following steps to configure a route to enable RIPv2 authentication using a single key or password:

Step 1: Define the authentication string or password

In the Interface mode, specify the authentication string or password used by the key, using the following command:

```
awplus(config-if)# ip rip authentication string <auth-string>
```

where *<auth-string>* is the authentication string or password and it can include spaces.

Step 2: Specify the mode of authentication for the given interface:

In the Interface mode, specify if the interface will use text or MD5 authentication, using the following command:

```
awplus(config-if)# ip rip authentication mode {md5|text}
```

See the sample below to specify *mykey* as the authentication string with MD5 authentication:

```
awplus# configure terminal
awplus(config)# interface vlan1
awplus(config-if)# ip rip authentication string mykey
awplus(config-if)# ip rip authentication mode md5
```

For multiple keys authentication, use the following steps to configure a route to enable RIPv2 authentication using multiple keys at different times:

Step 1: Define a key chain:

In the Configure mode, identify a key chain with a key chain name using the following command:

```
awplus(config)# key chain <key-chain-name>
```

where <key-chain-name> is the name of the chain to manage, a text string with no spaces.

Step 2: Define the key or keys:

In the Keychain mode, specify a key on this key chain using the following command:

```
awplus(config-keychain)# key <keyid>
```

where <keyid> (a decimal number in the range 1 to 2147483647) is the Key Identifier number.

Step 3: Define the authentication string or password:

In the Keychain-key mode, define the password used by a key, using the following command:

```
awplus(config-keychain-key)# key-string <key-password>
```

where <key-password> is a string of characters that can include spaces, to be used as a password by the key.

Step 4: Set key management options:

This step can be performed at this stage or later when multiple keys are used. The options are configured in the keychain-key command mode.

Set the time period during which the authentication key on a key chain is received as valid, using the **accept-lifetime** command:

```
awplus(config-keychain-key)# accept-lifetime START END
```

where *START* and *END* are the beginning and end of the time period.

Set the time period during which the authentication key on a key chain can be sent, using the **send-lifetime** command:

```
awplus(config-keychain-key)# send-lifetime START END
```

where *START* and *END* are the beginning and end of the time period.

Step 5: Enable authentication on an interface:

In the Interface mode, enable authentication on an interface and specify the key chain to be used, using the following command:

```
awplus(config-if)# ip rip authentication key-chain <key-chain-name>
```

where *<key-chain-name>* is a set of valid authentication keys, as defined in Step 1.

Step 6: Specify the mode of authentication for the given interface:

In the Interface mode, specify whether the interface uses text or MD5 authentication using:

```
awplus(config-if)# ip rip authentication mode {md5|text}
```

Example In the following sample multiple keys authentication RIP configuration, a password *toyota* is set for key 1 in key chain *cars*. Authentication is enabled on *vlan1* and the authentication mode is set to MD5:

```
awplus# configure terminal
awplus(config)# key chain cars
awplus(config-keychain)# key 1
awplus(config-keychain-key)# key-string toyota
awplus(config-keychain-key)# accept-lifetime 10:00:00 Apr 08
2008 duration 43200
awplus(config-keychain-key)# send-lifetime 10:00:00 Apr 08 2008
duration 43200
awplus(config-keychain-key)# exit
awplus(config-keychain)# exit
awplus(config)# interface vlan1
awplus(config-if)# ip rip authentication key-chain
cars
awplus(config-if)# ip rip authentication mode md5
awplus(config-if)# exit
awplus(config)# exit
awplus#
```

Example The following example shows md5 authentication configured on `vlan2`, ensuring authentication of rip packets received on this interface.

```
awplus# configure terminal
awplus(config)# interface vlan2
awplus(config-if)# ip rip authentication mode md5
```

Related Commands [ip rip authentication string](#)
[ip rip authentication key-chain](#)

ip rip authentication string

Use this command to specify the authentication string or password used by a key.

Use the **no** variant of this command to remove the authentication string.

Syntax

```
ip rip authentication string <auth-string>
no ip rip authentication string <auth-string>
```

Parameter	Description
<auth-string>	The authentication string or password used by a key. It is an alpha-numeric string and can include spaces.

Mode Interface Configuration for VLAN interfaces only.

Usage This command can only be configured on VLAN interfaces. The AlliedWare Plus™ implementation provides the choice of configuring authentication for single key or multiple keys at different times. Use this command to specify the password for a single key on an interface. Use the **ip rip authentication key-chain** command for multiple keys authentication. See [Chapter 31, RIP Configuration](#) for further RIP configuration examples.

Use the following steps to configure a route to enable RIPv2 authentication using a single key or password:

Step 1: Define the authentication string or password:

In the Interface mode, specify the authentication string or password used by the key, using the following commands to configure the authentication string on `vlan3`:

```
awplus# configure terminal
awplus(config)# interface vlan3
awplus(config-if)# ip rip authentication string <auth-string>
```

where <auth-string> is the authentication string or password.

Step 2: Specify the mode of authentication for the given interface:

In the Interface mode, specify if the interface will use text or MD5 authentication, using the following command:

```
awplus(config-if)# ip rip authentication mode {md5|text}
```

Example See the example below to specify `mykey` as the authentication string with MD5 authentication:

```
awplus# configure terminal
awplus(config)# interface vlan1
awplus(config-if)# ip rip authentication string mykey
awplus(config-if)# ip rip authentication mode md5
```

Example In the following example, the interface `vlan2` is configured to have an authentication string as `guest`. Any received RIP packet in that interface should have the same string as password.

```
awplus# configure terminal
awplus(config)# interface vlan2
awplus(config-if)# ip rip authentication string guest
```

Related commands [ip rip authentication key-chain](#)
[ip rip authentication mode](#)

ip rip receive-packet

Use this command to configure the interface to enable the reception of RIP packets.

Use the **no** variant of this command to disable this feature.

Syntax `ip rip receive-packet`
`no ip rip receive-packet`

Default Receive-packet is enabled

Mode Interface Configuration for VLAN interfaces only.

Usage This command can only be configured on VLAN interfaces.

Example This example shows packet receiving being turned on for interface `vlan3`.

```
awplus# configure terminal
awplus(config)# interface vlan3
awplus(config-if)# ip rip receive-packet
```

Related Commands [ip rip send-packet](#)

ip rip receive version

Use this command to specify the version of RIP packets accepted on an interface and override the setting of the version command.

Use the **no** variant of this command to use the setting specified by the [version command on page 32.45](#).

Syntax `ip rip receive version {[1][2]}`
`no ip rip receive version`

Parameter	Description
1	Specifies acceptance of RIP version 1 packets on the interface.
2	Specifies acceptance of RIP version 2 packets on the interface.

Default Version 2

Mode Interface Configuration for VLAN interfaces only.

Usage This command can only be configured on VLAN interfaces. This command applies to a specific VLAN interface and overrides any the version specified by the **version** command.

Example In the following example, interface `vlan3` is configured to receive both RIP version 1 and 2 packets.

```
awplus# configure terminal
awplus(config)# interface vlan3
awplus(config-if)# ip rip receive version 1 2
```

Related Commands [version](#)

ip rip send-packet

Use this command to enable sending RIP packets through the current interface.

Use the **no** variant of this command to disable this feature.

Syntax `ip rip send-packet`
`no ip rip send-packet`

Default Send packet is enabled

Mode Interface Configuration for VLAN interfaces only.

Usage This command can only be configured on VLAN interfaces.

Example This example shows packet sending being turned on for interface `vlan4`.

```
awplus# configure terminal
awplus(config)# interface vlan4
awplus(config-if)# ip rip send-packet
```

Related Commands [ip rip receive-packet](#)

ip rip send version

Use this command to specify the version of RIP packets sent on an interface and override the setting of the version command.

Use the **no** variant of this command to use the setting specified by the version command.

Syntax `ip rip send version {[1][2]}`
`no ip rip send version`

Parameter	Description
1	Specifies sending of RIP version 1 packets out of an interface.
2	Specifies sending of RIP version 2 packets out of an interface.

Default Version 2

Mode Interface Configuration for VLAN interfaces only.

Usage This command can only be configured on VLAN interfaces. This command applies to a specific interface and overrides any the version specified by the **version** command.

Example In the following example, interface `vlan4` is configured to send both RIP version 1 and 2 packets.

```
awplus# configure terminal
awplus(config)# interface vlan4
awplus(config-if)# ip rip send version 1 2
```

ip rip send version 1-compatible

Use this command to send RIP version 1 compatible packets from a version 2 RIP interface. This mechanism causes version 2 RIP to broadcast the packets instead of multicasting them.

Use the **no** variant of this command to use the global RIP version control rules.

Syntax `ip rip send version 1-compatible`

Default Disabled

Mode Interface Configuration for VLAN interfaces only.

Usage This command can only be configured on VLAN interfaces.

Example In the following example, interface `vlan2` is configured to send RIP version 1-compatible packets; so it broadcasts both RIP version 1 and 2 packets.

```
awplus# configure terminal
awplus(config)# interface vlan2
awplus(config-if)# ip rip send version 1-compatible
```

ip rip split-horizon

Use this command to perform the split-horizon action on the interface. The default is split-horizon poisoned.

Use the **no** variant of this command to disable this function.

Syntax `ip rip split-horizon [poisoned]`
`no ip rip split-horizon`

Parameter	Description
<code>poisoned</code>	Performs split-horizon with poisoned reverse.

Default Split horizon poisoned is the default.

Mode Interface Configuration for VLAN interfaces only.

Usage This command can only be configured on VLAN interfaces. Use this command to avoid including routes in updates sent to the same gateway from which they were learned. Using the **split horizon** command omits routes learned from one neighbor, in updates sent to that neighbor. Using the **poisoned** parameter with this command includes such routes in updates, but sets their metrics to infinity. Thus, advertising that these routes are not reachable.

Example

```
awplus# configure terminal
awplus(config)# interface vlan2
awplus(config-if)# ip rip split-horizon poisoned
```

key

Use this command to manage, add and delete authentication keys in a key-chain.

Use the **no** variant of this command to delete the authentication key.

Syntax `key <keyid>`
`no key <keyid>`

Parameter	Description
<code><keyid></code>	<code><0-2147483647></code> Key identifier number

Mode Keychain Configuration

Usage This command allows you to enter the keychain-key mode where a password can be set for the key.

Example The following example configures a key number 1 and shows the change into a **keychain-key** command mode prompt.

```
awplus# configure terminal
awplus(config)# key chain mychain
awplus(config-keychain)# key 1
awplus(config-keychain-key)#
```

Related Commands [key chain](#)
[key-string](#)
[accept-lifetime](#)
[send-lifetime](#)

key chain

Use this command to enter the key chain management mode and to configure a key chain with a key chain name.

Use the **no** variant of this command to remove the key chain and all configured keys.

Syntax `key chain <key-chain-name>`
`no key chain <key-chain-name>`

Parameter	Description
<code><key-chain-name></code>	Specify the name of the key chain to manage.

Mode Global Configuration

Usage This command allows you to enter the keychain mode from which you can specify keys on this key chain.

Example The following example shows the creation of a key chain named `mychain` and the change into `keychain` mode prompt.

```
awplus# configure terminal
awplus(config)# key chain mychain
awplus(config-keychain)#
```

Related Commands `key`
`key-string`
`accept-lifetime`
`send-lifetime`

key-string

Use this command to define the password to be used by a key.

Use the **no** variant of this command to remove a password.

Syntax `key-string <key-password>`
`no key-string <key-password>`

Parameter	Description
<code><key-password></code>	A string of characters to be used as a password by the key.

Mode Keychain-key Configuration

Usage Use this command to specify passwords for different keys.

Example In the following example, the password for `key1` in the key chain named `mychain` is set to password `prime`.

```
awplus# configure terminal
awplus(config)# key chain mychain
awplus(config-keychain)# key 1
awplus(config-keychain-key)# key-string prime
```

Related Commands [key](#)
[key chain](#)
[accept-lifetime](#)
[send-lifetime](#)

maximum-prefix

Use this command to configure the maximum number of RIP routes stored in the routing table.

Use the **no** variant of this command to disable all limiting of the number of RIP routes stored in the routing table.

Syntax `maximum-prefix <maxprefix> [<threshold>]`

`no maximum-prefix`

Parameter	Description
<code><maxprefix></code>	<code><1-65535></code> The maximum number of RIP routes allowed.
<code><threshold></code>	<code><1-100></code> Percentage of maximum routes to generate a warning. The default threshold is 75%.

Mode Router Configuration

Example

```
awplus# configure terminal
awplus(config)# router rip
awplus(config-router)# maximum-prefix 150
```

neighbor (RIP)

Use this command to specify a neighbor router. It is used for each router to which you wish to send unicast RIP updates.

Use the **no** variant of this command to stop sending unicast updates to the specific router.

Syntax `neighbor <ip-address>`
`no neighbor <ip-address>`

Parameter	Description
<code><ip-address></code>	The IP address of a neighboring router with which the routing information will be exchanged.

Default Disabled

Mode Router Configuration

Usage Use this command to exchange nonbroadcast routing information. It can be used multiple times for additional neighbors.

The [passive-interface \(RIP\)](#) command disables sending routing updates on an interface. Use the `neighbor` command in conjunction with the [passive-interface \(RIP\)](#) to send routing updates to specific neighbors.

Example

```
awplus# configure terminal
awplus(config)# router rip
awplus(config-router)# passive-interface vlan1
awplus(config-router)# neighbor 1.1.1.1
```

Related Commands [passive-interface \(RIP\)](#)

network (RIP)

Use this command to specify a network or VLAN as one that runs Routing Information Protocol (RIP).

Use the **no** variant of this command to remove the specified network or VLAN as one that runs RIP.

Syntax `network {<network-address> [/<subnet-mask>] | <vlan-name>}`
`no network {<network-address> [/<subnet-mask>] | <vlan-name>}`

Parameter	Description
<code><network-address></code> <code>[/<subnet-mask>]</code>	Specifies the network address to run RIP. Entering a subnet mask for the network address is optional. Note that a subnet mask for a network address is shown in the running-config if a subnet mask is not specified for a network address using this command.
<code><vlan-name></code>	Specify a VLAN name with up to 32 alphanumeric characters to run RIP.

Default Disabled

Mode Router Configuration and Address Family Configuration

Usage Use this command to specify networks, or VLANs, to which routing updates will be sent and received. The connected routes corresponding to the specified network, or VLANs, will be automatically advertised in RIP updates. RIP updates will be sent and received within the specified network or VLAN.

Example

```
awplus# configure terminal
awplus(config)# router rip
awplus(config-router)# network 10.0.0.0/8
awplus(config-router)# network vlan2
```

Related Commands `show ip rip`
`show running-config`
`clear ip rip route`

offset-list (RIP)

Use this command to add an offset to **in** and **out** metrics to routes learned through RIP.

Use the **no** variant of this command to remove the offset list.

Syntax `offset-list <access_list> {in|out} <offset> [<interface>]`
`no offset-list <access_list> {in|out} <offset> [<interface>]`

Parameter	Description
<code><access_list></code>	Specifies the access-list number or names to apply.
<code>in</code>	Indicates the access list will be used for metrics of incoming advertised routes.
<code>out</code>	Indicates the access list will be used for metrics of outgoing advertised routes.
<code><offset></code>	<code><0-16></code> Specifies that the offset is used for metrics of networks matching the access list.
<code><interface></code>	An alphanumeric string that specifies the interface to match.

Default The default `offset` value is the metric value of the interface over which the updates are being exchanged.

Mode Router Configuration and Address Family Configuration

Usage Use this command to specify the offset value that is added to the routing metric. When the networks match the access list the offset is applied to the metrics. No change occurs if the offset value is zero.

Example In this example the router examines the RIP updates being sent out from interface `vlan2` and adds 5 hops to the routes matching the ip addresses specified in the access list 1.

```
awplus# configure terminal
awplus(config)# router rip
awplus(config-router)# offset-list 1 in 5 vlan2
```

Related Commands [access-list \(extended numbered\)](#)
[access-list \(standard numbered\)](#)

passive-interface (RIP)

Use this command to block RIP broadcasts on the VLAN interface.

Use the **no** variant of this command to disable this function

Syntax `passive-interface <interface>`
`no passive-interface <interface>`

Parameter	Description
<code><interface></code>	Specifies the interface name.

Default Disabled

Mode Router Configuration

Usage This command can only be configured for VLAN interfaces.

Example

```
awplus# configure terminal
awplus(config)# router rip
awplus(config-router)# passive-interface vlan20
```

Related Commands [show ip rip](#)

recv-buffer-size (RIP)

Use this command to run-time configure the RIP UDP (User Datagram Protocol) receive-buffer size to improve UDP reliability by avoiding UDP receive buffer overrun.

Use the **no** variant of this command to reset the configured RIP UDP receive-buffer size to the system default value (196608 bits).

Syntax `recv-buffer-size <8192-2147483647>`

`no recv-buffer-size`

Default 196608 bits is the system default value when reset using the **no** variant of this command.

Mode Router Configuration

Example

```
awplus# configure terminal
awplus(config)# router rip
awplus(config-router)# recv-buffer-size 23456789
```

redistribute (RIP)

Use this command to redistribute information from other routing protocols into RIP.

Use the **no** variant of this command to disable the specified redistribution. The parameters **metric** and **routemap** may be used on this command, but have no effect.

Syntax `redistribute {connected|static|ospf|bgp} [metric <0-16>] [routemap <routemap>]`

`no redistribute {connected|static|ospf|bgp} [metric] [routemap]`

Parameter	Description
<code>metric</code>	Specifies the metric value to be applied to the redistributed routes
<code><0-16></code>	Metric value
<code>routemap</code>	route-map WORD Specifies route-map that controls how routes are redistributed
<code><routemap></code>	The name of the route map
<code>connected</code>	redistribute from connected routes
<code>static</code>	redistribute from static routes
<code>ospf</code>	redistribute from Open Shortest Path First (OSPF)
<code>bgp</code>	redistribute from Border Gateway Protocol (BGP)

Mode Router Configuration

Example

```
awplus# configure terminal
awplus(config)# router rip
awplus(config-router)# redistribute static metric 15 route-map
Chicago
```

restart rip graceful

Use this command to force the RIP process to restart.

Syntax `restart rip graceful [grace-period <1-65535>]`

Mode Privileged Exec

Usage After this command is executed, the RIP process immediately shuts down. It notifies the system that RIP has performed a graceful shutdown. Routes that have been installed into the route table by RIP are preserved until the specified grace-period expires.

- When a `restart rip graceful` command is issued, the RIP configuration is reloaded from the last saved configuration. Ensure you first enter the command `copy running-config startup-config`.

Example

```
awplus# copy running-config startup-config
awplus# restart rip graceful grace-period 100
```

rip restart grace-period

Use this command to change the grace period of RIP graceful restart.

Use the `no` variant of this command to disable this function.

Syntax `rip restart grace-period <1-65535>`
`no rip restart grace-period <1-65535>`

Mode Global Configuration

Usage Use this command to enable the **Graceful Restart** feature on the RIP process. Entering this command configures a grace period for RIP.

Example

```
awplus# configure terminal
awplus(config)# rip restart grace-period 200
```

route (RIP)

Use this command to configure static RIP routes.

Use the **no** variant of this command to disable this function.

Syntax `route <ip-addr/prefix-length>`
`no route <ip-addr/prefix-length>`

Parameter	Description
<code><ip-addr/prefix-length></code>	The IPv4 address and prefix length.

Default No static RIP route is added by default.

Mode Router Configuration

Usage Use this command to add a static RIP route. After adding the RIP route, the route can be checked in the RIP routing table.

Example

```
awplus# configure terminal
awplus(config)# router rip
awplus(config-router)# route 1.2.3.4/8
```

Related Commands `show ip rip`
`clear ip rip route`

router rip

Use this global command to enter Router Configuration mode to enable the RIP routing process.

Use the **no** variant of this command to disable the RIP routing process.

Syntax `router rip`

`no router rip`

Mode Global Configuration

Example This command is used to begin the RIP routing process:

```
awplus# configure terminal
awplus(config)# router rip
awplus(config-router)# version 1
awplus(config-router)# network 10.10.10.0/24
awplus(config-router)# network 10.10.11.0/24
awplus(config-router)# neighbor 10.10.10.10
```

Related Commands `network (RIP)`
`version`

send-lifetime

Use this command to specify the time period during which the authentication key on a key chain can be sent.

Syntax `send-lifetime <start-date>{<end-date>|duration <seconds>|infinite}`
`no send-lifetime`

Parameter	Description
<code><start-date></code>	Specifies the start period - time and date in the format DD MMM YYYY or MMM DD YYYY: <code><hh:mm:ss> {<day> <month> <year> <month> <day> <year>}</code>
<code><hh:mm:ss></code>	Time of the day when send-lifetime starts, in hours, minutes and seconds
<code><day></code>	<1-31> Specifies the day of the month to start.
<code><month></code>	Specifies the month of the year to start (the first three letters of the month, for example, Jan).
<code><year></code>	<1993-2035> Specifies the year to start.
<code><end-date></code>	Specifies the end period - time and date in the format DD MMM YYYY or MMM DD YYYY: <code><hh:mm:ss> {<day> <month> <year> <month> <day> <year>}</code>
<code><hh:mm:ss></code>	Time of the day when lifetime expires, in hours, minutes and seconds.
<code><day></code>	<1-31> Specifies the day of the month to expire.
<code><month></code>	Specifies the month of the year to expire (the first three letters of the month, for example, Feb).
<code><year></code>	<1993-2035> Specifies the year to expire.
<code><seconds></code>	<1-2147483646> Duration of the key in seconds.
<code>infinite</code>	Never expires.

Mode Keychain-key Configuration

Example The following example shows the setting of send-lifetime for `key1` on the key chain named `mychain`.

```
awplus# configure terminal
awplus(config)# key chain mychain
awplus(config-keychain)# key 1
awplus(config-keychain-key)# send-lifetime 03:03:01 Jan 3 2004
04:04:02 Dec 6 2006
```

Related Commands [key](#)
[key-string](#)
[key chain](#)
[accept-lifetime](#)

show debugging rip

Use this command to display the RIP debugging status for these debugging options: nsm debugging, RIP event debugging, RIP packet debugging and RIP nsm debugging.

For information on output options, see [“Controlling “show” Command Output” on page 1.35.](#)

Syntax `show debugging rip`

Mode Privileged Exec

Usage Use this command to display the debug status of RIP.

Example

```
awplus# show debugging rip
```

show ip protocols rip

Use this command to display RIP process parameters and statistics.

For information on output options, see [“Controlling “show” Command Output” on page 1.35.](#)

Syntax `show ip protocols rip`

Mode User Exec and Privileged Exec

Example

```
awplus# show ip protocols rip
```

Output Figure 32-1: Example output from the `show ip protocols rip` command:

```
Routing Protocol is "rip"
Sending updates every 30 seconds with +/-50%, next due in 12
seconds
Timeout after 180 seconds, garbage collect after 120 seconds
Outgoing update filter list for all interface is not set
Incoming update filter list for all interface is not set
Default redistribution metric is 1
Redistributing: connected static
Default version control: send version 2, receive version 2
Interface          Send  Recv  Key-chain
  vlan25           2    2
Routing for Networks:
  10.10.0.0/24
Routing Information Sources:
  Gateway          BadPackets BadRoutes  Distance Last Update
Distance: (default is 120)
```

show ip rip

Use this command to show RIP routes.

For information on output options, see [“Controlling “show” Command Output”](#) on page 1.35.

Syntax show ip rip

Mode User Exec and Privileged Exec

Example

```
awplus# show ip rip
```

Output Figure 32-2: Example output from the **show up rip** command

```
awplus#show ip rip
Codes: R - RIP, Rc - RIP connected, Rs - RIP static
       C - Connected, S - Static, O - OSPF, B - BGP
Network      Next Hop Metric From If   Time
C 10.0.1.0/24          1      vlan20
S 10.10.10.0/24       1      vlan20
C 10.10.11.0/24       1      vlan20
S 192.168.101.0/24   1      vlan20
R 192.192.192.0/24   1      --
```

Related Commands route (RIP)
network (RIP)
clear ip rip route

Equivalent Command show ip rip database

show ip rip database

Use this command to display information about the RIP database.

For information on output options, see [“Controlling “show” Command Output”](#) on page 1.35.

Syntax show ip rip database

Mode User Exec and Privileged Exec

Example

```
awplus# show ip rip database
```

Related Commands show ip rip

show ip rip interface

Use this command to display information about the RIP interfaces. You can specify an interface name to display information about a specific interface.

For information on output options, see [“Controlling “show” Command Output” on page 1.35.](#)

Syntax `show ip rip interface [<interface>]`

Parameter	Description
<interface>	The interface to display information about. For instance: ■ vlan2

Mode User Exec and Privileged Exec

Example The following is the output from the show ip rip interface command. This output shows the RIP related configuration of each IP interface.

```
awplus# show ip rip interface
```

timers (RIP)

Use this command to adjust routing network timers.

Use the **no** variant of this command to restore the defaults.

Syntax `timers basic <update> <timeout> <garbage>`
`no timers basic`

Parameter	Description
<code><update></code>	<code><5-2147483647></code> Specifies the period at which RIP route update packets are transmitted. The default is 30 seconds.
<code><timeout></code>	<code><5-2147483647></code> Specifies the routing information timeout timer in seconds. The default is 180 seconds. After this interval has elapsed and no updates for a route are received, the route is declared invalid.
<code><garbage></code>	<code><5-2147483647></code> Specifies the routing garbage collection timer in seconds. The default is 120 seconds.

Default Enabled

Mode Router Configuration

Usage This command adjusts the RIP timing parameters.

The update timer is the time between sending out updates, that contain the complete routing table, to every neighboring router.

If an update for a given route has not been seen for the time specified by the timeout parameter, that route is no longer valid. However, it is retained in the routing table for a short time, with metric 16, so that neighbors are notified that the route has been dropped.

When the time specified by the garbage parameter expires the metric 16 route is finally removed from the routing table. Until the garbage time expires, the route is included in all updates sent by the router.

All the routers in the network must have the same timers to ensure the smooth operation of RIP throughout the network.

Example

```
awplus# configure terminal
awplus(config)# router rip
awplus(config-router)# timers basic 30 180 120
```

undebg rip

Use this command to disable the options set for debugging information of RIP events, packets and communication between RIP and NSM.

This command has the same effect as the **no debug rip** command.

Syntax `undebg rip {all|events|nsm|<packet>}`

Parameter	Description
<code>all</code>	Disables all RIP debugging.
<code>events</code>	Disables the logging of RIP events.
<code>nsm</code>	Disables the logging of RIP and NSM communication.
<code><packet></code>	<code>packet [recv send] [detail]</code> Disables the debugging of RIP packets.
<code>recv</code>	Disables the logging of received packet information.
<code>send</code>	Disables the logging of sent packet information.
<code>detail</code>	Disables the logging of sent or received RIP packets.

Mode Privileged Exec

Example

```
awplus# undebg rip packet
```

version

Use this command to specify a RIP version used globally by the router.

Use the **no** variant of this command to restore the default version.

Syntax `version {1|2}`
`no version`

Parameter	Description
1 2	Specifies the version of RIP processing. Default is RIP v2.

Default Version 2

Mode Router Configuration

Usage RIP can be run in version 1 or version 2 mode. Version 2 has more features than version 1; in particular RIP version 2 supports authentication. Once the `rip version` is set, RIP packets of that version will be received and sent on all the RIP-enabled interfaces.

The `ip rip receive version` command and the `ip rip send version` command override the value set by this command.

Example

```
awplus# configure terminal
awplus(config)# router rip
awplus(config-router)# version 1
```

Validation Commands `show running-config`

```
awplus# show running-config
```

```
!
router rip
 version 1
!
```

Related Commands `ip rip receive version`
`ip rip send version`

Chapter 33: RIPng Configuration



Introduction.....	33.2
Enabling RIPng.....	33.2
Troubleshooting RIPng Adjacency.....	33.4

Introduction

This chapter contains a basic RIPng configuration example. To see details on the RIPng commands used in these examples, or to see the outputs of the Validation commands, refer to [Chapter 34, RIPng Commands](#).

Enabling RIPng

This example shows the minimum configuration required for enabling RIPng on an interface. Switch 1 and Switch 2 are two switches connected via network `2001:db8:11::/64`.

To enable RIPng, first define the RIPng routing process and then enable RIPng on each interface.

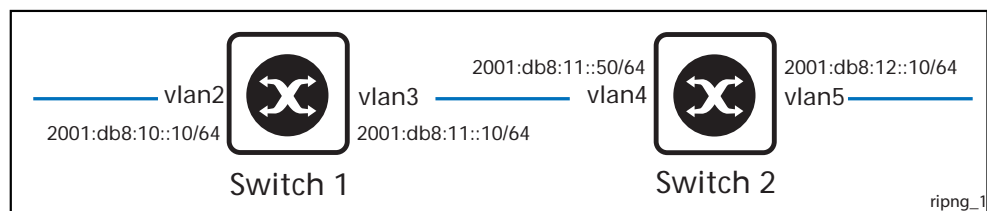

Switch 1

```

awplus#
configure terminal Enter the Global Configuration mode.
-----
awplus(config)#
interface vlan2 Specify the interface (vlan2) and enter the Interface
                  Configuration mode.
-----
awplus(config-if)#
ipv6 router rip Enable RIPng routing on interface vlan2.
-----
awplus(config-if)#
exit Exit Interface mode and enter Global Configuration mode.
-----
awplus(config)#
interface vlan3 Specify the interface (vlan3) and enter the Interface
                  Configuration mode.
-----
awplus(config-if)#
ipv6 router rip Enable RIPng routing on interface vlan3.
-----
awplus(config-if)#
exit Exit Interface mode and enter Global Configuration mode.
-----
awplus(config)#
router ipv6 rip Define a RIPng routing process and enter Router
                  Configuration mode.
-----
awplus(config-router)#
route 2001:db8:11::/64 Define a static RIPng route to connect Switch 1 to
                       Switch 2 using the IPv6 network address
                       2001:db8:11::/64

```

Switch 2

awplus#	
configure terminal	Enter the Global Configuration mode.
<hr/>	
awplus(config)#	
interface vlan5	Specify the interface (vlan5) and enter the Interface Configuration mode.
<hr/>	
awplus(config-if)#	
ipv6 router rip	Enable RIPng routing on interface vlan5
<hr/>	
awplus(config-if)#	
exit	Exit Interface mode and enter Global Configuration mode.
<hr/>	
awplus(config)#	
interface vlan4	Specify the interface (vlan4) and enter the Interface Configuration mode.
<hr/>	
awplus(config-if)#	
ipv6 router rip	Enable RIPng routing on interface vlan4.
<hr/>	
awplus(config-if)#	
exit	Exit Interface mode and enter Global Configuration mode.
<hr/>	
awplus(config)#	
router ipv6 rip	Define a RIPng routing process and enter Router Configuration mode.
<hr/>	
awplus(config-router)#	
route 2001:db8:11::/64	Define a static RIPng route to connect Switch 2 to Switch 1 using the IPv6 network address 2001:db8::11/64

Names of Commands Used

```
router ipv6 rip
ipv6 router rip
```

Validation Commands

```
show ipv6 rip
```

Troubleshooting RIPng Adjacency

Follow the steps below to troubleshoot RIPng adjacency:

Step 1. Confirm the Interface is not shutdown

<code>awplus#</code>	Enter the Global Configuration mode.
<code>configure terminal</code>	
<code>awplus(config)#</code>	Specify the interface (v1an2) and enter the Interface mode.
<code>interface v1an2</code>	
<code>awplus(config-if)#</code>	Ensure the interface is not administratively shutdown.
<code>no shutdown</code>	
<code>awplus(config-if)#</code>	Exit Interface Configuration mode and enter Global Configuration mode.
<code>exit</code>	
<code>awplus(config)#</code>	Exit Global Configuration mode and return to Privileged Exec mode.
<code>exit</code>	
<code>awplus#</code>	Use the <code>show interface</code> command to make sure that the interface is not administratively shutdown.
<code>show ipv6 interface brief</code>	

Step 2. Confirm RIPng is enabled on the interface

<code>awplus#</code>	Enter the Global Configuration mode.
<code>configure terminal</code>	
<code>awplus(config)#</code>	Specify the interface (v1an2) and enter the Interface Configuration mode.
<code>interface v1an2</code>	
<code>awplus(config-if)#</code>	Enable RIPng routing on interface v1an2.
<code>ipv6 router rip</code>	
<code>awplus(config-if)#</code>	Exit Interface Configuration mode and enter Global Configuration mode.
<code>exit</code>	
<code>awplus(config)#</code>	Exit Global Configuration mode and return to Privileged Exec mode.
<code>exit</code>	
<code>awplus#</code>	
<code>show ipv6 rip interface v1an2</code>	Check the configuration. E.g.: v1an2 is up, line protocol is up Routing Protocol: RIPng Passive interface: Disabled Split horizon: Enabled with Poisoned Reversed IPv6 interface address: 2001:db8:1::10/64 2001:db8:204:76ff:fec8::/10

Step 3. Check the Interface is not a Passive Interface

<pre>awplus# show running-config</pre>	<p>Check that the interface is not configured as a passive interface.</p> <p>If it is configured to be passive, this is displayed in the output from the show running config command, e.g:</p> <pre>! router ipv6 rip passive interface vlan2 !</pre>
<pre>awplus# configure terminal</pre>	<p>Enter the Global Configuration mode.</p>
<pre>awplus(config)# router ipv6 rip</pre>	<p>Enter the Router Configuration mode.</p>
<pre>awplus(config-router)# no passive interface port1.0.1</pre>	<p>Remove the passive interface.</p>

Step 4. Ensure RIPng Advertisements get exchanged

<pre>awplus# configure terminal</pre>	<p>Enter the Global Configuration mode.</p>
<pre>awplus(config)# debug ipv6 rip event</pre>	<p>Check on the interface to make sure that RIPng advertisements are being sent and received.</p>
<pre>awplus(config)# debug ipv6 rip packet detail</pre>	<p>Check on the interface to make sure that RIPng advertisements are being sent and received.</p>
<pre>awplus(config)# exit</pre>	<p>Exit Global Configuration mode to enter Privileged Exec mode.</p>
<pre>awplus# terminal monitor</pre>	<p>View log messages, or use a packet sniffer such as Ethereal or Wireshark, to verify RIPng advertisements.</p>

Chapter 34: RIPng Commands



Introduction.....	34.2
Command List.....	34.2
aggregate-address (RIPng).....	34.2
cisco-metric-behavior (RIPng).....	34.3
clear ipv6 rip route.....	34.5
debug ipv6 rip.....	34.6
default-information originate (RIPng).....	34.7
default-metric (RIPng).....	34.7
distribute-list (RIPng).....	34.9
ipv6 rip split-horizon.....	34.10
ipv6 router rip.....	34.11
neighbor (RIPng).....	34.12
offset-list (RIPng).....	34.13
passive-interface (RIPng).....	34.14
recv-buffer-size (RIPng).....	34.15
redistribute (RIPng).....	34.16
route (RIPng).....	34.17
router ipv6 rip.....	34.18
show debugging ipv6 rip.....	34.18
show ipv6 protocols rip.....	34.19
show ipv6 rip.....	34.20
show ipv6 rip database.....	34.21
show ipv6 rip interface.....	34.22
timers (RIPng).....	34.23
undebug ipv6 rip.....	34.24

Introduction

This chapter contains AlliedWare Plus™ RIPng commands. RIPng (Routing Information Protocol next generation) is an extension of RIPv2 to support IPv6. RFC 2080 specifies RIPng. The differences between RIPv2 and RIPng are:

- RIPng does not support RIP updates authentication
- RIPng does not allow the attachment of arbitrary tags to routes
- RIPng requires the encoding of the next-hop for a set of routes

For more information, see [Chapter 33, RIPng Configuration](#).

Command List

This section provides an alphabetical reference of commands used to configure RIPng for IPv6.

aggregate-address (RIPng)

Use this command to aggregate RIPng routes.

Use the **no** variant of this command to disable this feature.

Syntax `aggregate-address <ipv6-addr/prefix-length>`
`no aggregate-address <ipv6-addr/prefix-length>`

Parameter	Description
<code><ipv6-addr/prefix-length></code>	Specify the IPv6 Address in the format <code>X:X::X:Prefix-Length</code> . The prefix-length is a decimal integer between 1 and 128.

Mode Router Configuration

Example

```
awplus# configure terminal
awplus(config)# router ipv6 rip
awplus(config-router)# aggregate-address 2001:db8::/32
```

cisco-metric-behavior (RIPng)

Use this command to enable or disable the RIPng routing metric update to conform to Cisco's implementation. The Cisco implementation sets the metric of redistributed connected and static RIPng routes to 0 by default. Note that AlliedWare Plus sets the metric to 1 by default when using the **default-metric (RIPng)** command.

Use the **no** variant of this command to disable this feature.

Syntax `cisco-metric-behavior {enable|disable}`
`no cisco-metric-behavior`

Parameter	Description
<code>enable</code>	Enables updating the metric consistent with Cisco.
<code>disable</code>	Disables updating the metric consistent with Cisco.

Default By default, the Cisco metric-behavior is disabled. Note the difference between the metric applied with the **default-metric (RIPng)** command, and the metric applied with this command.

Mode Router Configuration

Usage When a RIPng device with **cisco metric-behavior** enabled sends an update, it adds the metric of the outgoing interface to the update, and the receiver of the update accepts the metric sent. Less routing control is given to the local router, because the local router adopts the sent metric.

When a RIPng device with **cisco metric-behavior** disabled sends an update, this behavior is reversed so the receiving RIPng device adds the interface metric on which the update arrived onto the metric contained in the update. More routing control is given to the local router, so the local router can change its interface metric setting to prefer routes from one interface over another. See the **default-metric (RIPng)** command description for further information.

Examples To enable the routing metric update to behave as per the Cisco implementation, enter the command:

```
awplus# configure terminal
awplus(config)# router ipv6 rip
awplus(config-router)# cisco-metric-behavior enable
```

To disable the routing metric update to behave as per the Cisco implementation, enter the command:

```
awplus# configure terminal
awplus(config)# router ipv6 rip
awplus(config-router)# cisco-metric-behavior disable
```

To disable the routing metric update as Cisco to behave as per the Cisco implementation, enter the command:

```
awplus# configure terminal
awplus(config)# router ipv6 rip
awplus(config-router)# no cisco-metric-behavior
```

**Validation
Commands** show running-config

Related Commands cisco-metric-behavior (RIP)
default-metric (RIPng)

clear ipv6 rip route

Use this command to clear specific data from the RIPng routing table.

Syntax `clear ipv6 rip route {<ipv6-addr/prefix-length>|all|connected|rip|static}`

Parameter	Description
<code><ipv6-addr/prefix-length></code>	Specify the IPv6 Address in format <i>X::X::X:Prefix-Length</i> . The prefix-length is a decimal integer between 1 and 128. Removes entries which exactly match this destination address from the RIPng routing table.
<code>connected</code>	Removes redistributed connected entries from RIPng routing table.
<code>static</code>	Removes redistributed static entries from the RIPng routing table.
<code>rip</code>	Removes RIPng routes from the RIPng routing table.
<code>all</code>	Clears the entire RIPng routing table.

Mode Privileged Exec

Example

```
awplus# clear ipv6 rip route all
awplus# clear ipv6 rip route 2001:db8::/32
```

debug ipv6 rip

Use this command to enable RIPng debugging and specify debugging for RIPng events, RIPng packets, or RIPng communication with NSM processes.

Use the **no** variant of this command to disable RIPng debugging.

Syntax `debug ipv6 rip [all|events|nsm|packet [detail]|recv [detail]|send [detail]]`
`no debug ipv6 rip [all|events|nsm|packet [detail]|recv [detail]|send [detail]]`

Parameter	Description
all	Displays all RIPng debugging showing RIPng events debug information, RIPng received packets information, and RIPng sent packets information.
events	Displays RIPng events debug information.
nsm	Displays RIPng and NSM communication.
packet	Displays RIPng packets only.
recv	Optional. Displays information for received packets.
send	Optional. Displays information for sent packets.
detail	Optional. Displays detailed information for the sent or received packet.

Default RIPng debugging is disabled by default.

Mode Privileged Exec and Global Configuration

Example

```
awplus# debug ipv6 rip events
awplus# debug ipv6 rip packet send detail
awplus# debug ipv6 rip nsm
```

Related Commands [undebug ipv6 rip](#)

default-information originate (RIPng)

Use this command to generate a default route into RIPng.

Use the **no** variant of this command to disable this feature.

Syntax `default-information originate`
`no default-information originate`

Default Disabled

Mode Router Configuration

Example

```
awplus# configure terminal
awplus(config)# router ipv6 rip
awplus(config-router)# default-information originate
```

default-metric (RIPng)

Use this command to specify the metrics to be assigned to redistributed routes.

Use the **no** variant of this command to reset the metric back to its default value (1).

Syntax `default-metric <1-16>`
`no default-metric [<1-16>]`

Parameter	Description
<1-16>	Metric value.

Default By default, the metric value is set to 1, the default administrative distance for a static route.

Mode Router Configuration

Usage This command is used with the [redistribute \(RIPng\)](#) command to make the routing protocol use the specified metric value for all redistributed routes. Default metric is useful in redistributing routes with incompatible metrics. Every protocol has different metrics and can not be compared directly. Default metric provides the standard to compare. All routes that are redistributed will use the default metric. See the [Administrative Distance](#) section in [Chapter 29, Route Selection](#) for further information about default route metrics for protocols.

When a RIPng device receives an update, it adds the interface metric on which the update arrived onto the metric contained in the update. This gives more routing control to the local router to change its interface metric setting to prefer routes from one interface over another.

Note that the [cisco-metric-behavior \(RIPng\)](#) command is an alternative to this command, and reverses this behavior by having the device that sends the update add the metric of the outgoing interface to the update, then the receiver adopts the metric that was sent from the sender. This gives less control to the local router to prefer routes from one interface over another. See the [cisco-metric-behavior \(RIPng\)](#) command description for further information.

Example

```
awplus# configure terminal
awplus(config)# router ipv6 rip
awplus(config-router)# default-metric 8
```

Related Commands [cisco-metric-behavior \(RIPng\)](#)

distribute-list (RIPng)

Use this command to filter incoming or outgoing route updates using the access-list or the prefix-list.

Use the **no** variant of this command to disable this feature.

Syntax `distribute-list [<access-list>|prefix <prefix-list-name>] [in|out]
[<interface>]`

`no distribute-list [<access-list>|prefix <prefix-list-name>] [in|out]
[<interface>]`

Parameter	Description
<code><access-list></code>	Optional. Specifies the IPv6 access-list number or name to use.
<code><prefix-list-name></code>	Optional. Filter prefixes in routing updates. Specify the name of the IPv6 prefix-list to use.
<code><interface></code>	The interface for which distribute-list applies. For instance: ■ <code>vlan2</code>
<code>in</code>	Optional. Filter incoming routing updates.
<code>out</code>	Optional. Filter outgoing routing updates.

Default Disabled

Mode Router Configuration

Usage Filter out incoming or outgoing route updates using the access-list or the prefix-list. If you do not specify the name of the interface, the filter is applied to all the interfaces.

Example

```
awplus# configure terminal
awplus(config)# router ipv6 rip
awplus(config-router)# distribute-list prefix myfilter in vlan2
```

Related Commands [ipv6 access-list extended \(named\)](#)
[ipv6 nd prefix](#)

ipv6 rip split-horizon

Use this command to perform the split-horizon action on the interface. The default is split-horizon with poisoned reverse.

Use the **no** variant of this command to disable this function.

Syntax `ipv6 rip split-horizon [poisoned]`
`no ipv6 rip split-horizon`

Parameter	Description
<code>split-horizon</code>	Required. Perform split-horizon without poisoned reverse
<code>poisoned</code>	Optional. Performs split-horizon with poisoned reverse.

Default Split-horizon with poisoned reverse is the default.

Mode Interface Configuration for VLAN interfaces only.

Usage This command can only be configured on VLAN interfaces. Use this command to avoid including routes in updates sent to the same gateway from which they were learned. Using the **split horizon** command omits routes learned from one neighbor, in updates sent to that neighbor. Using the **poisoned** parameter with this command includes such routes in updates, but sets their metrics to infinity. Thus, advertising that these routes are not reachable.

Examples

```
awplus# configure terminal
awplus(config)# interface vlan2
awplus(config-if)# ipv6 rip split-horizon
```

```
awplus# configure terminal
awplus(config)# interface vlan2
awplus(config-if)# ipv6 rip split-horizon poisoned
```

```
awplus# configure terminal
awplus(config)# interface vlan2
awplus(config-if)# no ipv6 rip split-horizon
```

Validation Commands `show running-config`

ipv6 router rip

Use this command to enable RIPng routing on the interface.

Use the **no** variant of this command to disable RIPng routing.

Syntax `ipv6 router rip`
`no ipv6 router rip`

Default Disabled

Mode Interface Configuration for VLAN interfaces only.

Usage This command can only be configured on VLAN interfaces.

Examples

```
awplus# configure terminal
awplus(config)# interface vlan2
awplus(config-if)# ipv6 router rip
```

```
awplus# configure terminal
awplus(config)# interface vlan2
awplus(config-if)# no ipv6 router rip
```

neighbor (RIPng)

Use this command to specify a neighbor router.

Use the **no** variant of this command to disable the specific router.

Syntax `neighbor <ipv6-link-local-addr> <interface>`
`no neighbor <ipv6-link-local-addr> <interface>`

Parameter	Description
<code><ipv6-link-local-addr></code>	Specify the link-local IPv6 address (in the format X:X::X:X) of a neighboring router to exchange routing information with.
<code><interface></code>	The interface. For instance: <ul style="list-style-type: none"> ■ <code>vlan2</code>

Mode Router Configuration

Usage Use this command to exchange non broadcast routing information. It can be used multiple times for additional neighbors.

The [passive-interface \(RIPng\)](#) command disables sending routing updates on an interface. Use the `neighbor` command in conjunction with the [passive-interface \(RIPng\)](#) command to send routing updates to specific neighbors.

Examples

```
awplus# configure terminal
awplus(config)# router ipv6 rip
awplus(config-router)# neighbor 2001:db8:1::1 vlan2

awplus# configure terminal
awplus(config)# router ipv6 rip
awplus(config-router)# no neighbor 2001:db8:1::1 vlan2
```

Related Commands [passive-interface \(RIPng\)](#)

offset-list (RIPng)

Use this command to add an offset to in and out metrics to routes learned through RIPng.

Use the **no** variant of this command to remove an offset list.

Syntax `offset-list {<access-list-number>|<access-list-name>} {in|out}
<offset> [<interface>]`

`no offset-list {<access-list-number>|<access-list-name>} {in|out}
<offset> [<interface>]`

Parameter	Description
<code><access-list-number></code>	Specify an access-list number to apply to an offset-list.
<code><access-list-name></code>	Specify and access-list name to apply to an offset-list.
<code>in</code>	Indicates the access-list will be used for metrics of incoming advertised routes
<code>out</code>	Indicates the access-list will be used for metrics of outgoing advertised routes
<code><offset></code>	<code><0-16></code> Specifies that the offset is used for metrics of networks matching the access-list
<code><interface></code>	The interface to match. For instance: ■ <code>vlan2</code>

Default The default offset value is the metric value of the interface over which the updates are being exchanged.

Mode Router Configuration

Usage Use this command to specify the offset value that is added to the routing metric. When the networks match the access list the offset is applied to the metrics. No change occurs if the offset value is zero.

Example In this example the router examines the RIPng updates being sent out from interface `vlan2` and adds 8 hops to the routes matching the ip addresses specified in the access list 2.

```
awplus# configure terminal
awplus(config)# router ipv6 rip
awplus(config-router)# offset-list mylist in 8 vlan2
```

passive-interface (RIPng)

Use this command to enable suppression of routing updates on an interface.

Use the **no** variant of this command to disable this function.

Syntax `passive-interface <interface>`
`no passive-interface <interface>`

Parameter	Description
<code><interface></code>	The interface. For instance: <ul style="list-style-type: none"> ■ <code>vlan2</code>

Default Disabled

Mode Router Configuration

Examples

```
awplus# configure terminal
awplus(config)# router ipv6 rip
awplus(config-router)# passive-interface vlan2

awplus# configure terminal
awplus(config)# router ipv6 rip
awplus(config-router)# no passive-interface vlan2
```

recv-buffer-size (RIPng)

Use this command to configure the RIPng UDP (User Datagram Protocol) receive-buffer size. This should improve UDP reliability by avoiding UDP receive buffer overruns.

Use the **no** variant of this command to unset the configured RIPng UDP receive-buffer size and set it back to the system default value of 196608 bits.

Syntax `recv-buffer-size <8192-2147483647>`
`no recv-buffer-size`

Default The RIPng UDP receive-buffer-size is 196608 bits by default, and is reset to the default using the **no** variant of this command.

Mode Router Configuration

Example

```
awplus# configure terminal
awplus(config)# router ipv6 rip
awplus(config-router)# recv-buffer-size 23456789
```

redistribute (RIPng)

Use this command to redistribute information from other routing protocols into RIPng.

Use the **no** variant of this command to disable the specified redistribution. The parameters **metric** and **route-map** may be used on this command, but have no effect.

Syntax

```
redistribute {connected|static} [metric <0-16>]
           [route-map <route-map>]

no redistribute {connected|static} [metric <0-16>]
           [route-map <route-map>]
```

Parameter	Description
<0-16>	Optional. Specifies the metric value to be used when redistributing information. If a value is not specified, and no value is specified using the default-metric (RIPng) command, the default value is zero.
<route-map>	Optional. Specifies route-map to be used to redistribute information.
connected	Redistribute from connected routes
static	Redistribute from static routes

Mode Router Configuration

Example

```
awplus# configure terminal
awplus(config)# router ipv6 rip
awplus(config-router)# redistribute static route-map mymap
awplus(config-router)# redistribute static metric 8
```

route (RIPng)

Use this command to configure static RIPng routes.

Use the **no** variant of this command to disable this function.

Syntax `route <ipv6-addr/prefix-length>`
`no route <ipv6-addr/prefix-length>`

Parameter	Description
<code><ipv6-addr/prefix-length></code>	Specify the IPv6 Address in format <code>X:X::X:X/Prefix-Length</code> . The prefix-length is a decimal integer between 1 and 128.

Mode Router Configuration

Usage Use this command to add a static RIPng route. After adding the RIPng route, the route can be checked in the RIPng routing table.

Example

```
awplus# configure terminal
awplus(config)# router ipv6 rip
awplus(config-router)# route 2001:db8::1/64
```

Related Commands `show ipv6 rip`
`clear ipv6 rip route`

router ipv6 rip

Use this global command to enter Router Configuration mode to enable a RIPng routing process.

Use the **no** variant of this command to disable the RIPng routing process.

Syntax `router ipv6 rip`
`no router ipv6 rip`

Mode Global Configuration

Example

```
awplus# configure terminal
awplus(config)# router ipv6 rip
awplus(config-router)#
```

show debugging ipv6 rip

Use this command to display the RIPng debugging status for the debugging options of: nsm debugging, RIPng event debugging, RIPng packet debugging, and RIPng nsm debugging.

For information on output options, see ["Controlling "show" Command Output" on page 1.35.](#)

Syntax `show debugging ipv6 rip`

Mode Privileged Exec

Usage Use this command to display the debug status of RIPng.

Example

```
awplus# show debugging ipv6 rip
```

show ipv6 protocols rip

Use this command to display RIPng process parameters and statistics.

For information on output options, see [“Controlling “show” Command Output” on page 1.35.](#)

Syntax `show ipv6 protocols rip`

Mode User Exec and Privileged Exec

Example

```
awplus# show ipv6 protocols rip
```

Output Figure 34-1: Example output from the `show ipv6 protocols rip` command

Codes: R - RIP, Rc - RIP connected, Rs - RIP static, Ra - RIP aggregated, Rcx - RIP connect suppressed, Rsx - RIP static suppressed, C - Connected, S - Static, O - OSPF, B - BGP

	Network	Next Hop	If	Met	Tag	Time
R	2001:db8:1::/48	2001:db8:2::/48	vlan3	3	0	02:28
C	2001:db8:3::/48	::	vlan2	1	0	
Ra	2001:db8:4::/48	--	--	1	0	
Rs	2001:db8:5::/48	2001:db8:1::/48	vlan3	3	0	02:32
Cs	2001:db8:6::/48	::	vlan3	1	0	

show ipv6 rip

Use this command to show RIPng routes.

For information on output options, see [“Controlling “show” Command Output”](#) on page 1.35.

Syntax `show ipv6 rip`

Mode User Exec and Privileged Exec

Example

```
awplus# show ipv6 rip
```

Output Figure 34-2: Example output from the `show ipv6 rip` command

```
Routing Protocol is "RIPng"
  Sending updates every 30 seconds with +/-50%, next due in 10
seconds
  Timeout after 180 seconds, garbage collect after 120 seconds
  Outgoing update filter list for all interface is not set
  Incoming update filter list for all interface is not set
  Default redistribute metric is 1
  Redistributing: connected
  Routing for Networks:
    2001:db8:1::/64

Codes: R - RIP, Rc - RIP connected, Rs - RIP static, Ra - RIP
aggregated, Rcx - RIP connect suppressed, Rsx - RIP static
suppressed, C - Connected, S - Static, O - OSPF, B - BGP

Network          Next Hop          If      Met Tag  Time
2001:db8::/64
```

Related Commands `show ipv6 rip database`

show ipv6 rip database

Use this command to display information about the RIPng database.

For information on output options, see [“Controlling “show” Command Output” on page 1.35.](#)

Syntax `show ipv6 rip database`

Mode User Exec and Privileged Exec

Example

```
awplus# show ipv6 rip database
```

Output Table 34-1: Example output from the `show ipv6 rip database` command

```
Codes: R - RIP, Rc - RIP connected, Rs - RIP static, Ra - RIP
aggregated, Rcx - RIP connect suppressed, Rsx - RIP static
suppressed, C - Connected, S - Static, O - OSPF, B - BGP
```

	Network	Next Hop	If	Met	Tag	Time
R	2001:db8:1::/48	2001:db8:2::/48	vlan3	3	0	02:28
C	2001:db8:3::/48	::	vlan2	1	0	
Ra	2001:db8:4::/48	--	--	1	0	
Rs	2001:db8:5::/48	2001:db8:1::/48	vlan3	3	0	02:32
Cs	2001:db8:6::/48	::	vlan3	1	0	

Related Commands `show ipv6 rip`

show ipv6 rip interface

Use this command to display information about the RIPng interfaces. You can specify an interface name to display information about a specific interface.

For information on output options, see [“Controlling “show” Command Output” on page 1.35.](#)

Syntax `show ipv6 rip interface [<interface>]`

Parameter	Description
<interface>	The interface to display information about. For instance: ■ vlan2

Mode User Exec and Privileged Exec

Example

```
awplus# show ipv6 rip interface
```

Output Figure 34-3: Example output from the `show ipv6 rip interface` command

```
lo is up, line protocol is up
RIPng is not enabled on this interface
vlan1 is up, line protocol is up
RIPng is not enabled on this interface
vlan2 is down, line protocol is down
RIPng is not enabled on this interface
vlan3 is up, line protocol is up
Routing Protocol: RIPng
Passive interface: Disabled
Split horizon: Enabled with Poisoned Reversed
IP interface address:
2001:db8:1::1/64
2001:db8:1::2/64
```

timers (RIPng)

Use this command to adjust the RIPng routing network timers.

Use the **no** variant of this command to restore the defaults.

Syntax `timers basic <update> <timeout> <garbage>`
`no timers basic`

Parameter	Description
<code><update></code>	<code><5-2147483647></code> Specifies the RIPng routing table update timer in seconds. The default is 30 seconds.
<code><timeout></code>	<code><5-2147483647></code> Specifies the RIPng routing information timeout timer in seconds. The default is 180 seconds. After this interval has elapsed and no updates for a route are received, the route is declared invalid.
<code><garbage></code>	<code><5-2147483647></code> Specifies the RIPng routing garbage collection timer in seconds. The default is 120 seconds.

Default The default RIPng routing table update timer default is 30 seconds, the default RIPng routing information timeout timer is 180 seconds, and the default RIPng routing garbage collection timer is 120 seconds. The **no** variant of this command restores the default RIPng routing timers.

Mode Router Configuration

Example

```
awplus# configure terminal
awplus(config)# router ipv6 rip
awplus(config-router)# timers basic 30 180 120
```

undebg ipv6 rip

Use this command to disable debugging options of RIPng events, RIPng packets, and communication between RIPng and NSM processes.

Syntax `undebg ipv6 rip [all|events|nsm|packet [recv|send][detail]]`

Parameter	Description
all	Disables all RIPng debugging.
events	Disable the display of RIPng events information.
nsm	Disable the display of RIPng and NSM communication.
packet	Disable debugging of specified RIPng packets only.
recv	Disable the display of information for received packets.
send	Disable the display of information for sent packets.
detail	Disable the display of detailed information for sent or received packets.

Mode Privileged Exec and Global Configuration

Example

```
awplus# undebg ipv6 rip events
```

```
awplus# undebg ipv6 rip all
```

```
awplus# undebg ipv6 rip packet send
```

```
awplus# undebg ipv6 rip packet recv detail
```

Related Commands [debug ipv6 rip](#)

Chapter 35: OSPF Configuration



Introduction.....	35.2
Terminology.....	35.2
Enabling OSPF on an Interface.....	35.3
Setting priority.....	35.5
Configuring an Area Border Router.....	35.7
Redistributing Routes Into OSPF.....	35.8
OSPF Cost.....	35.9
Configuring Virtual Links.....	35.12
OSPF Authentication.....	35.14

Introduction

This chapter contains basic OSPF configuration examples. To see details on the OSPF commands used in these examples, or to see the outputs of the validation commands, refer to [Chapter 36, OSPF Commands](#).

Terminology

The following is a brief description of terms and concepts used to describe the OSPF protocol:

OSPF Router

Any Layer 3 routing device that is running OSPF, such as an Allied Telesis managed layer 3 switch or Allied Telesis router.

Designated Router

Each OSPF network contains a designated router, that:

- originates the network link state advertisement for the network
- becomes adjacent to all other routers on the network

Since the topological database is spread over adjacencies, the designated router coordinates the synchronization of the topological database on all the routers attached to the network.

The designated router for a broadcast network is determined dynamically via hello packets. On non-broadcast multi-access networks, static configuration information is used to initiate the search for a designated router. To help in dynamic failover, OSPF also determines a backup designated router for a network via hello packets. The backup designated router, like the designated router maintains an adjacency to all other routers on the network. If the designated router fails for any reason, the backup designated router takes over.

Autonomous System

A set of routers that exchange OSPF routing information with each other.

Router ID

A unique ID assigned to each OSPF router. This ID takes the same form as an IP address, i.e. A.B.C.D, where each of A, B, C, D is a number between 0 and 254. This number uniquely identifies the OSPF router within the AS.

Adjacency

A relationship created between neighboring OSPF routers, for the purpose of exchanging topological information. Not every router needs to become adjacent to every other router. Adjacencies are established and maintained with *hello* packets. These packets are sent periodically on all router interfaces. Bidirectional communication is determined by a router seeing itself listed in hello packets from its neighbors.

Enabling OSPF on an Interface

This example shows the minimum configuration required for enabling OSPF on an interface. In this example, the OSPF routers are Allied Telesis managed Layer 3 switches. `Switch 1` and `Switch 2` are two OSPF routers in `Area 0` connecting to network `10.10.10.0/24`.

Note  Configure one interface so that it belongs to only one area. However, you can configure different interfaces on an OSPF router to belong to different areas.

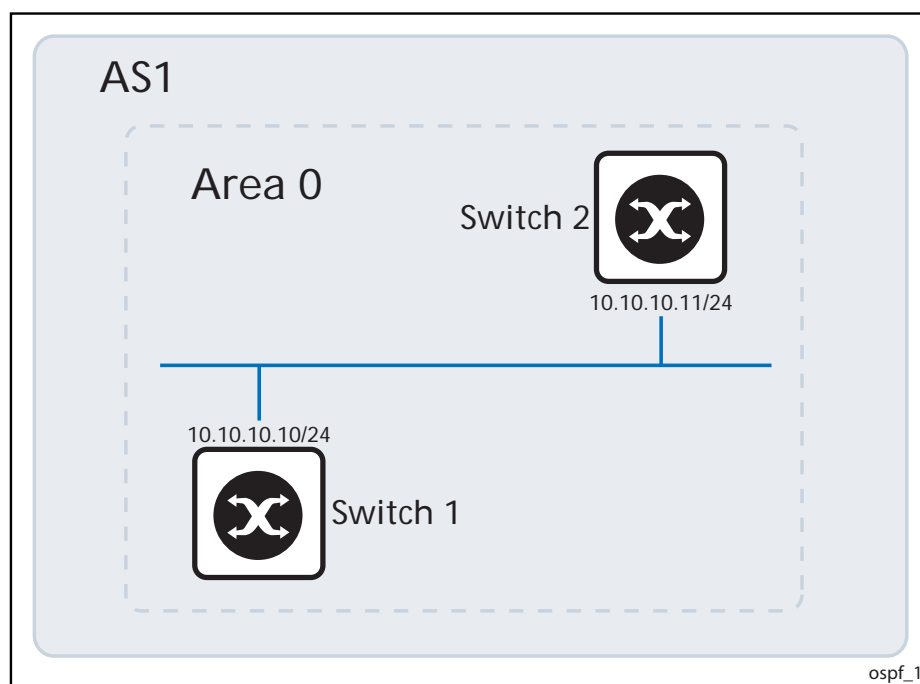

Switch 1

```
awplus#
configure terminal  Enter the Global Configuration mode.
-----
awplus(config)#
router ospf 100  Configure the Routing process and specify the
                  Process ID (100). The Process ID should be a
                  unique positive integer identifying the routing
                  process.
-----
awplus(config-router)#
network 10.10.10.0/24 area 0  Define the interface (10.10.10.0/24) on
                              which OSPF runs and associate the area ID (0)
                              with the interface (area ID 0 specifies the
                              backbone area).
```

Switch 2

<pre>awplus# configure terminal</pre>	Enter the Global Configuration mode
<pre>awplus(config)# router ospf 200</pre>	Configure the Routing process and specify the Process ID (200). The Process ID should be a unique positive integer identifying the routing process. Note that the process ID used on this switch is different to that used on Switch 1. This is correct configuration as the process ID is a value that is only used within a single OSPF router. Therefore there is no requirement for the process IDs used on one OSPF router to have any relationship with the process IDs used on the other OSPF routers that it interacts with.
<pre>awplus(config-router)# network 10.10.10.0/24 area 0</pre>	Define the interface (10.10.10.0/24) on which OSPF runs and associate the area ID (0) with the interface.

Names of Commands Used

network area
router ospf

Validation Commands

show ip ospf
show ip ospf interface
show ip ospf neighbor
show ip ospf route

Setting priority

This example shows the configuration for setting the priority for an interface. You can set a high priority for an OSPF router to make it the Designated Router (DR). In this example, the OSPF routers are Allied Telesis managed Layer 3 switches. Switch 3 is configured to have a priority of 10, which is higher than the default priority (default priority is 1) of Switch 1 and Switch 2; making it the DR. In this example network the back-up DR would be Switch 2 as it has a higher router ID than Switch 1.

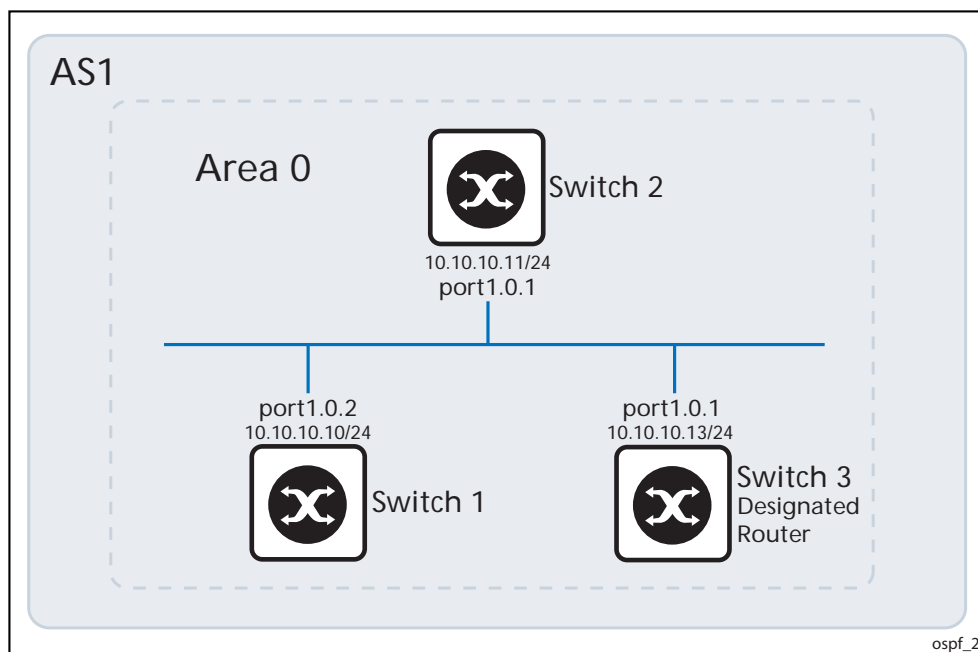

Switch 3

<code>awplus(config)#</code>	
<code>interface vlan2</code>	Specify the interface (vlan2) to be configured.
<code>awplus(config-if)#</code>	
<code>ip ospf priority 10</code>	Specify the router priority to a higher priority (10) to make Switch 3 the Designated Router (DR).
<code>awplus(config-if)#</code>	
<code>exit</code>	Exit the Interface Configuration mode and return to the Global Configuration mode.
<code>awplus(config)#</code>	
<code>router ospf 100</code>	Configure the Routing process and specify the Process ID (100). The Process ID should be a unique positive integer identifying the routing process.
<code>awplus(config-router)#</code>	
<code>network 10.10.10.0/24 area 0</code>	Define the interface (10.10.10.0/24) on which OSPF runs and associate the area ID (0) with the interface.

Switch 1

```

awplus#
configure terminal  Enter the Global Configuration mode.

```

```

awplus(config)#
router ospf 100  Configure the Routing process and specify the
                  Process ID (100). The Process ID should be a
                  unique positive integer identifying the routing
                  process.

```

```

awplus(config-router)#
network 10.10.10.0/24 area 0  Define the interface (10.10.10.0/24) on
                              which OSPF runs and associate the area ID (0)
                              with the interface (area ID 0 specifies the backbone
                              area).

```

Switch 2

```

awplus#
configure terminal  Enter the Global Configuration mode.

```

```

awplus(config)#
router ospf 200  Configure the Routing process and specify the
                 Process ID (200). The Process ID should be a
                 unique positive integer identifying the routing
                 process.

```

```

awplus(config-router)#
network 10.10.10.0/24 area 0  Define the interface (10.10.10.0/24) on
                              which OSPF runs and associate the area ID (0)
                              with the interface.

```

Names of Commands Used

network area
ip ospf priority

Validation Commands

show ip ospf neighbor
show ip ospf interface

Configuring an Area Border Router

This example shows configuration for an Area Border Router (ABR). In this example, the OSPF routers are Allied Telesis managed Layer 3 switches. `Switch 2` is an ABR, where interface `vlan2` is in `Area 0` and interface `vlan3` is in `Area 1`.

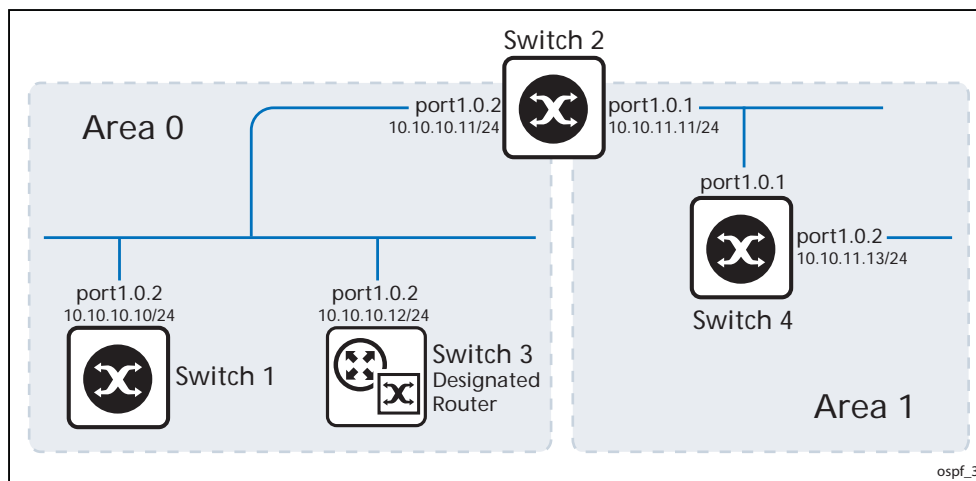

Switch 2

<code>awplus#</code>	
<code>configure terminal</code>	Enter the Global Configuration mode.
<code>awplus(config)#</code>	
<code>router ospf 100</code>	Configure the Routing process and specify the Process ID (100). The Process ID should be a unique positive integer identifying the routing process.
<code>awplus(config-router)#</code>	
<code>network 10.10.10.0/24 area 0</code>	Define one interface (10.10.10.0/24) on which OSPF runs and associate the area ID (0) with the interface.
<code>awplus(config-router)#</code>	
<code>network 10.10.11.0/24 area 1</code>	Define the other interface (10.10.11.0/24) on which OSPF runs and associate the area ID (1) with the interface.

Names of Commands Used

`network area`

Validation Commands

`show ip ospf`
`show ip ospf interface`

Redistributing Routes Into OSPF

In this example the configuration causes BGP routes to be imported into the OSPF routing table and advertised as **Type 5** External LSAs into **Area 0**. In this example, the OSPF routers, labelled "Device 1-5" represent any Allied Telesis managed Layer 3 switches or Allied Telesis routers.

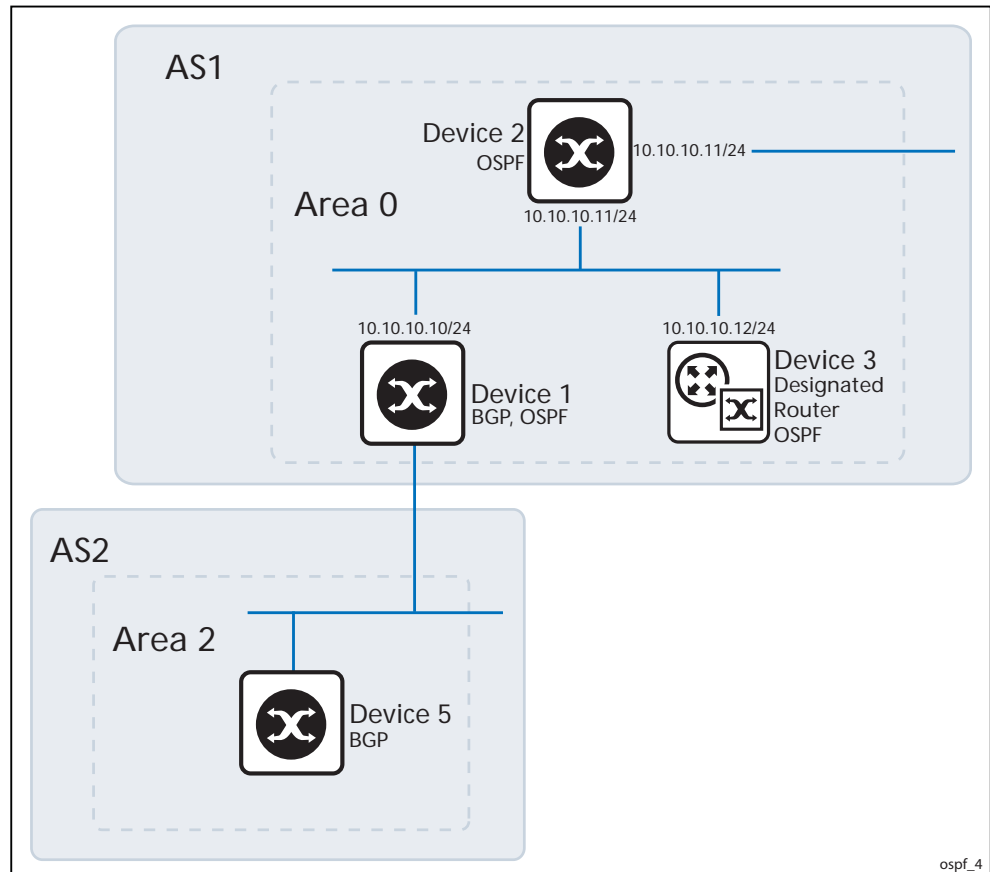

Device 1

<code>awplus#</code>	
<code>configure terminal</code>	Enter the Global Configuration mode.
<code>awplus(config)#</code>	
<code>router ospf 100</code>	Configure the Routing process and specify the Process ID (100). The Process ID should be a unique positive integer identifying the routing process.
<code>awplus(config-router)#</code>	
<code>network 10.10.10.0/24 area 0</code>	Define one interface (10.10.10.0/24) on which OSPF runs and associate the area ID (0) with the interface (area ID 0 specifies the backbone area).
<code>awplus(config-router)#</code>	
<code>redistribute bgp</code>	Specify redistributing routes from other routing protocol (BGP) into OSPF.

Names of Commands Used

```
redistribute (OSPF)
network area
```

Validation Commands

```
show ip ospf database external
```

OSPF Cost

You can make a route the preferred route by changing its cost. In this example, the OSPF routers are Allied Telesis managed Layer 3 switches. The cost has been configured to make `Switch 2` the next hop for `Switch 1`.

The default cost on each interface is 10. Interface `vlan2` on `Switch 2` has a cost of 100 and interface `vlan3` on `Switch 3` has a cost of 150. The total cost for `Switch 1` to reach `10.10.14.0/24` (`Switch 4`) `Switch 2` or via `Switch 3` is:

Switch 2: $10+100 = 110$

Switch 3: $10+150 = 160$

Therefore, `Switch 1` chooses `Switch 2` as its next hop for destination `10.10.14.0/24`, as that path has the lower cost.

Switch 1

```
awplus#
configure terminal Enter the Global Configuration mode.
awplus(config)#
router ospf 100 Configure the Routing process and specify the
Process ID (100). The Process ID should be a
unique positive integer identifying the routing
process.
awplus(config-router)#
network 10.10.9.0/24 area 0 Define interfaces on which OSPF runs and
awplus(config-router)# associate the area ID (0) with the interface
network 10.10.10.0/24 area 0 (area ID 0 specifies the backbone area).
awplus(config-router)#
network 10.10.12.0/24 area 0
```

Switch 2

```

awplus#
configure terminal Enter the Global Configuration mode.
awplus(config)#
interface vlan2 Specify the interface (vlan2) to be configured.
awplus(config-if)#
ip ospf cost 100 Set the OSPF cost of this link to 100.
awplus(config-if)#
exit Exit the Interface Configuration mode and
return to the Global Configuration mode.
awplus(config)#
router ospf 100 Configure the Routing process and specify the
Process ID (100). The Process ID should be a
unique positive integer identifying the routing
process.
awplus(config-router)#
network 10.10.10.0/24 area 0 Define interfaces on which OSPF runs and
associate the area ID (0) with the interface.
awplus(config-router)#
network 10.10.11.0/24 area 0 Define interfaces on which OSPF runs and
associate the area ID (0) with the interface.

```

Switch 3

```

awplus(config)#
interface vlan3 Specify the interface (vlan3) to be configured.
awplus(config-if)#
ip ospf cost 150 Set the OSPF cost of this link to 100.
awplus(config-if)#
exit Exit the Interface Configuration mode and
return to the Global Configuration mode.
awplus(config)#
router ospf 100 Configure the Routing process and specify the
Process ID (100). The Process ID should be a
unique positive integer identifying the routing
process.
awplus(config-router)#
network 10.10.12.0/24 area 0 Define interfaces on which OSPF runs and
associate the area ID (0) with the interface.
awplus(config-router)#
network 10.10.13.0/24 area 0

```

Switch 4

```
awplus(config)#
router ospf 100  Configure the Routing process and specify the
                  Process ID (100). The Process ID should be a
                  unique positive integer identifying the routing
                  process.
awplus(config-router)#
network 10.10.11.0/24 area 0  Define interfaces on which OSPF runs and
awplus(config-router)#      associate the area ID (0) with the interface.
network 10.10.13.0/24 area 0
awplus(config-router)#
network 10.10.14.0/24 area 0
```

Names of Commands Used

network area
ip ospf cost

Validation Commands

show ip ospf route

Configuring Virtual Links

Virtual links are used to connect a disjointed non-backbone area to the backbone area, or to repair a non-contiguous backbone area. In this example, the OSPF routers shown represent any Allied Telesis managed Layer 3 switches or Allied Telesis routers.

In the network below, there is no area border router that connects Area2 to the backbone. So a virtual link needs to be created between ABR Device 1 and ABR Device 2 to connect Area 2 to Area 0. Area 1 is used as a transit area.

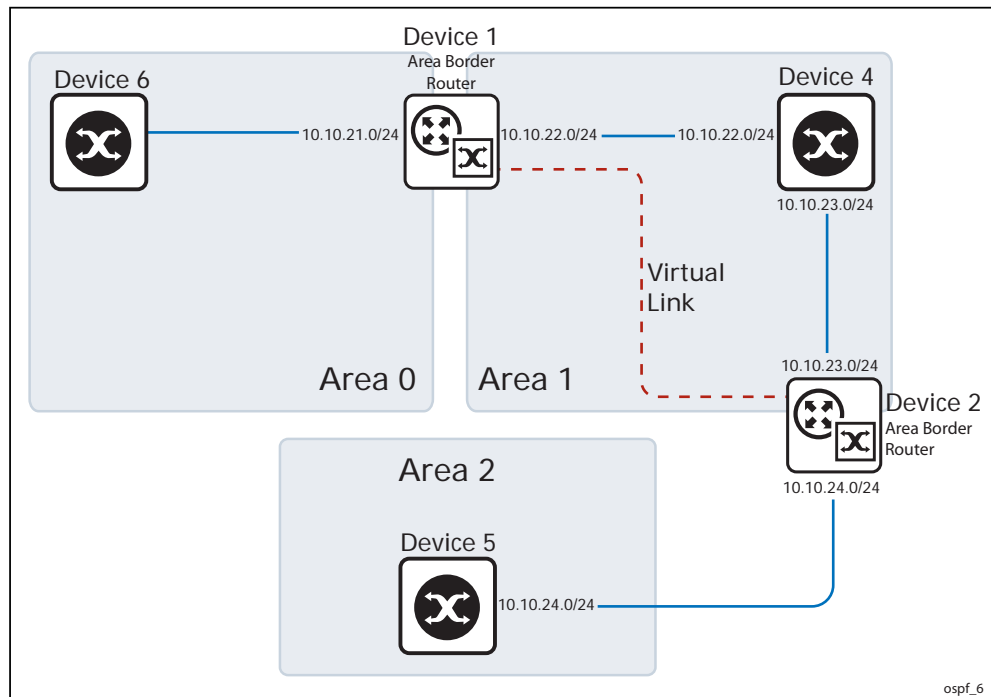

Device 1

```

awplus#
configure terminal  Enter the Global Configuration mode.
-----
awplus(config)#
router ospf 100  Configure the Routing process and specify
                  the Process ID (100). The Process ID
                  should be a unique positive integer
                  identifying the routing process.
-----
awplus(config-router)#
ospf router-id 10.10.21.1  Configure OSPF Router ID (10.10.21.1)
                           for this router.
-----
awplus(config-router)#
network 10.10.21.0/24 area 0  Define interfaces on which OSPF runs and
awplus(config-router)#      associate the area IDs (0 and 1) with the
network 10.10.22.0/24 area 1  interface.
-----
awplus(config-router)#
area 1 virtual-link 10.10.23.2  Configure a virtual link between Device 1
                                and Device 2 (10.10.23.2) through
                                transit area 1.

```

Device 2

<code>awplus(config)#</code>	
<code>router ospf 100</code>	Configure the Routing process and specify the Process ID (100). The Process ID should be a unique positive integer identifying the routing process.

<code>awplus(config-router)#</code>	
<code>ospf router-id 10.10.23.2</code>	Configure OSPF Router ID (10.10.23.2) for this router.

<code>awplus(config-router)#</code>	
<code>network 10.10.23.0/24 area 1</code>	Define interfaces on which OSPF runs and associate the area IDs (1 and 2) with the interface.
<code>awplus(config-router)#</code>	
<code>network 10.10.24.0/24 area 2</code>	

<code>awplus(config-router)#</code>	
<code>area 1 virtual-link 10.10.21.1</code>	Configure a virtual link between Device 2 and Device 1 (10.10.21.1) through transit area 1.

Names of Commands Used

area virtual-link
network area

Validation Commands

show ip ospf virtual-links
show ip ospf neighbor
show ip ospf
show ip ospf route

OSPF Authentication

In the AlliedWare Plus™ implementation there are three types of OSPF authentications--Null authentication (Type 0), Simple Text (Type 1) authentication and MD5 (Type 2) authentication. With null authentication, routing exchanges over the network are not authenticated. In Simple Text authentication, the authentication type is the same for all OSPF routers that communicate using OSPF in a network. For MD5 authentication, you configure a key and a key-id on each OSPF router. The OSPF router generates a message digest on the basis of the key, key ID and the OSPF packet and adds it to the OSPF packet.

The Authentication type can be configured on a per-interface basis or a per-area basis. Additionally, Interface and Area authentication can be used together. Area authentication is used for an area and interface authentication is used for a specific interface in the area. If the Interface authentication type is different from Area authentication type, Interface authentication type overrides the Area authentication type. If the Authentication type is not specified for an interface, the Authentication type for the area is used. The authentication command descriptions contain details of each type of authentication. Refer to [Chapter 36, OSPF Commands](#) for OSPF authentication commands.

In this example, the OSPF routers are Allied Telesis managed Layer 3 switches. `Switch 1` and `Switch 2` are configured for both the interface and area authentications. The authentication type of interface `vlan2` on `Switch 1` and interface `vlan2` on `Switch 2` is md5 mode and is defined by the [area authentication command on page 36.3](#); however, the authentication type of interface `vlan3` on `Switch 1` and interface `vlan4` on `Switch 2` is plain text mode and is defined by the `ip ospf authentication` command. This interface command overrides the area authentication command.

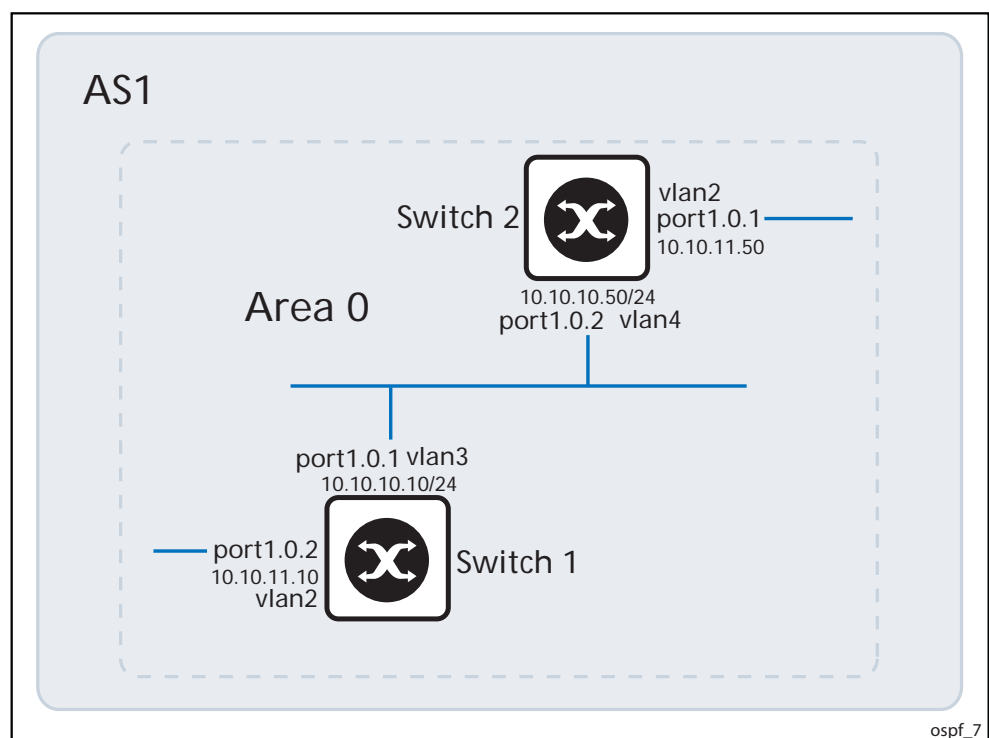

Switch 1

<code>awplus#</code>	
<code>configure terminal</code>	Enter the Global Configuration mode.
<code>awplus(config)#</code>	
<code>router ospf 100</code>	Configure the Routing process and specify the Process ID (100). The Process ID should be a unique positive integer identifying the routing process.
<code>awplus(config-router)#</code>	
<code>network 10.10.10.0/24 area 0</code>	Define interfaces on which OSPF runs and associate the area ID (0) with the interface (area ID 0 specifies the backbone area).
<code>awplus(config-router)#</code>	
<code>network 10.10.11.0/24 area 0</code>	
<code>awplus(config-router)#</code>	
<code>area 0 authentication message-digest</code>	Enable MD5 authentication on area 0.
<code>awplus(config-router)#</code>	
<code>exit</code>	Exit the Router Configuration mode and return to the Global Configuration mode.
<code>awplus(config)#</code>	
<code>interface vlan2</code>	Specify the interface (<code>vlan2</code>) you are configuring.
<code>awplus(config-if)#</code>	
<code>ip ospf message-digest-key 1 md5 test</code>	Register MD5 key <code>test</code> for OSPF authentication. The Key ID is 1.
<code>awplus(config-if)#</code>	
<code>exit</code>	Exit the Interface Configuration mode and return to Global Configuration mode
<code>awplus(config)#</code>	
<code>interface vlan3</code>	Specify the interface (<code>vlan3</code>) you are configuring.
<code>awplus(config-if)#</code>	
<code>ip ospf authentication</code>	Enable OSPF packet to use text authentication on the current interface (<code>vlan3</code>).
<code>awplus(config-if)#</code>	
<code>ip ospf authentication-key test</code>	Specify an OSPF authentication password <code>test</code> for the neighboring OSPF routers.

Switch 2

<code>awplus#</code>	
<code>configure terminal</code>	Enter the Global Configuration mode.
<code>awplus(config)#</code>	
<code>router ospf 100</code>	Configure the Routing process and specify the Process ID (100). The Process ID should be a unique positive integer identifying the routing process.
<code>awplus(config-router)#</code>	
<code>network 10.10.10.0/24 area 0</code>	Define interfaces on which OSPF runs and associate the area ID (0) with the interface (area ID 0 specifies the backbone area).
<code>awplus(config-router)#</code>	
<code>network 10.10.11.0/24 area 0</code>	
<code>awplus(config-router)#</code>	
<code>area 0 authentication message-digest</code>	Enable MD5 authentication on area 0.
<code>awplus(config-router)#</code>	
<code>exit</code>	Exit the Router Configuration mode and return to the Global Configuration mode.
<code>awplus(config)#</code>	
<code>interface vlan2</code>	Specify the interface (vlan2) you are configuring.
<code>awplus(config-if)#</code>	
<code>ip ospf message-digest-key 1 md5 test</code>	Register MD5 key test for OSPF authentication. The Key ID is 1.
<code>awplus(config-if)#</code>	
<code>exit</code>	Exit the Interface Configuration mode and return to Global Configuration mode
<code>awplus(config)#</code>	
<code>interface vlan4</code>	Specify the interface (vlan4) you are configuring.
<code>awplus(config-if)#</code>	
<code>ip ospf authentication</code>	Enable OSPF packet to use text authentication on the current interface (vlan4).
<code>awplus(config-if)#</code>	
<code>ip ospf authentication-key test</code>	Specify an OSPF authentication password test for the neighboring OSPF routers.

Names of Commands Used

`ip ospf authentication`
`ip ospf authentication-key`
`network area`
`area authentication`

Validation Commands

`show running-config`
`show ip ospf neighbor`

Chapter 36: OSPF Commands



Command List	36.3
area authentication.....	36.3
area default-cost	36.4
area filter-list.....	36.5
area nssa.....	36.6
area range.....	36.8
area stub.....	36.9
area virtual-link.....	36.10
auto-cost reference bandwidth	36.12
bandwidth.....	36.13
capability opaque	36.14
capability restart.....	36.15
clear ip ospf process.....	36.15
compatible rfc1583.....	36.16
debug ospf events	36.17
debug ospf ifsm	36.18
debug ospf lsa	36.19
debug ospf n fsm	36.20
debug ospf nsm.....	36.21
debug ospf packet	36.22
debug ospf route.....	36.23
default-information originate (OSPF)	36.24
default-metric (OSPF)	36.25
distance (OSPF)	36.26
distribute-list (OSPF).....	36.28
enable db-summary-opt.....	36.29
host area	36.30
ip ospf authentication	36.31
ip ospf authentication-key	36.32
ip ospf cost	36.33
ip ospf database-filter.....	36.34
ip ospf dead-interval.....	36.35
ip ospf disable all	36.36
ip ospf hello-interval	36.37
ip ospf message-digest-key	36.38
ip ospf mtu.....	36.39
ip ospf mtu-ignore.....	36.40
ip ospf network.....	36.41
ip ospf priority.....	36.42
ip ospf resync-timeout	36.43
ip ospf retransmit-interval	36.44
ip ospf transmit-delay	36.45
max-concurrent-dd.....	36.46
maximum-area.....	36.47
neighbor (OSPF)	36.48
network area	36.49
ospf abr-type	36.50

ospf restart grace-period.....	36.51
ospf restart helper.....	36.52
ospf router-id.....	36.53
overflow database.....	36.54
overflow database external.....	36.55
passive-interface (OSPF).....	36.56
redistribute (OSPF).....	36.57
restart ospf graceful.....	36.58
router ospf.....	36.59
router-id.....	36.60
show debugging ospf.....	36.60
show ip ospf.....	36.61
show ip ospf border-routers.....	36.63
show ip ospf database.....	36.64
show ip ospf database asbr-summary.....	36.65
show ip ospf database external.....	36.66
show ip ospf database network.....	36.67
show ip ospf database nssa-external.....	36.69
show ip ospf database opaque-area.....	36.71
show ip ospf database opaque-as.....	36.72
show ip ospf database opaque-link.....	36.73
show ip ospf database router.....	36.74
show ip ospf database summary.....	36.76
show ip ospf interface.....	36.78
show ip ospf neighbor.....	36.79
show ip ospf route.....	36.81
show ip ospf virtual-links.....	36.82
show ip protocols ospf.....	36.83
summary-address.....	36.84
timers spf.....	36.85
timers spf exp.....	36.86
undebug ospf events.....	36.87
undebug ospf ifsm.....	36.87
undebug ospf lsa.....	36.87
undebug ospf n fsm.....	36.87
undebug ospf nsm.....	36.87
undebug ospf packet.....	36.87
undebug ospf route.....	36.87

Command List

This chapter provides an alphabetical reference of commands used to configure OSPF. For more information, see [Chapter 35, OSPF Configuration](#).

area authentication

Use this command to enable authentication for an OSPF area. Specifying the area authentication sets the authentication to Type 1 authentication or the Simple Text password authentication (details in RFC 2328).

The **no** variant of this command removes the authentication specification for an area.

Syntax `area <area-id> authentication [message-digest]`
`no area <area-id> authentication`

Parameter	Description
<code><area-id></code>	The OSPF area that you are enabling authentication for. This can be entered in either dotted decimal format or normal decimal format.
<code><ip-addr></code>	OSPF Area ID expressed in IPv4 address, entered in the form A.B.C.D.
<code><0-4294967295></code>	OSPF Area ID expressed as a decimal number within the range shown.
	For example the values dotted decimal 0.0.1.2 and decimal 258 would both define the same area OSPF Area ID.
<code>message-digest</code>	Enables MD5 authentication in the OSPF area.

Default By default, no authentication occurs.

Mode Router Configuration

Usage All OSPF packets transmitted in this **area** must have the same password in their OSPF header. This ensures that only routers that have the correct password may join the routing domain.

Give all routers that are to communicate with each other through OSPF the same authentication password.

Use the [ip ospf authentication-key](#) command to specify a Simple Text password. Use the [ip ospf message-digest-key](#) command to specify MD5 password.

Example

```
awplus# configure terminal
awplus(config)# router ospf 100
awplus(config-router)# area 1 authentication
```

Related Commands [ip ospf authentication](#)
[ip ospf message-digest-key](#)

area default-cost

This command specifies a cost for the default summary route sent into a stub or NSSA area.

The **no** variant of this command removes the assigned default-route cost.

Syntax `area <area-id> default-cost <0-16777215>`
`no area <area-id> default-cost`

Parameter	Description
<area-id>	The OSPF area that you are specifying the default summary route cost for. Use one of the following formats: This can be entered in either dotted decimal format or normal decimal format.
<ip-addr>	OSPF Area ID expressed in IPv4 address format A.B.C.D.
<0-4294967295>	OSPF Area ID expressed as a decimal number within the range shown
	For example the values dotted decimal 0.0.1.2 and decimal 258 would both define the same area ID.
default-cost	Indicates the cost for the default summary route used for a stub or NSSA area. Default: 1

Mode Router Configuration

Usage The default-cost option provides the metric for the summary default route, generated by the area border router, into the NSSA or stub area. Use this option only on an area border router that is attached to the NSSA or stub area. Refer to the RFC 3101 for information on NSSA.

Example To set the default cost to 10 in area 1 for the OSPF instance 100, use the commands:

```
awplus# configure terminal
awplus(config)# router ospf 100
awplus(config-router)# area 1 default-cost 10
```

Related Commands `area nssa`
`area stub`

area filter-list

This command configures filters to advertise summary routes on Area Border Routers (ABR).

This command is used to suppress particular intra-area routes from/to an area to/from the other areas. You can use this command in conjunction with either the access-list or prefix-list command.

The **no** variant of this command removes the filter configuration.

Syntax `area <area-id> filter-list {access <access-list>|prefix <prefix-list>} {in|out}`

Parameter	Description
<area-id>	The OSPF area that you are configuring the filter for. Use one of the following formats: This can be entered in either dotted decimal format or normal decimal format.
<ip-addr>	OSPF Area ID expressed in IPv4 address format A.B.C.D.
<0-4294967295>	OSPF Area ID expressed as a decimal number within the range shown
	For example the values dotted decimal 0.0.1.2 and decimal 258 would both define the same area ID.
access	Use access-list to filter summary.
prefix	Use prefix-list to filter summary.
<access-list>	Name of an access-list.
<prefix-list>	Name of a prefix-list.
in	Filter routes from the other areas to this area.
out	Filter routes from this area to the other areas.

Mode Router Configuration

Example

```
awplus# configure terminal
awplus(config)# access-list 1 deny 172.22.0.0
awplus(config)# router ospf 100
awplus(config-router)# area 1 filter-list access 1 in
```

area nssa

This command sets an area as a Not-So-Stubby-Area (NSSA). By default, no NSSA area is defined.

Use this command to simplify administration if you are connecting a central site using OSPF to a remote site that is using a different routing protocol. You can extend OSPF to cover the remote connection by defining the area between the central router and the remote router as an NSSA.

There are no external routes in an OSPF stub area, so you cannot redistribute from another protocol into a stub area. A NSSA allows external routes to be flooded within the area. These routes are then leaked into other areas. Although, the external routes from other areas still do not enter the NSSA. You can either configure an area to be a stub area or an NSSA, not both.

The **no** variant of this command removes this designation.

Syntax

```
area <area-id> nssa [default-information-originate <metric> |
  no-redistribution | no-summary | translator-role <role> ]
no area <area-id> nssa [default-information-originate |
  no-redistribution | no-summary | translator-role ]
```

Parameter	Description
<area-id>	The OSPF area that you are configuring as an NSSA. Use one of the following formats: This can be entered in either dotted decimal format or normal decimal format.
<ip-addr>	OSPF Area ID expressed in IPv4 address format A.B.C.D.
<0-4294967295>	OSPF Area ID expressed as a decimal number within the range shown
	For example the values dotted decimal 0.0.1.2 and decimal 258 would both define the same area ID.
default-information-originate	Originate Type-7 default LSA into NSSA.
<metric>	The external or internal metric. Specify the following:
metric	The metric value.
<0-16777214>	
metric-type	External metric type.
<1-2>	
no-redistribution	Do not redistribute external route into NSSA.
no-summary	Do not inject inter-area route into NSSA.
translator-role	Specify NSSA-ABR translator-role.

Parameter (cont.)	Description (cont.)
<code><role></code>	The role type. Specify one of the following keywords:
<code>always</code>	Router always translate NSSA-LSA to Type-5 LSA.
<code>candidate</code>	Router may translate NSSA-LSA to Type-5 LSA if it is elected.
<code>never</code>	Router never translate NSSA-LSA.

Mode Router Configuration

Example

```

awplus# configure terminal
awplus(config)# router ospf 100
awplus(config-router)# area 0.0.0.51 nssa
awplus(config-router)# area 3 nssa translator-role candidate
no-redistribution default-information-originate metric 34 metric-type 2
    
```

Related Commands [area default-cost](#)

area range

This command summarizes OSPF routes at an area boundary. By default, this feature is disabled.

The area range command is used to summarize intra-area routes for an area. The set of summary routes created by this command are then advertised to other areas by the Area Border Routers (ABRs). In this way, routing information is condensed at area boundaries so that routes are exchanged between areas in an efficient manner.

If the network numbers in an area are assigned in a way such that they fall into sets of contiguous routes, the ABRs can be configured to advertise a small set of summary routes that cover the individual networks within the area.

The **no** variant of this command disables this function.

Syntax `area <area-id> range <ip-addr/prefix-length> [advertise|not-
advertise]`

`no area <area-id> range <ip-addr/prefix-length>`

Parameter	Description
<code><area-id></code>	The OSPF area that you summarizing the routes for. Use one of the following formats: This can be entered in either dotted decimal format or normal decimal format.
<code><ip-addr></code>	OSPF Area ID expressed in IPv4 address format A.B.C.D.
<code><0-4294967295></code>	OSPF Area ID expressed as a decimal number within the range shown
	For example the values dotted decimal 0.0.1.2 and decimal 258 would both define the same area ID.
<code><ip-addr/ prefix-length></code>	The area range prefix and length.
<code>advertise</code>	Advertise this range as a summary route into other areas.
<code>not-advertise</code>	Does not advertise this range.

Mode Router Configuration

Usage Multiple ranges can be configured on a single area by multiple instances of this command.

Example

```
awplus# configure terminal
awplus(config)# router ospf 100
awplus(config-router)# area 1 range 192.16.0.0/16
awplus(config-router)# area 1 range 203.18.0.0/16
```

area stub

This command defines an OSPF area as a stub area. By default, no stub area is defined.

Use this command when routers in the area do not require learning about summary LSAs from other areas. You can define the area as a totally stubby area by configuring the Area Border Router of that area using the **area stub no-summary** command.

There are two stub area router configuration commands: the **area stub** and **area default-cost** commands. In all routers attached to the stub area, configure the area by using the **area stub** command. For an area border router (ABR) attached to the stub area, also use the **area default-cost** command.

The **no** variant of this command removes this definition.

Syntax

```
area <area-id> stub [no-summary]
no area <area-id> stub [no-summary]
```

Parameter	Description
<area-id>	The OSPF area that you are configuring as a stub area. Use one of the following formats: This can be entered in either dotted decimal format or normal decimal format. For example the values dotted decimal 0.0.1.2 and decimal 258 would both define the same area ID.
<ip-addr>	OSPF Area ID expressed in IPv4 address in the format A.B.C.D.
<0-4294967295>	OSPF Area ID expressed as a decimal number within the range shown
	For example the values dotted decimal 0.0.1.2 and decimal 258 would both define the same area ID.
no-summary	Stops an ABR from sending summary link advertisements into the stub area.

Mode Router Configuration

Example

```
awplus# configure terminal
awplus(config)# router ospf 100
awplus(config-router)# area 1 stub
```

Related Commands [area default-cost](#)

area virtual-link

This command configures a link between two backbone areas that are physically separated through other non-backbone areas.

In OSPF, all non-backbone areas must be connected to a backbone area. If the connection to the backbone is lost, the virtual link repairs the connection.

The **no** variant of this command removes the virtual link.

Syntax

```

area <area-id> virtual-link <ip-addr> [<auth-key>|<msg-key>]
no area <area-id> virtual-link <ip-addr> [<auth-key>|<msg-key>]

area <area-id> virtual-link <ip-addr> authentication
    [message-digest|null] [<auth-key>|<msg-key>]
no area <area-id> virtual-link <ip-addr> authentication
    [message-digest|null] [<auth-key>|<msg-key>]

area <area-id> virtual-link <ip-addr> [authentication]
    [dead-interval <1-65535>] [hello-interval <1-65535>]
    [retransmit-interval <1-3600>] [transmit-delay <1-3600>]
no area <area-id> virtual-link <ip-addr> [authentication]
    [dead-interval] [hello-interval] [retransmit-interval] [transmit-
    delay]
  
```

Parameter	Description
<area-id>	The area ID of the transit area that the virtual link passes through. Use one of the following formats: This can be entered in either dotted decimal format or normal decimal format.
<ip-addr>	OSPF Area ID expressed in IPv4 address format A.B.C.D.
<0-4294967295>	OSPF Area ID expressed as a decimal number within the range shown
	For example the values dotted decimal 0.0.1.2 and decimal 258 would both define the same area ID.
<ip-address>	The OSPF router ID of the virtual link neighbor.
<auth-key>	Specifies the password used for this virtual link. Use the following format: authentication-key <pswd-short>
	<pswd-short> An 8 character password.
<msg-key>	Specifies a message digest key using the MD5 encryption algorithm. Use the following format: message-digest-key <1-255> md5 <pswd-long>
	<1-255> The key ID.
	<pswd-long> Authentication password of 16 characters.
authentication	Enables authentication on this virtual link.
message-digest	Use message-digest authentication.

Parameter (cont.)	Description (cont.)
<code>null</code>	Use null authentication to override password or message digest.
<code>dead-interval</code>	If no packets are received from a particular neighbor for <code>dead-interval</code> seconds, the router considers that neighboring router as being off-line. Default: 40 seconds
	<code><1-65535></code> The number of seconds in the interval.
<code>hello-interval</code>	The interval the router waits before it sends a hello packet. Default: 10 seconds
	<code><1-65535></code> The number of seconds in the interval.
<code>retransmit-interval</code>	The interval the router waits before it retransmits a packet. Default: 5 seconds
	<code><1-3600></code> The number of seconds in the interval.
<code>transmit-delay</code>	The interval the router waits before it transmits a packet. Default: 1 seconds
	<code><1-3600></code> The number of seconds in the interval.

Mode Router Configuration

Usage You can configure virtual links between any two backbone routers that have an interface to a common non-backbone area. The protocol treats these two routers, joined by a virtual link, as if they were connected by an unnumbered point-to-point network. To configure a virtual link, you require:

- The transit area ID, i.e. the area ID of the non backbone area that the two backbone routers are both connected to.
- The corresponding virtual link neighbor's router ID. To see the router ID use the `show ip ospf` command.

Configure the **hello-interval** to be the same for all routers attached to a common network. A short **hello-interval** results in the router detecting topological changes faster but also an increase in the routing traffic.

The **retransmit-interval** is the expected round-trip delay between any two routers in a network. Set the value to be greater than the expected round-trip delay to avoid needless retransmissions.

The **transmit-delay** is the time taken to transmit a link state update packet on the interface. Before transmission, the link state advertisements in the update packet, are incremented by this amount. Set the **transmit-delay** to be greater than zero. Also, take into account the transmission and propagation delays for the interface.

Example

```
awplus# configure terminal
awplus(config)# router ospf 100
awplus(config-router)# area 1 virtual-link 10.10.11.50 hello 5
dead 10
```

Related Commands [area authentication](#)
[show ip ospf](#)
[show ip ospf virtual-links](#)

auto-cost reference bandwidth

This command controls how OSPF calculates default metrics for the interface.

By default, OSPF calculates the OSPF metric for an interface by dividing the reference bandwidth by the interface bandwidth. The default value for the reference bandwidth is 100 Mbps. As a result, if this default value is used, there is very little difference between the metrics applied to interfaces of increasing bandwidth beyond 100 Mbps. The auto-cost command is used to alter this reference bandwidth in order to give a real difference between the metrics of high bandwidth links of differing bandwidths. In a network that has multiple links with high bandwidths, specify a larger reference bandwidth value to differentiate the costs on those links.

Use the **no** variant of this command to assign cost based only on the interface bandwidth.

Syntax `auto-cost reference-bandwidth <1-4294967>`
`no auto-cost reference-bandwidth`

Parameter	Description
<code><1-4294967></code>	The reference bandwidth in terms of Mbits per second (Mbps).

Default 100 Mbps

Mode Router Configuration

Example

```
awplus# configure terminal
awplus(config)# router ospf 100
awplus(config-router)# auto-cost reference-bandwidth 1000
```

Related Commands [ip ospf cost](#)

bandwidth

Use this command to specify the maximum bandwidth to be used for each VLAN interface. The bandwidth value is in bits. OSPF uses this to calculate metrics for the VLAN interface.

Use the **no** variant of this command to remove the maximum bandwidth.

Syntax `bandwidth <bandwidth-setting>`
`no bandwidth`

Parameter	Description
<code><bandwidth-setting></code>	Sets to bandwidth for the interface. Enter a value in the range 1 to 10000000000 bits.

Mode Interface Configuration for a VLAN interface.

Example

```
awplus# configure terminal
awplus(config)# interface vlan2
awplus(config-if)# bandwidth 1000000
```

Related Commands `show running-config`
`show running-config access-list`
`show interface`

capability opaque

This command enables opaque-LSAs. Opaque-LSAs are Type 9, 10 and 11 LSAs that deliver information used by external applications.

By default, opaque-LSAs are enabled.

Use the **no** variant of this command to disables opaque-LSAs.

Syntax `capability opaque`
`no capability opaque`

Mode Router Configuration

Example

```
awplus# configure terminal
awplus(config)# router ospf 100
awplus(config-router)# no capability opaque
```

capability restart

This command enables OSPF graceful restart or restart signaling features. By default, this is enabled.

Use the **no** variant of this command to disable OSPF graceful restart and restart signalling features.

Syntax `capability restart [graceful|signaling]`
`no capability restart`

Parameter	Description
<code>graceful</code>	Enable graceful OSPF restart.
<code>signaling</code>	Enable OSPF restart signaling.

Default Graceful restart.

Mode Router Configuration

Example

```
awplus# configure terminal
awplus(config)# router ospf 100
awplus(config-router)# capability restart graceful
```

clear ip ospf process

This command clears and restarts the OSPF routing process. Specify the Process ID to clear one particular OSPF process. When no Process ID is specified, this command clears all running OSPF processes.

Syntax `clear ip ospf [<0-65535>] process`

Parameter	Description
<code><0-65535></code>	The Routing Process ID.

Mode Privileged Exec

Example

```
awplus# clear ip ospf process
```

compatible rfc1583

This command changes the method used to calculate summary route to the that specified in RFC 1583. By default, OSPF uses the method specified in RFC 2328.

RFC 1583 specifies a method for calculating the metric for summary routes based on the minimum metric of the component paths available. RFC 2328 specifies a method for calculating metrics based on maximum cost.

It is possible that some ABRs in an area might conform to RFC 1583 and others support RFC 2328, which could lead to incompatibility in their interoperation. This command addresses this issue by allowing you to selectively disable compatibility with RFC 2328.

Use the **no** variant of this command to disable RFC 1583 compatibility.

Syntax `compatible rfc1583`
 `no compatible rfc1583`

Mode Router Configuration

Example

```
awplus# configure terminal
awplus(config)# router ospf 100
awplus(config-router)# compatible rfc1583
```

debug ospf events

This command enables OSPF debugging for OSPF event troubleshooting.

To enable all debugging options, specify **debug ospf event** with no additional parameters.

The **no** and **undebug** variant of this command disable OSPF debugging. Use this command without parameters to disable all the options.

Syntax `debug ospf events [abr] [asbr] [lsa] [nssa] [os] [router] [vlink]`
`no debug ospf events [abr] [asbr] [lsa] [nssa] [os] [router] [vlink]`

Parameter	Description
abr	Shows ABR events.
asbr	Shows ASBR events.
lsa	Shows LSA events.
nssa	Shows NSSA events.
os	Shows OS interaction events.
router	Shows other router events.
vlink	Shows virtual link events.

Mode Privileged Exec and Global Configuration

Example

```
awplus# debug ospf events asbr lsa
```

Related Commands [terminal monitor](#)
[undebug ospf events](#)

debug ospf ifsm

This command specifies debugging options for OSPF Interface Finite State Machine (IFSM) troubleshooting.

To enable all debugging options, specify **debug ospf ifsm** with no additional parameters.

The **no** and **undebug** variant of this command disable OSPF IFSM debugging. Use this command without parameters to disable all the options.

Syntax `debug ospf ifsm [status] [events] [timers]`
`no debug ospf ifsm [status] [events] [timers]`

Parameter	Description
events	Displays IFSM event information.
status	Displays IFSM status information.
timers	Displays IFSM timer information.

Mode Privileged Exec and Global Configuration

Example

```
awplus# no debug ospf ifsm events status
awplus# debug ospf ifsm status
awplus# debug ospf ifsm timers
```

Related Commands [terminal monitor](#)
[undebug ospf ifsm](#)

debug ospf lsa

This command enables debugging options for OSPF Link State Advertisements (LSA) troubleshooting. This displays information related to internal operations of LSAs.

To enable all debugging options, specify **debug ospf lsa** with no additional parameters.

The **no** and **undebug** variant of this command disable OSPF LSA debugging. Use this command without parameters to disable all the options.

Syntax `debug ospf lsa [flooding] [generate] [install] [maxage] [refresh]`
`no debug ospf lsa [flooding] [generate] [install] [maxage] [refresh]`

Parameter	Description
<code>flooding</code>	Displays LSA flooding.
<code>generate</code>	Displays LSA generation.
<code>install</code>	Show LSA installation.
<code>maxage</code>	Shows maximum age of the LSA in seconds.
<code>refresh</code>	Displays LSA refresh.

Mode Privileged Exec and Global Configuration

Examples

```
awplus# undebug ospf lsa refresh
```

Output Figure 36-1: Example output from the **debug ospf lsa** command

```
2002/05/09 14:08:11 OSPF: LSA[10.10.10.10:10.10.10.70]: instance(0x8139cd0) created
with Link State Update
2002/05/09 14:08:11 OSPF: RECV[LS-Upd]: From 10.10.10.70 via vlan5:10.10.10.50
(10.10.10.10 -> 224.0.0.5)
2002/05/09 14:12:33 OSPF: SEND[LS-Upd]: Begin send queue
2002/05/09 14:12:33 OSPF: SEND[LS-Upd]: # of LSAs 1, destination 224.0.0.5
2002/05/09 14:12:33 OSPF: SEND[LS-Upd]: End send queue
2002/05/09 14:12:33 OSPF: SEND[LS-Upd]: To 224.0.0.5 via vlan5:10.10.10.50
```

Related Commands [terminal monitor](#)
[undebug ospf lsa](#)

debug ospf nfsm

This command enables debugging options for OSPF Neighbor Finite State Machines (NFSMs).

To enable all debugging options, specify **debug ospf nfsm** with no additional parameters.

The **no** and **undebug** variant of this command disable OSPF NFSM debugging. Use this command without parameters to disable all the options.

Syntax `debug ospf nfsm [events] [status] [timers]`
`no debug ospf nfsm [events] [status] [timers]`

Parameter	Description
events	Displays NFSM event information.
status	Displays NFSM status information.
timers	Displays NFSM timer information.

Mode Privileged Exec and Global Configuration

Examples

```
awplus# debug ospf nfsm events  
awplus# no debug ospf nfsm timers  
awplus# undebug ospf nfsm events
```

Related Commands `terminal monitor`
`undebug ospf nfsm`

debug ospf nsm

This command enables debugging options for the OSPF Network Service Module.

To enable both debugging options, specify **debug ospf nsm** with no additional parameters.

The **no** and **undebug** variant of this command disable OSPF NSM debugging. Use this command without parameters to disable both options.

Syntax `debug ospf nsm [interface] [redistribute]`
`no debug ospf nsm [interface] [redistribute]`

Parameter	Description
interface	Specify NSM interface information.
redistribute	Specify NSM redistribute information.

Mode Privileged Exec and Global Configuration

Examples

```
awplus# debug ospf nsm interface
awplus# no debug ospf nsm redistribute
awplus# undebug ospf nsm interface
```

Related Commands [terminal monitor](#)
[undebug ospf nsm](#)

debug ospf packet

This command enables debugging options for OSPF packets.

To enable all debugging options, specify **debug ospf packet** with no additional parameters.

The **no** and **undebug** variant of this command disable OSPF packet debugging. Use this command without parameters to disable all options.

Syntax

```
debug ospf packet [dd] [detail] [hello] [ls-ack] [ls-request]
[ls-update] [recv] [send]

no debug ospf packet [dd] [detail] [hello] [ls-ack] [ls-request]
[ls-update] [recv] [send]
```

Parameter	Description
dd	Specifies debugging for OSPF database descriptions.
detail	Sets the debug option to detailed information.
hello	Specifies debugging for OSPF hello packets.
ls-ack	Specifies debugging for OSPF link state acknowledgments.
ls-request	Specifies debugging for OSPF link state requests.
ls-update	Specifies debugging for OSPF link state updates.
recv	Specifies the debug option set for received packets.
send	Specifies the debug option set for sent packets.

Mode Privileged Exec and Global Configuration

Examples

```
awplus# debug ospf packet detail
awplus# debug ospf packet dd send detail
awplus# no debug ospf packet ls-request recv detail
awplus# undebug ospf packet ls-request recv detail
```

Related Commands [terminal monitor](#)
[undebug ospf packet](#)

debug ospf route

This command enables debugging of route calculation. Use this command without parameters to turn on all the options.

To enable all debugging options, specify **debug ospf route** with no additional parameters.

The **no** and **undebug** variant of this command disable OSPF route debugging. Use this command without parameters to disable all options.

Syntax `debug ospf route [ase] [ia] [install] [spf]`
`no debug ospf route [ase] [ia] [install] [spf]`

Parameter	Description
ia	Specifies the debugging of Inter-Area route calculation
ase	Specifies the debugging of external route calculation
install	Specifies the debugging of route installation
spf	Specifies the debugging of SPF calculation

Mode Privileged Exec and Global Configuration

Examples

```
awplus# debug ospf route
awplus# no debug ospf route ia
awplus# debug ospf route install
awplus# undebug ospf route install
```

Related Commands [terminal monitor](#)
[undebug ospf route](#)

default-information originate (OSPF)

This command creates a default external route into an OSPF routing domain.

When you use the **default-information originate** command to redistribute routes into an OSPF routing domain, then the system acts like an Autonomous System Boundary Router (ASBR). An ASBR does not by default, generate a default route into the OSPF routing domain.

When using this command, also specify the **route-map WORD** option to avoid a dependency on the default network in the routing table.

The **metric-type** is an external link type associated with the default route advertised into the OSPF routing domain. The value of the external route could be either Type 1 or 2. The default is Type 2.

The **no** variant of this command disables this feature.

Syntax

```
default-information originate [always] [metric <metric>]
                             [metric-type <1-2>] [route-map <route-map>]

no default-information originate [always] [metric] [metric-type]
                                 [route-map]
```

Parameter	Description
<code>always</code>	Used to advertise the default route regardless of whether there is a default route.
<code>metric <metric></code>	The metric value used in creating the default route. Enter a value in the range 0 to 16777214. The default metric value is 10. The value used is specific to the protocol.
<code>metric-type <1-2></code>	External metric type for default routes, either OSPF External Type 1 or Type 2 metrics. Enter the value 1 or 2.
<code>route-map</code>	Specifies to use a specific route-map.
<code><route-map></code>	The route-map name. It is a string comprised of any characters, numbers or symbols.

Mode Router Configuration

Example

```
awplus# configure terminal
awplus(config)# router ospf 100
awplus(config-router)# default-information originate
always metric 23 metric-type 2
route-map myinfo
```

Related Commands [route-map](#)

default-metric (OSPF)

This command sets default metric values for the OSPF routing protocol.

The **no** variant of this command returns OSPF to using built-in, automatic metric translations, as appropriate for each routing protocol.

Syntax `default-metric <0-16777214>`
`no default-metric [<0-16777214>]`

Parameter	Description
<code><1-16777214></code>	Default metric value appropriate for the specified routing protocol.

Mode Router Configuration

Usage A default metric facilitates redistributing routes even with incompatible metrics. If the metrics do not convert, the default metric provides an alternative and enables the redistribution to continue. The effect of this command is that OSPF will use the same metric value for **all** redistributed routes. Use this command in conjunction with the [redistribute \(OSPF\)](#) command.

Examples

```
awplus# configure terminal
awplus(config)# router ospf 100
awplus(config-router)# default-metric 100

awplus# configure terminal
awplus(config)# router ospf 100
awplus(config-router)# no default-metric
```

Related commands [redistribute \(OSPF\)](#)

distance (OSPF)

This command sets the administrative distance for OSPF routes based on the route type. Your switch uses this value to select between two or more routes to the same destination from two different routing protocols. The route with the smallest administrative distance value is added to the Forwarding Information Base (FIB). See “[Administrative Distance](#)” on page 29.4 for more information.

Use the command **distance ospf** to set the distance for an entire category of OSPF routes, rather than the specific routes that pass an access list.

Use the command **distance <1-255>**, with no other parameter, to set the same distance for all OSPF route types.

The **no** variant of this command sets the administrative distance for all OSPF routes to the default of 110.

Syntax

```
distance <1-255>
distance ospf
    {external <1-255>|inter-area <1-255>|intra-area <1-255>}
no distance {ospf|<1-255>}
```

Parameter	Description
<1-255>	The OSPF routes Administrative Distance value.
external	Sets the distance for routes from other routing domains, learned by redistribution.
inter-area	Sets the distance for all routes from one area to another area.
intra-area	Sets the distance for all routes within an area.

Default The default OSPF administrative distance is 110. The default Administrative Distance for each type of route (intra, inter, or external) is 110.

Mode Router Configuration

Usage The administrative distance rates the trustworthiness of a routing information source. The distance could be any integer from 0 to 255. A higher distance value indicates a lower trust rating. For example, an administrative distance of 255 indicates that the routing information source cannot be trusted and should be ignored.

Use this command to set the distance for an entire group of routes, rather than a specific route that passes an access list.

Examples To set the following administrative distances for route types in OSPF 100:

- 20 for inter-area routes
- 10 for intra-area routes
- 40 for external routes

use the commands:

```
awplus(config)# router ospf 100
awplus(config-router)# distance ospf inter-area 20 intra-area 10
external 40
```

To set the administrative distance for all routes in OSPF 100 back to the default of 110, use the commands:

```
awplus(config)# router ospf 100
awplus(config-router)# no distance ospf
```

distribute-list (OSPF)

This command applies a filter to the choice of routes that will be redistributed from another routing protocol into OSPF.

The **no** variant of this command removes the distribute command.

Syntax

```
distribute-list <list-name> in
distribute-list <list-name> out {bgp|connected|rip|static}
no distribute-list <list-name> in
no distribute-list <list-name> out {bgp|connected|rip|static}
```

Parameter	Description
<list-name>	Specifies the name of the access list.
in	Indicates that this applies to incoming advertised routes.
out	Indicates that this applies to outgoing advertised routes.
bgp	Specifies that this applies to the redistribution of BGP routes.
connected	Specifies that this applies to the redistribution of connected routes.
rip	Specifies that this applies to the redistribution of RIP routes.
static	Specifies that this applies to the redistribution of static routes.

Mode Router Configuration

Example The following example shows the distribution of BGP routing updates based on access list 1 (network 172.10.0.0).

```
awplus# configure terminal
awplus(config)# access-list 1 permit 172.10.0.0
0.0.255.255
awplus(config)# router ospf 100
awplus(config-router)# distribute-list 1 out bgp
awplus(config-router)# redistribute bgp
```

Related Commands [redistribute \(OSPF\)](#)

enable db-summary-opt

This command enables OSPF database summary list optimization.

The **no** variant of this command disables database summary list optimization.

Syntax `enable db-summary-opt`
`no enable db-summary-opt`

Default The default setting is disabled.

Mode Router Configuration

Usage When this feature is enabled, the database exchange process is optimized by removing the LSA from the database summary list for the neighbor, if the LSA instance in the database summary list is the same as, or less recent than, the listed LSA in the database description packet received from the neighbor.

Examples To enable OSPF database summary list optimization, use the commands:

```
awplus# configure terminal
awplus(config)# router ospf
awplus(config-router)# enable db-summary-opt
```

To disable OSPF database summary list optimization, use the commands:

```
awplus# configure terminal
awplus(config)# router ospf
awplus(config-router)# no enable db-summary-opt
```

**Validation
Commands** `show running-config`

host area

This command configures a stub host entry belonging to a particular area. You can use this command to advertise specific host routes in the router-LSA as stub link. Since stub host belongs to the specified router, specifying cost is optional.

The **no** variant of this command removes the host area configuration.

Syntax `host <ip-address> area <area-id> [cost <0-65535>]`
`no host <ip-address> area <area-id> [cost <0-65535>]`

Parameter	Description
<code><ip-address></code>	The IPv4 address of the host, in dotted decimal notation.
<code><area-id></code>	The OSPF area ID of the transit area that configuring the stub host entry for. Use one of the following formats: <ul style="list-style-type: none"> ■ dotted decimal format, e.g., 0.0.1.2 ■ normal decimal format in the range <0-4294967295>, e.g., 258.
<code>cost <0-65535></code>	The cost for the stub host entry.

Default By default, no host entry is configured.

Mode Router Configuration

Example

```
awplus# configure terminal
awplus(config)# router ospf 100
awplus(config-router)# host 172.16.10.100 area 1
awplus(config-router)# host 172.16.10.101 area 2 cost 10
```

ip ospf authentication

This command sets the authentication method used when sending and receiving OSPF packets on the current VLAN interface. The default is to use no authentication.

If no authentication method is specified in this command, then plain text authentication will be used.

The **no** variant of this command disables the authentication.

Use the **ip ospf authentication-key** command to specify a Simple Text password. Use the **ip ospf message-digest-key** command to specify MD5 password.

Syntax `ip ospf [<ip-address>] authentication [message-digest|null]`
`no ip ospf [<ip-address>] authentication`

Parameter	Description
<ip-address>	The IP address of the interface.
message-digest	Use the message digest authentication.
null	Use no authentication. It overrides password or message-digest authentication of the interface.

Mode Interface Configuration for a VLAN interface.

Example In this example, interface `vlan1` is configured to have no authentication. This will override any text or MD5 authentication configured on this interface.

```
awplus# configure terminal
awplus(config)# interface vlan1
awplus(config-if)# ip ospf authentication null
```

Related Commands [ip ospf authentication-key](#)
[area authentication](#)
[ip ospf message-digest-key](#)

ip ospf authentication-key

This command specifies an OSPF authentication password for the neighboring routers.

This command creates a password (key) that is inserted into the OSPF header when AlliedWare Plus™ software originates routing protocol packets. Assign a separate password to each network for different VLAN interfaces. All neighboring routers on the same network with the same password exchange OSPF routing data.

The key can be used only when authentication is enabled for an area. Use the **area authentication** command to enable authentication.

Simple password authentication allows a password to be configured for each area. Configure the routers in the same routing domain with the same password.

The **no** variant of this command removes the OSPF authentication password.

Syntax

```
ip ospf [<ip-address>] authentication-key <pswd-long>
no ip ospf [<ip-address>] authentication-key
```

Parameter	Description
<ip-address>	The IPv4 address of the interface, in dotted decimal notation.
<pswd-long>	Specifies the authentication password. The string by the end of line will be used.

Default By default, an authentication password is not specified.

Mode Interface Configuration for a VLAN interface.

Example In the following example, an authentication key test is created on interface `vlan1` in area 0. Note that first authentication is enabled for area 0.

```
awplus# configure terminal
awplus(config)# router ospf 100
awplus(config-router)# network 10.10.10.0/24 area 0
awplus(config-router)# area 0 authentication
awplus(config-router)# exit
awplus(config)# interface vlan1
awplus(config-if)# ip ospf 3.3.3.3 authentication-key test
```

Related Commands

- [area authentication](#)
- [ip ospf authentication](#)

ip ospf cost

This command explicitly specifies the cost of the link-state metric in a router-LSA.

The interface cost indicates the overhead required to send packets across a certain VLAN interface. This cost is stated in the Router-LSA's link. Typically, the cost is inversely proportional to the bandwidth of an interface. By default, the cost of a VLAN interface is calculated according to the following formula:

$$\text{reference bandwidth} / \text{interface bandwidth}$$

To set the VLAN interface cost manually, use this command.

The **no** variant of this command resets the VLAN interface cost to the default value.

Syntax `ip ospf [<ip-address>] cost <1-65535>`
`no ip ospf [<ip-address>] cost`

Parameter	Description
<ip-address>	The IPv4 address of the interface, in dotted decimal notation.
<1-65535>	The link-state metric.

Default By default the reference bandwidth is 100 Mbps (10^8), but can be set to a different value by the command, [auto-cost reference bandwidth command on page 36.12](#).

Mode Interface Configuration for a VLAN interface.

Example The following example shows setting ospf cost to 10 on interface `vlan25` for IP address 10.10.10.50

```
awplus# configure terminal
awplus(config)# interface vlan25
awplus(config-if)# ip ospf 10.10.10.50 cost 10
```

Related Commands [show ip ospf interface](#)
[auto-cost reference bandwidth](#)

ip ospf database-filter

This command turns on the LSA database-filter for a particular VLAN interface.

The **no** variant of this command turns off the LSA database-filter.

Syntax `ip ospf [<ip-address>] database-filter all out`
`no ip ospf [<ip-address>] database-filter`

Parameter	Description
<ip-address>	The IPv4 address of the interface, in dotted decimal notation.

Default By default, all outgoing LSAs are flooded to the interface.

Mode Interface Configuration for a VLAN interface.

Usage OSPF floods new LSAs over all interfaces in an area, except the interface on which the LSA arrives. This redundancy ensures robust flooding. However, too much redundancy can waste bandwidth and might lead to excessive link and CPU usage in certain topologies, resulting in destabilizing the network. To avoid this, use the **ip ospf database-filter** command to block flooding of LSAs over specified interfaces.

Example

```
awplus# configure terminal
awplus(config)# interface vlan1
awplus(config-if# ip ospf database-filter all out
```

ip ospf dead-interval

This command sets the interval during which no hello packets are received and after which a neighbor is declared dead.

The dead-interval is the amount of time that OSPF waits to receive an OSPF hello packet from the neighbor before declaring the neighbor is down. This value is advertised in the router's hello packets. It must be a multiple of the hello-interval and be the same for all routers on a specific network.

The **no** variant of this command returns the interval to the default of 40 seconds. If you have configured this command specifying the IP address of the interface and want to remove the configuration, specify the IP address (**no ip ospf <ip-address> dead-interval**).

Syntax `ip ospf [<ip-address>] dead-interval <1-65535>`
`no ip ospf [<ip-address>] dead-interval`

Parameter	Description
<code><ip-address></code>	The IPv4 address of the interface, in dotted decimal notation.
<code><1-65545></code>	The interval in seconds. Default: 40

Mode Interface Configuration for a VLAN interface.

Example The following example shows configuring the dead-interval to 10 seconds on interface `vlan1`.

```
awplus# configure terminal
awplus(config)# interface vlan1
awplus(config-if)# ip ospf dead-interval 10
```

Related Commands `ip ospf hello-interval`
`show ip ospf interface`

ip ospf disable all

This command completely disables OSPF packet processing on a VLAN interface. It overrides the [network area](#) command and disables the processing of packets on the specific interface.

Use the **no** variant of this command to restore OSPF packet processing on a selected interface.

Syntax ip ospf disable all
no ip ospf disable all

Mode Interface Configuration for a VLAN interface.

Example

```
awplus# configure terminal
awplus(config)# interface vlan2
awplus(config-if)# ip ospf disable all
```

ip ospf hello-interval

This command specifies the interval between hello packets.

The hello-interval is advertised in the hello packets. Configure the same hello-interval for all routers on a specific network. A shorter hello interval ensures faster detection of topological changes, but results in more routing traffic.

The **no** variant of this command returns the interval to the default of 10 seconds.

Syntax `ip ospf [<ip-address>] hello-interval <1-65535>`
`no ip ospf [<ip-address>] hello-interval`

Parameter	Description
<ip-address>	The IP address of the interface, in dotted decimal notation.
<1-65535>	The interval in seconds. Default: 10

Default The default interval is 10 seconds.

Mode Interface Configuration for a VLAN interface.

Example The following example shows setting the hello-interval to 3 seconds on interface VLAN 2.

```
awplus# configure terminal
awplus(config)# interface vlan2
awplus(config-if)# ip ospf hello-interval 3
```

Related Commands `ip ospf dead-interval`
`show ip ospf interface`

ip ospf message-digest-key

This command registers an MD5 key for OSPF MD5 authentication.

Message Digest Authentication is a cryptographic authentication. A key (password) and key-id are configured on each router. The router uses an algorithm based on the OSPF packet, the key, and the key-id to generate a *message digest* that gets appended to the packet.

The **no** variant of this command removes the MD5 key.

Syntax `ip ospf [<ip-address>] message-digest-key <key-id> md5 <pswd-long>`
`no ip ospf [<ip-address>] message-digest-key <key-id>`

Parameter	Description
<ip-address>	The IPv4 address of the interface, in dotted decimal notation.
<key-id>	A key ID number specified as an integer between 1 and 255.
md5	Use the MD5 algorithm.
<pswd-long>	The OSPF password. This is a string of 1 to 16 characters including spaces.

Default By default, there is no MD5 key registered.

Mode Interface Configuration for a VLAN interface.

Usage Use this command for uninterrupted transitions between passwords. It allows you to add a new key without having to delete the existing key. While multiple keys exist, all OSPF packets will be transmitted in duplicate; one copy of the packet will be transmitted for each of the current keys. This is helpful for administrators who want to change the OSPF password without disrupting communication. The system begins a rollover process until all the neighbors have adopted the new password. This allows neighboring routers to continue communication while the network administrator is updating them with a new password. The router will stop sending duplicate packets once it detects that all of its neighbors have adopted the new password.

Maintain only one password per interface, removing the old password whenever you add a new one. This will prevent the local system from continuing to communicate with the system that is using the old password. Removing the old password also reduces overhead during rollover. All neighboring routers on the same network must have the same password value to enable exchange of OSPF routing data.

Examples The following example shows OSPF authentication on the interface VLAN 5 when IP address has not been specified.

```
awplus# configure terminal
awplus(config)# interface vlan5
awplus(config-if)# ip ospf authentication message-digest
awplus(config-if)# ip ospf message-digest-key 1 md5 yourpass
```

The following example shows configuring OSPF authentication on the interface VLAN 2 for the IP address 1.1.1.1. (If the interface has two IP addresses assigned-- 1.1.1.1 & 2.2.2.2, OSPF authentication will be enabled only for the IP address 1.1.1.1)

```
awplus# configure terminal
awplus(config)# interface vlan2
awplus(config-if)# ip ospf 1.1.1.1 authentication message-
digest
awplus(config-if)# ip ospf 1.1.1.1 message-digest-key 2 md5
yourpass
```

ip ospf mtu

This command sets the MTU size for OSPF. Whenever OSPF constructs packets, it uses VLAN interface MTU size as Maximum IP packet size. This command forces OSPF to use the specified value, overriding the actual VLAN interface MTU size.

Use the **no** variant of this command to return the MTU size to the default value.

Syntax `ip ospf mtu <576-65535>`

`no ip ospf mtu`

Default By default, OSPF uses interface MTU derived from the VLAN interface.

Mode Interface Configuration for a VLAN interface.

Usage This command allows an administrator to configure the MTU size recognized by the OSPF protocol. It does not configure the MTU settings on the VLAN interface. OSPF will not recognize MTU size configuration changes made to the kernel until the MTU size is updated through the CLI.

Example

```
awplus# configure terminal
awplus(config)# interface vlan2
awplus(config-if)# ip ospf mtu 1480
```

ip ospf mtu-ignore

Use this command to configure OSPF so that OSPF does not check the MTU size during DD (Database Description) exchange.

Use the **no** variant of this command to make sure that OSPF checks the MTU size during DD exchange.

Syntax `ip ospf [<ip-address>] mtu-ignore`
`no ip ospf [<ip-address>] mtu-ignore`

Parameter	Description
<code><ip-address></code>	IPv4 address of the interface, in dotted decimal notation.

Mode Interface Configuration for a VLAN interface.

Usage By default, during the DD exchange process, OSPF checks the MTU size described in the DD packets received from the neighbor. If the MTU size does not match the interface MTU, the neighbor adjacency is not established. Using this command makes OSPF ignore this check and allows establishing of adjacency regardless of MTU size in the DD packet.

Example

```
awplus# configure terminal
awplus(config)# interface vlan2
awplus(config-router)# ip ospf mtu-ignore
```

ip ospf network

This command configures the OSPF network type to a type different from the default for the particular VLAN interface.

The **no** variant of this command returns the network type to the default for the particular VLAN interface.

Syntax `ip ospf network [broadcast | non-broadcast | point-to-point | point-to-multipoint]`
`no ip ospf network`

Parameter	Description
<code>broadcast</code>	Sets the network type to broadcast.
<code>non-broadcast</code>	Sets the network type to NBMA.
<code>point-to-multipoint</code>	Sets the network type to point-to-multipoint.
<code>point-to-point</code>	Sets the network type to point-to-point.

Mode Interface Configuration for a VLAN interface.

Mode The default is the `broadcast` OSPF network type for a VLAN interface.

Usage This command forces the interface network type to the specified type. Depending on the network type, OSPF changes the behavior of the packet transmission and the link description in LSAs.

Example The following example shows setting the network type to **point-to-point** on the `vlan1` interface.

```
awplus# configure terminal
awplus(config)# interface vlan1
awplus(config-if)# ip ospf network point-to-point
```

ip ospf priority

This command sets the router priority, which is a parameter used in the election of the designated router for the network.

The **no** variant of this command returns the router priority to the default of 1.

Syntax `ip ospf [<ip-address>] priority <priority>`
`no ip ospf [<ip-address>] priority`

Parameter	Description
<ip-address>	The IP address of the interface.
<priority>	<0-255> Specifies the Router Priority of the interface.

Default The default priority is 1.

Mode Interface Configuration for a VLAN interface.

Usage Set the priority to help determine the OSPF Designated Router (DR) for a network. If two routers attempt to become the DR, the router with the higher router priority becomes the DR. If the router priority is the same for two routers, the router with the higher router ID takes precedence.

Only routers with nonzero router priority values are eligible to become the designated or backup designated router.

Configure router priority for multiaccess networks only and not for point-to-point networks.

Example The following example shows setting the OSPF priority value to 3 on the `vlan2` interface.

```
awplus# configure terminal
awplus(config)# interface vlan2
awplus(config-if)# ip ospf priority 3
```

Related Commands [ip ospf network](#)

ip ospf resync-timeout

Use this command to set the interval after which adjacency is reset if out-of-band resynchronization has not occurred. The interval period starts from the time a restart signal is received from a neighbor.

Use the **no** variant of this command to return to the default value.

Syntax `ip ospf [<ip-address>] resync-timeout <1-65535>`
`no ip ospf [<ip-address>] resync-timeout`

Parameter	Description
<code><ip-address></code>	The IP address of the interface.
<code><1-65535></code>	Specifies the resynchronization timeout value of the interface in seconds.

Mode Interface Configuration for a VLAN interface.

Example The following example shows setting the OSPF resynchronization timeout value to 65 seconds on the `vlan2` interface.

```
awplus# configure terminal
awplus(config)# interface vlan2
awplus(config-if)# ip ospf resync-timeout 65
```

ip ospf retransmit-interval

Use this command to specify the time between link-state advertisement (LSA) retransmissions for adjacencies belonging to the interface.

Use the **no** variant of this command to return to the default value of 5 seconds.

Syntax `ip ospf [<ip-address>] retransmit-interval <1-65535>`
`no ip ospf [<ip-address>] retransmit-interval`

Parameter	Description
<ip-address>	The IP address of the interface.
<1-65535>	Specifies the interval in seconds.

Default The default interval is 5 seconds.

Mode Interface mode for a VLAN interface.

Usage After sending an LSA to a neighbor, the router keeps the LSA until it receives an acknowledgement. In case the router does not receive an acknowledgement during the set time (the retransmit interval value) it retransmits the LSA. Set the retransmission interval value conservatively to avoid needless retransmission. The interval should be greater than the expected round-trip delay between two routers.

Example The following example shows setting the `ospf retransmit interval` to 6 seconds on the `vlan2` interface.

```
awplus# configure terminal
awplus(config)# interface vlan2
awplus(config-if)# ip ospf retransmit-interval 6
```

ip ospf transmit-delay

Use this command to set the estimated time it takes to transmit a link-state-update packet on the VLAN interface.

Use the **no** variant of this command to return to the default value of 1 second.

Syntax `ip ospf [<ip-address>] transmit-delay <1-65535>`
`no ip ospf [<ip-address>] transmit-delay`

Parameter	Description
<ip-address>	The IP address of the VLAN interface.
<1-65535>	Specifies the time, in seconds, to transmit a link-state update.

Default The default interval is 1 second.

Mode Interface Configuration for a VLAN interface.

Usage The transmit delay value adds a specified time to the age field of an update. If the delay is not added, the time in which the LSA transmits over the link is not considered. This command is especially useful for low speed links. Add transmission and propagation delays when setting the transmit delay value.

Example The following example shows setting the OSPF transmit delay time to 3 seconds on the `vlan2` interface.

```
awplus# configure terminal
awplus(config)# interface vlan2
awplus(config-if)# ip ospf transmit-delay 3
```

max-concurrent-dd

Use this command to set the limit for the number of Database Descriptors (DD) that can be processed concurrently.

Use the **no** variant of this command to reset the limit for the number of Database Descriptors (DD) that can be processed concurrently.

Syntax `max-concurrent-dd <1-65535>`

`no max-concurrent-dd`

Parameter	Description
<code><1-65535></code>	Specify the number of DD processes.

Mode Router Configuration

Usage This command is useful when a router's performance is affected from simultaneously bringing up several OSPF adjacencies. This command limits the maximum number of DD exchanges that can occur concurrently per OSPF instance, thus allowing for all of the adjacencies to come up.

Example The following example sets the max-concurrent-dd value to 4, so that only 4 DD exchanges will be processed at a time.

```
awplus# configure terminal
awplus(config)# router ospf 100
awplus(config-router# max-concurrent-dd 4
```

maximum-area

Use this command to set the maximum number of OSPF areas.

Use the **no** variant of this command to set the maximum number of OSPF areas to the default value.

Syntax `maximum-area <1-4294967294>`
`no maximum-area`

Parameter	Description
<code><1-4294967294></code>	Specify the maximum number of OSPF areas.

Default The default value for the maximum number of OSPF areas is 4294967294.

Mode Router Configuration

Usage Use this command in router OSPF mode to specify the maximum number of OSPF areas.

Examples The following example sets the maximum number of OSPF areas to 2:

```
awplus# configure terminal
awplus(config)# router ospf 100
awplus(config-router)# maximum-area 2
```

The following example removes the maximum number of OSPF areas and resets to default:

```
awplus# configure terminal
awplus(config)# router ospf 100
awplus(config-router)# no maximum-area
```

neighbor (OSPF)

Use this command to inform the router of other neighboring routers that are connected to the same NBMA network.

Use the **no** variant of this command to remove a configuration.

Syntax `neighbor <ip-address> [<cost>]{<priority>|<poll-interval>}`
`no neighbor <ip-address> [<cost>]{<priority>|<poll-interval>}`

Parameter	Description
<code><ip-address></code>	Specifies the interface IP address of the neighbor.
<code><priority></code>	<code>priority <0-255></code> specifies the router priority value of the non-broadcast neighbor associated with the specified IP address. The default value is 0. This keyword does not apply to point-to-multipoint interfaces.
<code><poll-interval></code>	<code>poll-interval <1-65535></code> Dead neighbor polling interval in seconds. It is recommended to set this value much higher than the hello interval. The default value is 120 seconds.
<code><cost></code>	<code>cost <1-65535></code> Specifies the link-state metric to this neighbor.

Mode Router Configuration

Usage To configure a neighbor on an NBMA network manually, use the `neighbor` command and include one neighbor entry for each known nonbroadcast network neighbor. The IP address used in this command is the neighbor's primary IP address on the interface where that neighbor connects to the NBMA network.

The poll interval is the reduced rate at which routers continue to send hello packets, when a neighboring router has become inactive. Set the poll interval to be much larger than hello interval.

Examples This example shows a neighbor configured with a priority value, poll interval time, and cost.

```
awplus# configure terminal
awplus(config)# router ospf 100
awplus(config-router)# neighbor 1.2.3.4 priority 1 poll-
interval 90
awplus(config-router)# neighbor 1.2.3.4 cost 15
```

network area

Use this command to enable OSPF routing with a specified Area ID on any interfaces with IP addresses that match the specified network address.

Use the **no** variant of this command to disable OSPF routing on the interfaces.

Syntax `network <network-address> area <area-id>`
`no network <network-address> area <area-id>`

Parameter	Description
<code><network-address></code>	{ <code><ip-network/m></code> <code><ip-addr> <reverse-mask></code> }
<code><ip-network/m></code>	IP address of the network, entered in the form A.B.C.D/M. Dotted decimal notation followed by a forward slash, and then the subnet mask length.
<code><ip-addr></code>	IPv4 network address, entered in the form A.B.C.D.
<code><reverse-mask></code>	Reverse mask in dotted decimal format. Note that the term reverse-mask is sometimes referred to as a Wildcard mask.
<code><area-id></code>	{ <code><ip-addr></code> <code><0-4294967295></code> }
<code><ip-addr></code>	OSPF Area ID in IPv4 address format, in the form A.B.C.D.
<code><0-4294967295></code>	OSPF Area ID as 4 octets unsigned integer value.

Default No **network area** is configured by default.

Mode Router Configuration

Usage OSPF routing can be enabled per IPv4 subnet. The network address can be defined using either the prefix length or a wild card mask. A wild card mask is comprised of consecutive 0's as network bits and consecutive 1's as host bits.

Examples The following commands show the use of the the **network area** command with OSPF multiple instance support disabled:

```
awplus# configure terminal
awplus(config)# router ospf 100
awplus(config-router)# network 10.0.0.0/8 area 3
awplus(config-router)# network 10.0.0.0/8 area 1.1.1.1
```

The following commands disable OSPF routing with Area ID 3 on all interfaces:

```
awplus# configure terminal
awplus(config)# router ospf 100
awplus(config-router)# no network 10.0.0.0/8 area3
```

ospf abr-type

Use this command to set an OSPF Area Border Router (ABR) type.

Use the **no** variant of this command to revert the ABR type to the default setting (Cisco).

Syntax `ospf abr-type {cisco|ibm|standard}`
`no ospf abr-type {cisco|ibm|standard}`

Parameter	Description
<code>cisco</code>	Specifies an alternative ABR using Cisco implementation (RFC 3509). This is the default ABR type.
<code>ibm</code>	Specifies an alternative ABR using IBM implementation (RFC 3509).
<code>standard</code>	Specifies a standard behavior ABR (RFC 2328).

Default ABR type `cisco`

Mode Router Configuration

Usage Specifying the ABR type allows better interoperability between different implementations. This command is specially useful in a multi-vendor environment. The different ABR types are:

- **Cisco ABR Type:** By this definition, a router is considered an ABR if it has more than one area actively attached and one of them is the backbone area.
- **Standard ABR Type:** By this definition, a router is considered an ABR if it has more than one area actively attached to it.
- **IBM ABR Type:** By this definition, a router is considered an ABR if it has more than one area actively attached and the backbone area is configured. In this case the configured backbone need not be actively connected.

Example

```
awplus# configure terminal
awplus(config)# router ospf 100
awplus(config-router)# ospf abr-type ibm
```

ospf restart grace-period

Use this command to configure the grace-period for restarting OSPF routing.

Use the **no** variant of this command to revert to the default grace-period.

Syntax `ospf restart grace-period <1-1800>`
`no ospf restart grace-period`

Parameter	Description
<code><1-1800></code>	Specifies the grace period in seconds.

Default In the AlliedWare Plus™ OSPF implementation, the default OSPF grace-period is 60 seconds.

Mode Global Configuration

Usage Use this command to enable the OSPF Graceful Restart feature and set the restart grace-period. Changes from the default restart grace-period are displayed in the running-config. The restart grace-period is not displayed in the running-config if it has been reset to the default using the **no** variant of this command.

Example To set the OSPF restart grace-period to 250 seconds, use the following commands:

```
awplus# configure terminal
awplus(config)# ospf restart grace-period 250
```

**Validation
Commands** `show running-config`

Related Commands `ospf restart helper`
`restart ospf graceful`

ospf restart helper

Use this command to configure the **helper** behavior for the OSPF Graceful Restart feature.

Use the **no** variant of this command to revert to the default grace-period.

Syntax

```
ospf restart helper
    {max-grace-period <1-1800>|never|only-reload|only-upgrade}
no ospf restart helper [max-grace-period]
```

Parameter	Description
max-grace-period	Help only if received grace-period is less than specified value.
<1-1800>	Maximum grace period to accept, in seconds.
never	Local Policy to never to act as Helper.
only-reload	Help only on software reloads.
only-upgrade	Help only on software upgrades.
max-grace-period	Help only if received grace-period is less than this value.

Default The default OSPF grace-period is 60 seconds.

Mode Global Configuration

Usage The **ospf restart helper** command requires at least one parameter, but you may use more than one in the same command (excluding parameter **never**).

The **no** variant of this command will turn off the OSPF restart helper, while the **no ospf restart helper max-grace-period** command will reset the max-grace-period rather than the helper policy itself.

Example

```
awplus# configure terminal
awplus(config)# ospf restart helper only-reload
```

Related Commands

- [ospf restart grace-period](#)
- [restart ospf graceful](#)

ospf router-id

Use this command to specify a router ID for the OSPF process.

Use the **no** variant of this command to disable this function.

Syntax `ospf router-id <ip-address>`
`no ospf router-id`

Parameter	Description
<code><ip-address></code>	Specifies the router ID in IPv4 address format.

Mode Router Configuration

Usage Configure each router with a unique router-id. In an OSPF router process that has active neighbors, a new router-id takes effect at the next reload or when you restart OSPF manually.

Example The following example shows a specified router ID 2.3.4.5.

```
awplus# configure terminal
awplus(config)# router ospf 100
awplus(config-router)# ospf router-id 2.3.4.5
```

Related Commands [show ip ospf](#)

overflow database

Use this command to limit the maximum number of Link State Advertisements (LSAs) that can be supported by the current OSPF instance.

Use the **no** variant of this command to have no limit on the maximum number of LSAs.

Syntax `overflow database <0-4294967294> {hard|soft}`
`no overflow database`

Parameter	Description
<0-4294967294>	The maximum number of LSAs
hard	Shutdown occurs if the number of LSAs exceeds the specified value.
soft	Warning message appears if the number of LSAs exceeds the specified value.

Mode Router Configuration

Usage Use **hard** with this command if a shutdown is required if the number of LSAs exceeds the specified number. Use **soft** with this command if a shutdown is not required, but a warning message is required, if the number of LSAs exceeds the specified number.

Example The following example shows setting the database overflow to 500, and a shutdown to occur, if the number of LSAs exceeds 500.

```
awplus# configure terminal
awplus(config)# router ospf 100
awplus(config-router)# overflow database 500 hard
```

overflow database external

Use this command to configure the size of the external database and the time the router waits before it tries to exit the overflow state.

Use the **no** variant of this command to revert to default.

Syntax `overflow database external <max-lsas> <recover-time>`
`no overflow database external`

Parameter	Description
<code><max-lsas></code>	<code><0-2147483647></code> The maximum number of Link State Advertisements (LSAs). Note that this value should be the same on all routers in the AS.
<code><recover-time></code>	<code><0-65535></code> the number of seconds the router waits before trying to exit the database overflow state. If this parameter is 0, router exits the overflow state only after an explicit administrator command.

Mode Router Configuration

Usage Use this command to limit the number of AS-external-LSAs a router can receive, once it is in the wait state. It takes the number of seconds specified as the `<recover-time>` to recover from this state.

Example The following example shows setting the maximum number of LSAs to 5 and the time to recover from overflow state to be 3:

```
awplus# configure terminal
awplus(config)# router ospf 100
awplus(config-router)# overflow database external 50 3
```

passive-interface (OSPF)

Use this command to suppress the sending of Hello packets on all interfaces, or on a specified interface. If you use the **passive-interface** command without the optional parameters then **all** interfaces are put into passive mode.

Use the **no** variant of this command to allow the sending of Hello packets on all interfaces, or on the specified interface. If you use the **no** variant of this command without the optional parameters then **all** interfaces are removed from passive mode.

Syntax `passive-interface [<interface>][<ip-address>]`

`no passive-interface [<interface>][<ip-address>]`

Parameter	Description
<code><interface></code>	The name of the interface.
<code><ip-address></code>	IP address of the interface, entered in the form A.B.C.D

Mode Router Configuration

Usage Configure an interface to be passive if you wish its connected route to be treated as an OSPF route (rather than an AS-external route), but do not wish to actually exchange any OSPF packets via this interface.

Examples To configure passive interface mode on interface **vlan2**, enter the following commands:

```
awplus(config)# router ospf 100
awplus(config-router)# passive-interface vlan2
```

To configure passive interface mode on **all** interfaces, enter the following commands:

```
awplus(config)# router ospf 100
awplus(config-router)# passive-interface
```

To remove passive interface mode on interface **vlan2**, enter the following commands:

```
awplus(config)# router ospf 100
awplus(config-router)# no passive-interface vlan2
```

To remove passive interface mode on **all** interfaces, enter the following commands:

```
awplus(config)# router ospf 100
awplus(config-router)# no passive-interface
```

redistribute (OSPF)

Use this command to redistribute routes from other routing protocols, static routes and connected routes into an ospf routing table.

Use the **no** variant of this command to disable this function.

Syntax `redistribute {<protocol>} {metric|metric-type|route-map|tag}`
`no redistribute {<protocol>} {metric|metric-type|route-map|tag}`

Parameter	Description								
<code><protocol></code>	Specify one of: <table border="1"> <tbody> <tr> <td><code>bgp</code></td> <td>Specifies BGP routes.</td> </tr> <tr> <td><code>rip</code></td> <td>Specifies RIP routes.</td> </tr> <tr> <td><code>connected</code></td> <td>Specifies connected routes.</td> </tr> <tr> <td><code>static</code></td> <td>Specifies static routes.</td> </tr> </tbody> </table>	<code>bgp</code>	Specifies BGP routes.	<code>rip</code>	Specifies RIP routes.	<code>connected</code>	Specifies connected routes.	<code>static</code>	Specifies static routes.
<code>bgp</code>	Specifies BGP routes.								
<code>rip</code>	Specifies RIP routes.								
<code>connected</code>	Specifies connected routes.								
<code>static</code>	Specifies static routes.								
<code>metric</code>	<code>metric <0-16777214></code> Specifies the external metric.								
<code>metric-type</code>	<code>metric-type {1 2}</code> Specifies the external metric-type.								
<code>route-map</code>	<code>route-map WORD</code> Specifies name of the route-map.								
<code>tag</code>	<code>tag <0-4294967295></code> Specifies the external route tag.								

Mode Router Configuration

Usage You use this command to inject routes, learnt from other routing protocols, into the OSPF domain to generate AS-external-LSAs. If a route-map is configured by this command, then that route-map is used to control which routes are redistributed and can set metric and tag values on particular routes.

The metric, metric-type, and tag values specified on this command are applied to any redistributed routes that are not explicitly given a different metric, metric-type, or tag value by the route map.

Example The following example shows redistribution of bgp routes into ospf routing table, with metric 12.

```
awplus# configure terminal
awplus(config)# router ospf 100
awplus(config-router)# redistribute bgp metric 12
```

restart ospf graceful

Use this command to force the OSPF process to restart.

Syntax `restart ospf graceful [grace-period <1-1800>]`

Parameter	Description
<code>grace-period</code>	Specify the grace period.
<code><1-1800></code>	The grace period in seconds.

Default The default OSPF grace-period is 60 seconds.

Mode Privileged Exec

Usage After this command is executed, the OSPF process immediately shuts down. It notifies the system that OSPF has performed a graceful shutdown. Routes installed by OSPF are preserved until the grace-period expires.

- When a `restart ospf graceful` command is issued, the OSPF configuration is reloaded from the last saved configuration. Ensure you first enter the command `copy running-config startup-config`.

Example

```
awplus# copy running-config startup-config
awplus# restart ospf graceful grace-period 200
```

Related Commands [ospf restart grace-period](#)
[ospf restart helper](#)

router ospf

Use this command to enter Router Configuration mode to configure an OSPF routing process. You must specify the process ID with this command for multiple OSPF routing processes on the switch.

Use the **no** variant of this command to terminate an OSPF routing process.

Use the **no** parameter with the **process-id** parameter, to terminate and delete a specific OSPF routing process. If no **process-id** is specified on the **no** variant of this command, then all OSPF routing processes are terminated, and all OSPF configuration is removed.

Syntax `router ospf <process-id>`
`no router ospf [<process-id>]`

Parameter	Description
<code><process-id></code>	<code><1-65535></code> Any positive integer identifying a routing process.

Default No routing process is defined by default.

Mode Global Configuration

Usage The process ID of OSPF is an optional parameter for the **no** variant of this command only. When removing all instances of OSPF, you do not need to specify each Process ID, but when removing particular instances of OSPF you must specify each Process ID to be removed.

Example This example shows the use of this command to enter Router Configuration mode.

```
awplus# configure terminal
awplus(config)# router ospf 100
awplus(config-router)#
```

router-id

Use this command to specify a router ID for the OSPF process.

Use the **no** variant of this command to force OSPF to use the previous OSPF router-id behavior.

Syntax `router-id <ip-address>`
`no router-id`

Parameter	Description
<code><ip-address></code>	Specifies the router ID in IPv4 address format.

Mode Router Configuration

Usage Configure each router with a unique router-id. In an OSPF router process that has active neighbors, a new router-id is used at the next reload or when you restart OSPF manually.

Example The following example shows a fixed router ID 10.10.10.60

```
awplus# configure terminal
awplus(config)# router ospf 100
awplus(config-router)# router-id 10.10.10.60
```

Related Commands [show ip ospf](#)

show debugging ospf

Use this command to display which OSPF debugging options are currently enabled.

For information on output options, see ["Controlling "show" Command Output" on page 1.35.](#)

Syntax `show debugging ospf`

Mode Privileged Exec

Example

```
awplus# show debugging ospf
```

Output Figure 36-2: Example output from the **show debugging ospf** command

```
OSPF debugging status:
  OSPF packet Link State Update debugging is on
  OSPF all events debugging is on
```

show ip ospf

Use this command to display general information about all OSPF routing processes. Include the process ID parameter with this command to display information about specified instances.

For information on output options, see [“Controlling “show” Command Output” on page 1.35.](#)

Syntax `show ip ospf`
`show ip ospf <process-id>`

Parameter	Description
<code><process-id></code>	<code><0-65535></code> The ID of the router process for which information will be displayed. If this parameter is included, only the information for the specified routing process is displayed.

Mode User Exec and Privileged Exec

Examples To display general information about all OSPF routing processes, use the command:

```
awplus# show ip ospf
```

To display general information about OSPF routing process 100, use the command:

```
awplus# show ip ospf 100
```

Output Figure 36-3: Example output from the **show ip ospf** command

```

Routing Process "ospf 1" with ID 10.10.11.60
Process uptime is 46 minutes
Conforms to RFC2328, and RFC1583Compatibility flag is disabled
Supports only single TOS(TOS0) routes
Supports opaque LSA
This router is an ASBR (injecting external routing information)
SPF schedule delay 5 secs, Hold time between two SPFs 10 secs
Refresh timer 10 secs
Number of external LSA 1. Checksum Sum 0xBC1E
Number of non-default external LSA 1
External LSA database is unlimited.
Number of areas attached to this router: 1
  Area 0 (BACKBONE)
    Number of interfaces in this area is 1(1)
    Number of fully adjacent neighbors in this area is 1
    Area has no authentication
    SPF algorithm last executed 00:46:27.935 ago
    SPF algorithm executed 2 times
    Number of LSA 5. Checksum Sum 0x026a20
Routing Process "ospf 100" with ID 10.10.11.146
Process uptime is 0 minute
Conforms to RFC2328, and RFC1583Compatibility flag is disabled
Supports only single TOS(TOS0) routes
Supports opaque LSA
SPF schedule delay 5 secs, Hold time between two SPFs 10 secs
Refresh timer 10 secs
Number of external LSA 0. Checksum Sum 0x0
Number of non-default external LSA 0
External LSA database is unlimited.
Number of areas attached to this router: 1
  Area 1
    Number of interfaces in this area is 1(1)
    Number of fully adjacent neighbors in this area is 0
    Number of fully adjacent virtual neighbors through this
area is 0
    Area has no authentication
    SPF algorithm executed 0 times
    Number of LSA 1. Checksum Sum 0x00e3e2

```

Figure 36-4: Example output from the **show ip ospf <process-id>** command

```

Routing Process "ospf 100" with ID 10.10.11.146
Process uptime is 0 minute
Conforms to RFC2328, and RFC1583Compatibility flag is disabled
Supports only single TOS(TOS0) routes
Supports opaque LSA
SPF schedule delay 5 secs, Hold time between two SPFs 10 secs
Refresh timer 10 secs
Number of external LSA 0. Checksum Sum 0x0
Number of non-default external LSA 0
External LSA database is unlimited.
Number of areas attached to this router: 1
  Area 1
    Number of interfaces in this area is 1(1)
    Number of fully adjacent neighbors in this area is 0
    Number of fully adjacent virtual neighbors through this
area is 0
    Area has no authentication
    SPF algorithm executed 0 times
    Number of LSA 1. Checksum Sum 0x00e3e2

```

Related Commands [router ospf](#)

show ip ospf border-routers

Use this command to display the ABRs and ASBRs for all OSPF instances. Include the process ID parameter with this command to view data about specified instances.

For information on output options, see [“Controlling “show” Command Output” on page 1.35.](#)

Syntax `show ip ospf border-routers`
`show ip ospf <process-id> border-routers`

Parameter	Description
<process-id>	<0-65535> The ID of the router process for which information will be displayed.

Mode User Exec and Privileged Exec

Output Figure 36-5: Example output from the `show ip ospf border-routers` command

```
OSPF process 1 internal Routing Table
Codes: i - Intra-area route, I - Inter-area route
i 10.15.0.1 [10] via 10.10.0.1, vlan2, ASBR, Area 0.0.0.0
i 172.16.10.1 [10] via 10.10.11.50, vlan3, ABR, ASBR, Area
0.0.0.0
```

show ip ospf database

Use this command to display a database summary for OSPF information. This command displays BGP tags for prefixes. Include the process ID parameter with this command to display information about specified instances.

For information on output options, see [“Controlling “show” Command Output” on page 1.35.](#)

Syntax `show ip ospf database [self-originate|max-age]`
`show ip ospf <process-id> database [self-originate|max-age]`

Parameter	Description
<process-id>	<0-65535> The ID of the router process for which information will be displayed.
self-originate	Displays self-originated link states.
max-age	Displays LSAs in MaxAge list. It maintains the list of the all LSAs in the database which have reached the max-age which is 3600 seconds.

Mode User Exec and Privileged Exec

Examples To display the ABRs and ASBRs for all OSPF instances, use the command:

```
awplus# show ip ospf border-routers
```

To display the ABRs and ASBRs for the specific OSPF instance 721, use the command:

```
awplus# show ip ospf 721 border-routers
```

Output Figure 36-6: Example output from the `show ip ospf database` command

```

      OSPF Router process 1 with ID (10.10.11.60)
      Router Link States (Area 0.0.0.1)
Link ID      ADV Router      Age  Seq#      CkSum  Link count
10.10.11.60  10.10.11.60      32  0x80000002 0x472b  1
      OSPF Router process 100 with ID (10.10.11.60)
      Router Link States (Area 0.0.0.0)
Link ID      ADV Router      Age  Seq#      CkSum  Link count
10.10.11.60  10.10.11.60      219 0x80000001 0x4f5d  0

```

Example

```
awplus# show ip ospf database external 1.2.3.4 self-originate
awplus# show ip ospf database self-originate
```

Figure 36-7: Example output from the `show ip ospf database self-originate` command

```

      OSPF Router process 100 with ID (10.10.11.50)
      Router Link States (Area 0.0.0.1 [NSSA])
Link ID      ADV Router      Age  Seq#      CkSum  Link count
10.10.11.50  10.10.11.50     20  0x80000007 0x65c3  2
      Area-Local Opaque-LSA (Area 0.0.0.1 [NSSA])
Link ID      ADV Router      Age  Seq#      CkSum  Opaque ID
67.1.4.217   10.10.11.50     37  0x80000001 0x2129  66777
      AS-Global Opaque-LSA
Link ID      ADV Router      Age  Seq#      CkSum  Opaque ID
67.1.4.217   10.10.11.50     37  0x80000001 0x2daa  66777
  
```

show ip ospf database asbr-summary

Use this command to display information about the Autonomous System Boundary Router (ASBR) summary LSAs.

For information on output options, see “Controlling “show” Command Output” on page 1.35.

Syntax `show ip ospf database asbr-summary [<ip-addr>]`
`[self-originate|<advrouter>]`

Parameter	Description
<i><advrouter></i>	adv-router <i><ip-address></i>
adv-router	Displays all the LSAs of the specified router.
<i><ip-addr></i>	A link state ID, as an IP address.
self-originate	Displays self-originated link states.

Mode User Exec and Privileged Exec

Examples

```

awplus# show ip ospf database asbr-summary 1.2.3.4 self-originate

awplus# show ip ospf database asbr-summary self-originate

awplus# show ip ospf database asbr-summary 1.2.3.4 adv-router
2.3.4.5
  
```

show ip ospf database external

Use this command to display information about the external LSAs.

For information on output options, see “Controlling “show” Command Output” on page 1.35.

Syntax `show ip ospf database external [<ip-addr>] [self-originate|<advrouter>]`

Parameter	Description
<advrouter>	adv-router <ip-address>
adv-router	Displays all the LSAs of the specified router.
<ip-addr>	A link state ID, as an IP address.
self-originate	Displays self-originated link states.

Mode User Exec and Privileged Exec

Examples

```
awplus# show ip ospf database external 1.2.3.4 self-originate
awplus# show ip ospf database external self-originate
awplus# show ip ospf database external 1.2.3.4 adv-router
2.3.4.5
```

Output Figure 36-8: Example output from the `show ip ospf database external self-originate` command

```

      OSPF Router process 100 with ID (10.10.11.50)
        AS External Link States
LS age: 298
Options: 0x2 (*|---|E|)
LS Type: AS-external-LSA
Link State ID: 10.10.100.0 (External Network Number)
Advertising Router: 10.10.11.50
LS Seq Number: 80000001
Checksum: 0x7033
Length: 36
Network Mask: /24
    Metric Type: 2 (Larger than any link state path)
    TOS: 0
    Metric: 20
    Forward Address: 10.10.11.50
    External Route Tag: 0
```

show ip ospf database network

Use this command to display information about the network LSAs.

For information on output options, see “Controlling “show” Command Output” on page 1.35.

Syntax `show ip ospf database network [<ip-addr>]
[self-originate|<advrouter>]`

Parameter	Description
<advrouter>	adv-router <ip-address>
adv-router	Displays all the LSAs of the specified router.
<ip-addr>	A link state ID, as an IP address.
self-originate	Displays self-originated link states.

Mode User Exec and Privileged Exec

Examples

```
awplus# show ip ospf database network 1.2.3.4 self-originate
awplus# show ip ospf database network self-originate
awplus# show ip ospf database network 1.2.3.4 adv-router
2.3.4.5
```

Output Figure 36-9: Example output from the `show ip ospf database network` command

```

      OSPF Router process 200 with ID (192.30.30.2)
      Net Link States (Area 0.0.0.0)
LS age: 1387
Options: 0x2 (*|---|E|)
LS Type: network-LSA
Link State ID: 192.10.10.9 (address of Designated Router)
Advertising Router: 192.30.30.3
LS Seq Number: 80000001
Checksum: 0xe1b0
Length: 32
Network Mask: /24
    Attached Router: 192.20.20.1
    Attached Router: 192.30.30.3
LS age: 1648
Options: 0x2 (*|---|E|)
LS Type: network-LSA
Link State ID: 192.30.30.3 (address of Designated Router)
Advertising Router: 192.30.30.3
LS Seq Number: 8000000f
Checksum: 0xe864
Length: 32
Network Mask: /24
    Attached Router: 192.30.30.2
    Attached Router: 192.30.30.3
```

Figure 36-10: Example output from the `show ip ospf database network` command

```

      OSPF Router process 200 with ID (192.30.30.2)
      Net Link States (Area 0.0.0.0)
LS age: 1175
Options: 0x2 (*|---|---|E|-)
LS Type: network-LSA
Link State ID: 192.10.10.9 (address of Designated Router)
Advertising Router: 192.30.30.3
LS Seq Number: 80000002
Checksum: 0xdfb1
Length: 32
Network Mask: /24
    Attached Router: 192.20.20.1
    Attached Router: 192.30.30.3
LS age: 1327
Options: 0x2 (*|---|---|E|-)
LS Type: network-LSA
Link State ID: 192.20.20.2 (address of Designated Router)
Advertising Router: 192.20.20.2
LS Seq Number: 8000000d
Checksum: 0xbce6
Length: 32
Network Mask: /24
    Attached Router: 192.20.20.1
    Attached Router: 192.20.20.2
LS age: 1278
Options: 0x2 (*|---|---|E|-)
LS Type: network-LSA
Link State ID: 192.30.30.3 (address of Designated Router)
Advertising Router: 192.30.30.3
Advertising Router: 192.30.30.3
LS Seq Number: 80000001
Checksum: 0x0556
Length: 32
Network Mask: /24
    Attached Router: 192.30.30.2
    Attached Router: 192.30.30.3
LS age: 1436
Options: 0x2 (*|---|---|E|-)
LS Type: network-LSA
Link State ID: 192.40.40.2 (address of Designated Router)
Advertising Router: 192.20.20.2
LS Seq Number: 8000000e
Checksum: 0xf173
Length: 32
Network Mask: /24
    Attached Router: 192.20.20.2
    Attached Router: 192.30.30.2

```

show ip ospf database nssa-external

Use this command to display information about the NSSA external LSAs.

For information on output options, see [“Controlling “show” Command Output” on page 1.35.](#)

Syntax `show ip ospf database nssa-external [<ip-address>]
[self-originate|<advrouter>]`

Parameter	Description
<advrouter>	adv-router <ip-address>
adv-router	Displays all the LSAs of the specified router.
<ip-address>	A link state ID, as an IP address.
self-originate	Displays self-originated link states.

Mode User Exec and Privileged Exec

Examples

```
awplus# show ip ospf database nssa-external 1.2.3.4 self-
originate

awplus# show ip ospf database nssa-external self-originate

awplus# show ip ospf database nssa-external 1.2.3.4 adv-
router 2.3.4.5
```

Output **Figure 36-11: Example output from the show ip ospf database nssa-external adv-router command**

```

      OSPF Router process 100 with ID (10.10.11.50)
          NSSA-external Link States (Area 0.0.0.0)
          NSSA-external Link States (Area 0.0.0.1 [NSSA])
LS age: 78
Options: 0x0 (*|---|---|---|)
LS Type: AS-NSSA-LSA
Link State ID: 0.0.0.0 (External Network Number For NSSA)
Advertising Router: 10.10.11.50
LS Seq Number: 80000001
Checksum: 0xc9b6
Length: 36
Network Mask: /0
    Metric Type: 2 (Larger than any link state path)
    TOS: 0
    Metric: 1
    NSSA: Forward Address: 0.0.0.0
--More--
      OSPF Router process 100 with ID (10.10.11.50)
          NSSA-external Link States (Area 0.0.0.0)
          NSSA-external Link States (Area 0.0.0.1 [NSSA])
LS age: 78
Options: 0x0 (*|---|---|---|)
LS Type: AS-NSSA-LSA
Link State ID: 0.0.0.0 (External Network Number For NSSA)
Advertising Router: 10.10.11.50
LS Seq Number: 80000001
Checksum: 0xc9b6
Length: 36
Network Mask: /0
    Metric Type: 2 (Larger than any link state path)
    TOS: 0
    Metric: 1
    NSSA: Forward Address: 0.0.0.0
    External Route Tag: 0
          NSSA-external Link States (Area 0.0.0.1 [NSSA])
```

show ip ospf database opaque-area

Use this command to display information about the area-local (link state type 10) scope LSAs. Type-10 Opaque LSAs are not flooded beyond the borders of their associated area.

For information on output options, see [“Controlling “show” Command Output” on page 1.35.](#)

Syntax `show ip ospf database opaque-area [<ip-address>]
[self-originate|<advrouter>]`

Parameter	Description
<advrouter>	adv-router <ip-address>
adv-router	Displays all the LSAs of the specified router.
<ip-address>	A link state ID, as an IP address.
self-originate	Displays self-originated link states.

Mode User Exec and Privileged Exec

Examples

```
awplus# show ip ospf database opaque-area 1.2.3.4 self-originate
awplus# show ip ospf database opaque-area self-originate
awplus# show ip ospf database opaque-area 1.2.3.4 adv-router 2.3.4.5
```

Output Figure 36-12: Example output from the `show ip ospf database opaque-area` command

```
OSPF Router process 100 with ID (10.10.11.50)
      Area-Local Opaque-LSA (Area 0.0.0.0)
LS age: 262
Options: 0x2 (*|---|E|)
LS Type: Area-Local Opaque-LSA
Link State ID: 10.0.25.176 (Area-Local Opaque-Type/ID)
Opaque Type: 10
Opaque ID: 6576
Advertising Router: 10.10.11.50
LS Seq Number: 80000001
Checksum: 0xb413
Length: 26
```

show ip ospf database opaque-as

Use this command to display information about the link-state type 11 LSAs. This type of link-state denotes that the LSA is flooded throughout the Autonomous System (AS).

For information on output options, see [“Controlling “show” Command Output” on page 1.35.](#)

Syntax `show ip ospf database opaque-as [<ip-address>]
[self-originate|<advrouter>]`

Parameter	Description
<advrouter>	adv-router <ip-address>
adv-router	Displays all the LSAs of the specified router.
<ip-address>	A link state ID, as an IP address.
self-originate	Displays self-originated link states.

Mode User Exec and Privileged Exec

Examples

```
awplus# show ip ospf database opaque-as 1.2.3.4 self-originate

awplus# show ip ospf database opaque-as self-originate

awplus# show ip ospf database opaque-as 1.2.3.4 adv-router 2.3.4.5
```

Output [Figure 36-13: Example output from the show ip ospf database opaque-as command](#)

```
OSPF Router process 100 with ID (10.10.11.50)
AS-Global Opaque-LSA
LS age: 325
Options: 0x2 (*|-|-|-|-|E|-)
LS Type: AS-external Opaque-LSA
Link State ID: 11.10.9.23 (AS-external Opaque-Type/ID)
Opaque Type: 11
Opaque ID: 657687
Advertising Router: 10.10.11.50
LS Seq Number: 80000001
Checksum: 0xb018
Length: 25
```

show ip ospf database opaque-link

Use this command to display information about the link-state type 9 LSAs. This type denotes a link-local scope. The LSAs are not flooded beyond the local network.

For information on output options, see [“Controlling “show” Command Output” on page 1.35.](#)

Syntax `show ip ospf database opaque-link [<ip-address>]
[self-originate|<advrouter>]`

Parameter	Description
<advrouter>	adv-router <ip-address>
adv-router	Displays all the LSAs of the specified router.
<ip-address>	A link state ID, as an IP address.
self-originate	Displays self-originated link states.

Mode User Exec and Privileged Exec

Examples

```
awplus# show ip ospf database opaque-link 1.2.3.4 self-originate

awplus# show ip ospf database opaque-link self-originate

awplus# show ip ospf database opaque-link 1.2.3.4 adv-router 2.3.4.5
```

Output Figure 36-14: Example output from the `show ip ospf database opaque-link` command

```

      OSPF Router process 100 with ID (10.10.11.50)
          Link-Local Opaque-LSA (Link hme0:10.10.10.50)
LS age: 276
Options: 0x2 (*|---|E|)
LS Type: Link-Local Opaque-LSA
Link State ID: 10.0.220.247 (Link-Local Opaque-Type/ID)
Opaque Type: 10
Opaque ID: 56567
Advertising Router: 10.10.11.50
LS Seq Number: 80000001
Checksum: 0x744e
Length: 26
          Link-Local Opaque-LSA (Link hme1:10.10.11.50)
```

show ip ospf database router

Use this command to display information only about the router LSAs.

For information on output options, see “Controlling “show” Command Output” on page 1.35.

Syntax `show ip ospf database router [<ip-address>]
[self-originate|<advrouter>]`

Parameter	Description
<advrouter>	adv-router <ip-address>
adv-router	Displays all the LSAs of the specified router.
<ip-address>	A link state ID, as an IP address.
self-originate	Displays self-originated link states.

Mode User Exec and Privileged Exec

Examples

```
awplus# show ip ospf database router 1.2.3.4 self-originate  
awplus# show ip ospf database router self-originate  
awplus# show ip ospf database router 1.2.3.4 adv-router  
2.3.4.5
```

Output Figure 36-15: Example output from the `show ip ospf database router` command

```
      OSPF Router process 100 with ID (10.10.11.50)
      Router Link States (Area 0.0.0.0)
LS age: 878
Options: 0x2 (*|---|E|)
Flags: 0x3 : ABR ASBR
LS Type: router-LSA
Link State ID: 10.10.11.50
Advertising Router: 10.10.11.50
LS Seq Number: 80000004
Checksum: 0xe39e
Length: 36
  Number of Links: 1
    Link connected to: Stub Network
      (Link ID) Network/subnet number: 10.10.10.0
      (Link Data) Network Mask: 255.255.255.0
      Number of TOS metrics: 0
      TOS 0 Metric: 10
      Router Link States (Area 0.0.0.1)
LS age: 877
Options: 0x2 (*|---|E|)
Flags: 0x3 : ABR ASBR
LS Type: router-LSA
Link State ID: 10.10.11.50
Advertising Router: 10.10.11.50
LS Seq Number: 80000003
Checksum: 0xee93
Length: 36
  Number of Links: 1
    Link connected to: Stub Network
      (Link ID) Network/subnet number: 10.10.11.0
      (Link Data) Network Mask: 255.255.255.0
      Number of TOS metrics: 0
      TOS 0 Metric: 10
```

show ip ospf database summary

Use this command to display information about the summary LSAs.

For information on output options, see “Controlling “show” Command Output” on page 1.35.

Syntax `show ip ospf database summary [<ip-address>]
[self-originate|<advrouter>]`

Parameter	Description
<advrouter>	adv-router <ip-address>
adv-router	Displays all the LSAs of the specified router.
<ip-address>	A link state ID, as an IP address.
self-originate	Displays self-originated link states.

Mode User Exec and Privileged Exec

Examples

```
awplus# show ip ospf database summary 1.2.3.4 self-originate
awplus# show ip ospf database summary self-originate
awplus# show ip ospf database summary 1.2.3.4 adv-router
2.3.4.5
```

Output Figure 36-16: Example output from the `show ip ospf database summary` command

```

      OSPF Router process 100 with ID (10.10.11.50)
          Summary Link States (Area 0.0.0.0)
          Summary Link States (Area 0.0.0.1)
LS age: 1124
Options: 0x2 (*|---|E|)
LS Type: summary-LSA
Link State ID: 10.10.10.0 (summary Network Number)
Advertising Router: 10.10.11.50
LS Seq Number: 80000001
Checksum: 0x41a2
Length: 28
Network Mask: /24
      TOS: 0  Metric: 10
```

Figure 36-17: Example output from the `show ip ospf database summary self-originate` command

```

        OSPF Router process 100 with ID (10.10.11.50)
          Summary Link States (Area 0.0.0.0)
LS age: 1061
Options: 0x2 (*|---|E|)
LS Type: summary-LSA
Link State ID: 10.10.11.0 (summary Network Number)
Advertising Router: 10.10.11.50
LS Seq Number: 80000001
Checksum: 0x36ac
Length: 28
Network Mask: /24
      TOS: 0  Metric: 10
          Summary Link States (Area 0.0.0.1)
LS age: 1061
Options: 0x2 (*|---|E|)
LS Type: summary-LSA
Link State ID: 10.10.11.0 (summary Network Number)
Advertising Router: 10.10.11.50
LS Seq Number: 80000001
Checksum: 0x36ac
Length: 28
Network Mask: /24
      TOS: 0  Metric: 10
          Summary Link States (Area 0.0.0.1)
LS age: 1061
Options: 0x2 (*|---|E|)
LS Type: summary-LSA
Link State ID: 10.10.10.0 (summary Network Number)
Advertising Router: 10.10.11.50
LS Seq Number: 80000001
Checksum: 0x41a2
Length: 28
Network Mask: /24
      TOS: 0  Metric: 10

```

Figure 36-18: Example output from the `show ip ospf database summary adv-router <ip-address>` command

```

        OSPF Router process 100 with ID (10.10.11.50)
          Summary Link States (Area 0.0.0.0)
LS age: 989
Options: 0x2 (*|---|E|)
LS Type: summary-LSA
Link State ID: 10.10.11.0 (summary Network Number)
Advertising Router: 10.10.11.50
LS Seq Number: 80000001
Checksum: 0x36ac
Length: 28
Network Mask: /24
      TOS: 0  Metric: 10
          Summary Link States (Area 0.0.0.1)
LS age: 989
Options: 0x2 (*|---|E|)
LS Type: summary-LSA
Link State ID: 10.10.11.0 (summary Network Number)
Advertising Router: 10.10.11.50
LS Seq Number: 80000001
Checksum: 0x36ac
Length: 28
Network Mask: /24
      TOS: 0  Metric: 10

```

show ip ospf interface

Use this command to display interface information for OSPF.

For information on output options, see [“Controlling “show” Command Output” on page 1.35.](#)

Syntax `show ip ospf interface <interface-name>`

Parameter	Description
<code><interface-name></code>	An alphanumeric string that is the interface name.

Mode User Exec and Privileged Exec

Examples

```
awplus# show ip ospf interface port1.0.2
```

Output [Figure 36-19: Example output from the show ip ospf interface command](#)

```
vlan2 is up, line protocol is up
  Internet Address 1.1.1.1/24, Area 0.0.0.0, MTU 1500
  Process ID 0, Router ID 33.33.33.33, Network Type BROADCAST,
  Cost: 10
  Transmit Delay is 1 sec, State Waiting, Priority 1, TE Metric 0
  No designated router on this network
  No backup designated router on this network
  Timer intervals configured, Hello 10, Dead 40, Wait 40,
  Retransmit 5
  Hello due in 00:00:02
  Neighbor Count is 0, Adjacent neighbor count is 0
  Crypt Sequence Number is 1106347721
  Hello received 0 sent 1, DD received 0 sent 0
  LS-Req received 0 sent 0, LS-Upd received 0 sent 0
  LS-Ack received 0 sent 0, Discarded 0
```

show ip ospf neighbor

Use this command to display information on OSPF neighbors. Include the process ID parameter with this command to display information about specified instances.

For information on output options, see [“Controlling “show” Command Output” on page 1.35.](#)

Syntax

```
show ip ospf [<ospf-id>] neighbor <ip-addr> [detail]
show ip ospf [<ospf-id>] neighbor detail [all]
show ip ospf [<ospf-id>] neighbor [all]
show ip ospf [<ospf-id>] neighbor interface <ip-addr>
```

Parameter	Description
<ospf-id>	<0-65535> The ID of the router process for which information will be displayed.
<ip-addr>	The Neighbor ID, entered as an IP address.
all	Include downstatus neighbor
detail	Detail of all neighbors
interface <ip-addr>	IP address of the interface.

Mode User Exec and Privileged Exec

Examples

```
awplus# show ip ospf neighbor detail
awplus# show ip ospf neighbor 1.2.3.4
awplus# show ip ospf neighbor interface 10.10.10.50 detail
all
```

Output Figure 36-20: Example output from the `show ip ospf neighbor` command

```
OSPF process 1:
Neighbor ID    Pri   State           Dead Time   Address      Interface
10.10.10.50    1     Full/DR         00:00:38   10.10.10.50  vlan1
OSPF process 100:
Neighbor ID    Pri   State           Dead Time   Address      Interface
10.10.11.50    1     Full/Backup     00:00:31   10.10.11.50  vlan2
awplus#show ip ospf 1 neighbor
OSPF process 1:
Neighbor ID    Pri   State           Dead Time   Address      Interface
10.10.10.50    1     Full/DR         00:00:38   10.10.10.50  vlan1
```

Figure 36-21: Example output from the `show ip ospf <ospf-id> neighbor` command

```
OSPF process 100:
Neighbor ID      Pri   State           Dead Time   Address      Interface
10.10.11.50     1     Full/Backup     00:00:31   10.10.11.50  vlan2
```

Figure 36-22: Example output from the `show ip ospf neighbor detail` command

```
Neighbor 10.10.10.50, interface address 10.10.10.50
  In the area 0.0.0.0 via interface vlan5
  Neighbor priority is 1, State is Full, 5 state changes
  DR is 10.10.10.50, BDR is 10.10.10.10
  Options is 0x42 (*|O|-|-|-|E|-)
  Dead timer due in 00:00:38
  Neighbor is up for 00:53:07
  Database Summary List 0
  Link State Request List 0
  Link State Retransmission List 0
  Crypt Sequence Number is 0
  Thread Inactivity Timer on
  Thread Database Description Retransmission off
  Thread Link State Request Retransmission off
  Thread Link State Update Retransmission on
Neighbor 10.10.11.50, interface address 10.10.11.50
  In the area 0.0.0.0 via interface vlan2
  Neighbor priority is 1, State is Full, 5 state changes
  DR is 10.10.11.10, BDR is 10.10.11.50
  Options is 0x42 (*|O|-|-|-|E|-)
  Dead timer due in 00:00:31
  Neighbor is up for 00:26:50
  Database Summary List 0
  Link State Request List 0
  Link State Retransmission List 0
  Crypt Sequence Number is 0
  Thread Inactivity Timer on
  Thread Database Description Retransmission off
  Thread Link State Request Retransmission off
  Thread Link State Update Retransmission on
```

show ip ospf route

Use this command to display the OSPF routing table. Include the `process ID` parameter with this command to display the OSPF routing table for specified instances.

For information on output options, see [“Controlling “show” Command Output” on page 1.35.](#)

Syntax `show ip ospf [<ospf-id>] route`

Parameter	Description
<code><ospf-id></code>	<code><0-65535></code> The ID of the router process for which information will be displayed. If this parameter is included, only the information for this specified routing process is displayed.

Mode User Exec and Privileged Exec

Examples To display the OSPF routing table, use the command:

```
awplus# show ip ospf route
```

Output Figure 36-23: Example output from the `show ip ospf route` command for a specific process

```
OSPF process 1:
Codes: C - connected, D - Discard, O - OSPF, IA - OSPF inter area
       N1 - OSPF NSSA external type 1, N2 - OSPF NSSA external type 2
       E1 - OSPF external type 1, E2 - OSPF external type 2
O 10.10.0.0/24 [10] is directly connected, vlan1, Area 0.0.0.0
O 10.10.11.0/24 [10] is directly connected, vlan2, Area 0.0.0.0
O 10.10.11.100/32 [10] is directly connected, lo, Area 0.0.0.0
E2 10.15.0.0/24 [10/50] via 10.10.0.1, vlan1
IA 172.16.10.0/24 [30] via 10.10.11.50, vlan2, Area 0.0.0.0
E2 192.168.0.0/16 [10/20] via 10.10.11.50, vlan2
```

show ip ospf virtual-links

Use this command to display virtual link information.

For information on output options, see “Controlling “show” Command Output” on page 1.35.

Syntax show ip ospf virtual-links

Mode User Exec and Privileged Exec

Examples To display virtual link information, use the command:

```
awplus# show ip ospf virtual-links
```

Output Figure 36-24: Example output from the `show ip ospf virtual-links` command

```
Virtual Link VLINK0 to router 10.10.0.9 is up
  Transit area 0.0.0.1 via interface vlan5
  Transmit Delay is 1 sec, State Point-To-Point,
  Timer intervals configured, Hello 10, Dead 40, Wait 40,
  Retransmit 5
  Hello due in 00:00:02
  Adjacency state Full
Virtual Link VLINK1 to router 10.10.0.123 is down
  Transit area 0.0.0.1 via interface *
  Transmit Delay is 1 sec, State Down,
  Timer intervals configured, Hello 10, Dead 40, Wait 40,
  Retransmit 5
  Hello due in inactive
  Adjacency state Down
```

show ip protocols ospf

Use this command to display OSPF process parameters and statistics.

For information on output options, see ["Controlling "show" Command Output"](#) on page 1.35.

Syntax show ip protocols ospf

Mode User Exec and Privileged Exec

Examples To display OSPF process parameters and statistics, use the command:

```
awplus# show ip protocols ospf
```

Output Figure 36-25: Example output from the `show ip protocols ospf` command

```
Routing Protocol is "ospf 200"
  Invalid after 0 seconds, hold down 0, flushed after 0
  Outgoing update filter list for all interfaces is
    Redistributed kernel filtered by filter1
  Incoming update filter list for all interfaces is
  Redistributing: kernel
  Routing for Networks:
    192.30.30.0/24
    192.40.40.0/24
  Routing Information Sources:
    Gateway         Distance         Last Update
  Distance: (default is 110)
    Address          Mask             Distance List
```

summary-address

Use this command to suppress external routes that have the specified address range.

Use the **no** variant of this command to allow external routes that have the specified address range.

Syntax `summary-address <ip-addr/prefix-length> [not-advertise]
[tag <0-4294967295>]`

`no summary-address <ip-addr/prefix-length> [not-advertise]
[tag <0-4294967295>]`

Parameter	Description
<code><ip-addr/prefix-length></code>	The range of addresses given as IPv4 starting address and a prefix length.
<code>not-advertise</code>	Suppresses external routes.
<code>tag <0-4294967295></code>	The default tag value is 0.

Default The default tag value for a summary address is 0.

Mode Router Configuration

Usage An address range is a pairing of an address and a mask that is almost the same as IP network number. For example, if the specified address range is 192.168.0.0/255.255.240.0, it matches: 192.168.1.0/24, 192.168.4.0/22, 192.168.8.128/25 and so on.

Redistributing routes from other protocols into OSPF requires the router to advertise each route individually in an external LSA. Use the **summary address** command to advertise one summary route for all redistributed routes covered by a specified network address and mask. This helps decrease the size of the OSPF link state database.

Examples The following example uses the **summary-address** command to aggregate external LSAs that match the network 172.16.0.0/16 and assign a Tag value of 3.

```
awplus# configure terminal
awplus(config)# router ospf 100
awplus(config-router)# summary-address 172.16.0.0/16 tag 3
```

timers spf

Use this command to adjust route calculation timers.

Use the **no** variant of this command to return to the default timer values.

Syntax `timers spf <spf-delay> <spf-holdtime>`
`no timers spf`

Parameter	Description
<code><spf-delay></code>	<code><0-2147483647></code> Specifies the delay between receiving changed routing information and embarking on an SPF calculation.
<code><spf-holdtime></code>	<code><0-2147483647></code> Specifies the hold time between consecutive SPF calculations.

Default The default spf-delay value is 5 seconds. The default spf-holdtime value is 10 seconds.

Mode Router Configuration

Usage This command configures the delay time between the receipt of a topology change and the calculation of the Shortest Path First (SPF). This command also configures the hold time between two consecutive SPF calculations.

Examples

```
awplus# configure terminal
awplus(config)# router ospf 100
awplus(config-router)# timers spf 7 12
```

Related Commands [timers spf exp](#)

timers spf exp

Use this command to adjust route calculation timers using exponential back-off delays.

Use **no** form of this command to return to the default exponential back-off timer values.

Syntax `timers spf exp <min-holdtime> <max-holdtime>`
`no timers spf exp <min-holdtime> <max-holdtime>`

Parameter	Description
<code><min-holdtime></code>	<code><0-2147483647></code> Specifies the minimum delay between receiving a change to the SPF calculation in milliseconds. The default SPF min-holdtime value is 50 milliseconds.
<code><max-holdtime></code>	<code><0-2147483647></code> Specifies the maximum delay between receiving a change to the SPF calculation in milliseconds. The default SPF max-holdtime value is 50 seconds.

Mode Router Configuration

Usage This command configures the minimum and maximum delay time between the receipt of a topology change and the calculation of the Shortest Path First (SPF).

Examples To set the minimum delay time to 5 milliseconds and maximum delay time to 10 milliseconds, use the commands:

```
awplus# configure terminal
awplus(config)# router ospf 100
awplus(config-router)# timers spf exp 5 10
```

Related Commands [timers spf](#)

undebg ospf events

This command applies the functionality of the `no debug ospf events` command on page 36.17.

undebg ospf ifsm

This command applies the functionality of the `no debug ospf ifsm` command on page 36.18.

undebg ospf lsa

This command applies the functionality of the `no debug ospf lsa` command on page 36.19.

undebg ospf n fsm

This command applies the functionality of the `no debug ospf n fsm` command on page 36.20.

undebg ospf nsm

This command applies the functionality of the `no debug ospf nsm` command on page 36.21.

undebg ospf packet

This command applies the functionality of the `no debug ospf packet` command on page 36.22.

undebg ospf route

This command applies the functionality of the `no debug ospf route` command on page 36.23.

Chapter 37: BGP Configuration



Introduction.....	37.2
Enabling BGP Peers In The Same Autonomous System.....	37.2
Enabling BGP Between Different Autonomous Systems.....	37.3
Route Reflector.....	37.5
Confederations.....	37.7
BGP Authentication.....	37.10
Configuring BGP Graceful Reset.....	37.12
Configuring BGP Graceful Restart.....	37.14

Introduction

This chapter contains basic BGP configuration examples. For details about the commands used in these examples, or the outputs from validation commands, see [Chapter 38, BGP Commands](#).

Enabling BGP Peers In The Same Autonomous System

This example shows the minimum configuration required for enabling BGP on an interface. Peer 1 and Peer 2 are two BGP Peers belonging to the same Autonomous System (AS), AS200, connecting to network 10.10.10.0/24. First, define the routing process and the AS number to which the peers belong. Then, define BGP neighbors to start exchanging routing updates.

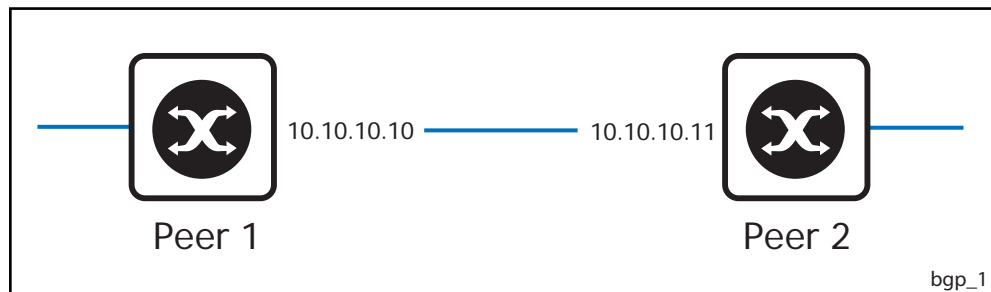

Peer 1

```

awplus#
configure terminal Enter the Global Configuration mode.

awplus(config)#
router bgp 200 Define the routing process. The number 200 specifies the AS
number of Peer 1.

awplus(config-router)#
neighbor 10.10.10.11 remote-as 200 Define BGP neighbors. 10.10.10.11 is the IP address of the
neighbor (Peer 2) and 200 is the neighbor's AS number.

```

Peer 2

```

awplus#
configure terminal Enter the Global Configuration mode

awplus(config)#
router bgp 200 Define the routing process. The number 200 specifies the AS
number of Peer 2.

awplus(config-router)#
neighbor 10.10.10.10 remote-as 200 Define BGP neighbors. 10.10.10.10 is the IP address of the
neighbor (Peer 1) and 200 is the neighbor's AS number.

```

Names of Commands Used

```
router bgp
neighbor remote-as
```

Validation Commands

```
show ip bgp summary
show ip bgp neighbors
```

Enabling BGP Between Different Autonomous Systems

This example shows the minimum configuration required for enabling BGP on an interface when the BGP peers belong to different Autonomous Systems (ASs). Peer 1 and Peer 2 are two BGP peers in different ASs, AS200 and AS300 connecting to network 10.10.10.0/24.

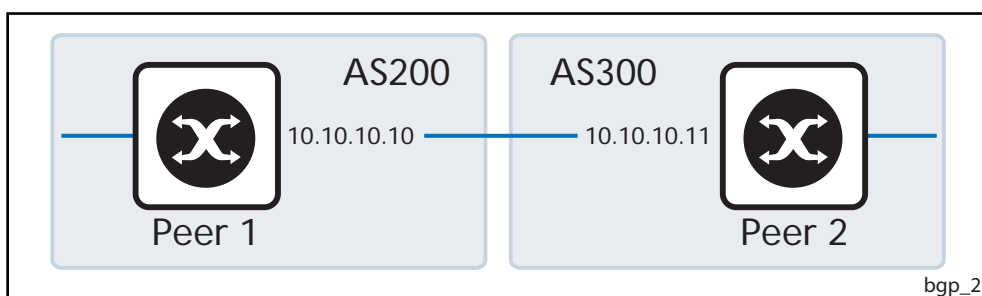

Peer 1

```
awplus#
configure terminal Enter the Global Configuration mode.
awplus(config)#
router bgp 200 Define the routing process. The number 200 specifies the AS
number of Peer 1.
awplus(config-router)#
neighbor 10.10.10.11 remote-as 300 Define BGP neighbors. 10.10.10.11 is the IP address of the
neighbor (Peer 2) and 300 is the neighbor's AS number.
```

Peer 2

```
awplus#
configure terminal Enter the Global Configuration mode.
awplus(config)#
router bgp 300 Define the routing process. The number 300 specifies the AS
number of Peer 2.
awplus(config-router)#
neighbor 10.10.10.10 remote-as 200 Define BGP neighbors. 10.10.10.10 is the IP address of the
neighbor (Peer 1) and 200 is the neighbor's AS number.
```

Names of Commands Used

```
router bgp  
neighbor remote-as
```

Validation Commands

```
show ip bgp summary  
show ip bgp neighbors
```

Route Reflector

Use Route Reflector to reduce the iBGP mesh inside an AS. In this example, Peer 2, Peer 5 and Peer 4 would have to maintain a full mesh among themselves but by making Peer 5 the Route Reflector, Peer 2 (Client1) has an iBGP session with the Route Reflector only and not with Peer 4 (Client 2). The routes learned from Peer 2 are advertised to the other clients and to iBGP peers outside the cluster; the iBGP routes learned from iBGP peers outside the cluster are advertised to Peer 2. This reduces the iBGP peer connections in AS1.

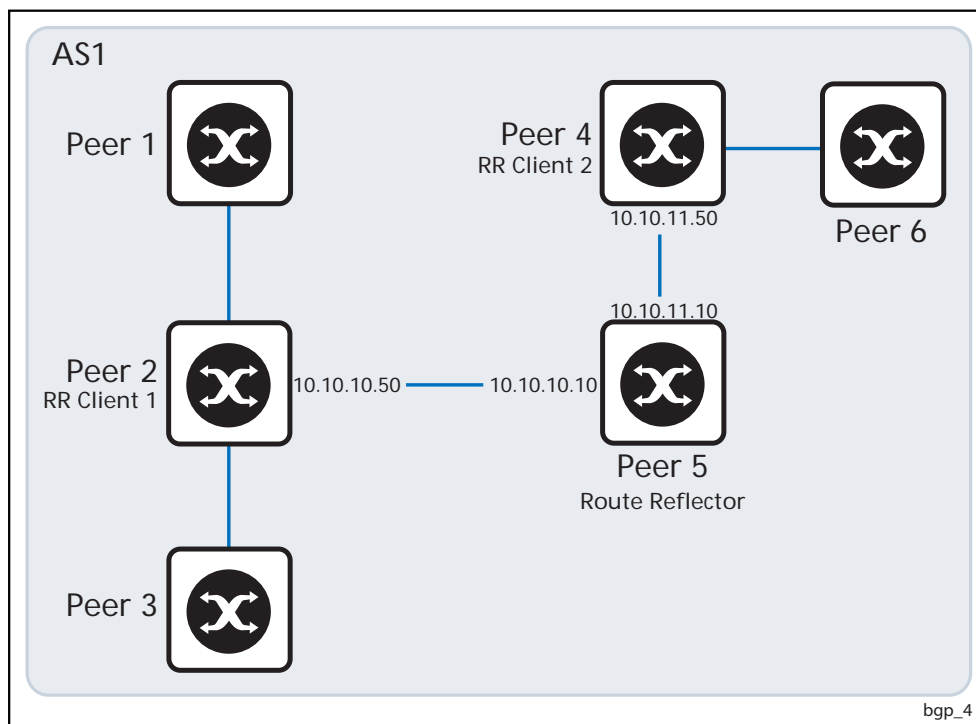

Route Reflector (Peer 5)

<code>awplus#</code>	
<code>configure terminal</code>	Enter the Global Configuration mode.
<code>awplus(config)#</code>	
<code>router bgp 1</code>	Define the routing process. The number 1 specifies the AS number of Peer 5.
<code>awplus(config-router)#</code>	
<code>neighbor 10.10.10.50 remote-as 1</code>	Define BGP neighbors. 10.10.10.50 is the IP address of one of the neighbors (Peer 2) and 1 is the neighbor's AS number.
<code>awplus(config-router)#</code>	
<code>neighbor 10.10.10.50 route-reflector client</code>	Configure Peer 5 as the Route-Reflector (RR) and neighbor Peer 2 as its client.
<code>awplus(config-router)#</code>	
<code>neighbor 10.10.11.50 remote-as 1</code>	Define BGP neighbor. 10.10.11.50 is the IP address of one of the neighbors (Peer 4) and 1 is the neighbor's AS number.
<code>awplus(config-router)#</code>	
<code>neighbor 10.10.11.50 route-reflector client</code>	Configure Peer 5 as the Route-Reflector (RR) and neighbor Peer 4 as its client.

Route Reflector Client 1 (Peer 2)

```
awplus(config)#
```

```
router bgp 1
```

 Define the routing process. The number 1 specifies the AS number of Peer 2.

```
awplus(config-router)#
```

```
neighbor 10.10.10.10 remote-as 1
```

 Define BGP neighbors. 10.10.10.10 is the IP address of the neighbor (Peer 5) and 1 is the neighbor's AS number.

Route Reflector Client 2 (Peer 4)

```
awplus(config)#
```

```
router bgp 1
```

 Define the routing process. The number 1 specifies the AS number of Peer 4.

```
awplus(config-router)#
```

```
neighbor 10.10.11.10 remote-as 1
```

 Define BGP neighbors. 10.10.11.10 is the IP address of the neighbor (Peer 5) and 1 is the neighbor's AS number.

Names of Commands Used

```
neighbor remote-as  
neighbor route-reflector-client
```

Validation Commands

```
show ip bgp  
show ip bgp neighbors
```

Confederations

In this example, AS1 contains three Confederation Autonomous Systems - AS 1000, AS 1001 and AS 1002. To any outside AS, the Confederation is a single AS. AS1 Confederation eBGP is run between Peer 2 and Peer 5, and between Peer 5 and Peer 7. Peer 2 is configured so that its local AS is 1000. Its peer connection to Peer 5 is set up like any other eBGP session. The [bgp confederation identifier command on page 38.17](#) tells the peer that it is a member of a Confederation and the Confederation ID. The [bgp confederation peers command on page 38.18](#) lists the member AS to which Peer 2 is connected. The command tells the BGP process that the eBGP connection is a Confederation eBGP rather than a normal eBGP.

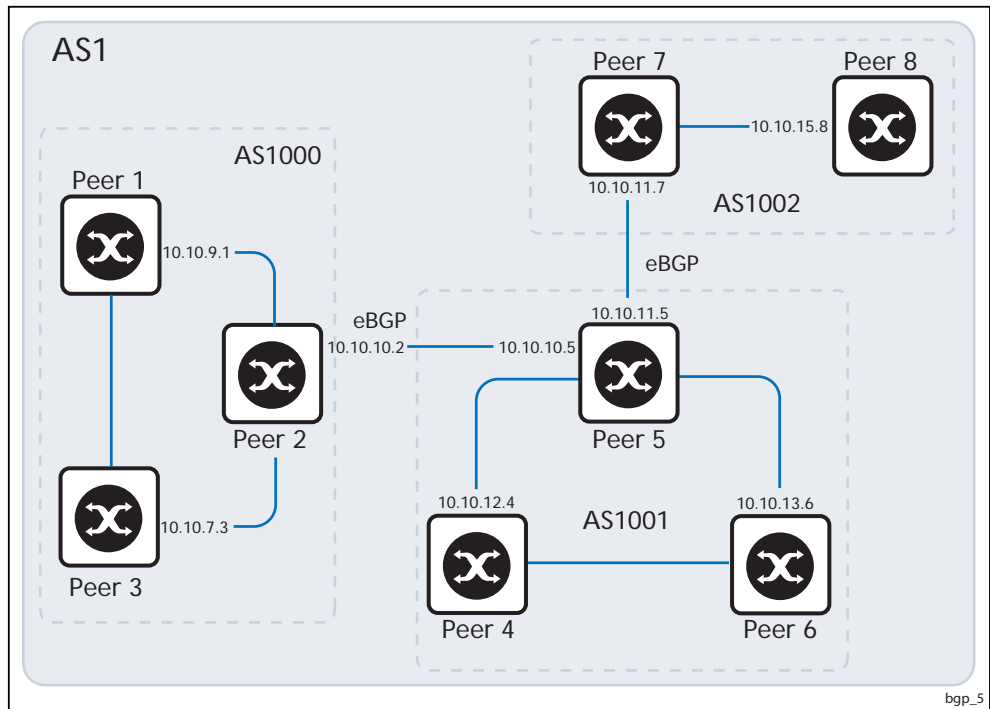

Peer 2

```

awplus#
configure terminal Enter the Global Configuration mode.

awplus(config)#
router bgp 1000 Define the routing process. The number 1000 specifies the AS
number of Peer 2.

awplus(config-router)#
bgp confederation identifier 1 Specify BGP Confederation Identifier. To routers outside the
confederation, the whole confederation will appear as a single
AS, and the identifier will appear as its AS number.

awplus(config-router)#
bgp confederation peers 1001 1002 Specify 1001 (AS1001) and 1002 (AS1002) to become
members of the Confederation.
    
```

Peer 2 (cont.)

```

awplus(config-router)#
neighbor 10.10.10.5 remote-as 1001 Define BGP neighbors for Peer 2 by specifying the IP addresses
awplus(config-router)# and the AS numbers of neighbors.
neighbor 10.10.9.1 remote-as 1000
awplus(config-router)#
neighbor 10.10.7.3 remote-as 1000

```

Peer 5

```

awplus(config)#
router bgp 1001 Define the routing process. The number 1001 specifies the AS
number of Peer 5.

```

```

awplus(config-router)#
bgp confederation identifier 1 Specify BGP Confederation Identifier. To routers outside the
confederation, the whole confederation will appear as a single
AS, and the identifier will appear as its AS number.

```

```

awplus(config-router)#
bgp confederation peers 1000 1002 Specify 1000 (AS1000) and 1002 (AS1002) to become
members of the Confederation.

```

```

awplus(config-router)#
neighbor 10.10.10.2 remote-as 1000 Define BGP neighbors for Peer 5 by specifying the IP addresses
awplus(config-router)# and the AS numbers of neighbors.
neighbor 10.10.11.7 remote-as 1002
awplus(config-router)#
neighbor 10.10.13.6 remote-as 1001
awplus(config-router)#
neighbor 10.10.12.4 remote-as 1001

```

Peer 7

```

awplus(config)#
router bgp 1002 Define the routing process. The number 1001 specifies the
AS number of Peer 5.

```

```

awplus(config-router)#
bgp confederation identifier 1 Specify BGP Confederation Identifier. To routers outside the
confederation, the whole confederation will appear as a
single AS, and the identifier will appear as its AS number.

```

```

awplus(config-router)#
bgp confederation peers 1000 1001 Specify 1000 (AS1000) and 1001 (AS1001) to become
members of the Confederation.

```

```

awplus(config-router)#
neighbor 10.10.11.5 remote-as 1001 Define BGP neighbors for Peer 7 by specifying the IP
awplus(config-router)# addresses and the AS numbers of neighbors.
neighbor 10.10.15.8 remote-as 1002

```

Names of Commands Used

neighbor remote-as
bgp confederation peers
bgp confederation identifier

Validation Commands

show ip bgp
show ip bgp neighbors

BGP Authentication

BGP authentication allows users to receive selected routing information, enhancing security of their network traffic. When BGP authentication is enabled on a peer, the peer verifies routing packet it receives by exchanging a password that is configured on both the sending and the receiving peers.

In this example, both **Peer 1** and **Peer 2** have `manager` as the password. Configure the same password on all routers that are to communicate using BGP in a network.

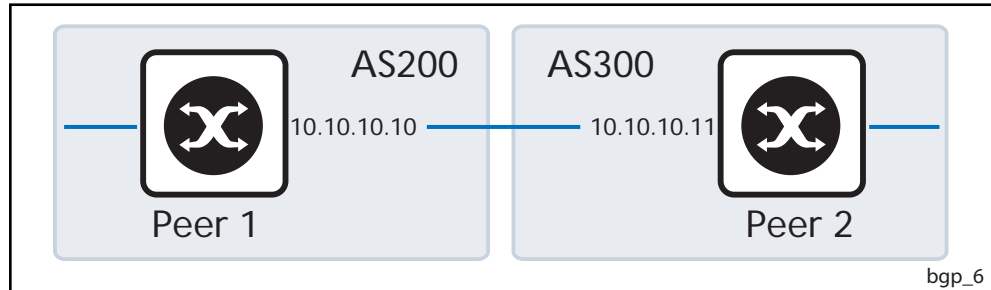

Peer 1

```
awplus(config)#
configure terminal  Enter the Global Configuration mode.
awplus(config-router)#
router bgp 200      Define the routing process. The number 200 specifies the
                   AS number of Peer 1.
awplus(config-router)#
neighbor 10.10.10.11 remote-as 200  Define BGP neighbors and establish a TCP session.
                                     10.10.10.11 is the IP address of the neighbor (Peer 2)
                                     and 200 is the neighbor's AS number.
awplus(config-router)#
neighbor 10.10.10.11 password 1     Specify the encryption type and the password.
                                manager
```

Peer 2

```
awplus(config)#
configure terminal  Enter the Global Configuration mode.
awplus(config-router)#
router bgp 200      Define the routing process.
                   The number 200 specifies the AS number of Peer 2.
awplus(config-router)#
neighbor 10.10.10.10 remote-as 200  Define BGP neighbors and establish a TCP session.
                                     10.10.10.10 is the IP address of the neighbor (Peer 1)
                                     and 200 is the neighbor's AS number.
awplus(config-router)#
neighbor 10.10.10.10 password 1     Specify the encryption type and the password.
                                manager
```

Names of Commands Used

neighbor remote-as
neighbor password

Validation Commands

show ip bgp
show ip bgp neighbors

Configuring BGP Graceful Reset

The graceful restart feature for BGP session reset is used so that any changes in network configuration do not affect packet forwarding. The [bgp graceful-restart graceful-reset command on page 38.28](#) invokes graceful restart only when a configuration change forces a peer reset.

This example shows configuring BGP graceful reset.

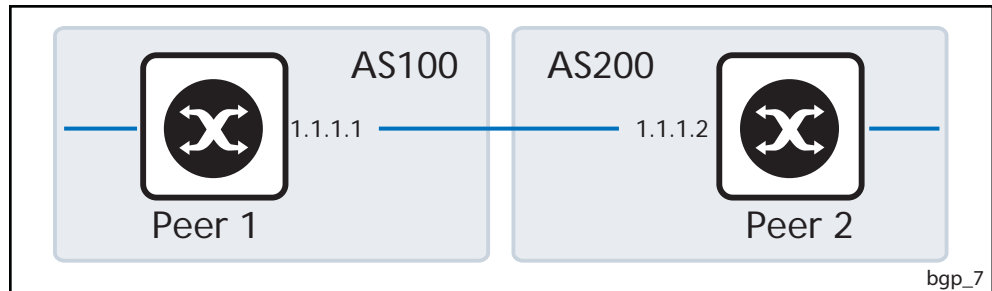

Peer 1

<code>awplus(config)#</code>	
<code>configure terminal</code>	Enter the Global Configuration mode.
<code>awplus(config-router)#</code>	
<code>router bgp 100</code>	Define the routing process. The number 100 specifies the AS number of Peer 1.
<code>awplus(config-router)#</code>	
<code>bgp graceful-restart</code>	Enable BGP graceful restart support.
<code>awplus(config-router)#</code>	
<code>bgp graceful-restart graceful-reset</code>	Configure to invoke graceful restart when a configuration change forces a peer reset.
<code>awplus(config-router)#</code>	
<code>neighbor 1.1.1.2 remote-as 200</code>	Specify the neighbor's IP address (1.1.1.2) and the AS number of the neighbor (200).
<code>awplus(config-router)#</code>	
<code>neighbor 1.1.1.2 capability graceful-restart</code>	Specify the neighbor's IP address (1.1.1.2) for which the graceful restart capability is supported.

Peer 2

<code>awplus(config)#</code>	
<code>configure terminal</code>	Enter the Global Configuration mode.
<hr/>	
<code>awplus(config-router)#</code>	
<code>router bgp 200</code>	Define the routing process. The number 200 specifies the AS number of Peer 2.
<hr/>	
<code>awplus(config-router)#</code>	
<code>bgp graceful-restart</code>	Enable BGP graceful restart support.
<hr/>	
<code>awplus(config-router)#</code>	
<code>bgp graceful-restart graceful-reset</code>	Configure to invoke graceful restart when a configuration change forces a peer reset.
<hr/>	
<code>awplus(config-router)#</code>	
<code>neighbor 1.1.1.1 remote-as 100</code>	Specify the neighbor's IP address (1.1.1.1) and the AS number of the neighbor (100).
<hr/>	
<code>awplus(config-router)#</code>	
<code>neighbor 1.1.1.1 capability graceful-restart</code>	Specify the neighbor's IP address (1.1.1.1) for which the graceful restart capability is supported

Names of Commands Used

```

bgp graceful-restart
bgp graceful-restart graceful-reset
neighbor capability graceful-restart
neighbor remote-as
neighbor restart-time
router bgp

```

Validation Commands

```

show ip bgp
show ip bgp neighbors
show ip bgp summary
show ip route
show ip route database

```

Configuring BGP Graceful Restart

Using BGP graceful restart, the data forwarding plane of the device can continue to process and forward packets even if the control plane, which is responsible for determining best paths, fails. The [bgp graceful-restart command on page 38.26](#) sets the maximum time that a graceful-restart neighbor waits to come back up after a restart. This value is applied to all neighbors unless you explicitly override it by configuring the corresponding value on the neighbor.

This example shows configuring BGP graceful restart.

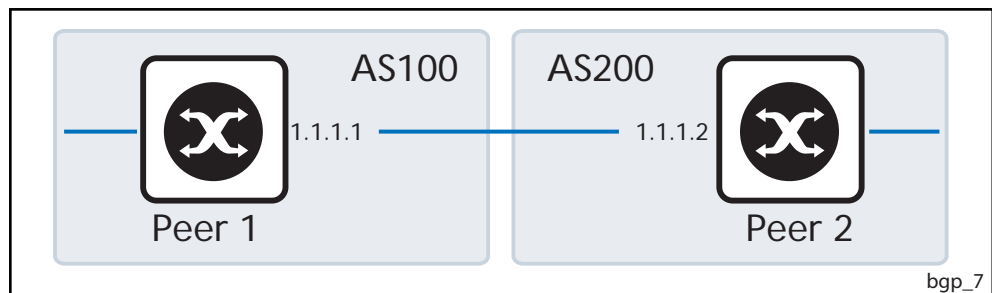

Peer 1

<code>awplus(config)#</code>	
<code>configure terminal</code>	Enter the Global Configuration mode.
<code>awplus(config-router)#</code>	
<code>router bgp 100</code>	Define the routing process. The number 100 specifies the AS number of Peer 1.
<code>awplus(config-router)#</code>	
<code>bgp graceful-restart restart-time 180</code>	Configure the maximum time in seconds (180) required for neighbor(s) to restart.
<code>awplus(config-router)#</code>	
<code>bgp graceful-restart restart-time 150</code>	Configure the maximum time in seconds (150) to retain stale paths from the restarting neighbor(s).
<code>awplus(config-router)#</code>	
<code>bgp update-delay 120</code>	Configure the maximum time in seconds (120) to defer initial route selection.
<code>awplus(config-router)#</code>	
<code>neighbor 1.1.1.2 remote-as 200</code>	Specify the neighbor's IP address (1.1.1.2) and the AS number of the neighbor (200).
<code>awplus(config-router)#</code>	
<code>neighbor 1.1.1.2 capability graceful-restart</code>	Specify the neighbor's IP address (1.1.1.2) for which the graceful restart capability is supported.

Peer 2

<code>awplus(config)#</code>	
<code>configure terminal</code>	Enter the Global Configuration mode.
<code>awplus(config-router)#</code>	
<code>router bgp 200</code>	Define the routing process. The number 200 specifies the AS number of Peer 2.
<code>awplus(config-router)#</code>	
<code>bgp graceful-restart</code>	Enable BGP graceful restart support. If the restart and stale-path timers are not configured, the defaults are 90 seconds and 360 seconds, respectively.
<code>awplus(config-router)#</code>	
<code>neighbor 1.1.1.1 remote-as 100</code>	Specify the neighbor's IP address (1.1.1.1) and the AS number of the neighbor (100).
<code>awplus(config-router)#</code>	
<code>neighbor 1.1.1.1 capability graceful-restart</code>	Specify the neighbor's IP address (1.1.1.1) for which the graceful restart capability is supported
<code>awplus(config-router)#</code>	
<code>neighbor 1.1.1.1 restart-time 160</code>	Configure the maximum time in seconds (160) required for the neighbor to restart. This overwrites the configured restart time for that neighbor. For example: the above configured restart-time for all neighbors is 90 seconds (the default). With this command, the neighbor, 1.1.1.1, will have a 160 second restart-time.

Names of Commands Used

```

bgp graceful-restart
bgp graceful-restart graceful-reset
bgp update-delay
neighbor capability graceful-restart
neighbor remote-as
neighbor restart-time
router bgp

```

Validation Commands

```

show ip bgp
show ip bgp neighbors
show ip bgp summary
show ip route
show ip route database

```

Chapter 38: BGP Commands



Command List	38.4
address-family.....	38.4
aggregate-address (BGP)	38.5
auto-summary.....	38.7
bgp aggregate-nexthop-check	38.8
bgp always-compare-med.....	38.9
bgp bestpath as-path ignore	38.10
bgp bestpath compare-confed-aspath	38.10
bgp bestpath compare-routerid	38.11
bgp bestpath med.....	38.12
bgp bestpath med remove-recv-med	38.14
bgp bestpath med remove-send-med	38.14
bgp client-to-client reflection	38.15
bgp cluster-id.....	38.16
bgp confederation identifier	38.17
bgp confederation peers.....	38.18
bgp config-type.....	38.19
bgp dampening.....	38.20
bgp default ipv4-unicast.....	38.21
bgp default local-preference	38.22
bgp deterministic-med	38.23
bgp enforce-first-as	38.24
bgp fast-external-failover	38.25
bgp graceful-restart	38.26
bgp graceful-restart graceful-reset	38.28
bgp log-neighbor-changes	38.29
bgp memory maxallocation	38.30
bgp multiple-instance	38.31
bgp nexthop-trigger-count	38.32
bgp nexthop-trigger delay.....	38.33
bgp nexthop-trigger enable.....	38.34
bgp rfc1771-path-select	38.35
bgp rfc1771-strict.....	38.35
bgp router-id	38.36
bgp scan-time.....	38.37
bgp update-delay.....	38.38
clear bgp *	38.39
clear bgp (ip address)	38.40
clear bgp (ASN).....	38.41
clear bgp external	38.42
clear bgp peer-group	38.43
clear bgp view	38.44
clear ip bgp *	38.45
clear ip bgp (ip address).....	38.46
clear ip bgp dampening	38.47
clear ip bgp flap-statistics	38.48
clear ip bgp (ASN)	38.49

clear ip bgp external	38.51
clear ip bgp peer-group	38.52
clear ip bgp view	38.54
debug bgp	38.55
distance (BGP)	38.56
exit-address-family	38.57
ip as-path access-list	38.58
ip community-list	38.59
ip community-list expanded	38.60
ip community-list standard	38.62
ip extcommunity-list expanded	38.64
ip extcommunity-list standard	38.66
neighbor activate	38.68
neighbor advertisement-interval	38.69
neighbor allowas-in	38.70
neighbor as-origination-interval	38.71
neighbor attribute-unchanged	38.72
neighbor capability dynamic	38.73
neighbor capability graceful-restart	38.74
neighbor capability orf prefix-list	38.75
neighbor capability route-refresh	38.76
neighbor collide-established	38.77
neighbor connection-retry-time	38.78
neighbor default-originate	38.79
neighbor description	38.80
neighbor disallow-infinite-holdtime	38.81
neighbor distribute-list	38.82
neighbor dont-capability-negotiate	38.83
neighbor ebgp-multihop	38.84
neighbor enforce-multihop	38.85
neighbor filter-list	38.86
neighbor interface	38.87
neighbor maximum-prefix	38.88
neighbor next-hop-self	38.89
neighbor override-capability	38.90
neighbor passive	38.91
neighbor password	38.92
neighbor peer-group (adding a neighbor)	38.93
neighbor peer-group (creating a peer-group)	38.94
neighbor port	38.95
neighbor prefix-list	38.96
neighbor remote-as	38.97
neighbor remove-private-AS	38.98
neighbor restart-time	38.99
neighbor route-map	38.100
neighbor route-reflector-client	38.101
neighbor route-server-client	38.102
neighbor send-community	38.103
neighbor shutdown	38.104
neighbor soft-reconfiguration inbound	38.105
neighbor strict-capability-match	38.106
neighbor timers	38.107
neighbor transparent-as	38.108
neighbor transparent-next-hop	38.109
neighbor unsuppress-map	38.110
neighbor update-source	38.111
neighbor version	38.112

neighbor weight.....	38.113
network (BGP)	38.114
network synchronization.....	38.115
redistribute route-map.....	38.116
restart bgp graceful.....	38.117
router bgp.....	38.118
router bgp view.....	38.119
show bgp nexthop-tracking.....	38.120
show bgp nexthop-tree-details	38.120
show bgp memory maxallocation	38.120
show debugging bgp	38.121
show ip bgp	38.122
show ip bgp attribute-info.....	38.123
show ip bgp cidr-only	38.124
show ip bgp community.....	38.125
show ip bgp community-info.....	38.126
show ip bgp community-list	38.126
show ip bgp dampening	38.127
show ip bgp filter-list	38.128
show ip bgp inconsistent-as	38.129
show ip bgp longer-prefixes.....	38.130
show ip bgp neighbors.....	38.131
show ip bgp neighbors connection-retrytime.....	38.132
show ip bgp neighbors hold-time.....	38.133
show ip bgp neighbors keepalive	38.133
show ip bgp neighbors keepalive-interval	38.134
show ip bgp neighbors notification.....	38.134
show ip bgp neighbors open.....	38.135
show ip bgp neighbors rcvd-msgs	38.135
show ip bgp neighbors sent-msgs.....	38.136
show ip bgp neighbors update	38.136
show ip bgp paths.....	38.137
show ip bgp prefix-list	38.137
show ip bgp quote-regexp	38.138
show ip bgp regexp	38.138
show ip bgp route-map.....	38.139
show ip bgp scan.....	38.139
show ip bgp summary	38.140
show ip bgp view	38.141
show ip bgp view neighbors	38.142
show ip bgp view summary.....	38.143
show ip community-list.....	38.144
show ip extcommunity-list.....	38.144
show ip protocols bgp.....	38.145
synchronization.....	38.146
timers (BGP)	38.147
undebg bgp	38.148

Command List

This chapter provides an alphabetical reference of commands used to configure the Border Gateway Protocol (BGP). For more information, see [Chapter 37, BGP Configuration](#).

address-family

This command enters the IPv4 address-family command mode. In this mode you can configure address-family specific parameters.

Use the [exit-address-family](#) command to leave the address family mode and return to Router Configuration mode.

Syntax `address-family ipv4 [multicast|unicast]`

Parameter	Description
<code>ipv4</code>	Configure parameters relating to the BGP exchange of IPv4 prefixes.
<code>multicast</code>	Configure parameters relating to the BGP exchange of routes to multicast sources.
<code>unicast</code>	Configure parameters relating to the BGP exchange of routes to unicast destinations.

Mode Router Configuration

Usage If you specify **address-family IPv4 multicast**, you configure BGP to exchange routing information about how to reach multicast sources instead of unicast destinations. The PIM Reverse Path Forwarding (RPF) process always checks whether a stream is arriving on the interface that faces towards the best route to the source address of the multicast stream.

In general, a router will look into the unicast IPv4 routing table to find the best route to the source. However, the BGP multicast extensions, which are configured in multicast address-family mode, enable the router to carry a separate route table specifically for looking up RPF routes to multicast source addresses. This enables a network to forward multicast data along different paths those used for forwarding unicast data.

Example

```
awplus# configure terminal
awplus(config)# router bgp 100
awplus(config-router)# neighbor 192.168.0.1 interface
port1.0.2
awplus(config-router)# address-family ipv4
awplus(config-router-af)# neighbor 192.168.0.1 activate
awplus(config-router-af)# exit-address-family
awplus(config-router)#
```

Related Commands [exit-address-family](#)

aggregate-address (BGP)

This command adds an aggregate route that can be advertised to BGP neighbors. This command creates an aggregate entry in the BGP routing table if the switch learns, by any means, any routes that are within the range configured by the aggregate address/mask.

The **no** variant of this command removes the aggregate configured by the **aggregate-address** command.

Syntax `aggregate-address <ipaddr/m> {summary-only|as-set}`
`no aggregate-address <ipaddr/m> {summary-only|as-set}`

Parameter	Description
<code><ipaddr/m></code>	Specifies the aggregate IPv4 address and mask.
<code>summary-only</code>	Filters more specific routes from updates. Only the aggregate address/mask will be advertised, and none of the component addresses that fall within the range of the aggregate address/mask.
<code>as-set</code>	Generates AS set path information. The AS-path advertised with the aggregate is an unordered list of all the AS-numbers that appear in any of the AS-paths of the component routes, with each AS-number appearing just once in the list.

Mode Router Configuration

Usage If the `summary-only` parameter is specified, then only the aggregate address/mask will be advertised, and none of the component addresses that fall within the range of the aggregate address/mask. For example, if you configure:

```
awplus#configure terminal
awplus(config)#router bgp 100
awplus(config-router)#aggregate-address 172.0.0.0/8 summary-only
```

then the switch will advertise the prefix `172.0.0.0/8`, but no component routes like `172.10.0.0/16`

The `as-set` parameter controls the AS-path attribute that is advertised with the aggregate route. If the switch has learnt multiple routes that are within the range of the aggregate address/mask, and the AS-paths associated with those routes contain different sets of AS-numbers, then it is not possible to create a single AS-path that accurately represents the AS-paths of all those component routes. In this case, the switch will, by default, advertise a NULL AS-path with the aggregate.

Example

```
awplus# configure terminal
awplus(config)# router bgp 100
awplus(config-router)# aggregate-address 192.0.0.0/8 as-set
summary-only
```

Related Commands [match as-path](#)

auto-summary

Use this command to enable sending summarized routes by a BGP speaker to its peers in the Router Configuration mode or in the Address-Family Configuration mode. BGP uses auto-summary to advertise summarized routes.

Use the **no** variant of this command to disable BGP auto-summary.

Syntax auto-summary

no auto-summary

Default The auto-summary function is disabled by default.

Mode Router Configuration and Address Family IPv4 mode

Usage If certain routes have already been advertised, enabling auto-summary results in non-summarized routes being withdrawn and only summarized routes are advertised. Summarized routes are advertised before non-summarized routes are withdrawn from all connected peers.

If certain routes have already been advertised, disabling auto-summary results in summarized routes being withdrawn and only non-summarized routes are advertised. Non-summarized routes are advertised before summarized routes are withdrawn from all connected peers.

Examples The following example enables auto-summary in Router Configuration mode:

```
awplus# configure
awplus(config)# router bgp 100
awplus(config-router)# auto-summary
```

The following example disables auto-summary in Router Configuration mode:

```
awplus# configure terminal
awplus(config)# router bgp 100
awplus(config-router)# no auto-summary
```

The following example enables auto-summary in Address Family IPv4 mode:

```
awplus# configure terminal
awplus(config)# router bgp 100
awplus(config-router)# address-family ipv4
awplus(config-router-af)# auto-summary
```

The following example disables auto-summary in Address Family IPv4 mode:

```
awplus# configure terminal
awplus(config)# router bgp 100
awplus(config-router)# address-family ipv4
awplus(config-router-af)# no auto-summary
```

bgp aggregate-next-hop-check

This command enables the BGP option to perform aggregation only when next-hop matches the specified IP address. By default this is disabled.

The **no** variant of this command disables this function.

Syntax `bgp aggregate-next-hop-check`
`no bgp aggregate-next-hop-check`

Mode Global Configuration

Example

```
awplus# configure terminal
awplus(config)# bgp aggregate-next-hop-check
```

bgp always-compare-med

This command enables BGP to compare the Multi Exit Discriminator (MED) for paths from neighbors in different autonomous systems.

Multi Exit Discriminator (MED) is used in best path selection by BGP. MED is compared after BGP attributes weight, local preference, AS-path and origin have been compared and are equal.

By default, MED comparison is done only among routes from the same autonomous system (AS). Use the **bgp always-compare-mode** command to allow comparison of MEDs from different ASs.

A path with a lower MED value is preferred. For example, if the bgp table contains the following entries, and the **bgp always-compare-med** command has been issued to enable this feature:

```
Route1: as-path 400, med 300
```

```
Route2: as-path 200, med 200
```

```
Route3: as-path 400, med 250
```

Route1 is compared to Route2. Route2 is best of the two (lower MED). Next, Route2 is compared to Route3 and Route2 is chosen best path again (lower MED). If **always-compare-med** was disabled, MED is not taken into account when Route1 and Route2 are compared, because of different ASs and MED is compared for only Route1 and Route3. In this case, Route3 would be the best path. The selected route is also affected by the **bgp deterministic-med** command. See the [bgp deterministic-med command on page 38.23](#) for details.

If this command is used to compare MEDs for all paths, it should be configured on every BGP router in the AS.

The **no** variant of this command disallows the comparison.

Syntax `bgp always-compare-med`
`no bgp always-compare-med`

Default By default this feature is disabled.

Mode Router Configuration

Example

```
awplus# configure terminal
awplus(config)# router bgp 100
awplus(config-router)# bgp always-compare-med
```

Related Commands [bgp bestpath med](#)
[bgp bestpath as-path ignore](#)
[bgp bestpath compare-routerid](#)
[bgp deterministic-med](#)

bgp bestpath as-path ignore

This command prevents the router from considering as-path as a factor in the algorithm for choosing a route.

The **no** variant of this command allows the router to consider as-path in choosing a route.

Syntax `bgp bestpath as-path ignore`
`no bgp bestpath as-path ignore`

Mode Router Configuration

Example

```
awplus# configure terminal
awplus(config)# router bgp 100
awplus(config-router)# bgp bestpath as-path ignore
```

Related Commands [bgp always-compare-med](#)
[bgp bestpath med](#)
[bgp bestpath compare-routerid](#)

bgp bestpath compare-confed-aspath

This command specifies that the AS confederation path length must be used, when available, in the BGP best path decision process. It is effective only when **bgp bestpath as-path ignore** command has not been specified.

By default, if BGP receives routes with identical eBGP paths from eBGP peers, BGP does not continue to consider any AS confederation path length attributes that may be associated with the routes.

The **no** variant of this command returns the switch to the default state, where the switch ignores AS confederation path length in the BGP best path selection process.

Syntax `bgp bestpath compare-confed-aspath`
`no bgp bestpath compare-confed-aspath`

Mode Router Configuration

Example

```
awplus# configure terminal
awplus(config)# router bgp 100
awplus(config-router)# bgp bestpath compare-confed-aspath
```

Related Commands [bgp bestpath as-path ignore](#)

bgp bestpath compare-routerid

By default, when comparing similar routes from peers, BGP does not consider the router ID of neighbors advertising the routes - BGP simply selects the first received route. Use the **bgp bestpath compare-routerid** command to include router ID in the selection process; similar routes are compared and the route with the lowest router ID is selected.

The **no** variant of this command disables this feature, and returns the switch to the default state, where the switch ignores the router ID in the BGP best path selection process.

Syntax `bgp bestpath compare-routerid`
`no bgp bestpath compare-routerid`

Mode Router Configuration

Example

```
awplus# configure terminal
awplus(config)# router bgp 100
awplus(config-router)# bgp bestpath compare-routerid
```

Related Commands `show ip bgp`
`show ip bgp neighbors`

bgp bestpath med

This command controls how the Multi Exit Discriminator (MED) attribute comparison is performed.

Use the **no** variant of this command to prevent BGP from considering the MED attribute when comparing paths.

Syntax `bgp bestpath med {[confed] [missing-as-worst]}`

Parameter	Description
<code>confed</code>	Compares MED among confederation paths
<code>missing-as-worst</code>	Treats missing MED as the least preferred one

Mode Router Configuration

Usage The **confed** parameter enables MED comparison among paths learned from confederation peers. The MED attributes are compared only if there is no external AS (Autonomous System), where an external AS is one that is not within the confederation. If there is an external AS in the path, then the MED comparison is not made.

For example, in the following paths the MED value is not compared with `Path3` since it is not in the confederation. MED is compared for `Path1` and `Path2` only.

```
Path1 = 32000 32004, med=4
```

```
Path2 = 32001 32004, med=2
```

```
Path3 = 32003 1, med=1
```

The effect of the **missing-as-worst** parameter is to treat a missing MED attribute in a path as having a value of infinity, making the path without a MED value the least desirable path. If the **missing-as-worst** parameter is not configured, the missing MED attribute is assigned the value of 0, making the path with the missing MED attribute the best path.

Examples

```
awplus# configure terminal
awplus(config)# router bgp 100
awplus(config-router)# bgp bestpath med missing-as-worst
```

```
awplus# configure terminal
awplus(config)# router bgp 100
awplus(config-router)# bgp bestpath med confed
```

```
awplus# configure terminal
awplus(config)# router bgp 100
awplus(config-router)# bgp bestpath med confed missing-as-worst
```

Related Commands `bgp always-compare-med`
 `bgp bestpath as-path ignore`
 `bgp deterministic-med`

bgp bestpath med remove-recv-med

This command removes the Multi Exit Discriminator (MED) attribute from the update messages received by the BGP speaker from its peers. However, the local BGP speaker will send MED attributes in the update messages to its peers, unless specified not to by the **bgp bestpath med remove-send-med** command.

Use the **no** variant of this command to disable this feature.

Syntax `bgp bestpath med remove-recv-med`
`no bgp bestpath med remove-recv-med`

Mode Router Configuration

Example To enable the **remove-recv-med** feature on the BGP speaker belonging to the Autonomous System (AS) 100, enter the command:

```
awplus# configure terminal
awplus(config)# router bgp 100
awplus(config-router)# bgp bestpath med remove-recv-med
```

Related Commands [bgp bestpath med remove-send-med](#)

bgp bestpath med remove-send-med

This command removes the Multi Exit Discriminator (MED) attribute from the update messages sent by the BGP speaker to its peers. However, the local BGP speaker will consider the MED attribute received from other peers during the decision and route selection process, unless specified not to by the **bgp bestpath med remove-recv-med** command.

Use the **no** variant of this command to disable this feature.

Syntax `bgp bestpath med remove-send-med`
`no bgp bestpath med remove-send-med`

Mode Router Configuration

Example To enable the **remove-send-med** feature on the BGP speaker belonging to the Autonomous System (AS) 100, enter the command:

```
awplus# configure terminal
awplus(config)# router bgp 100
awplus(config-router)# bgp bestpath med remove-send-med
```

Related Commands [bgp bestpath med remove-recv-med](#)

bgp client-to-client reflection

This command restores route reflection from a BGP route reflector to clients.

The **bgp client-to-client reflection** command is used to configure routers as route reflectors. Route reflectors are used when all Interior Border Gateway Protocol (IBGP) speakers are not fully meshed. If the clients are fully meshed the route reflector is not required, use the **no** variant of this command to disable the client-to-client route reflection.

When a router is configured as a route reflector, client-to-client reflection is enabled by default.

The **no** variant of this command turns off client-to-client reflection.

Syntax `bgp client-to-client reflection`
`no bgp client-to-client reflection`

Mode Router Configuration

Example

```
awplus# configure terminal
awplus(config)# router bgp 100
awplus(config-router)# no bgp client-to-client reflection
```

Related Commands `bgp cluster-id`
`neighbor route-reflector-client`
`show ip bgp`

bgp cluster-id

This command configures the cluster-id if the BGP cluster has more than one route reflector. A cluster includes one or more route reflectors and their clients. Usually, each cluster is identified by the router-id of its single route reflector. However, to increase redundancy, a cluster may sometimes have more than one route reflector. All route reflectors in such a cluster are then identified by a cluster-id.

The **bgp cluster-id** command is used to configure the 4 byte cluster ID for clusters with more than one route reflector.

The **no** variant of this command removes the cluster ID.

Syntax `bgp cluster-id {<ip-address>|<cluster-id>}`
`no bgp cluster-id [<ip-address>]`

Parameter	Description
<code><cluster-id></code>	<code><1-4294967295></code> Route Reflector cluster-id as a 32 bit quantity
<code><ip-address></code>	<code>A.B.C.D</code> Route Reflector Cluster-id in IP address format

Mode Router Configuration

Usage The following configuration creates `cluster-id 5` including two route-reflector-clients.

```
awplus(config)# router bgp 200
awplus(config-router)# neighbor 2.2.2.2 remote-as 200
awplus(config-router)# neighbor 3.3.3.3 remote-as 200
awplus(config-router)# neighbor 3.3.3.3 route-reflector-client
awplus(config-router)# neighbor 5.5.5.5 remote-as 200
awplus(config-router)# neighbor 5.5.5.5 route-reflector-client
awplus(config-router)# neighbor 6.6.6.6 remote-as 200
awplus(config-router)# bgp cluster-id 5
```

Examples To add a **bgp cluster-id** apply the example commands as shown below:

```
awplus# configure terminal
awplus(config)# router bgp 100
awplus(config-router)# bgp cluster-id 10.10.1.1
```

To remove a **bgp cluster-id** apply the example commands as shown below:

```
awplus# configure terminal
awplus(config)# router bgp 100
awplus(config-router)# no bgp cluster-id 10.10.1.1
```

Related Commands [bgp client-to-client reflection](#)
[neighbor route-reflector-client](#)
[show ip bgp](#)

bgp confederation identifier

This command specifies a BGP confederation identifier.

The **no** variant of this command removes all BGP confederation identifiers.

Syntax `bgp confederation identifier <1-65535>`
`no bgp confederation identifier`

Parameter	Description
<code><1-65535></code>	Set routing domain confederation AS number.

Mode Router Configuration

Examples

```
awplus# configure terminal
awplus(config)# router bgp 100
awplus(config-router)# bgp confederation identifier 1

awplus# configure terminal
awplus(config)# router bgp 100
awplus(config-router)# no bgp confederation identifier
```

Related Commands [bgp confederation peers](#)

bgp confederation peers

This command configures the Autonomous Systems (AS) that belong to the same confederation as the current switch.

A confederation allows an AS to be divided into several sub-ASs. The overall AS is given a confederation identifier. External routers view only the whole confederation as one AS, whose AS number is the confederation identifier. Each sub-AS is fully meshed within itself and is visible internally to the confederation.

Use the **bgp confederation peer** command to define the list of AS numbers of the sub-ASs in the confederation containing the current switch.

The **no** variant of this command removes an autonomous system from the confederation.

Syntax `bgp confederation peers <1-65535>`
`no bgp confederation peers <1-65535>`

Parameter	Description
<1-65535>	AS numbers of eBGP peers that are under same confederation but in a different sub-AS.

Mode Router Configuration

Usage In the following configuration of **Router1** the neighbor 172.210.30.2 and 172.210.20.1 have iBGP connection within AS 100. The neighbor 173.213.30.1 has an BGP connection, but it is within AS 200, which is part of the same confederation. The neighbor 6.6.6.6 has an eBGP connection to external AS 500.

In the configuration of **Router2**, neighbor 5.5.5.4 has an eBGP connection to confederation 300. **Router2** does not know about the ASs 100 and 200, it only knows about confederation 300.

Router1

```
awplus(config)# router bgp 100
awplus(config-router)# bgp confederation identifier 300
awplus(config-router)# bgp confederation peers 200
awplus(config-router)# neighbor 172.210.30.2 remote-as 100
awplus(config-router)# neighbor 172.210.20.1 remote-as 100
awplus(config-router)# neighbor 173.213.30.1 remote-as 200
awplus(config-router)# neighbor 6.6.6.6 remote-as 300
```

Router2

```
awplus(config)# router bgp 500
awplus(config-router)# neighbor 5.5.5.4 remote-as 300
```

Example

```
awplus# configure terminal
awplus(config)# router bgp 100
awplus(config-router)# bgp confederation peers 1234
```

Related Commands [bgp confederation identifier](#)

bgp config-type

This command sets the BGP configuration type.

Syntax `bgp config-type {standard|extended}`

Parameter	Description
standard	Specifies the industry standard style configuration. After setting the configuration to standard , make sure to use the neighbor send-community command to send out BGP community attributes. The no synchronization command is always shown in the configuration.
extended	Specifies the extended style configuration. The extended configuration type requires no specific configuration for sending out BGP standard community and extended community attributes. The no synchronization command is enabled by default in Global Configuration mode and not shown in configuration output.

Default By default, the BGP configuration type is **extended**.

Mode Global Configuration

Example

```
awplus# configure terminal
awplus(config)# bgp config-type standard
```

Related Commands [neighbor send-community](#)

bgp dampening

This command enables BGP dampening and sets BGP dampening parameters.

Route dampening minimizes the instability caused by route flapping. A penalty is added for every flap in a flapping route. As soon as the total penalty reaches the **suppress** limit the advertisement of the route is suppressed. This penalty is decayed according to the configured **half time** value. Once the penalty is lower than the **reuse** limit, the route advertisement is un-suppressed.

The dampening information is purged from the router once the penalty becomes less than half of the **reuse** limit.

The **no** variant of this command disables BGP dampening or unsets the BGP dampening parameters.

Syntax

```

bgp dampening
no bgp dampening

bgp dampening <reachtime>
no bgp dampening <reachtime>

bgp dampening <reachtime> <reuse> <suppress> <maxsuppress>
<unreachtime>
no bgp dampening <reachtime> <reuse> <suppress> <maxsuppress>
<unreachtime>

bgp dampening route-map <routemap-name>
no bgp dampening route-map <routemap-name>

```

Parameter	Description
<reachtime>	<1-45> Specifies the reachability half-life time in minutes. The time for the penalty to decrease to one-half of its current value. The default is 15 minutes.
<reuse>	<1-20000> Specifies the reuse limit value. When the penalty for a suppressed route decays below the reuse value, the routes become un-suppressed. The default reuse limit is 750
<suppress>	<1-20000> Specifies the suppress limit value. When the penalty for a route exceeds the suppress value, the route is suppressed. The default suppress limit is 2000.
<maxsuppress>	<1-255> Specifies the max-suppress-time. Maximum time that a dampened route is suppressed. The default max-suppress value is 4 times the half-life time (60 minutes).
<unreachtime>	<1-45> Specifies the un-reachability half-life time for penalty, in minutes.
route-map	Route-map to specify criteria for dampening.
<routemap-name>	Specify the name of the route-map.

Mode Router Configuration

Example

```
awplus# configure terminal
awplus(config)# router bgp 11
awplus(config-router)# bgp dampening 20 800 2500 80 25
```

bgp default ipv4-unicast

This command configures BGP defaults and activates IPv4-unicast for a peer by default. This affects the BGP global configuration.

The **no** variant of this command disables this function. The BGP routing process will no longer exchange IPv4 addressing information with BGP neighbor routers.

Syntax `bgp default ipv4-unicast`
`no bgp default ipv4-unicast`

Default This is enabled by default.

Mode Router Configuration

Example

```
awplus# configure terminal
awplus(config)# router bgp 100
awplus(config-router)# bgp default ipv4-unicast
```

bgp default local-preference

This command changes the default local preference value.

The local preference indicates the preferred path when there are multiple paths to the same destination. The path with the higher preference is preferred.

Use this command to define the default local preference value that the switch will advertise for the routes it sends. The preference is sent to all routers and access servers in the local autonomous system.

The **no** variant of this command reverts to the default local preference value of 100.

Syntax `bgp default local-preference <pref-value>`
`no bgp default local-preference [<pref-value>]`

Parameter	Description
<code><pref-value></code>	<code><0-4294967295></code> Configure default local preference value. The default local preference value is 100.

Default By default the local-preference value is 100.

Mode Router Configuration

Examples

```
awplus# configure terminal
awplus(config)# router bgp 100
awplus(config-router)# bgp default local-preference 2345555

awplus# configure terminal
awplus(config)# router bgp 100
awplus(config-router)# no bgp default local-preference
```

bgp deterministic-med

Use this command to allow or disallow the switch to compare the Multi Exit Discriminator (MED) variable when choosing among routes advertised by different peers in the same autonomous system (AS).

Use the **bgp deterministic-med** command to enable this feature to allow the comparison of MED variables when choosing among routes advertised by different peers in the same AS.

Use the **no** variant of this command to disable this feature to disallow the comparison of the MED variable when choosing among routes advertised by different peers in the same AS.

Syntax `bgp deterministic-med`
`no bgp deterministic-med`

Default Disabled by default

Mode Router Configuration

Usage When the **bgp deterministic-med** command is enabled, routes from the same AS are grouped together and ordered according to their MED values, and the best routes of each group are compared.

The main benefit of this is that the choice of best route then does not depend on the order in which the routes happened to be received, which is rather random and arbitrary.

To see how this works, consider the following set of `bgp` table entries, all for the same route:

```
1: ASPATH 234, MED 120, internal, IGP metric to NEXT_HOP 40
2: ASPATH 389, MED 190, internal, IGP metric to NEXT_HOP 35
3: ASPATH 234, MED 245, external
```

If **bgp deterministic-med** is not enabled, then entry 3 : will be chosen, because it is an external route.

But if BGP deterministic-MED is enabled, the entries will be grouped as follows:

```
Group 1: 1: ASPATH 234, MED 120, internal, IGP metric to NEXT_HOP 40
          3: ASPATH 234, MED 245, external
Group 2: 2: ASPATH 389, MED 190, internal, IGP metric to NEXT_HOP 35
```

Note Routes from the same AS are grouped together and ordered by MED.



Entry 1 : is chosen as the best route from `Group 1`, since this route has the lowest MED value. Entry 2 has to be the best route in `Group 2`, since this is the only route in that group. These two group winners are compared against each other, and Entry 2 : is chosen as the best route because Entry 2 : has the lower metric to next-hop.

All routers in an AS should have the same setting for BGP deterministic-MED. All routers in an AS should have BGP deterministic-MED enabled with **bgp deterministic-med**, or all routers in an AS should have BGP deterministic-MED disabled with **no bgp-deterministic-med**.

In the example above, the MED values were not considered when comparing the winners of the two groups (the best routes from the different ASs). To use MED in the comparison of routes from different ASs, use the [bgp always-compare-med command on page 38.9](#).

Examples

```
awplus# configure terminal
awplus(config)# router bgp 100
awplus(config-router)# bgp deterministic-med

awplus# configure terminal
awplus(config)# router bgp 100
awplus(config-router)# no bgp deterministic-med
```

Related Commands [show ip bgp](#)
[show ip bgp neighbors](#)

bgp enforce-first-as

Use this command to enforce the denying of eBGP updates in which the neighbor's AS number is not the first AS in the AS-path attribute.

Use the **no** variant of this command to disable this feature.

Syntax `bgp enforce-first-as`
`no bgp enforce-first-as`

Mode Router Configuration

Usage This command specifies that any updates received from an external neighbor that do not have the neighbor's configured Autonomous System (AS) at the beginning of the AS_PATH in the received update must be denied. Enabling this feature adds to the security of the BGP network by not allowing traffic from unauthorized systems.

Example

```
awplus# configure terminal
awplus(config)# router bgp 100
awplus(config-router)# bgp enforce-first-as
```

bgp fast-external-failover

Use this command to reset a BGP session immediately if the interface used for BGP connection goes down.

Use the **no** variant of this command to disable this feature.

Syntax `bgp fast-external-failover`
`no bgp fast-external-failover`

Default Enabled

Mode Router Configuration

Example

```
awplus# configure terminal
awplus(config)# router bgp 100
awplus(config-router)# bgp fast-external-failover
```

bgp graceful-restart

Use this command to enable BGP graceful-restart capabilities for restart and stalepath times.

Use the **no** variant of this command to restore restart timers to their default settings.

Syntax `bgp graceful-restart`
`[restart-time <delay-value>|stalepath-time <delay-value>]`
`no bgp graceful-restart [restart-time|stalepath-time]`

Parameter	Description
<code>restart-time</code>	The maximum time needed for neighbors to restart, in seconds. The default restart-time is 120 seconds.
<code>stalepath-time</code>	The maximum time to retain stale paths from restarting neighbors, in seconds. The default stalepath-time is 120 seconds.
<code><delay-value></code>	<code><1-3600></code> Maximum time in seconds. Default is 120 seconds.

Default The default BGP graceful restart time is 120 seconds without restart-time or stalepath-time parameters specified. The default restart-time and stalepath-times are also 120 seconds.

Mode Router Configuration

Usage This command is used to set the maximum time that a graceful-restart neighbor waits to come back up after a restart. This value is applied to all neighbors unless you explicitly override it by configuring the corresponding value on the neighbor.

The **restart-time** parameter is used for setting the maximum time that a graceful-restart neighbor waits to come back up after a restart. This **restart-time** value is applied to neighbors unless you explicitly override it by configuring the corresponding value on the neighbor.

The `stalepath-time` parameter is used to set the maximum time to preserve stale paths from a gracefully restarted neighbor. All stalepaths, unless reinstated by the neighbor after a re-establishment, will be deleted when time, as specified by the `stalepath-time` parameter, expires.

Examples

```
awplus# configure terminal
awplus(config)# router bgp 10
awplus(config-router)# bgp graceful-restart 150
```

```
awplus# configure terminal
awplus(config)# router bgp 10
awplus(config-router)# no bgp graceful-restart
```

```
awplus# configure terminal
awplus(config)# router bgp 10
awplus(config-router)# bgp graceful-restart restart-time 150
```

```
awplus# configure terminal
awplus(config)# router bgp 10
awplus(config-router)# no bgp graceful-restart restart-time 150
```

Related Commands [bgp graceful-restart](#) [graceful-reset](#)

bgp graceful-restart graceful-reset

This command enables BGP graceful-restart when a configuration change forces a peer restart. Use the **no** variant of this command to restore the device to its default state.

Syntax `bgp graceful-restart graceful-reset`
`no bgp graceful-restart graceful-reset`

Default By default this feature is disabled.

Mode Router Configuration

Usage The [bgp graceful-restart command on page 38.26](#) must be enabled before the this command is enabled. All events that cause BGP peer reset, including all session reset commands, can trigger graceful-restart.

Example To enable the graceful-restart graceful-reset feature on the BGP peer belonging to the Autonomous System (AS) 100, enter the command:

```
awplus# configure terminal
awplus(config)# router bgp 10
awplus(config-router)# bgp graceful-restart restart-time 150
```

Related Commands [bgp graceful-restart](#)

bgp log-neighbor-changes

Use this command to enable logging of status change messages without turning on **debug bgp** commands.

Use the **no** variant of this command to disable this feature.

Syntax `bgp log-neighbor-changes`
`no bgp log-neighbor-changes`

Default Disabled

Mode Router Configuration

Usage AlliedWare Plus™ provides other kinds of logging services for neighbor status, for example, **debug bgp fsm**, **debug bgp events**, etc. However, these commands create a significant hit in the logging performance. If you need to log neighbor status changes only, we recommend turning off all the debug commands, and then use this command.

To see bgp neighbor changes in the log you need to set the log level to informational using the **log buffered (filter)** command in [Chapter 10, Logging Commands](#).

A sample output of this log is:

```
%Protocol-Severity-Events: Message-text
```

A sample output of the log for an `interface down` event is:

```
%BGP-5-ADJCHANGE: neighbor 10.10.0.24 Down Interface flap
```

The **bgp log-neighbor-changes** command, logs the following events:

- BGP Notification Received
- Erroneous BGP Update Received
- User reset request
- Peer time-out
- Peer Closing down the session
- Interface flap
- Router ID changed
- Neighbor deleted
- Member added to peer group
- Administrative shutdown
- Remote AS changed
- RR client configuration modification
- Soft reconfiguration modification

Example To enable the logging of bgp status changes without using the `debug bgp` command:

```
awplus# configure terminal
awplus(config)# router bgp 100
awplus(config-router)# bgp log-neighbor-changes
```

bgp memory maxallocation

This command allocates a maximum percentage of the RAM (Random Access Memory) available on the switch for BGP processes.

When this percentage is exceeded, BGP peering terminates and an **out of resources** error displays. The default setting for **bgp memory maxallocation** is 100% memory allocation.

Use the **no** variant of this command to reset memory allocation to the default value.

Syntax `bgp memory maxallocation <1-100>`
`no bgp memory maxallocation`

Parameter	Description
<1-100>	Percentage of switch memory allocated to BGP processes. Note this is RAM (Random Access Memory), not switch flash memory.

Default BGP processes are allocated the maximum percentage of 100% of the switch's available RAM memory by default. Note only non-default BGP memory allocation values are shown in the running or startup configuration files:

```
awplus#show running-config
!
bgp memory maxallocation 50
!
```

Mode Global Configuration

Examples To limit the maximum amount of memory used by BGP processes to 65% of the total RAM memory available on the switch, use the commands:

```
awplus# configure terminal
awplus(config)# bgp memory maxallocation 65
```

To return to the default 100% maximum RAM memory allocation available on the switch for BGP processes, use the commands:

```
awplus# configure terminal
awplus(config)# no bgp memory maxallocation
```

bgp multiple-instance

Use this command to enable or disable the BGP multiple-instance support.

Use the **no** variant of this command to disable this function.

Syntax `bgp multiple-instance [allow-same-peer]`

`no bgp multiple-instance`

Parameter	Description
<code>allow-same-peer</code>	Activate the same peer in multiple BGP views.

Default No multiple-instance support

Mode Global Configuration

Example To enable multiple-instance support, enter the command:

```
awplus# configure terminal
awplus(config)# bgp multiple-instance
```

bgp nexthop-trigger-count

Use this command to configure the display of BGP nexthop-tracking status.

Use the **no** variant of this command to disable this function.

Syntax `bgp nexthop-trigger-count <1-127>`
`no bgp nexthop-trigger-count <1-127>`

Parameter	Description
<1-127>	BGP nexthop-tracking status

Mode Router Configuration

Example To enable nexthop-tracking status on the BGP peer belonging to the Autonomous System (AS) 100, enter the command:

```
awplus# configure terminal
awplus(config)# router bgp 100
awplus(config-router)# bgp nexthop-trigger-count 10
```

Related Commands [bgp nexthop-trigger delay](#)
[bgp nexthop-trigger enable](#)
[show bgp nexthop-tracking](#)

bgp nexthop-trigger delay

Use this command to set the delay interval for nexthop address tracking.

Use the **no** variant of this command to reset the timer value to the default value.

Syntax `bgp nexthop-trigger delay <1-100>`

`no bgp nexthop-trigger delay`

Parameter	Description
<code><1-100></code>	Nexthop trigger delay interval in seconds.

Default The default nexthop delay interval is 5 seconds.

Mode Global Configuration

Usage This command configures the delay interval between routing table walks for nexthop delay tracking. The delay interval determines how long BGP waits after it receives the trigger from NSM about one or more nexthop changes before it walks the full BGP table to determine which prefixes are affected by the nexthop changes.

Example To set the nexthop delay interval to 6 seconds, enter the command:

```
awplus# configure terminal
awplus(config)# bgp nexthop-trigger delay 6
```

Related Commands [bgp nexthop-trigger-count](#)
[bgp nexthop-trigger enable](#)

bgp nexthop-trigger enable

Use this command to enable nexthop address tracking. If nexthop address tracking is enabled and a nexthop trigger delay interval has not been explicitly set with the [bgp nexthop-trigger delay command on page 38.33](#), the default delay interval of 5 seconds is used.

Use the **no** variant of this command to disable this feature.

Syntax `bgp nexthop-trigger enable`
`no bgp nexthop-trigger enable`

Default By default this feature is disabled.

Mode Global Configuration

Usage Nexthop address tracking is an event driven notification system that monitors the status of routes installed in the Routing Information Base (RIB) and reports nexthop changes that affect internal BGP (iBGP) or external BGP (eBGP) prefixes directly to the BGP process. This improves the overall BGP convergence time, by allowing BGP to respond rapidly to nexthop changes for routes installed in the RIB.

If nexthop tracking is enabled after certain routes are learnt, the registration of all the nexthops of selected BGP routes are done immediately after the nexthop tracking feature is enabled.

If nexthop tracking is disabled, and if there are still some selected BGP routes, BGP deregisters the nexthops of all of the selected BGP routes from NSM.

If nexthop tracking is disabled when nexthop tracking is in the process of execution, an error appears, and nexthop tracking is not disabled. However, if the nexthop tracking timer is running at the time of negation, the nexthop tracking timer is stopped, and nexthop tracking is disabled.

Example To enable nexthop address tracking, enter the command:

```
awplus# configure terminal
awplus(config)# bgp nexthop-trigger enable
```

Related Commands [bgp nexthop-trigger-count](#)
[bgp nexthop-trigger delay](#)
[show bgp nexthop-tracking](#)

bgp rfc1771-path-select

Use this command to set the RFC1771 compatible path selection mechanism.

Use the **no** variant of this command to revert this setting.

Syntax `bgp rfc1771-path-select`
`no bgp rfc1771-path-select`

Default Industry standard compatible path selection mechanism.

Mode Global Configuration

Example

```
awplus# configure terminal
awplus(config)# bgp rfc1771-path-select
```

bgp rfc1771-strict

Use this command to set the Strict RFC1771 setting.

Use the **no** variant of this command to revert this setting.

Syntax `bgp rfc1771-strict`
`no bgp rfc1771-strict`

Default Disabled

Mode Global Configuration

Example

```
awplus# configure terminal
awplus(config)# bgp rfc1771-strict
```

bgp router-id

Use this command to configure the router identifier.

Use the **no** variant of this command to disable this function.

Syntax `bgp router-id <routerid>`
`no bgp router-id [<routerid>]`

Parameter	Description
<code><routerid></code>	A.B.C.D Specifies the IP address without mask for a manually configured router ID.

Default In case the loopback interface is configured the router-id is set to the IP address of a loopback interface. If not, the highest IP address is the router-id.

Mode Router Configuration

Usage Use **bgp router-id** command to manually configure a fixed router ID as a BGP router identifier.

Examples To configure a router ID with an IP address for a BGP router identifier, enter the commands listed below:

```
awplus# configure terminal
awplus(config)# router bgp 100
awplus(config-router)# bgp router-id 1.1.2.3
```

To disable the router ID for a BGP router identifier enter the commands listed below:

```
awplus# configure terminal
awplus(config)# router bgp 100
awplus(config-router)# no bgp router-id
```

bgp scan-time

Use this command to set the interval for BGP route next-hop scanning.

Use the **no** variant of this command to disable this function.

Syntax `bgp scan-time <time>`
`no bgp scan-time [<time>]`

Parameter	Description
<code><time></code>	<0-60> Scanning interval in seconds.

Default The default scanning interval is 60 seconds.

Mode Router Configuration

Usage Use this command to configure scanning intervals of BGP routers. This interval is the period after which router checks the validity of the routes in its database.

To disable BGP scanning, set the scan time interval to 0 seconds.

Example

```
awplus# configure terminal
awplus(config)# router bgp 100
awplus(config-router)# bgp scan-time 10
```

bgp update-delay

Use this command to specify the update-delay value for a graceful-restart capable router.

Use the **no** variant of this command to revert to the default update-delay value.

Syntax `bgp update-delay <1-3600>`
`no bgp update-delay [<1-3600>]`

Parameter	Description
<1-3600>	Delay value in seconds.

Default The default update-delay value is 120 seconds.

Mode Router Configuration

Usage The update-delay value is the maximum time a graceful-restart capable router which is restarting will defer route-selection and advertisements to all its graceful-restart capable neighbors. This maximum time starts from the instance the first neighbor attains established state after restart. The restarting router prematurely terminates this timer when end-of-rib markers are received from all its graceful-restart capable neighbors.

Example

```
awplus# configure terminal
awplus(config)# router bgp 10
awplus(config-router)# bgp update-delay 345
```

clear bgp *

Use this command to reset the BGP connection for all peers.

Syntax

```
clear bgp *
clear bgp * in [prefix-filter]
clear bgp * out
clear bgp * soft [in|out]
```

Parameter	Description
*	Clears all BGP peers
in	Indicates that incoming advertised routes will be cleared.
prefix-filter	Specifies that a prefix-list will be sent, by the ORF mechanism, to those neighbors with which the ORF capability has been negotiated. The neighbors will be triggered to resend updates, which match the prefix-list filter, to the local router. The local router will then perform a soft reconfiguration.
out	Indicates that outgoing advertised routes will be cleared.
soft in	Soft inbound reset causes the neighbors to resend all their updates to the local switch, without resetting the connection or clearing the entries in the local switch. So, the local switch stores new updates, and uses them to systematically replace existing table entries. This process can use a considerable amount of memory.
soft out	Soft outbound reset causes the switch to simply resend all its updates to the specified neighbor(s), without resetting the connection, or clearing table entries.

Mode Privileged Exec

Examples

```
awplus# clear bgp * soft in
awplus# clear bgp * in prefix-filter
```

clear bgp (ip address)

Use this command to reset the BGP connection for specified peers.

Syntax

```
clear bgp <ip-address>
clear bgp <ip-address> in [prefix-filter]
clear bgp <ip-address> out
clear bgp <ip-address> soft [in|out]
```

Parameter	Description
<ip-address>	Specifies the IPv4 address of the neighbor whose connection is to be reset, entered in the form A.B.C.D.
in	Indicates that incoming advertised routes will be cleared.
prefix-filter	Specifies that a prefix-list will be sent, by the ORF mechanism, to those neighbors with which the ORF capability has been negotiated. The neighbors will be triggered to resend updates, which match the prefix-list filter, to the local router. The local router will then perform a soft reconfiguration.
out	Indicates that outgoing advertised routes will be cleared.
soft in	Soft inbound reset causes the neighbors to resend all their updates to the local switch, without resetting the connection or clearing the entries in the local switch. So, the local switch stores new updates, and uses them to systematically replace existing table entries. This process can use a considerable amount of memory.
soft out	Soft outbound reset causes the switch to simply resend all its updates to the specified neighbor(s), without resetting the connection, or clearing table entries.

Mode Privileged Exec

Examples

```
awplus# clear bgp 3.3.3.3 soft in prefix-filter
awplus# clear bgp 2.2.2.2 out
```

clear bgp (ASN)

Use this command to reset the BGP connection for peers in the specified Autonomous System Number (ASN).

Syntax

```
clear bgp <asn>
clear bgp <asn> in [prefix-filter]
clear bgp <asn> out
clear bgp <asn> soft [in|out]
```

Parameter	Description
<asn>	<1-65535> The AS Number for which all routes will be cleared
in	Indicates that incoming advertised routes will be cleared.
prefix-filter	Specifies that a prefix-list will be sent, by the ORF mechanism, to those neighbors with which the ORF capability has been negotiated. The neighbors will be triggered to resend updates, which match the prefix-list filter, to the local router. The local router will then perform a soft reconfiguration.
out	Indicates that outgoing advertised routes will be cleared.
soft in	Soft inbound reset causes the neighbors to resend all their updates to the local switch, without resetting the connection or clearing the entries in the local switch. So, the local switch stores new updates, and uses them to systematically replace existing table entries. This process can use a considerable amount of memory.
soft out	Soft outbound reset causes the switch to simply resend all its updates to the specified neighbor(s), without resetting the connection, or clearing table entries.

Mode Privileged Exec

Examples

```
awplus# clear bgp 300 soft in prefix-filter
awplus# clear bgp 500 soft out
awplus# clear bgp 300 soft in
awplus# clear bgp 1 in prefix-filter
```

clear bgp external

Use this command to reset the BGP connection for all external peers.

Syntax

```
clear bgp external
clear bgp external in [prefix-filter]
clear bgp external out
clear bgp external soft [in|out]
```

Parameter	Description
external	clears all external peers
in	Indicates that incoming advertised routes will be cleared.
prefix-filter	Specifies that a prefix-list will be sent, by the ORF mechanism, to those neighbors with which the ORF capability has been negotiated. The neighbors will be triggered to resend updates, which match the prefix-list filter, to the local router. The local router will then perform a soft reconfiguration.
out	Indicates that outgoing advertised routes will be cleared.
soft in	Soft inbound reset causes the neighbors to resend all their updates to the local switch, without resetting the connection or clearing the entries in the local switch. So, the local switch stores new updates, and uses them to systematically replace existing table entries. This process can use a considerable amount of memory.
soft out	Soft outbound reset causes the switch to simply resend all its updates to the specified neighbor(s), without resetting the connection, or clearing table entries.

Mode Privileged Exec

Examples

```
awplus# clear bgp external soft in
awplus# clear bgp external in prefix-filter
```

clear bgp peer-group

Use this command to reset the BGP connection for all members of a peer group.

Syntax

```
clear bgp peer-group <peer-group>
clear bgp peer-group <peer-group> in [prefix-filter]
clear bgp peer-group <peer-group> out
clear bgp peer-group <peer-group> soft [in|out]
```

Parameter	Description
peer-group	clears all members of a peer group
<peer-group>	Name of the BGP peer group
in	Indicates that incoming advertised routes will be cleared.
prefix-filter	Specifies that a prefix-list will be sent, by the ORF mechanism, to those neighbors with which the ORF capability has been negotiated. The neighbors will be triggered to resend updates, which match the prefix-list filter, to the local router. The local router will then perform a soft reconfiguration.
out	Indicates that outgoing advertised routes will be cleared.
soft in	Soft inbound reset causes the neighbors to resend all their updates to the local switch, without resetting the connection or clearing the entries in the local switch. So, the local switch stores new updates, and uses them to systematically replace existing table entries. This process can use a considerable amount of memory.
soft out	Soft outbound reset causes the switch to simply resend all its updates to the specified neighbor(s), without resetting the connection, or clearing table entries.

Mode Privileged Exec

Examples

```
awplus# clear bgp peer-group P1 soft in
awplus# clear bgp peer-group P2 in
```

clear bgp view

Use this command to reset all BGP connections.

Syntax `clear bgp view <bgp-view> *`
`clear bgp view <bgp-view> * soft [in|out]`

Parameter	Description
*	Clears all bgp peers
<bgp-view>	Name of the BGP view
soft in	Soft inbound reset causes the neighbors to resend all their updates to the local switch, without resetting the connection or clearing the entries in the local switch. So, the local switch stores new updates, and uses them to systematically replace existing table entries. This process can use a considerable amount of memory.
soft out	Soft outbound reset causes the switch to simply resend all its updates to the specified neighbor(s), without resetting the connection, or clearing table entries.

Mode Privileged Exec

Example

```
awplus# clear bgp view instance1 * soft in
```

clear ip bgp *

Use this command to reset all BGP connections—either by fully resetting sessions, or by performing soft resets.

Syntax

```
clear ip bgp *
clear ip bgp * in [prefix-filter]
clear ip bgp * out
clear ip bgp * soft [in|out]
```

Parameter	Description
*	Clears all bgp peers
in	Indicates that incoming advertised routes will be cleared.
prefix-filter	Specifies that a prefix-list will be sent, by the ORF mechanism, to those neighbors with which the ORF capability has been negotiated. The neighbors will be triggered to resend updates, which match the prefix-list filter, to the local router. The local router will then perform a soft reconfiguration.
out	Indicates that outgoing advertised routes will be cleared.
soft in	Soft inbound reset causes the neighbors to resend all their updates to the local switch, without resetting the connection or clearing the entries in the local switch. So, the local switch stores new updates, and uses them to systematically replace existing table entries. This process can use a considerable amount of memory.
soft out	Soft outbound reset causes the switch to simply resend all its updates to the specified neighbor(s), without resetting the connection, or clearing table entries.

Mode Privileged Exec

Examples

```
awplus# clear ip bgp *
awplus# clear ip bgp * ipv4 unicast in prefix-filter
```

clear ip bgp (ip address)

Use this command to reset the IPv4 BGP connection to the peer specified by the IP address.

Syntax

```
clear ip bgp <ip-address>
clear ip bgp <ip-address> in [prefix-filter]
clear ip bgp <ip-address> out
clear ip bgp <ip-address> soft [in|out]
clear ip bgp <ip-address> ipv4 {unicast|multicast}
clear ip bgp <ip-address> ipv4 {unicast|multicast} in [prefix-filter]
clear ip bgp <ip-address> ipv4 {unicast|multicast} out
clear ip bgp <ip-address> ipv4 {unicast|multicast} soft [in|out]
```

Parameter	Description
<ip-address>	Specifies the IPv4 address of the neighbor whose connection is to be reset, entered in the form A.B.C.D.
ipv4	Clears all IPv4 address family peers. Configure parameters relating to the BGP exchange of IPv4 prefixes.
in	Indicates that incoming advertised routes will be cleared.
prefix-filter	Specifies that a prefix-list will be sent, by the ORF mechanism, to those neighbors with which the ORF capability has been negotiated. The neighbors will be triggered to resend updates, which match the prefix-list filter, to the local router. The local router will then perform a soft reconfiguration.
out	Indicates that outgoing advertised routes will be cleared.
soft in	Soft inbound reset causes the neighbors to resend all their updates to the local switch, without resetting the connection or clearing the entries in the local switch. So, the local switch stores new updates, and uses them to systematically replace existing table entries. This process can use a considerable amount of memory.
soft out	Soft outbound reset causes the switch to simply resend all its updates to the specified neighbor(s), without resetting the connection, or clearing table entries.
unicast	unicast address family modifier. Configure parameters relating to the BGP exchange of routes to unicast destinations.
multicast	multicast address family modifier. Configure parameters relating to the BGP exchange of routes to multicast sources.

Mode Privileged Exec

Examples

```
awplus# clear ip bgp 192.0.2.12 soft
awplus# clear ip bgp 192.0.2.5 ipv4 unicast out
awplus# clear ip bgp 192.0.2.11
```

clear ip bgp dampening

Use this command to clear route dampening information and unsuppress routes that have been suppressed routes.

Syntax `clear ip bgp dampening [<ip-address>|<ip-address/m>]`
`clear ip bgp ipv4 {unicast|multicast} dampening [<ip-address>|<ip-address/m>]`

Parameter	Description
<ip-address>	Specifies the IPv4 address for which BGP dampening is to be cleared, in dotted decimal format.
<ip-address/m>	Specifies the IPv4 address with mask for which BGP dampening is to be cleared, entered in the form A.B.C.D/M. Where M is the subnet mask
ipv4	Clears all IPv4 address family peers. Configure parameters relating to the BGP exchange of IPv4 prefixes.
unicast	Unicast address family modifier. Configure parameters relating to the BGP exchange of routes to unicast destinations.
multicast	Multicast address family modifier. Configure parameters relating to the BGP exchange of routes to multicast sources.

Mode Privileged Exec

Examples

```
awplus# clear ip bgp dampening 10.10.0.121
awplus# clear ip bgp ipv4 unicast dampening
```

clear ip bgp flap-statistics

Use this command to clear the flap count and history duration for the specified prefixes.

Syntax `clear ip bgp flap-statistics [<ip-address>|<ip-address/m>]`
`clear ip bgp ipv4 {unicast|multicast} flap-statistics [<ip-address>|<ip-address/m>]`

Parameter	Description
<ip-address>	Specifies the IPv4 address for which BGP flap count and history duration are to be cleared.
<ip-address/m>	Specifies the IPv4 address with mask for which BGP flap count and history duration are to be cleared.
ipv4	Clears all IPv4 address family peers. Configure parameters relating to the BGP exchange of IPv4 prefixes.
unicast	Unicast address family modifier. Configure parameters relating to the BGP exchange of routes to unicast destinations.
multicast	Multicast address family modifier. Configure parameters relating to the BGP exchange of routes to multicast sources.

Mode Privileged Exec

Examples

```
awplus# clear ip bgp flap-statistics 10.10.0.121
awplus# clear ip bgp ipv4 unicast flap-statistics
```

clear ip bgp (ASN)

Use this command to reset the BGP connections to all peers in a specified Autonomous System Number (ASN).

Syntax

```
clear ip bgp <asn>
clear ip bgp <asn> in [prefix-filter]
clear ip bgp <asn> out
clear ip bgp <asn> soft [in|out]
clear ip bgp <asn> ipv4 {unicast|multicast}
clear ip bgp <asn> ipv4 {unicast|multicast} in [prefix-filter]
clear ip bgp <asn> ipv4 {unicast|multicast} out
clear ip bgp <asn> ipv4 {unicast|multicast} soft [in|out]
```

Parameter	Description
<asn>	<1-65535> Specifies the ASN for which all routes will be cleared.
ipv4	Clears all IPv4 address family peers. Configure parameters relating to the BGP exchange of IPv4 prefixes.
in	Indicates that incoming advertised routes will be cleared.
prefix-filter	Specifies that a prefix-list will be sent, by the ORF mechanism, to those neighbors with which the ORF capability has been negotiated. The neighbors will be triggered to resend updates, which match the prefix-list filter, to the local router. The local router will then perform a soft reconfiguration.
out	Indicates that outgoing advertised routes will be cleared.
soft in	Soft inbound reset causes the neighbors to resend all their updates to the local switch, without resetting the connection or clearing the entries in the local switch. So, the local switch stores new updates, and uses them to systematically replace existing table entries. This process can use a considerable amount of memory.
soft out	Soft outbound reset causes the switch to simply resend all its updates to the specified neighbor(s), without resetting the connection, or clearing table entries.
unicast	Unicast address family modifier. Configure parameters relating to the BGP exchange of routes to unicast destinations.
multicast	Multicast address family modifier. Configure parameters relating to the BGP exchange of routes to multicast sources.

Mode Privileged Exec

Examples

```
awplus# clear ip bgp 100
```

```
awplus# clear ip bgp 200 ipv4 unicast in prefix-filter
```

clear ip bgp external

Use this command to reset the BGP connections to all external peers.

Syntax

```
clear ip bgp external
clear ip bgp external in [prefix-filter]
clear ip bgp external out
clear ip bgp external soft [in|out]
clear ip bgp external ipv4 {unicast|multicast}
clear ip bgp external ipv4 {unicast|multicast} in [prefix-filter]
clear ip bgp external ipv4 {unicast|multicast} out
clear ip bgp external ipv4 {unicast|multicast} soft [in|out]
```

Parameter	Description
external	Clears all external peers.
ipv4	Clears all IPv4 address family peers. Configure parameters relating to the BGP exchange of IPv4 prefixes.
in	Indicates that incoming advertised routes will be cleared.
prefix-filter	Specifies that a prefix-list will be sent, by the ORF mechanism, to those neighbors with which the ORF capability has been negotiated. The neighbors will be triggered to resend updates, which match the prefix-list filter, to the local router. The local router will then perform a soft reconfiguration.
out	Indicates that outgoing advertised routes will be cleared.
soft in	Soft inbound reset causes the neighbors to resend all their updates to the local switch, without resetting the connection or clearing the entries in the local switch. So, the local switch stores new updates, and uses them to systematically replace existing table entries. This process can use a considerable amount of memory.
soft out	Soft outbound reset causes the switch to simply resend all its updates to the specified neighbor(s), without resetting the connection, or clearing table entries.
unicast	Unicast address family modifier. Configure parameters relating to the BGP exchange of routes to unicast destinations.
multicast	Multicast address family modifier. Configure parameters relating to the BGP exchange of routes to multicast sources.

Mode Privileged Exec

Examples

```
awplus# clear ip bgp external out
awplus# clear ip bgp external ipv4 unicast in prefix-filter
```

clear ip bgp peer-group

Use this command to reset the BGP connections to all members of a peer group.

Syntax

```
clear ip bgp peer-group <peer-name>
clear ip bgp peer-group <peer-name> in [prefix-filter]
clear ip bgp peer-group <peer-name> out
clear ip bgp peer-group <peer-name> soft [in|out]
clear ip bgp peer-group <peer-name> ipv4 {unicast|multicast}
clear ip bgp peer-group <peer-name> ipv4 {unicast|multicast} in
    [prefix-filter]
clear ip bgp peer-group <peer-name> ipv4 {unicast|multicast} out
clear ip bgp peer-group <peer-name> ipv4 {unicast|multicast} soft
    [in|out]
```

Parameter	Description
peer-group	Clears all members of a peer group.
<peer-name>	Specifies the name of the peer group for which all members will be cleared.
ipv4	Clears all IPv4 address family peers. Configure parameters relating to the BGP exchange of IPv4 prefixes.
in	Indicates that incoming advertised routes will be cleared.
prefix-filter	Specifies that a prefix-list will be sent, by the ORF mechanism, to those neighbors with which the ORF capability has been negotiated. The neighbors will be triggered to resend updates, which match the prefix-list filter, to the local router. The local router will then perform a soft reconfiguration.
out	Indicates that outgoing advertised routes will be cleared.
soft in	Soft inbound reset causes the neighbors to resend all their updates to the local switch, without resetting the connection or clearing the entries in the local switch. So, the local switch stores new updates, and uses them to systematically replace existing table entries. This process can use a considerable amount of memory.
soft out	Soft outbound reset causes the switch to simply resend all its updates to the specified neighbor(s), without resetting the connection, or clearing table entries.
unicast	Unicast address family modifier. Configure parameters relating to the BGP exchange of routes to unicast destinations.
multicast	Multicast address family modifier. Configure parameters relating to the BGP exchange of routes to multicast sources.

Mode Privileged Exec

Examples

```
awplus# clear ip bgp peer-group Peer1 out
```

```
awplus# clear ip bgp peer-group mypeer ipv4 unicast in  
prefix-filter
```

clear ip bgp view

Use this command to reset connections with all the neighbors within the specified view.

The specified bgp view for this command is created using the [router bgp view](#) command.

Syntax

```
clear ip bgp view <bgp-view> *
clear ip bgp view <bgp-view> * in [prefix-filter]
clear ip bgp view <bgp-view> * out
clear ip bgp view <bgp-view> * soft [in|out]
clear ip bgp view <bgp-view> * ipv4 {unicast|multicast}
clear ip bgp view <bgp-view> * ipv4 {unicast|multicast} in [prefix-filter]
clear ip bgp view <bgp-view> * ipv4 {unicast|multicast} out
clear ip bgp view <bgp-view> * ipv4 {unicast|multicast} soft [in|out]
```

Parameter	Description
view	Specifies BGP view.
<bgp-view>	Specifies the name of the view for which all routes will be cleared.
*	Clears all peers.
ipv4	Clears all IPv4 address family peers. Configure parameters relating to the BGP exchange of IPv4 prefixes.
in	Indicates that incoming advertised routes will be cleared.
prefix-filter	Specifies that a prefix-list will be sent, by the ORF mechanism, to those neighbors with which the ORF capability has been negotiated. The neighbors will be triggered to resend updates, which match the prefix-list filter, to the local router. The local router will then perform a soft reconfiguration.
out	Indicates that outgoing advertised routes will be cleared.
soft in	Soft inbound reset causes the neighbors to resend all their updates to the local switch, without resetting the connection or clearing the entries in the local switch. So, the local switch stores new updates, and uses them to systematically replace existing table entries. This process can use a considerable amount of memory.
soft out	Soft outbound reset causes the switch to simply resend all its updates to the specified neighbor(s), without resetting the connection, or clearing table entries.
unicast	Unicast address family modifier. Configure parameters relating to the BGP exchange of routes to unicast destinations.
multicast	Multicast address family modifier. Configure parameters relating to the BGP exchange of routes to multicast sources.

Mode Privileged Exec

Examples

```
awplus# clear ip bgp view I4 * in prefix-filter
awplus# clear ip bgp view I2 ipv4 unicast soft in
```

Related Commands [router bgp view](#)

debug bgp

Use this command to turn on one or more BGP debug options.

Use the **no** variant of this command to disable one or more BGP debug options.

Syntax `debug bgp [all|dampening|events|filters|fsm|keepalives|nsm|<updates>]`
`no debug all bgp`
`no debug bgp [all|dampening|events|filters|fsm|keepalives|nsm|<updates>]`

Parameter	Description
all	Turns on all debugging for BGP
dampening	Specifies debugging for BGP dampening.
events	Specifies debugging for BGP events.
filters	Specifies debugging for BGP filters.
fsm	Specifies debugging for BGP Finite State Machine (FSM).
keepalives	Specifies debugging for BGP keepalives.
nsm	Specifies debugging for NSM messages.
<updates>	[in out] Specifies debugging for BGP updates.
in	Inbound updates
out	Outbound updates

Mode Privileged Exec

Usage If the command is entered with no parameters, then all debug options are enabled.

Examples

```
awplus# debug bgp
awplus# debug bgp events
```

Related Commands [show debugging bgp](#)
[undebug bgp](#)

distance (BGP)

This command sets the administrative distance for BGP routes. The switch uses this value to select between two or more routes to the same destination from two different routing protocols. The route with the smallest administrative distance value is added to the Forwarding Information Base (FIB). See [Administrative Distance in the Route Selection](#) Chapter for more information.

You can use this command to set the administrative distance:

- for each BGP route types by specifying:
`distance (BGP) <ebgp> <igbp> <local>`
- for a specific route by specifying:
`distance (BGP) <1-255> <ip-address/m> [<listname>]`

The **no** variant of this command sets the administrative distance for the route to the default for the route type.

Syntax

```
distance <1-255> <ip-address/m> [<listname>]
distance bgp <ebgp> <igbp> <local>
no distance <1-255> <ip-address/m> [<listname>]
no distance bgp <ebgp> <igbp> <local>
```

Parameter	Description
<1-255>	The administrative distance value you are setting for the route.
<ip-address/m>	The IP source prefix that you are changing the administrative distance for, entered in the form A . B . C . D / M . This is an IPv4 address in dotted decimal notation followed by a forward slash, and then the prefix length.
<listname>	The name of the access list to be applied to the administrative distance to selected routes.
<ebgp>	Specifies the administrative distance of external BGP (eBGP) routes. These are routes learnt from a neighbor out of the AS. Specify the distance as a number between 1 and 255. Default: 20
<igbp>	Specifies the administrative distance of internal BGP (iBGP) routes. These are routes learnt from a neighbor within the same AS. Specify the distance as a number between 1 and 255. Default: 200
<local>	Specifies the administrative distance of local BGP routes. These are routes redistributed from another protocol within your device. Specify the distance as a number between 1 and 255. Default: 200

Mode Router Configuration

If the administrative distance is changed, it could create inconsistency in the routing table and obstruct routing.

Examples To set the administrative distance to 34 for the route 10.10.0.0/24 in BGP 100, and use the access list "mylist" to filter the routes, use the commands:

```
awplus# configure terminal
awplus(config)# router bgp 100
awplus(config-router)# distance 34 10.10.0.0/24 mylist
```

To set BGP 100's administrative distances for eBGP routes to 34, iBGP routes to 23, and local BGP routes to 15, use the commands:

```
awplus# configure terminal
awplus(config)# router bgp 100
awplus(config-router)# distance bgp 34 23 15
```

exit-address-family

Use this command to exit the Address Family mode.

Syntax `exit-address-family`

Mode Address Family [ipv4 unicast | ipv4 multicast] mode

Example The following example shows the use of `exit-address-family` command and the change in the prompt after using this command.

```
awplus# configure terminal
awplus(config)# router bgp 100
awplus(config-router)# address-family ipv4 multicast
awplus(config-router-af)# exit-address-family
```

Related Commands [address-family](#)

ip as-path access-list

This command defines a BGP Autonomous System (AS) path access list.

The named AS path list is a filter based on regular expressions. If the regular expression matches the AS path in a BGP update message, then the permit or deny condition applies to that update. Use this command to define the BGP access list globally, then use neighbor configuration commands to apply the list to a particular neighbor.

The **no** variant of this command disables the use of the access list

Syntax `ip as-path access-list <listname> {deny|permit} <reg-exp>`
`no ip as-path access-list <listname> {deny|permit} <reg-exp>`

Parameter	Description
<listname>	Specifies the name of the access list.
deny	Denies access to matching conditions.
permit	Permits access to matching conditions.
<reg-exp>	Specifies a regular expression to match the BGP AS paths.

Regular expressions listed below can be used with the **ip as-path-access-list** command:

Symbol	Character	Meaning
^	Caret	Used to match the beginning of the input string. When used at the beginning of a string of characters, it negates a pattern match.
\$	Dollar sign	Used to match the end of the input string.
.	Period	Used to match a single character (white spaces included).
*	Asterix	Used to match none or more sequences of a pattern.
+	Plus sign	Used to match one or more sequences of a pattern.
?	Question mark	Used to match none or one occurrence of a pattern.
_	Underscore	Used to match spaces, commas, braces, parenthesis, or the beginning and end of an input string.
[]	Brackets	Specifies a range of single-characters.
-	Hyphen	Separates the end points of a range.

Mode Global Configuration

Example

```
awplus# configure terminal
awplus(config)# ip as-path access-list mylist deny ^65535$
```

ip community-list

Use this command to add an entry to a standard BGP community-list filter.

Use the **no** variant of this command to delete the community list entry.

Syntax `ip community-list <listname> {deny|permit} .<community>`
`no ip community-list <listname> {deny|permit} .<community>`

Parameter	Description
<listname>	Specifies the community listname.
deny	Specifies the community to reject.
permit	Specifies the community to accept.
.<community>	{<AS:VAL> local-AS no-advertise no-export}
<AS:VAL>	Specifies the valid value for the community number. This format represents the 32 bit communities value, where AS is the high order 16 bits and VAL is the low order 16 bits in digit format.
local-AS	Specifies routes not to be advertised to external BGP peers.
no-advertise	Specifies routes not to be advertised to other BGP peers.
no-export	Specifies routes not to be advertised outside of Autonomous System boundary.

Mode Global Configuration

Usage A community-list can be used as a filter to BGP updates. Use this command to define the community access list globally, then use neighbor configuration commands to apply the list to a particular neighbor.

There are two kinds of community-lists: expanded and standard. A standard community-list defines the community attributes explicitly and not via a regular expression. An expanded community-list defines the communities attributes with regular expressions.

The standard community-list is compiled into binary format and is directly compared with the BGP communities attribute in the BGP updates. The comparison is faster than the expanded community-list. Any community value that does not match the standard community value is automatically treated as expanded.

Example

```
awplus# configure terminal
awplus(config)# ip community-list mylist permit 7675:80 7675:90
```

Related Commands [ip community-list standard](#)
[ip community-list expanded](#)

ip community-list expanded

Use this command to add an entry to an expanded BGP community-list filter.

Use the **no** variant of this command to delete the community list entry.

Syntax

```
ip community-list <100-199> {deny|permit} .<line>
no ip community-list <100-199> {deny|permit} .<line>
ip community-list expanded <expanded-listname> {deny|permit} .<line>
no ip community-list expanded <expanded-listname> {deny|permit}
.<line>
```

Parameter	Description
<100-199>	Expanded community list number.
expanded	Specifies an expanded community list.
<expanded-listname>	Expanded community list entry.
deny	Specifies community to reject.
permit	Specifies community to accept.
.<line>	Specifies community attributes with regular expressions.

Regular expressions listed below can be used with the **ip community-list expanded** command:

Symbol	Character	Meaning
^	Caret	Used to match the beginning of the input string. When used at the beginning of a string of characters, it negates a pattern match.
\$	Dollar sign	Used to match the end of the input string.
.	Period	Used to match a single character (white spaces included).
*	Asterix	Used to match none or more sequences of a pattern.
+	Plus sign	Used to match one or more sequences of a pattern.
?	Question mark	Used to match none or one occurrence of a pattern.
_	Underscore	Used to match spaces, commas, braces, parenthesis, or the beginning and end of an input string.
[]	Brackets	Specifies a range of single-characters.
-	Hyphen	Separates the end points of a range.

Mode Global Configuration

Usage A `community-list` can be used as a filter to BGP updates. Use this command to define the community access list globally, then use `neighbor` configuration commands to apply the list to a particular neighbor.

There are two kinds of community-lists: expanded and standard. A standard community-list defines the community attributes explicitly and not via a regular expression. An expanded community-list defines the communities attributes with regular expressions.

The standard community-list is compiled into binary format and is directly compared with the BGP communities attribute in the BGP updates. The comparison is faster than the expanded community-list. Any community value that does not match the standard community value is automatically treated as expanded.

Examples

```
awplus# configure terminal
awplus(config)# ip community-list 125 permit 6789906
awplus(config)# ip community-list expanded CLIST permit .*
```

Related Commands [ip community-list](#)
[ip community-list standard](#)

ip community-list standard

Use this command to add an entry to a standard BGP community-list filter.

Use the **no** variant of this command to delete the standard community-list entry.

Syntax

```
ip community-list <1-99> {deny|permit} [.<community>]
no ip community-list <1-99> {deny|permit} [.<community>]
ip community-list standard <standard-listname> {deny|permit}
    [.<community>]
no ip community-list standard <standard-listname> {deny|permit}
    [.<community>]
```

Parameter	Description
<1-99>	Standard community list number.
standard	Specifies a standard community list.
<standard-listname>	Standard community list entry.
deny	Specifies community to reject.
permit	Specifies community to accept.
<community>	{ <AS:VAL> local-AS no-advertise no-export }
<AS:VAL>	Specifies the valid value for the community number. This format represents the 32 bit communities value, where AS is the high order 16 bits and VAL is the low order 16 bits in digit format.
local-AS	Specifies routes not to be advertised to external BGP peers.
no-advertise	Specifies routes not to be advertised to other BGP peers.
no-export	Specifies routes not to be advertised outside of the Autonomous System boundary.

Mode Global Configuration

Usage A community-list can be used as a filter to BGP updates. Use this command to define the community access list globally, then use neighbor configuration commands to apply the list to a particular neighbor.

There are two kinds of community-lists: expanded and standard. The standard community-list defines the community attributes as explicit values, without regular expressions. The expanded community-list defines the communities attributes with regular expressions.

The standard community-list is compiled into binary format and is directly compared with the BGP communities attribute in the BGP updates. The comparison is faster than the expanded community-list. Any community value that does not match the standard community value is automatically treated as expanded.

Examples

```
awplus# configure terminal
awplus(config)# ip community-list standard CLIST permit 7675:80
7675:90 no-export
awplus(config)# ip community-list 34 permit 5675:50 no-
advertise
```

Related Commands [ip community-list](#)
[ip community-list expanded](#)

ip extcommunity-list expanded

Use this command to create or delete an expanded extended community list.

Use the **no** variant of this command to delete the expanded extended community-list entry.

Syntax

```
ip extcommunity-list <100-199> {deny|permit}
  {.<line>|.<AS:NN>|.<ip-address>}

no ip extcommunity-list <100-199> {deny|permit}
  {.<line>|.<AS:NN>|.<ip-address>}

ip extcommunity-list expanded <expanded-listname> {deny|permit}
  {.<line>|.<AS:NN>|.<ip-address>}

no ip extcommunity-list expanded <expanded-listname> {deny|permit}
  {.<line>|.<AS:NN>|.<ip-address>}

no ip extcommunity-list <100-199>

no ip extcommunity-list expanded <expanded-listname>
```

Parameter	Description
<100-199>	Expanded extcommunity list number.
expanded	Specifies an expanded extcommunity list.
<expanded-listname>	Expanded extcommunity list entry.
deny	Specifies the extcommunity to reject.
permit	Specifies the extcommunity to accept.
.<line>	Specifies extcommunity attributes with regular expression.
<AS:NN>	Specifies the valid value for an extcommunity number. This format represents the 32 bit extcommunities value, where AA is the high order 16 bits and NN is the low order 16 bits in digit format.
<ip-address>	Specifies the IP address to deny or permit.

Regular expressions listed below are used with the **ip extcommunity-list expanded** command:

Symbol	Character	Meaning
^	Caret	Used to match the beginning of the input string. When used at the beginning of a string of characters, it negates a pattern match.
\$	Dollar sign	Used to match the end of the input string.
.	Period	Used to match a single character (white spaces included).
*	Asterix	Used to match none or more sequences of a pattern.
+	Plus sign	Used to match one or more sequences of a pattern.
?	Question mark	Used to match none or one occurrence of a pattern.

Symbol (cont.)	Character (cont.)	Meaning (cont.)
_	Underscore	Used to match spaces, commas, braces, parenthesis, or the beginning and end of an input string.
[]	Brackets	Specifies a range of single-characters.
-	Hyphen	Separates the end points of a range.

Mode Global Configuration

Examples

```
awplus# configure terminal
awplus(config)# ip extcommunity-list 125 permit 4567335
awplus(config)# ip extcommunity-list expanded CLIST permit .*
```

Related Commands [ip extcommunity-list standard](#)

ip extcommunity-list standard

Use this command to create and delete a standard extended community list.

Use the **no** variant of this command to delete a standard extended community-list entry.

Syntax

```
ip extcommunity-list <1-99> {deny|permit} {rt|soo}
  <community-number>

no ip extcommunity-list standard <standard-listname> {deny|permit}
  {rt|soo} <community-number>

no ip extcommunity-list <1-99>

no ip extcommunity-list standard <standard-listname>
```

Parameter	Description
<1-99>	Standard extcommunity list number.
standard	Specifies a standard extended community list.
<standard-listname>	Standard extended community list entry.
deny	Specifies the extended community to reject.
permit	Specifies the extended community to accept.
rt	Specifies the route target of the extended community.
soo	Specifies the site of origin of the extended community.
<community-number>	Specifies the valid value for an extended community number. This can be one of two formats: <ul style="list-style-type: none"> ■ <ASN:NN> where ASN is an AS (Autonomous System) number and NN is a value chosen by the ASN administrator ■ <A.B.C.D:NN> where A.B.C.D is an IPv4 address, and NN is a value chosen by the ASN administrator. Note that ASN and NN are both integers from 1 to 65535. AS numbers are assigned to the regional registries by IANA (www.iana.org) and must be obtained in your region.

Mode Global Configuration

Examples

```
awplus# configure terminal

awplus(config)# ip extcommunity-list 36 permit rt 5675:50

awplus(config)# ip extcommunity-list standard CLIST permit soo
7645:70
```

```
awplus# configure terminal
awplus(config)# ip extcommunity-list 36 deny rt 192.168.1.1:70
awplus(config)# ip extcommunity-list standard CLIST deny soo
10.10.1.1:50
```

Related Commands [ip extcommunity-list expanded](#)
[show ip extcommunity-list](#)

neighbor activate

Use this command to enable the exchange of routes with a neighboring router, possibly within a specific address-family.

Use the **no** variant of this command to disable exchange of information with a neighbor.

Syntax `neighbor <neighborid> activate`
`no neighbor <neighborid> activate`

Parameter	Description
<neighborid>	{<ip-address> <tag>}
<ip-address>	The address of an IPv4 BGP neighbor, in dotted decimal notation A.B.C.D.
<tag>	Name of an existing peer-group. For information on how to create peer groups, refer to the neighbor peer-group (adding a neighbor) command on page 38.93 , and neighbor remote-as command on page 38.97 . When this parameter is used with a command, the command applies on all peers in the specified group.

Mode Router Configuration

Usage This command triggers the switch to start a BGP peering relationship with the specified neighbor and start exchanging routes with that neighbor. To enable the exchange of multicast NLRIs (Network Layer Reachability Information), neighbors are activated using the neighbor activate command in multicast address family mode.

Examples To enable an exchange of routes with a neighboring router enter the commands shown below:

```
awplus# configure terminal
awplus(config)# router bgp 10
awplus(config-router)# neighbor 1.2.3.4 activate
```

To enable an exchange of multicast NLRI (Network Layer Reachability Information) with a neighboring router enter the commands shown below:

```
awplus# configure terminal
awplus(config)# router bgp 100
awplus(config-router)# address-family ipv4 multicast
awplus(config-router-af)# neighbor 10.10.10.0 activate
```

Related Commands [neighbor remote-as](#)

neighbor advertisement-interval

Use this command to set the minimum interval between sending the BGP routing updates.

Use the **no** variant of this command to set the interval time to the default.

Syntax `neighbor <neighborid> advertisement-interval <time>`
`no neighbor <neighborid> advertisement-interval [<time>]`

Parameter	Description
<code><neighborid></code>	{ <code><ip-address></code> <code><tag></code> }
<code><ip-address></code>	The address of an IPv4 BGP neighbor, in dotted decimal notation A.B.C.D.
<code><tag></code>	Name of an existing peer-group. For information on how to create peer groups, refer to the neighbor peer-group (adding a neighbor) command on page 38.93 , and neighbor remote-as command on page 38.97 . When this parameter is used with a command, the command applies on all peers in the specified group.
<code><time></code>	<code><1-600></code> Advertise -interval value in seconds.

Default The default minimum interval between sending the BGP routing updates is 30 seconds.

Mode Router Configuration

Usage Use this command to set the minimum interval between the sending of BGP routing updates. To reduce the flapping of routes to internet, a minimum advertisement interval is set, so that the BGP routing updates are sent only per interval seconds. BGP dampening can also be used to control the effects of flapping routes.

Example

```
awplus# configure terminal
awplus(config)# router bgp 10
awplus(config-router)# neighbor 10.10.0.3 advertisement-
interval 45
```

neighbor allowas-in

Use this command to accept an AS-path with the specified Autonomous System (AS) number from inbound updates.

Use the **no** variant of this command to revert to default.

Syntax `neighbor <neighborid> allowas-in <occurrences>`
`no neighbor <neighborid> allowas-in`

Parameter	Description
<code><neighborid></code>	<code>{<ip-address> <tag>}</code>
<code><ip-address></code>	The address of an IPv4 BGP neighbor, in dotted decimal notation A.B.C.D.
<code><tag></code>	Name of an existing peer-group. For information on how to create peer groups, refer to the neighbor peer-group (adding a neighbor) command on page 38.93 , and neighbor remote-as command on page 38.97 . When this parameter is used with a command, the command applies on all peers in the specified group.
<code><occurrences></code>	<code><1-10></code> Specifies the number of occurrences of the AS number.

Default Disabled

Usage Use this command to configure PE routers to allow re-advertisement of all prefixes containing duplicate Autonomous System Numbers (ASNs). In a hub and spoke configuration, a PE router re-advertises all prefixes containing duplicate ASNs. Specify the remote-as or peer-group first using the related commands.

Mode Router Configuration

Examples

```
awplus# configure terminal
awplus(config)# router bgp 10
awplus(config-router)# neighbor 10.10.0.1 allowas-in 3
```

```
awplus# configure terminal
awplus(config)# router bgp 10
awplus(config-router)# address-family ipv4
awplus(config-router-af)# neighbor 10.10.0.1 allowas-in 3
```

Related Commands [neighbor remote-as](#)
[neighbor peer-group \(creating a peer-group\)](#)

[neighbor peer-group \(adding a neighbor\)](#)

neighbor as-origination-interval

Use this command to enable the sending of AS (Autonomous System) origination routing updates to the specified neighbor. This command can also be used to adjust the rate at which the updates are sent.

Use the **no** variant of this command to disable this feature.

Syntax `neighbor <neighbor_address> as-origination-interval <time>`
`neighbor <neighbor_address> as-origination-interval`
`no neighbor <neighbor_address> as-origination-interval`

Parameter	Description
<code><neighbor_address></code>	Neighbor IP address. Use A.B.C.D form.
<code><time></code>	<code><1-600></code> time in seconds

Default Disabled

Mode Router Configuration

Usage This command is used to change the minimum interval between sending AS-origination routing updates. The interval can be from 1 to 600 seconds.

Example

```
awplus# configure terminal
awplus(config)# router bgp 100
awplus(config-router)# address-family ipv4
awplus(config-router-af)# neighbor 10.10.0.1 as-origination-
interval 10
```

Related Commands [address-family](#)

neighbor attribute-unchanged

Use this command to advertise unchanged BGP attributes to the specified neighbor.

Use the **no** variant of this command to disable this function.

Syntax `neighbor <neighborid> attribute-unchanged {as-path|next-hop|med}`
`no neighbor <neighborid> attribute-unchanged {as-path|next-hop|med}`

Parameter	Description
<code><neighborid></code>	<code>{<ip-address> <tag>}</code>
<code><ip-address></code>	The address of an IPv4 BGP neighbor, in dotted decimal notation A.B.C.D.
<code><tag></code>	Name of an existing peer-group. For information on how to create peer groups, refer to the neighbor peer-group (adding a neighbor) command on page 38.93 , and neighbor remote-as command on page 38.97 . When this parameter is used with a command, the command applies on all peers in the specified group.
<code>as-path</code>	AS path attribute.
<code>next-hop</code>	Next hop attribute.
<code>med</code>	Multi Exit Discriminator.

Mode Router Configuration

Example

```
awplus# configure terminal
awplus(config)# router bgp 10
awplus(config-router)# neighbor 10.10.0.75 attribute-unchanged
as-path med
```

neighbor capability dynamic

Use this command to enable the dynamic capability for a specific peer.

Use the **no** variant of this command to disable the dynamic capability.

Syntax `neighbor <neighborid> capability dynamic`
`no neighbor <neighborid> capability dynamic`

Parameter	Description
<code><neighborid></code>	<code>{<ip-address> <tag>}</code>
<code><ip-address></code>	The address of an IPv4 BGP neighbor, in dotted decimal notation A.B.C.D.
<code><tag></code>	Name of an existing peer-group. For information on how to create peer groups, refer to the neighbor peer-group (adding a neighbor) command on page 38.93 , and neighbor remote-as command on page 38.97 . When this parameter is used with a command, the command applies on all peers in the specified group.

Default Disabled

Mode Router Configuration

Usage This command allows a BGP speaker to advertise or withdraw an address family capability to a peer in a non-disruptive manner.

Example

```
awplus# configure terminal
awplus(config)# router bgp 10
awplus(config-router)# neighbor 10.10.10.1 capability dynamic
```

neighbor capability graceful-restart

Use this command to configure the device to advertise the Graceful Restart Capability to the neighbors.

Use the **no** variant of this command to configure the device so it does not advertise the Graceful Restart Capability to its neighbor.

Syntax `neighbor <neighborid> capability graceful-restart`
`no neighbor <neighborid> capability graceful-restart`

Parameter	Description
<code><neighborid></code>	{ <code><ip-address></code> <code><tag></code> }
<code><ip-address></code>	The address of an IPv4 BGP neighbor, in dotted decimal notation A.B.C.D.
<code><tag></code>	Name of an existing peer-group. For information on how to create peer groups, refer to the neighbor peer-group (adding a neighbor) command on page 38.93 , and neighbor remote-as command on page 38.97 . When this parameter is used with a command, the command applies on all peers in the specified group.

Default Disabled

Mode Router Configuration

Usage This configuration only indicates BGP speaker has the ability to preserve its forwarding state for some address family when BGP restarts.

Use the **neighbor capability graceful-restart** command to advertise to the neighbor routers the capability of graceful restart. First specify neighbors **remote-as** identification number assigned by the neighbor router.

The graceful restart capability is advertised only when the graceful restart capability has been enabled using the [bgp graceful-restart command on page 38.26](#).

Example

```
awplus# configure terminal
awplus(config)# router bgp 10
awplus(config-router)# neighbor 10.10.10.50 capability
graceful-restart
```

Related Commands [bgp graceful-restart](#)

neighbor capability orf prefix-list

Use this command to advertise ORF capability to neighbors.

Use the **no** variant of this command to disable this function.

Syntax `neighbor <neighborid> capability orf prefix-list {both|receive|send}`
`no neighbor <neighborid> capability orf prefix-list {both|receive|send}`

Parameter	Description
<code><neighborid></code>	<code>{<ip-address> <tag>}</code>
	<code><ip-address></code> The address of an IPv4 BGP neighbor, in dotted decimal notation A.B.C.D.
	<code><tag></code> Name of an existing peer-group. For information on how to create peer groups, refer to the neighbor peer-group (adding a neighbor) command on page 38.93 , and neighbor remote-as command on page 38.97 . When this parameter is used with a command, the command applies on all peers in the specified group.
<code>orf</code>	Advertises ORF capability to its neighbors
<code>both</code>	Indicates that the local router can send ORF entries to its peer as well as receive ORF entries from its peer.
<code>receive</code>	Indicates that the local router is willing to receive ORF entries from its peer
<code>send</code>	Indicates that the local router is willing to send ORF entries to its peer

Mode Router Configuration

Usage Outbound Route Filters (ORFs) send and receive capabilities to lessen the number of updates exchanged between neighbors. By filtering updates, this option minimizes generating and processing of updates. The local router advertises the ORF capability in **send** mode and the remote router receives the ORF capability in **receive** mode applying the filter as outbound policy. The two routers exchange updates to maintain the ORF for each router. Only an individual router or a peer-group can be configured to be in **receive** or **send** mode. A peer-group member cannot be configured to be in **receive** or **send** mode

Example

```
awplus# configure terminal
awplus(config)# router bgp 10
awplus(config-router)# neighbor 10.10.0.5 capability orf
prefix-list both
```

neighbor capability route-refresh

Use this command to advertise route-refresh capability to the specified neighbors.

Use the **no** variant of this command to disable this function

Syntax `neighbor <neighborid> capability route-refresh`
`no neighbor <neighborid> capability route-refresh`

Parameter	Description
<neighborid>	{<ip-address> <tag>}
<ip-address>	The address of an IPv4 BGP neighbor, in dotted decimal notation A.B.C.D.
<tag>	Name of an existing peer-group. For information on how to create peer groups, refer to the neighbor peer-group (adding a neighbor) command on page 38.93 , and neighbor remote-as command on page 38.97 . When this parameter is used with a command, the command applies on all peers in the specified group.

Mode Router Configuration

Usage Use this command to advertise to peer about route refresh capability support. If route refresh capability is supported, then router can dynamically request that the peer readvertises its Adj-RIB-Out.

Example

```
awplus# configure terminal
awplus(config)# router bgp 10
awplus(config-router)# neighbor 10.10.10.1 capability route-
refresh
```

neighbor collide-established

Use this command to specify including a neighbor, already in an 'established' state, for conflict resolution when a TCP connection collision is detected.

Use the **no** variant of this command to remove a neighbor, already in an 'established' state, for conflict resolution when a TCP connection collision is detected.

Syntax `neighbor <neighborid> collide-established`
`no neighbor <neighborid> collide-established`

Parameter	Description
<code><neighborid></code>	<code>{<ip-address> <tag>}</code>
	<code><ip-address></code> The address of an IPv4 BGP neighbor, in dotted decimal notation A.B.C.D.
	<code><tag></code> Name of an existing peer-group. For information on how to create peer groups, refer to the neighbor peer-group (adding a neighbor) command on page 38.93 , and neighbor remote-as command on page 38.97 . When this parameter is used with a command, the command applies on all peers in the specified group.

Mode Router Configuration

Usage This command must be used only when specially required. It is not required in most network deployments.

The associated functionality of including an 'established' neighbor into TCP connection collision conflict resolution is automatically enabled when neighbor is configured for BGP graceful-restart.

Example

```
awplus# configure terminal
awplus(config)# router bgp 10
awplus(config-router)# neighbor 3.3.3.3 collide-established
```

neighbor connection-retry-time

Use this command to set the connection retry time for a specific BGP neighbor.

Use the **no** variant of this command to clear the connection retry time for a specific BGP neighbor.

Syntax `neighbor {<neighborid>} connection-retry-time <1-65535>`
`no neighbor {<neighborid>} connection-retry-time`

Parameter	Description
<neighborid>	{<ip-address> <tag>}
<ip-address>	The address of an IPv4 BGP neighbor, in dotted decimal notation A.B.C.D.
<tag>	Name of an existing peer-group. For information on how to create peer groups, refer to the neighbor peer-group (adding a neighbor) command on page 38.93 , and neighbor remote-as command on page 38.97 . When this parameter is used with a command, the command applies on all peers in the specified group.
<1-65535>	The connection retry time in seconds.

Mode Router Configuration

Example To set the connection retry time of 125 seconds for the BGP neighbor with the IP address of 10.10.10.10, enter the command:

```
awplus# configure terminal
awplus(config)# router bgp 12
awplus(config-router)# neighbor 10.10.10.10 connection-retry-time 125
```

Related Commands [neighbor peer-group \(adding a neighbor\)](#)
[neighbor remote-as](#)

neighbor default-originate

Use this command to allow a BGP local router to send the default route 0.0.0.0 to a neighbor.

Use the **no** variant of this command to send no route as a default.

Syntax `neighbor {<neighborid>} default-originate [route-map <routemap-name>]`
`no neighbor {<neighborid>} default-originate [route-map <routemap-name>]`

Parameter	Description
<code><neighborid></code>	<code>{<ip-address> <tag>}</code>
<code><ip-address></code>	The address of an IPv4 BGP neighbor, in dotted decimal notation A.B.C.D.
<code><tag></code>	Name of an existing peer-group. For information on how to create peer groups, refer to the neighbor peer-group (adding a neighbor) command on page 38.93 , and neighbor remote-as command on page 38.97 . When this parameter is used with a command, the command applies on all peers in the specified group.
<code>route-map</code>	If a route-map is specified, then the route table must contain at least one route that matches the permit criteria of the route map before the default route will be advertised to the specified neighbor.
<code><routemap-name></code>	Route-map name.

Mode Router Configuration

Example

```
awplus# configure terminal
awplus(config)# router bgp 10
awplus(config-router)# neighbor 10.10.10.1 default-originate
route-map myroute
```

neighbor description

Use this command to associate a description with a neighbor.

Use the **no** variant of this command to remove the description.

Syntax `neighbor <neighborid> description <description>`
`no neighbor <neighborid> description [<description>]`

Parameter	Description
<code><neighborid></code>	{ <code><ip-address></code> <code><tag></code> }
<code><ip-address></code>	The address of an IPv4 BGP neighbor, in dotted decimal notation A.B.C.D.
<code><tag></code>	Name of an existing peer-group. For information on how to create peer groups, refer to the neighbor peer-group (adding a neighbor) command on page 38.93 , and neighbor remote-as command on page 38.97 . When this parameter is used with a command, the command applies on all peers in the specified group.
<code><description></code>	Up to 80 characters of text describing the neighbor.

Mode Router Configuration

Example

```
awplus# configure terminal
awplus(config)# router bgp 10
awplus(config-router)# neighbor 1.2.3.4 description Backup
router for sales.
```

neighbor disallow-infinite-holdtime

Use this command to disallow the configuration of infinite holdtime.

Use the **no** variant of this command to allow the configuration of infinite holdtime.

Syntax `neighbor {<ip-address>} disallow-infinite-holdtime`
`no neighbor {<ip-address>} disallow-infinite-holdtime`

Parameter	Description
<code><ip-address></code>	The address of an IPv4 BGP neighbor, in dotted decimal notation A.B.C.D.

Mode Router Configuration

Usage This command enables the local BGP speaker to reject holdtime "0" seconds from the peer during exchange of open messages or the user during configuration.

The **no** variant of this command allows the BGP speaker to accept "0" holdtime from the peer or during configuration.

Example To enable the **disallow-infinite-holdtime** feature on the BGP speaker with the IP address of 10.10.10.10, enter the command:

```
awplus# configure terminal
awplus(config)# router bgp 10
awplus(config-router)# neighbor 10.11.4.26 disallow-infinite-holdtime
```

Related Commands [neighbor timers](#)
[timers \(BGP\)](#)

neighbor distribute-list

This command filters route update from a particular BGP neighbor using an access control list.

You can add one incoming and one outgoing distribute-list for each BGP neighbor.

The **no** variant of this command removes a previously configured distribute-list.

Syntax `neighbor <neighborid> distribute-list <access-list> {in|out}`
`no neighbor <neighborid> distribute-list <access-list> {in|out}`

Parameter	Description
<code><neighborid></code>	Identification method for the BGP peer. Use one of the following formats:
<code><ip-address></code>	The address of an IPv4 BGP neighbor, in dotted decimal notation <i>A.B.C.D</i> .
<code><tag></code>	Name of an existing peer-group. For information on how to create peer groups, refer to the neighbor peer-group (adding a neighbor) and neighbor remote-as commands. When this parameter is used with a command, the command applies on all peers in the specified group.
<code><access-list></code>	The specific access-list used to filter routes. Specify one of the following types of access-lists:
<code><WORD></code>	The name of IP access-list.
<code><1-199></code>	The ID number of a standard IP access-list.
<code><1300-2699></code>	The ID number of an extended IP access-list.
<code>in</code>	Indicates that incoming advertised routes will be filtered.
<code>out</code>	Indicates that outgoing advertised routes will be filtered.

Mode Router Configuration

Example

```
awplus# configure terminal
awplus(config)# router bgp 10
awplus(config-router)# neighbor 1.2.3.4 distribute-list
mylist out
```

neighbor dont-capability-negotiate

Use this command to disable capability negotiation.

The capability negotiation is performed by default. This command is used to allow compatibility with older BGP versions that have no capability parameters used in open messages between peers.

Use the **no** variant of this command to enable capability negotiation.

Syntax `neighbor <neighborid> dont-capability-negotiate`
`no neighbor <neighborid> dont-capability-negotiate`

Parameter	Description
<code><neighborid></code>	<code>{<ip-address> <tag>}</code>
<code><ip-address></code>	Specifies the address of the BGP neighbor in IPv4 format <i>A.B.C.D</i> .
<code><tag></code>	Name of an existing peer-group. For information on how to create peer groups, refer to the neighbor peer-group (adding a neighbor) command on page 38.93 , and neighbor remote-as command on page 38.97 . When this parameter is used with a command, the command applies on all peers in the specified group.

Mode Router Configuration

Example

```
awplus# configure terminal
awplus(config)# router bgp 10
awplus(config-router)# neighbor 10.10.0.34 dont-capability-
negotiate
```

neighbor ebgp-multihop

Use this command to accept and attempt BGP connections to external peers on indirectly connected networks.

The switch will not establish a connection to a multihop neighbor, if the only route to the multihop peer is a default route.

Use the **no** variant of this command to return to the default.

Syntax `neighbor <neighborid> ebgp-multihop [<count>]`
`no neighbor <neighborid> ebgp-multihop [<count>]`

Parameter	Description
<code><neighborid></code>	<code>{<ip-address> <tag>}</code>
<code><ip-address></code>	The address of an IPv4 BGP neighbor, in dotted decimal notation A.B.C.D.
<code><tag></code>	Name of an existing peer-group. For information on how to create peer groups, refer to the neighbor peer-group (adding a neighbor) command on page 38.93 , and neighbor remote-as command on page 38.97 . When this parameter is used with a command, the command applies on all peers in the specified group.
<code><count></code>	<code><1-255></code> Maximum hop count that appears TTL field of the BGP packets. If the maximum hop count is not set the hop count is 255.

Mode Router Configuration

Example

```
awplus# configure terminal
awplus(config)# router bgp 10
awplus(config-router)# neighbor 10.10.10.34 remote-as 20
awplus(config-router)# neighbor 10.10.10.34 ebgp-multihop 5
```

neighbor enforce-multihop

Use this command to enforce the requirement that BGP neighbors form multihop connections.

Use the **no** variant of this command to turn off this feature.

Syntax `neighbor <neighborid> enforce-multihop`
`no neighbor <neighborid> enforce-multihop`

Parameter	Description
<code><neighborid></code>	{ <code><ip-address></code> <code><tag></code> }
<code><ip-address></code>	The address of an IPv4 BGP neighbor, in dotted decimal notation A.B.C.D.
<code><tag></code>	Name of an existing peer-group. For information on how to create peer groups, refer to the neighbor peer-group (adding a neighbor) command on page 38.93 , and neighbor remote-as command on page 38.97 . When this parameter is used with a command, the command applies on all peers in the specified group.

Mode Router Configuration

Example

```
awplus# configure terminal
awplus(config)# router bgp 10
awplus(config-router)# neighbor 10.10.0.34 remote-as 20
awplus(config-router)# neighbor 10.10.0.34 enforce-multihop
```

neighbor filter-list

This command creates a BGP filter using an AS (Autonomous System) path list. This command specifies an AS path list, which it then applies to filter updates to and from a BGP neighbor

The **no** variant of this command removes the previously specified filter using access control lists.

Syntax `neighbor <neighborid> filter-list <listname> {in|out}`
`no neighbor <neighborid> filter-list <listname> {in|out}`

Parameter	Description				
<code><neighborid></code>	Identification method for the BGP peer. Use one of the following formats: <table border="1" data-bbox="657 705 1426 1064"> <tbody> <tr> <td><code><ip-address></code></td> <td>The address of an IPv4 BGP neighbor, in dotted decimal notation A.B.C.D.</td> </tr> <tr> <td><code><tag></code></td> <td>Name of an existing peer-group. For information on how to create peer groups, refer to the neighbor peer-group (adding a neighbor) command on page 38.93, and neighbor remote-as command on page 38.97. When this parameter is used with a command, the command applies on all peers in the specified group.</td> </tr> </tbody> </table>	<code><ip-address></code>	The address of an IPv4 BGP neighbor, in dotted decimal notation A.B.C.D.	<code><tag></code>	Name of an existing peer-group. For information on how to create peer groups, refer to the neighbor peer-group (adding a neighbor) command on page 38.93 , and neighbor remote-as command on page 38.97 . When this parameter is used with a command, the command applies on all peers in the specified group.
<code><ip-address></code>	The address of an IPv4 BGP neighbor, in dotted decimal notation A.B.C.D.				
<code><tag></code>	Name of an existing peer-group. For information on how to create peer groups, refer to the neighbor peer-group (adding a neighbor) command on page 38.93 , and neighbor remote-as command on page 38.97 . When this parameter is used with a command, the command applies on all peers in the specified group.				
<code><listname></code>	The name of an AS (Autonomous System) path list.				
<code>in</code>	Indicates that incoming advertised routes will be filtered.				
<code>out</code>	Indicates that outgoing advertised routes will be filtered.				

Mode Router Configuration

Usage This command specifies a filter for updates based on a BGP AS (Autonomous System) path list.

Example

```
awplus# configure terminal
awplus(config)# router bgp 10
awplus(config-router)# neighbor 10.10.0.34 filter-list list1
out
```

neighbor interface

Use this command to configure the interface name of a BGP-speaking neighbor.

Use the **no** variant of this command to disable this function

Syntax `neighbor <ipaddr> interface <interface>`
`no neighbor <ipaddr> interface <interface>`

Parameter	Description
<code><ipaddr></code>	Specifies the IPv4 address of the BGP neighbor - entered in dotted decimal notation.
<code><interface></code>	Specifies the interface name of BGP neighbor, e.g. vlan2.

Mode Router Configuration

Examples

```

awplus# configure terminal
awplus(config)# router bgp 10
awplus(config-router)# neighbor 10.10.0.72 interface vlan2

awplus# configure terminal
awplus(config)# router bgp 10
awplus(config-router)# no neighbor 10.10.0.72 interface vlan2

```

neighbor maximum-prefix

Use this command to control the number of prefixes that can be received from a neighbor.

Use the **no** variant of this command to disable this function. Do not specify threshold to apply the default threshold of 75% for the maximum number of prefixes before this is applied.

Syntax `neighbor <neighborid> maximum-prefix <maximum>`
`no neighbor <neighborid> maximum-prefix [<maximum>]`

Parameter	Description
<neighborid>	{<ip-address> <tag>}
<ip-address>	The address of an IPv4 BGP neighbor, in dotted decimal notation A.B.C.D.
<tag>	Name of an existing peer-group. For information on how to create peer groups, refer to the neighbor peer-group (adding a neighbor) command on page 38.93 , and neighbor remote-as command on page 38.97 . When this parameter is used with a command, the command applies on all peers in the specified group.
<maximum>	<maxprefix> [<threshold>] [warning-only]
<maxprefix>	<1-4294967295> Specifies the maximum number of prefixes permitted.
<threshold>	<1-100> Specifies the threshold value, 1 to 100 percent. 75% by default.
warning-only	Only gives a warning message when the limit is exceeded.

Default The default threshold value is 75%. If the threshold value is not specified this default is applied.

Mode Router Configuration

Usage The **neighbor maximum-prefix** command allows the configuration of a specified number of prefixes that a BGP router is allowed to receive from a neighbor. When the **warning-only** option is not used, if any extra prefixes are received, the router ends the peering. A terminated peer, stays down until the **clear ip bgp** command is used.

Example

```
awplus# configure terminal
awplus(config)# router bgp 10
awplus(config-router)# neighbor 10.10.0.72 maximum-prefix 1244
warning-only
```

neighbor next-hop-self

Use this command to configure the router as the next hop for a BGP-speaking neighbor or peer group.

Use the **no** variant of this command to disable this feature.

Syntax `neighbor <neighborid> next-hop-self`
`no neighbor <neighborid> next-hop-self`

Parameter	Description
<code><neighborid></code>	{ <code><ip-address></code> <code><tag></code> }
<code><ip-address></code>	The address of an IPv4 BGP neighbor, in dotted decimal notation A.B.C.D.
<code><tag></code>	Name of an existing peer-group. For information on how to create peer groups, refer to the neighbor peer-group (adding a neighbor) command on page 38.93 , and neighbor remote-as command on page 38.97 . When this parameter is used with a command, the command applies on all peers in the specified group.

Mode Router Configuration

Usage This command allows a BGP router to change the nexthop information that is sent to the iBGP peer. The nexthop information is set to the IP address of the interface used to communicate with the neighbor.

Example

```
awplus# configure terminal
awplus(config)# router bgp 10
awplus(config-router)# neighbor 10.10.0.72 remote-as 100
awplus(config-router)# neighbor 10.10.0.72 next-hop-self
```

neighbor override-capability

Use this command to override a capability negotiation result.

Use the **no** variant of with this command to disable this function

Syntax `neighbor <neighborid> override-capability`

`no neighbor <neighborid> override-capability`

Parameter	Description
<code><neighborid></code>	<code>{<ip-address> <tag>}</code>
	<code><ip-address></code> The address of an IPv4 BGP neighbor, in dotted decimal notation A.B.C.D.
	<code><tag></code> Name of an existing peer-group. For information on how to create peer groups, refer to the neighbor peer-group (adding a neighbor) command on page 38.93 , and neighbor remote-as command on page 38.97 . When this parameter is used with a command, the command applies on all peers in the specified group.

Mode Router Configuration

Example

```
awplus# configure terminal
awplus(config)# router bgp 12
awplus(config-router)# neighbor 10.10.10.10 override-capability
```

neighbor passive

Use this command to configure the local router to be passive with regard to the specified neighbor. This has the effect that the router will not attempt to initiate connections to this neighbor, but will accept incoming connection attempts from the neighbor.

Use the **no** variant of this command to disable this function

Syntax `neighbor <neighborid> passive`
`no neighbor <neighborid> passive`

Parameter	Description
<neighborid>	{<ip-address> <tag>}
<ip-address>	The address of an IPv4 BGP neighbor, in dotted decimal notation A.B.C.D.
<tag>	Name of an existing peer-group. For information on how to create peer groups, refer to the neighbor peer-group (adding a neighbor) command on page 38.93 , and neighbor remote-as command on page 38.97 . When this parameter is used with a command, the command applies on all peers in the specified group.

Mode Router Configuration

Examples

```
awplus# configure terminal
awplus(config)# router bgp 12
awplus(config-router)# neighbor 10.10.10.10 passive

awplus# configure terminal
awplus(config)# router bgp 12
awplus(config-router)# no neighbor 10.10.10.10 passive
```

neighbor password

Use this command to enable MD5 authentication on a TCP connection between BGP neighbors.

Use the **no** variant of this command to disable this function.

Syntax `neighbor {<ip-address>|<peer-group-name>} password <0-7> <password>`
`no neighbor {<ip-address>|<peer-group-name>} password <0-7> <password>`

Parameter	Description
<code><ip-address></code>	<i>A.B.C.D</i> Specifies the address of the BGP neighbor in IPv4 format.
<code><peer-group-name></code>	Name of an existing peer-group. When this parameter is used with a command, the command applies on all peers in the specified group.
<code><0-7></code>	Specify the encryption type. Where 0 is for disabling encryption and 7 is for a proprietary encryption type.
<code><password></code>	An alphanumeric string of characters to be used as password.

Mode Router Configuration

Usage When using the `<peer-group-name>` parameter with this command (to apply this command to all peers in the group), see the related commands [neighbor peer-group \(adding a neighbor\)](#) and [neighbor remote-as](#) for information about how to create peer groups first.

Example This example specifies the encryption type and the password (`manager`) for the neighbor 10.10.10.10:

```
awplus# configure terminal
awplus(config)# router bgp 1
awplus(config-router)# neighbor 10.10.10.10 password 3 manager
```

Related Commands [neighbor peer-group \(adding a neighbor\)](#)
[neighbor remote-as](#)

neighbor peer-group (adding a neighbor)

Use this command to add a neighbor to an existing peer-group.

Use the **no** variant of this command to disable this function.

Syntax `neighbor <ip-address> peer-group <tag>`
`no neighbor <ip-address> peer-group <tag>`

Parameter	Description
<code><ip-address></code>	Specifies the IPv4 address of the BGP neighbor, entered in the format A.B.C.D.
<code><tag></code>	Name of the peer-group.

Mode Router Configuration

Usage Use this command to add Neighbors with the same update policies to a peer group. This facilitates the updates of various policies, such as, distribute and filter lists. The peer-group is then configured easily with any of the neighbor commands. Any changes made to the peer group affect all members.

To create a peer-group use the `neighbor peer-group create` command and then use this command to add neighbors to the group.

Example This example shows a new peer-group `group1` and the adding of a neighbor `10.10.0.63` to the group.

```
awplus# configure terminal
awplus(config)# router bgp 10
awplus(config-router)# neighbor group1 peer-group
awplus(config-router)# neighbor 10.10.0.63 peer-group group1
```

neighbor peer-group (creating a peer-group)

Use this command to create a peer-group.

Use the **no** variant of this command to disable this function

Syntax `neighbor <tag> peer-group`
`no neighbor <tag> peer-group`

Parameter	Description
<tag>	Name of the peer-group.

Mode Router Configuration

Usage Neighbors with the same update policies are grouped into peer groups. This facilitates the updates of various policies, such as, distribute and filter lists. The peer-group is then configured easily with any of the neighbor commands. Any changes made to the peer group affect all members. Use this command to create a peer-group.

Example

```
awplus# configure terminal
awplus(config)# router bgp 10
awplus(config-router)# neighbor group1 peer-group
```

neighbor port

Use this command to specify the TCP port to which packets are sent to on a neighbor.

Syntax `neighbor <neighborid> port <portnum>`
`no neighbor <neighborid> port [<portnum>]`

Parameter	Description
<code><neighborid></code>	{ <code><ip-address></code> <code><tag></code> }
<code><ip-address></code>	The address of an IPv4 BGP neighbor, in dotted decimal notation A.B.C.D.
<code><tag></code>	Name of an existing peer-group. For information on how to create peer groups, refer to the neighbor peer-group (adding a neighbor) command on page 38.93 , and neighbor remote-as command on page 38.97 . When this parameter is used with a command, the command applies on all peers in the specified group.
<code><portnum></code>	<code><0-65535></code> Specifies the TCP port number.

Mode Router Configuration

Example

```
awplus# configure terminal
awplus(config)# router bgp 12
awplus(config-router)# neighbor 10.10.10.10 port 643
```

neighbor prefix-list

Use this command to distribute BGP neighbor information as specified in a prefix list.

Use the **no** variant of this command to remove an entry.

Syntax `neighbor <neighborid> prefix-list <listname> {in|out}`
`no neighbor <neighborid> prefix-list <listname> {in|out}`

Parameter	Description
<code><neighborid></code>	<code>{<ip-address> <tag>}</code>
	<code><ip-address></code> The address of an IPv4 BGP neighbor, in dotted decimal notation A.B.C.D.
	<code><tag></code> Name of an existing peer-group. For information on how to create peer groups, refer to the neighbor peer-group (adding a neighbor) command on page 38.93 , and neighbor remote-as command on page 38.97 . When this parameter is used with a command, the command applies on all peers in the specified group.
<code><listname></code>	The name of an IP prefix list.
<code>in</code>	Specifies that the IP prefix list applies to incoming advertisements.
<code>out</code>	Specifies that the IP prefix list applies to outgoing advertisements.

Mode Router Configuration

Usage Use this command to specify a prefix list for filtering BGP advertisements. Filtering by prefix list matches the prefixes of routes with those listed in the prefix list. If there is a match, the route is used. An empty prefix list permits all prefixes. If a given prefix does not match any entries of a prefix list, the route is denied access.

The router begins the search at the top of the prefix list, with the sequence number 1. Once a match or deny occurs, the router does not need to go through the rest of the prefix list. For efficiency the most common matches or denies are listed at the top.

The **neighbor distribute-list** command is an alternative to the **neighbor prefix-list** command and only one of them can be used for filtering to the same neighbor in any direction.

Example

```
awplus# configure terminal
awplus(config)# ip prefix-list list1 deny 30.0.0.0/24
awplus(config)# router bgp 12
awplus(config-router)# neighbor 10.10.10.10 prefix-list list1
in
```

Related Commands [ip prefix-list](#)

neighbor remote-as

Use this command to configure an internal or external BGP (iBGP or eBGP) peering relationship with another router.

Use the **no** variant of this command to remove a previously configured BGP peering relationship.

Syntax `neighbor <neighborid> remote-as <as-number>`
`no neighbor <neighborid> remote-as <as-number>`

Parameter	Description
<code><neighborid></code>	{ <code><ip-address></code> <code><tag></code> }
<code><ip-address></code>	The address of an IPv4 BGP neighbor, in dotted decimal notation A.B.C.D.
<code><tag></code>	Name of an existing peer-group. For information on how to create peer groups, refer to the neighbor peer-group (adding a neighbor) command on page 38.93 , and neighbor remote-as command on page 38.97 . When this parameter is used with a command, the command applies on all peers in the specified group.
<code><as-number></code>	<code><1-65535></code> Neighbor's Autonomous System (AS) number.

Mode Router Configuration

Usage This command is used to configure iBGP and eBGP peering relationships with other neighbors. A peer-group support of this command is configured only after creating a specific peer-group. Use the **no** variant of this command to remove a previously configured BGP peering relationship.

Examples To configure a BGP peering relationship with another router:

```
awplus# configure terminal
awplus(config)# router bgp 11
awplus(config-router)# neighbor 10.10.0.73 remote-as 345
```

To remove a configured BGP peering relationship from another router:

```
awplus# configure terminal
awplus(config)# router bgp 11
awplus(config-router)# no neighbor 10.10.0.73 remote-as 345
```

neighbor remove-private-AS

Use this command to remove the private Autonomous System (AS) number from outbound updates.

Use the **no** variant of this command to revert to default.

Syntax `neighbor <neighborid> remove-private-AS`
`no neighbor <neighborid> remove-private-AS`

Parameter	Description
<neighborid>	{<ip-address> <tag>}
<ip-address>	The address of an IPv4 BGP neighbor, in dotted decimal notation A.B.C.D.
<tag>	Name of an existing peer-group. For information on how to create peer groups, refer to the neighbor peer-group (adding a neighbor) command on page 38.93 , and neighbor remote-as command on page 38.97 . When this parameter is used with a command, the command applies on all peers in the specified group.

Default Disabled

Mode Router Configuration

Usage The private AS numbers range from <64512-65535>. Private AS numbers are not advertised to the Internet. This command is used with external BGP peers only. The router removes the AS numbers only if the update includes private AS numbers. If the update includes both private and public AS numbers, the system treats it as an error.

Examples

```
awplus# configure terminal
awplus(config)# router bgp 10
awplus(config-router)# neighbor 10.10.0.63 remove-private-AS

awplus# configure terminal
awplus(config)# router bgp 10
awplus(config-router)# no neighbor 10.10.0.63 remove-private-AS
```

neighbor restart-time

Use this command to set a different restart-time other than the global restart-time configured using the `bgp graceful-restart` command.

Use the `no` variant of this command to restore the device to its default state.

Syntax `neighbor <neighborid> restart-time <delay-value>`
`no neighbor <neighborid> restart-time <delay-value>`

Parameter	Description
<code><neighborid></code>	{ <code><ip-address></code> <code><tag></code> }
<code><ip-address></code>	The address of an IPv4 BGP neighbor, in dotted decimal notation A.B.C.D.
<code><tag></code>	Name of an existing peer-group. For information on how to create peer groups, refer to the neighbor peer-group (adding a neighbor) command on page 38.93 , and neighbor remote-as command on page 38.97 . When this parameter is used with a command, the command applies on all peers in the specified group.
<code><delay-value></code>	<code><1-3600></code> Delay value in seconds.

Mode Router Configuration

Usage This command takes precedence over the restart-time value specified using the `bgp graceful-restart` command.

The restart-time value is the maximum time that a graceful-restart neighbor waits to come back up after a restart. The default value is 120 seconds.

Make sure that the restart time specified using this command does not exceed the stalepath-time specified in the Router Configuration mode.

Examples

```
awplus# configure terminal
awplus(config)# router bgp 10
awplus(config-router)# neighbor 3.3.3.3 restart-time 45

awplus# configure terminal
awplus(config)# router bgp 10
awplus(config-router)# no neighbor 3.3.3.3 restart-time 45
```

Related Commands [bgp graceful-restart](#)

neighbor route-map

Use this command to apply a route map to incoming or outgoing routes.

Use the **no** variant of this command to remove a route map.

Syntax `neighbor <neighborid> route-map <mapname> {in|out}`
`no neighbor <neighborid> route-map <mapname> {in|out}`

Parameter	Description
<neighborid>	{<ip-address> <tag>}
	<ip-address> The address of an IPv4 BGP neighbor, in dotted decimal notation A.B.C.D.
	<tag> Name of an existing peer-group. For information on how to create peer groups, refer to the neighbor peer-group (adding a neighbor) command on page 38.93 , and neighbor remote-as command on page 38.97 . When this parameter is used with a command, the command applies on all peers in the specified group.
<mapname>	Specifies name of the route-map.
in	Specifies that the access list applies to incoming advertisements
out	Specifies that the access list applies to outgoing advertisements.

Mode Router Configuration

Usage Use **neighbor route-map** command to filter updates and modify attributes. A route map is applied to inbound or outbound updates. Only the routes that pass the route map are sent or accepted in updates.

Example The following example shows the configuration of the route-map name **rmap2** and then the use of this map name in the **neighbor route-map** command.

```
awplus# configure terminal
awplus(config)# route-map rmap2 permit 6
awplus(config-route-map)# match origin incomplete
awplus(config-route-map)# set metric 100
awplus(config-route-map)# exit
awplus(config)# router bgp 12
awplus(config-router)# neighbor 10.10.10.10 route-map rmap2
in
```

Related Commands [route-map](#)

neighbor route-reflector-client

Use this command to configure the router as a BGP route reflector and configure the specified neighbor as its client.

Use the **no** variant of this command to indicate that the neighbor is not a client.

Syntax `neighbor <neighborid> route-reflector-client`
`no neighbor <neighborid> route-reflector-client`

Parameter	Description
<neighborid>	{<ip-address> <tag>}
<ip-address>	The address of an IPv4 BGP neighbor, in dotted decimal notation A.B.C.D.
<tag>	Name of an existing peer-group. For information on how to create peer groups, refer to the neighbor peer-group (adding a neighbor) command on page 38.93 , and neighbor remote-as command on page 38.97 . When this parameter is used with a command, the command applies on all peers in the specified group.

Mode Router Configuration

Usage Route reflectors are a solution for the explosion of iBGP peering within an autonomous system. By route reflection the number of iBGP peers within an AS is reduced. Use the **neighbor route-reflector-client** command to configure the local router as the route reflector and specify neighbors as its client.

An AS can have more than one route reflector. One route reflector treats the other route reflector as another iBGP speaker.

In the following configuration, Router1 is the route reflector for clients 3.3.3.3 and 2.2.2.2; it also has a non-client peer 6.6.6.6:

```
Router1#
router bgp 200
neighbor 3.3.3.3 remote-as 200
neighbor 3.3.3.3 route-reflector-client
neighbor 2.2.2.2 remote-as 200
neighbor 2.2.2.2 route-reflector-client
neighbor 6.6.6.6 remote-as 200
```

Examples

```
awplus# configure terminal
awplus(config)# router bgp 10
awplus(config-router)# neighbor 10.10.0.72 route-reflector-client
```

```
awplus# configure terminal
awplus(config)# router bgp 10
awplus(config-router)# no neighbor 10.10.0.72 route-reflector-client
```

neighbor route-server-client

Use this command to specify the peer as route server client.

Use the **no** variant of this command to disable this function

Syntax `neighbor <neighborid> route-server-client`
`no neighbor <neighborid> route-server-client`

Parameter	Description
<neighborid>	{<ip-address> <tag>}
<ip-address>	The address of an IPv4 BGP neighbor, in dotted decimal notation A.B.C.D.
<tag>	Name of an existing peer-group. For information on how to create peer groups, refer to the neighbor peer-group (adding a neighbor) command on page 38.93 , and neighbor remote-as command on page 38.97 . When this parameter is used with a command, the command applies on all peers in the specified group.

Mode Router Configuration

Examples

```
awplus# configure terminal
awplus(config)# router bgp 10
awplus(config-router)# neighbor 10.10.0.72 route-server-client

awplus# configure terminal
awplus(config)# router bgp 10
awplus(config-router)# no neighbor 10.10.0.72 route-server-client
```

neighbor send-community

Use this command to specify that a community attribute should be sent to a BGP neighbor.

Use the **no** variant of this command to remove the entry.

Use the **extended** and **no** parameters to remove extended communities. Specifying no other parameter with **no** removes standard communities only.

Syntax `neighbor <neighborid> send-community {both|extended|standard}`
`no neighbor <neighborid> send-community {both|extended|standard}`

Parameter	Description
<code><neighborid></code>	<code>{<ip-address> <tag>}</code>
	<code><ip-address></code> The address of an IPv4 BGP neighbor, in dotted decimal notation A.B.C.D.
	<code><tag></code> Name of an existing peer-group. For information on how to create peer groups, refer to the neighbor peer-group (adding a neighbor) command on page 38.93 , and neighbor remote-as command on page 38.97 . When this parameter is used with a command, the command applies on all peers in the specified group.
<code>both</code>	Sends Standard and Extended Community attributes
<code>extended</code>	Sends Extended Community attributes
<code>standard</code>	Sends Standard Community attributes

Default Both **standard** and **extended** community attributes are sent to a neighbor.

Mode Router Configuration

Usage This command is used to specify a community attribute to be sent to a neighbor. The community attribute groups destinations in a certain community and applies routing decisions according to those communities. On receiving community attributes the router reannounces them to the neighbor. Only when the **no** parameter is used with this command the community attributes are not reannounced to the neighbor.

By default, both **standard** and **extended** community attributes are sent to a neighbor. To explicitly send only the **standard** or **extended** community attribute, run the [bgp config-type command on page 38.19](#) with the **standard** parameter, before running this command.

Example

```
awplus# configure terminal
awplus(config)# bgp config-type standard
awplus(config)# router bgp 10
awplus(config-router)# neighbor 10.10.0.72 send-community
extended
```

Related Commands [bgp config-type](#)

neighbor shutdown

Use this command to disable a peering relationship with a neighbor.

Use the **no** variant of this command to re-enable the neighbor.

Syntax `neighbor <neighborid> shutdown`
`no neighbor <neighborid> shutdown`

Parameter	Description
<code><neighborid></code>	<code>{<ip-address> <tag>}</code>
<code><ip-address></code>	The address of an IPv4 BGP neighbor, in dotted decimal notation A.B.C.D.
<code><tag></code>	Name of an existing peer-group. For information on how to create peer groups, refer to the neighbor peer-group (adding a neighbor) command on page 38.93 , and neighbor remote-as command on page 38.97 . When this parameter is used with a command, the command applies on all peers in the specified group.

Mode Router Configuration

Usage This command shuts down any active session for the specified neighbor and clears all related routing data.

Examples

```
awplus# configure terminal
awplus(config)# router bgp 10
awplus(config-router)# neighbor 10.10.0.72 shutdown
```

```
awplus# configure terminal
awplus(config)# router bgp 10
awplus(config-router)# no neighbor 10.10.0.72 shutdown
```

neighbor soft-reconfiguration inbound

Use this command to configure the switch to start storing all updates from the neighbor, without any consideration of any inward route filtering policy that might be applied to the connection with this neighbor. This is so that the full set of the neighbor's updates are available locally to be used in a soft-reconfiguration event.

Use the **no** variant of this command to disable this function.

Syntax `neighbor <neighborid> soft-reconfiguration inbound`
`no neighbor <neighborid> soft-reconfiguration inbound`

Parameter	Description
<code><neighborid></code>	{ <code><ip-address></code> <code><tag></code> }
<code><ip-address></code>	The address of an IPv4 BGP neighbor, in dotted decimal notation A.B.C.D.
<code><tag></code>	Name of an existing peer-group. For information on how to create peer groups, refer to the neighbor peer-group (adding a neighbor) command on page 38.93 , and neighbor remote-as command on page 38.97 . When this parameter is used with a command, the command applies on all peers in the specified group.

Mode Router Configuration

Usage Use this command to store updates for inbound soft reconfiguration. Soft-reconfiguration may be used in lieu of BGP route refresh capability. Using this command enables local storage of all the received routes and their attributes. This requires additional memory. When a soft reset (inbound) is done on this neighbor, the locally stored routes are re-processed according to the inbound policy. The BGP neighbor connection is not affected.

Examples

```
awplus# configure terminal
awplus(config)# router bgp 12
awplus(config-router)# neighbor 10.10.10.10 soft-
reconfiguration inbound

awplus# configure terminal
awplus(config)# router bgp 12
awplus(config-router)# no neighbor 10.10.10.10 soft-
reconfiguration inbound
```

neighbor strict-capability-match

Use this command to close the BGP connection if the capabilities being advertised by the switch do not exactly match the capabilities being advertised by the neighbor.

Use the **no** variant of this command to disable this function

Syntax `neighbor <neighborid> strict-capability-match`
`no neighbor <neighborid> strict-capability-match`

Parameter	Description
<code><neighborid></code>	<code>{<ip-address> <tag>}</code>
<code><ip-address></code>	The address of an IPv4 BGP neighbor, in dotted decimal notation A.B.C.D.
<code><tag></code>	Name of an existing peer-group. For information on how to create peer groups, refer to the neighbor peer-group (adding a neighbor) command on page 38.93 , and neighbor remote-as command on page 38.97 . When this parameter is used with a command, the command applies on all peers in the specified group.

Mode Router Configuration

Example

```
awplus# configure terminal
awplus(config)# router bgp 12
awplus(config-router)# neighbor 10.10.10.10 strict-
capability-match
```

neighbor timers

Use this command to set the timers for a specific BGP neighbor.

Use the **no** variant of this command to clear the timers for a specific BGP neighbor

Syntax `neighbor <neighborid> timers {<keepalive> <holdtime> | <connect>}`
`no neighbor <neighborid> timers [<connect>]`

Parameter	Description
<neighborid>	{<ip-address> <tag>}
	<ip-address> The address of an IPv4 BGP neighbor, in dotted decimal notation A.B.C.D.
	<tag> Name of an existing peer-group. For information on how to create peer groups, refer to the neighbor peer-group (adding a neighbor) command on page 38.93 , and neighbor remote-as command on page 38.97 . When this parameter is used with a command, the command applies on all peers in the specified group.
<keepalive>	<0-65535> Frequency (in seconds) at which a router sends keepalive messages to its neighbor. The default is 60 seconds
<holdtime>	<0-65535> Interval (in seconds) after which, on not receiving a keepalive message, the router declares a neighbor dead. The default is 180 seconds.
<connect>	<1-65535> Specifies the connect timer in seconds.

Mode Router Configuration

Usage Keepalive messages are sent by a router to inform another router that the BGP connection between the two is still active. The keepalive interval is the period of time between each keepalive message sent by the router. The holdtime interval is the time the router waits to receive a keepalive message and if it does not receive a message for this period it declares the neighbor dead.

Example

```
awplus# configure terminal
awplus(config)# router bgp 12
awplus(config-router)# neighbor 10.10.10.10 timers 60 120
awplus(config-router)# neighbor 10.10.10.10 timers connect 10
```

neighbor transparent-as

Use this command to specify not to append your AS path number even if the peer is an eBGP peer.

Syntax `neighbor <neighborid> transparent-as`

Parameter	Description
<neighborid>	{<ip-address> <tag>}
<ip-address>	The address of an IPv4 BGP neighbor, in dotted decimal notation A.B.C.D.
<tag>	Name of an existing peer-group. For information on how to create peer groups, refer to the neighbor peer-group (adding a neighbor) command on page 38.93 , and neighbor remote-as command on page 38.97 . When this parameter is used with a command, the command applies on all peers in the specified group.

Mode Router Configuration

Example

```
awplus# configure terminal
awplus(config)# router bgp 12
awplus(config-router)# neighbor 10.10.10.10 transparent-as
```

neighbor transparent-nextthop

Use this command to keep the nextthop value of the route even if the peer is an eBGP peer.

Syntax `neighbor <neighborid> transparent-nextthop`

Parameter	Description
<neighborid>	{<ip-address> <tag>}
<ip-address>	The address of an IPv4 BGP neighbor, in dotted decimal notation A.B.C.D.
<tag>	Name of an existing peer-group. For information on how to create peer groups, refer to the neighbor peer-group (adding a neighbor) command on page 38.93 , and neighbor remote-as command on page 38.97 . When this parameter is used with a command, the command applies on all peers in the specified group.

Mode Router Configuration

Example

```
awplus# configure terminal
awplus(config)# router bgp 12
awplus(config-router)# neighbor 10.10.10.10 transparent-nextthop
```

neighbor unsuppress-map

Use this command to selectively leak more-specific routes to a particular neighbor.

Use the **no** variant of this command to remove selectively leaked specific routes to a particular neighbor as specified previously with the **neighbor unsuppress-map** command.

Syntax `neighbor <neighborid> unsuppress-map <route-map-name>`
`no neighbor <neighborid> unsuppress-map <route-map-name>`

Parameter	Description
<code><neighborid></code>	{ <code><ip-address></code> <code><tag></code> }
<code><ip-address></code>	The address of an IPv4 BGP neighbor, in dotted decimal notation A.B.C.D.
<code><tag></code>	Name of an existing peer-group. For information on how to create peer groups, refer to the neighbor peer-group (adding a neighbor) command on page 38.93 , and neighbor remote-as command on page 38.97 . When this parameter is used with a command, the command applies on all peers in the specified group.
<code><route-map-name></code>	The name of the route-map used to select routes to be unsuppressed.

Mode Router Configuration and Address Family [`ipv4 unicast` | `ipv4 multicast`] mode

Usage When the **aggregate-address** command is used with the **summary-only** option, the more-specific routes of the aggregate are suppressed to all neighbors. Use the **unsuppress-map** command to selectively leak more-specific routes to a particular neighbor.

Examples

```
awplus# configure terminal
awplus(config)# router bgp 10
awplus(config-router)# neighbor 10.10.0.73 unsuppress-map
mymap

awplus# configure terminal
awplus(config)# router bgp 10
awplus(config-router)# address-family ipv4 unicast
awplus(config-router-af)# neighbor 10.10.0.70 unsuppress-map
mymap
```

neighbor update-source

Use this command to specify that the source IP address of BGP packets sent to the neighbor to be the IP address that is configured on the specified interface.

Use the **no** variant of this command to remove the IP address from the interface as the source IP address of BGP packets sent to the neighbor.

Syntax `neighbor <neighborid> update-source <interface>`
`no neighbor <neighborid> update-source`

Parameter	Description
<code><neighborid></code>	{ <code><ip-address></code> <code><tag></code> }
<code><ip-address></code>	The address of an IPv4 BGP neighbor, in dotted decimal notation A.B.C.D.
<code><tag></code>	Name of an existing peer-group. For information on how to create peer groups, refer to the neighbor peer-group (adding a neighbor) command on page 38.93 , and neighbor remote-as command on page 38.97 . When this parameter is used with a command, the command applies on all peers in the specified group.
<code><interface></code>	Specifies the loopback interface.

Mode Router Configuration

Usage Use this command in conjunction with any specified interface on the router. The loopback interface is the interface that is most commonly used with this command. The use of loopback interface eliminates a dependency and BGP does not have to rely on the availability of a particular interface for making BGP peer relationships..

Example

```
awplus# configure terminal
awplus(config)# router bgp 10
awplus(config-router)# neighbor 10.10.0.72 update-source myif
```

neighbor version

Use this command to configure the switch to accept only a particular BGP version.

Use the **no** variant of this command to use the default BGP version (version 4).

Syntax `neighbor <neighborid> version <version>`
`no neighbor <neighborid> version`

Parameter	Description
<code><neighborid></code>	<code>{<ip-address> <tag>}</code>
	<code><ip-address></code> The address of an IPv4 BGP neighbor, in dotted decimal notation A.B.C.D.
	<code><tag></code> Name of an existing peer-group. For information on how to create peer groups, refer to the neighbor peer-group (adding a neighbor) command on page 38.93 , and neighbor remote-as command on page 38.97 . When this parameter is used with a command, the command applies on all peers in the specified group.
<code><version></code>	<code>{4}</code> Specifies the BGP version number.

Mode Router Configuration

Usage By default, the system uses BGP version 4 and on request dynamically negotiates down to version 2. Using this command disables the router's version-negotiation capability and forces the router to use only a specified version with the neighbor.

Example

```
awplus# configure terminal
awplus(config)# router bgp 12
awplus(config-router)# neighbor 10.10.10.10 version 4
```

neighbor weight

Use this command to set default weights for routes from this neighbor.

Use the **no** variant of this command to remove a weight assignment.

Syntax `neighbor <neighborid> weight <weight>`
`no neighbor <neighborid> weight [<weight>]`

Parameter	Description
<code><neighborid></code>	{ <code><ip-address></code> <code><tag></code> }
<code><ip-address></code>	The address of an IPv4 BGP neighbor, in dotted decimal notation A.B.C.D.
<code><tag></code>	Name of an existing peer-group. For information on how to create peer groups, refer to the neighbor peer-group (adding a neighbor) command on page 38.93 , and neighbor remote-as command on page 38.97 . When this parameter is used with a command, the command applies on all peers in the specified group.
<code><weight></code>	<code><0-65535></code> Specifies the weight this command assigns to the route.

Mode Router Configuration

Usage Use this command to specify a weight value to all routes learned from a neighbor. The route with the highest weight gets preference when there are other routes on the network.

Unlike the local-preference attribute, the weight attribute is relevant only to the local router.

The weights assigned using the **set weight** command overrides the weights assigned using this command.

Example

```
awplus# configure terminal
awplus(config)# router bgp 12
awplus(config-router)# neighbor 10.10.10.10 weight 60
```

network (BGP)

Use this command to specify particular routes to be redistributed into the BGP routing process. A unicast network address without a mask is accepted if it falls into the natural boundary of its class. A class-boundary mask is derived if the address matches its natural class-boundary.

Use the **no** variant of this command to remove a network route entry.

Syntax `network <ip-network-prefix> [route-map <route-map-name>]`
`no network <ip-network-prefix> [route-map <route-map-name>]`

Parameter	Description
<code><ip-network-prefix></code>	IP network prefix entered in the format A.B.C.D, e.g. 35.0.0.0
<code><route-map-name></code>	Name of the route map

Mode Router Configuration and Address Family [`ipv4 unicast`|`ipv4 multicast`] mode

Usage The route configured by this command will not be advertised by BGP unless it appears in the IP routing table. It does not matter how it arrange in the IP routing table. The route can arrive in the IP routing table by a static route, or the route can be learnt from OSPF or RIP routing.

If you configure a route-map, then that route-map will be used in filtering the network, or the route-map will be used to modify the attributes that are advertised with the route.

Example The following example illustrates a Class-A address configured as a network route. The natural Class-A network prefix mask length of 8 will be internally derived, that is, 2.0.0.0/8.

```
awplus(config)# router bgp 1
awplus(config-router)# network 2.0.0.0
awplus(config-router)# exit
awplus(config)# exit
awplus# show run
```

```
router bgp 1
no synchronization
network 1.0.0.0
```

The following example illustrates a network address which does not fall into its natural class boundary, and hence, is perceived as a host route, that is, 1.2.3.0/32.

```
awplus(config)# router bgp 1
awplus(config-router)# network 1.2.3.0
awplus(config-router)# exit
awplus(config)# exit
awplus# show run
```

```
router bgp 1
  no synchronization
  network 1.2.3.0 mask 255.255.255.255
```

network synchronization

Use this command to ensure the exact same static network prefix, specified through any of the **network <prefix>** commands, is local or has IGP reachability (in the NSM RIB) before being introduced into the BGP RIB.

Use the **no** variant of this command to disable this function.

Syntax `network synchronization`

`no network synchronization`

Default Network synchronization is disabled by default.

Mode Router Configuration and Address Family [ipv4 unicast] mode

Examples The following example enables IGP synchronization of BGP static network routes in the Router Configuration mode.

```
awplus# configure terminal
awplus(config)# router bgp 11
awplus(config-router)# network synchronization
```

The following example enables IGP synchronization of BGP static network routes in the IPv4-Unicast address family.

```
awplus# configure terminal
awplus(config)# router bgp 11
awplus(config-router)# address-family ipv4 unicast
awplus(config-router-af)# network synchronization
```

redistribute route-map

Use this command to inject routes from one routing process into another.

Use the **no** variant of this command to disable this function.

Syntax `redistribute {ospf|rip|connected|static} [route-map <route-map-entry-pointer>]`
`no redistribute {ospf|rip|connected|static} [route-map <route-map-entry-pointer>]`

Parameter	Description
<code>connected</code>	Specifies the redistribution of connected routes.
<code>ospf</code>	Specifies the redistribution of OSPF information.
<code>rip</code>	Specifies the redistribution of RIP.
<code>static</code>	Specifies the redistribution of Static routes.
<code>route-map</code>	Route map reference
<code><route-map-entry-pointer></code>	Pointer to route-map entries.

Mode Router Configuration

Usage Redistribution is used by routing protocols to advertise routes that are learned by some other means, such as by another routing protocol or by static routes. Since all internal routes are dumped into BGP, careful filtering is applied to make sure that only routes to be advertised reach the internet, not everything. This command allows redistribution by injecting prefixes from one routing protocol into another routing protocol.

Example The following example shows the configuration of the route-map name **rmap1** and then the use of this map name in the **redistribute route-map** command.

```
awplus# configure terminal
awplus(config)# route-map rmap1 permit 1
awplus(config-route-map)# match origin incomplete
awplus(config-route-map)# set metric 100
awplus(config-route-map)# exit
awplus(config)# router bgp 12
awplus(config-router)# redistribute ospf route-map rmap1
```

restart bgp graceful

Use this command to force the switch to perform a graceful BGP restart.

Syntax `restart bgp graceful`

Mode Privileged Exec

Usage This command stops the whole BGP process and makes AlliedWare Plus™ retain the BGP routes and mark them as stale. Receiving BGP speakers, retain and mark as stale all BGP routes received from the restarting speaker for all the address families received in the Graceful Restart Capability exchange.

When a **restart bgp graceful** command is issued, the BGP configuration is reloaded from the last saved configuration. Ensure you first issue a **copy running-config startup-config**.

Example

```
awplus# restart bgp graceful
```

Related Commands [neighbor capability graceful-restart](#)

router bgp

Use this command to configure a BGP routing process.

Use the **no** variant of this command to disable a routing process.

Syntax `router bgp <asn>`
`no router bgp <asn>`

Parameter	Description
<asn>	<1-65525> Specifies the Autonomous System (AS) number.

Mode Global Configuration

Usage The `router bgp` command enables a BGP routing process so you can set up a route server.

```
router bgp 1
  neighbor 10.0.0.1 remote-as 2
  neighbor 10.0.0.2 remote-as 3
  !
router bgp 2
  neighbor 10.0.0.3 remote-as 4
  neighbor 10.0.0.4 remote-as 5
```

Example

```
awplus# configure terminal
awplus(config)# router bgp 12
awplus(config-router)#
```

Related Commands [router bgp view](#)

router bgp view

Use this command to create a named BGP view. BGP views can have the same or different Autonomous System (AS) number. BGP view is only for exchanging BGP routing information.

Use the **no** variant of this command to disable a named BGP view.

Syntax `router bgp <asn> view <view-name>`
`no router bgp <asn> view <view-name>`

Parameter	Description
<asn>	<1-65525> Specifies the Autonomous System (AS) number.
<view-name>	Specifies BGP view name.

Mode Global Configuration

Usage Specify **bgp multiple-instance** before applying **router bgp view** so you can setup a route server:

```
router bgp 1 view 1
  neighbor 10.0.0.1 remote-as 2
  neighbor 10.0.0.2 remote-as 3
!
router bgp 2 view 2
  neighbor 10.0.0.3 remote-as 4
  neighbor 10.0.0.4 remote-as 5
```

If you have enabled bgp with the **router bgp** command you must disable bgp with the **no router bgp** command before you can specify **bgp multiple-instance**.

Example

```
awplus# configure terminal
awplus(config)# bgp multiple-instance
awplus(config)# router bgp 12 view bgp12
awplus(config-router)#
```

Related Commands `bgp multiple-instance`
`clear bgp view`
`clear ip bgp view`
`router bgp`
`show ip bgp view`
`show ip bgp view summary`
`show ip bgp view neighbors`

show bgp nexthop-tracking

Use this command to display BGP nexthop-tracking status.

Syntax `show bgp nexthop-tracking`

Mode User Exec and Privileged Exec

Example To display BGP nexthop-tracking status, use the command:

```
awplus# show bgp nexthop-tracking
```

Related Commands [bgp nexthop-trigger-count](#)
[show bgp nexthop-tree-details](#)

show bgp nexthop-tree-details

Use this command to display BGP nexthop-tree-details.

Syntax `show bgp nexthop-tree-details`

Mode Privileged Exec

Example To display BGP nexthop-tree-details, use the command:

```
awplus# show bgp nexthop-tree-details
```

Related Commands [show bgp nexthop-tracking](#)

show bgp memory maxallocation

This command displays the maximum percentage of total memory that is allocated to BGP processes.

For information on output options, see [“Controlling “show” Command Output” on page 1.35.](#)

Syntax `show bgp memory maxallocation`

Mode Privileged Exec

Example To display the maximum amount of memory allocated for BGP processes, use the command:

```
awplus# show bgp memory maxallocation
```

Output Figure 38-1: Example output from the `show bgp memory maxallocation` command

```
BGP maximum RAM allocation is 100%
```

show debugging bgp

Use this command to display the BGP debugging option set.

For information on output options, see [“Controlling “show” Command Output” on page 1.35.](#)

Syntax `show debugging bgp`

Mode Privileged Exec

Example

```
awplus# show debugging bgp
```

Output [Figure 38-2: Example output from the `show debugging bgp` command](#)

```
BGP debugging status:
  BGP debugging is on
  BGP events debugging is on
  BGP updates debugging is on
  BGP fsm debugging is on
```

Related Commands [debug bgp](#)

show ip bgp

Use this command to display BGP network information.

For information on output options, see “Controlling “show” Command Output” on page 1.35.

Syntax `show ip bgp [<ipaddr> | <ipaddr/m>]`
`show ip bgp {<prefix> [<ipaddr>]}`

Parameter	Description
<ipaddr> <ipaddr/m>	Specifies the IPv4 address and optional prefix mask length.
<prefix>	{multicast unicast}
unicast	Specifies a IPv4 unicast address family. This is the default option. Configures parameters relating to the BGP exchange of routes to unicast destinations.
multicast	Specifies a IPv4 multicast address family. Configures parameters relating to the BGP exchange of routes to source addresses of multicast streams.

Mode User Exec and Privileged Exec

Default Unicast is the default IPv4 address family.

Example

```
awplus# show ip bgp 10.10.1.34/24
```

Output Figure 38-3: Example output from the `show ip bgp` command

```
BGP table version is 7, local router ID is 80.80.80.80
Status codes: s suppressed, d damped, h history, * valid, > best,
i - internal, S Stale
Origin codes: i - IGP, e - EGP, ? - incomplete

   Network          Next Hop          Metric LocPrf Weight Path
S>i10.70.0.0/24     192.10.23.67      0      100    0 ?
S>i30.30.30.30/32   192.10.23.67      0      100    0 ?
S>i63.63.63.1/32    192.10.23.67      0      100    0 ?
S>i67.67.67.67/32   192.10.23.67      0      100    0 ?
S>i172.22.10.0/24   192.10.23.67      0      100    0 ?
S>i192.10.21.0      192.10.23.67      0      100    0 ?
S>i192.10.23.0      192.10.23.67      0      100    0 ?

Total number of prefixes 7
```

show ip bgp attribute-info

Use this command to show internal attribute hash information.

For information on output options, see [“Controlling “show” Command Output” on page 1.35.](#)

Syntax `show ip bgp attribute-info`

Mode User Exec and Privileged Exec

Example

```
awplus# show ip bgp attribute-info
```

Output Figure 38-4: Example output from the `show ip bgp attribute-info` command

```
attr[1] nexthop 0.0.0.0
attr[1] nexthop 10.10.10.10
attr[1] nexthop 10.10.10.50
```

show ip bgp cidr-only

Use this command to display routes with non-natural network masks.

For information on output options, see [“Controlling “show” Command Output”](#) on page 1.35.

Syntax `show ip bgp cidr-only`
`show ip bgp {multicast|unicast} cidr-only`

Parameter	Description
unicast	Specifies a IPv4 unicast address family. This is the default option. Configures parameters relating to the BGP exchange of routes to unicast destinations.
multicast	Specifies a IPv4 multicast address family. Configures parameters relating to the BGP exchange of routes to source addresses of multicast streams.

Mode User Exec and Privileged Exec

Example

```
awplus# show ip bgp cidr-only
```

Output Figure 38-5: Example output from the `show ip bgp cidr-only` command

```
BGP table version is 0, local router ID is 10.10.10.50
Status codes: s suppressed, d damped, h history, p stale, *
valid, > best, i - internal
Origin codes: i - IGP, e - EGP, ? - incomplete
   Network          Next Hop          Metric LocPrf Weight Path
*> 3.3.3.0/24       10.10.10.10          0 11 i
*> 6.6.6.0/24       0.0.0.0              32768 i
Total number of prefixes 2
```

show ip bgp community

Use this command to display routes matching the communities.

For information on output options, see [“Controlling “show” Command Output” on page 1.35.](#)

You may use any combination and repetition of parameters listed in the `<type>` placeholder.

Syntax `show ip bgp community [<type>] [exact-match]`

Parameter	Description
<code><type></code>	{ [AA:NN] [local-AS] [no-advertise] [no-export] }
<code>AA:NN</code>	Specifies the Autonomous System (AS) community number, in AA:NN format.
<code>local-AS</code>	Do not send outside local Autonomous Systems (well-known community).
<code>no-advertise</code>	Do not advertise to any peer (well-known community).
<code>no-export</code>	Do not export to next AS (well-known community).
<code>exact-match</code>	Specifies that the exact match of the communities is displayed. This optional parameter cannot be repeated.

Mode User Exec and Privileged Exec

Examples

```
awplus# show ip bgp community 64497:64499 exact-match
awplus# show ip bgp community 64497:64499 64500:64501 exact-match
awplus# show ip bgp community 64497:64499 64500:64501 no-advertise 64510:64511
awplus# show ip bgp community no-advertise no-advertise no-advertise exact-match
awplus# show ip bgp community no-export 64510:64511 no-advertise local-AS no-export
awplus# show ip bgp community no-export 64510:64511 no-advertise 64497:64499 64500:64501 no-export
awplus# show ip bgp community no-export 64497:64499 no-advertise local-AS no-export
```

Note that the AS numbers shown are for exemplification only.

Related Commands [set community](#)

show ip bgp community-info

Use this command to list all BGP community information.

For information on output options, see “Controlling “show” Command Output” on page 1.35.

Syntax `show ip bgp community-info`

Mode User Exec and Privileged Exec

Example

```
awplus# show ip bgp community-info
```

show ip bgp community-list

Use this command to display routes that match the community-list.

For information on output options, see “Controlling “show” Command Output” on page 1.35.

Syntax `show ip bgp community-list <listname> [exact-match]`

Parameter	Description
<listname>	Specifies the community list name.
exact-match	Displays only routes that have exactly the same specified communities.

Mode User Exec and Privileged Exec

Example

```
awplus# show ip bgp community-list mylist exact-match
```

show ip bgp dampening

Use this command to display detailed information about dampening.

For information on output options, see [“Controlling “show” Command Output” on page 1.35.](#)

Syntax `show ip bgp dampening {dampened-paths|flap-statistics|parameters}`

`show ip bgp {multicast|unicast} dampening {dampened-paths|flap-statistics|parameters}`

Parameter	Description
dampened-paths	Display paths suppressed due to dampening.
flap-statistics	Display flap statistics of routes.
parameters	Display details of configured dampening parameters.
unicast	Specifies a IPv4 unicast address family. This is the default option. Configures parameters relating to the BGP exchange of routes to unicast destinations.
multicast	Specifies a IPv4 multicast address family. Configures parameters relating to the BGP exchange of routes to source addresses of multicast streams.

Mode User Exec and Privileged Exec

Usage Enable BGP dampening to maintain dampened-path information in memory.

Example

```
awplus# show ip bgp dampening dampened-paths
```

Output Figure 38-6: Example output from the `show ip bgp dampening parameters` command

```
dampening 15 750 2000 60 15
Reachability Half-Life time      : 15 min
Reuse penalty                    : 750
Suppress penalty                 : 2000
Max suppress time                : 60 min
Un-reachability Half-Life time   : 15 min
Max penalty (ceil)               : 11999
Min penalty (floor)              : 375
```

The following sample output is showing that the internal route (i), has flapped 3 times and is now categorized as history (h).

Figure 38-7: Example output from the `show ip bgp dampening flap-statistics` command

```
awplus# show ip bgp dampening flap-statistics
BGP table version is 1, local router ID is 30.30.30.77
Status codes: s suppressed, d damped, h history, * valid, > best, i - internal, S
Stale
Origin codes: i - IGP, e - EGP, ? - incomplete
  Network          From                Flaps  Duration  Reuse    Path
  hi1.1.1.0/24     10.100.0.62         3     00:01:20      i
```

The following sample output is showing a dampened route in the 1.1.1.0/24 network.

Figure 38-8: Example output from the `show ip bgp dampening dampened-path` command

```
awplus# show ip bgp dampening dampened-paths
BGP table version is 1, local router ID is 30.30.30.77
Status codes: s suppressed, d damped, h history, * valid, > best, i - internal, S
Stale
Origin codes: i - IGP, e - EGP, ? - incomplete
  Network          From                Reuse    Path
  di 1.1.1.0/24    10.100.0.62         00:35:10  i
Total number of prefixes 1
```

show ip bgp filter-list

Use this command to display routes conforming to the filter-list.

For information on output options, see [“Controlling “show” Command Output” on page 1.35.](#)

Syntax `show ip bgp filter-list <listname>`
`show ip bgp {multicast|unicast} filter-list <listname>`

Parameter	Description
<code><listname></code>	Specifies the regular-expression access list name.
<code>unicast</code>	Specifies a IPv4 unicast address family. This is the default option. Configures parameters relating to the BGP exchange of routes to unicast destinations.
<code>multicast</code>	Specifies a IPv4 multicast address family. Configures parameters relating to the BGP exchange of routes to source addresses of multicast streams.

Mode User Exec and Privileged Exec

Example

```
awplus# show ip bgp filter-list mylist
awplus# show ip bgp unicast filter-list atl
```

show ip bgp inconsistent-as

Use this command to display routes with inconsistent AS Paths.

For information on output options, see [“Controlling “show” Command Output” on page 1.35.](#)

Syntax `show ip bgp inconsistent-as`
`show ip bgp {multicast|unicast} inconsistent-as`

Parameter	Description
<code>unicast</code>	Specifies a IPv4 unicast address family. This is the default option. Configures parameters relating to the BGP exchange of routes to unicast destinations.
<code>multicast</code>	Specifies a IPv4 multicast address family. Configures parameters relating to the BGP exchange of routes to source addresses of multicast streams.

Mode User Exec and Privileged Exec

Example

```
awplus# show ip bgp inconsistent-as
awplus# show ip bgp ipv4 unicast inconsistent-as
```

show ip bgp longer-prefixes

Use this command to display the route of the local BGP routing table for a specific prefix with a specific mask or for any prefix having a longer mask than the one specified.

For information on output options, see [“Controlling “show” Command Output” on page 1.35.](#)

Syntax `show ip bgp <ip-address/m> longer-prefixes`
`show ip bgp {multicast|unicast} <ip-address/m> longer-prefixes`

Parameter	Description
unicast	Specifies a IPv4 unicast address family. This is the default option. Configures parameters relating to the BGP exchange of routes to unicast destinations.
multicast	Specifies a IPv4 multicast address family. Configures parameters relating to the BGP exchange of routes to source addresses of multicast streams.
<ip-address/m>	Neighbor's IP address and subnet mask, entered in the form A.B.C.D/M. Where M is the subnet mask length.

Mode User Exec and Privileged Exec

Example

```
awplus# show ip bgp 10.10.0.10/24 longer-prefixes
awplus# show ip bgp multicast 3.3.3.3/16 longer-prefixes
```

show ip bgp neighbors

Use this command to display detailed information on peering connections to all BGP neighbors.

For information on output options, see [“Controlling “show” Command Output” on page 1.35.](#)

Syntax `show ip bgp neighbors [<ipaddr> [advertised-routes|<received>|received-routes|routes]]`

`show ip bgp {multicast|unicast} neighbors [<ipaddr> [advertised-routes|<received>|received-routes|routes]]`

Parameter	Description
<ipaddr>	Specifies the IPv4 address.
advertised-routes	Displays the routes advertised to a BGP neighbor.
<received>	received prefix-filter Displays all received routes, both accepted and rejected.
prefix-filter	Displays the prefix-list filter.
received-routes	Displays the received routes from neighbor. To display all the received routes from the neighbor, configure the BGP soft reconfigure first.
routes	Displays all accepted routes learned from neighbors.
unicast	Specifies a IPv4 unicast address family. This is the default option. Configures parameters relating to the BGP exchange of routes to unicast destinations.
multicast	Specifies a IPv4 multicast address family. Configures parameters relating to the BGP exchange of routes to source addresses of multicast streams.

Mode User Exec and Privileged Exec

Example

```
awplus# show ip bgp neighbors 1.2.3.4 received-routes

awplus# show ip bgp ipv4 unicast neighbors 7.67.7.0 received
prefix-filter
```

Output Figure 38-9: Example output from the `show ip bgp neighbors` command

```
awplus#show ip bgp neighbors
BGP neighbor is 192.10.23.67, remote AS 1, local AS 1, internal
link
  BGP version 4, remote router ID 172.22.10.10
  BGP state = Established, up for 00:00:22
  Last read 00:00:22, hold time is 240, keepalive interval is 60
seconds
  Neighbor capabilities:
    Route refresh: advertised and received (old and new)
    Address family IPv4 Unicast: advertised and received
  Received 3 messages, 0 notifications, 0 in queue
  Sent 3 messages, 0 notifications, 0 in queue
  Route refresh request: received 0, sent 0
  Minimum time between advertisement runs is 5 seconds

For address family: IPv4 Unicast
  BGP table version 1, neighbor version 1
  Index 1, Offset 0, Mask 0x2
  AF-dependant capabilities:
    Graceful restart: advertised, received

  Community attribute sent to this neighbor (both)
  0 accepted prefixes
  0 announced prefixes

Connections established 1; dropped 0
Graceful-restart Status:
  Remote restart-time is 120 sec

Local host: 192.10.23.80, Local port: 33837
Foreign host: 192.10.23.67, Foreign port: 179
Nexthop: 192.10.23.80
Nexthop global: 1111::80
Nexthop local: fe80::203:47ff:fe97:bb79
BGP connection: non shared network
```

show ip bgp neighbors connection-retrytime

Use this command to display the configured connection-retrytime value of the peer at the session establishment time with the neighbor.

For information on output options, see [“Controlling “show” Command Output” on page 1.35.](#)

Syntax `show ip bgp neighbors {<ip-address>} connection-retrytime`
`no show ip bgp neighbors {<ip-address>} connection-retrytime`

Parameter	Description
<code><ip-address></code>	The address of an IPv4 BGP neighbor, in dotted decimal notation A.B.C.D.

Mode Privileged Exec

Example

```
awplus# show ip bgp neighbors 10.11.4.26 connection-
retrytime
```

show ip bgp neighbors hold-time

Use this command to display the configured holdtime value of the peer at the session establishment time with the neighbor.

For information on output options, see [“Controlling “show” Command Output” on page 1.35.](#)

Syntax `show ip bgp neighbors {<ip-address>} hold-time`

Parameter	Description
<code><ip-address></code>	The address of an IPv4 BGP neighbor, in dotted decimal notation A.B.C.D.

Mode Privileged Exec

Example

```
awplus# show ip bgp neighbors 10.11.4.26 hold-time
```

show ip bgp neighbors keepalive

Use this command to display the number of keepalive messages sent to the neighbor from the peer throughout the session.

For information on output options, see [“Controlling “show” Command Output” on page 1.35.](#)

Syntax `show ip bgp neighbors {<ip-address>} keepalive`

Parameter	Description
<code><ip-address></code>	The address of an IPv4 BGP neighbor, in dotted decimal notation A.B.C.D.

Mode Privileged Exec

Example

```
awplus# show ip bgp neighbors 10.11.4.26 keepalive
```

show ip bgp neighbors keepalive-interval

Use this command to display the configured keepalive-interval value of the peer at the session establishment time with the neighbor.

For information on output options, see [“Controlling “show” Command Output” on page 1.35.](#)

Syntax `show ip bgp neighbors {<ip-address>} keepalive-interval`

Parameter	Description
<code><ip-address></code>	The address of an IPv4 BGP neighbor, in dotted decimal notation A.B.C.D.

Mode Privileged Exec

Example

```
awplus# show ip bgp neighbors 10.11.4.26 keepalive-
interval
```

show ip bgp neighbors notification

Use this command to display the number of notification messages sent to the neighbor from the peer throughout the session.

For information on output options, see [“Controlling “show” Command Output” on page 1.35.](#)

Syntax `show ip bgp neighbors {<ip-address>} notification`

Parameter	Description
<code><ip-address></code>	The address of an IPv4 BGP neighbor, in dotted decimal notation A.B.C.D.

Mode Privileged Exec

Example

```
awplus# show ip bgp neighbors 10.11.4.26 notification
```

show ip bgp neighbors open

Use this command to display the number of open messages sent to the neighbor from the peer throughout the session.

For information on output options, see [“Controlling “show” Command Output” on page 1.35.](#)

Syntax `show ip bgp neighbors {<ip-address>} open`

Parameter	Description
<ip-address>	The address of an IPv4 BGP neighbor, in dotted decimal notation A.B.C.D.

Mode Privileged Exec

Example

```
awplus# show ip bgp neighbors 10.11.4.26 open
```

show ip bgp neighbors rcvd-msgs

Use this command to display the number of messages received by the neighbor from the peer throughout the session.

For information on output options, see [“Controlling “show” Command Output” on page 1.35.](#)

Syntax `show ip bgp neighbors {<ip-address>} rcvd-msgs`

Parameter	Description
<ip-address>	The address of an IPv4 BGP neighbor, in dotted decimal notation A.B.C.D.

Mode Privileged Exec

Example

```
awplus# show ip bgp neighbors 10.11.4.26 rcvd-msgs
```

show ip bgp neighbors sent-msgs

Use this command to display the number of messages sent to the neighbor from the peer throughout the session.

For information on output options, see [“Controlling “show” Command Output” on page 1.35.](#)

Syntax `show ip bgp neighbors {<ip-address>} sent-msgs`

Parameter	Description
<code><ip-address></code>	The address of an IPv4 BGP neighbor, in dotted decimal notation A.B.C.D.

Mode Privileged Exec

Example

```
awplus# show ip bgp neighbors 10.11.4.26 sent-msgs
```

show ip bgp neighbors update

Use this command to display the number of update messages sent to the neighbor from the peer throughout the session.

For information on output options, see [“Controlling “show” Command Output” on page 1.35.](#)

Syntax `show ip bgp neighbors {<ip-address>} update`

Parameter	Description
<code><ip-address></code>	The address of an IPv4 BGP neighbor, in dotted decimal notation A.B.C.D.

Mode Privileged Exec

Example

```
awplus# show ip bgp neighbors 10.11.4.26 update
```

show ip bgp paths

Use this command to display BGP path information.

For information on output options, see [“Controlling “show” Command Output” on page 1.35.](#)

Syntax `show ip bgp paths`
`show ip bgp {multicast|unicast} paths`

Parameter	Description
<code>unicast</code>	Specifies a IPv4 unicast address family. This is the default option. Configures parameters relating to the BGP exchange of routes to unicast destinations.
<code>multicast</code>	Specifies a IPv4 multicast address family. Configures parameters relating to the BGP exchange of routes to source addresses of multicast streams.

Mode User Exec and Privileged Exec

Example

```
awplus# show ip bgp paths
```

show ip bgp prefix-list

Use this command to display routes matching the prefix-list.

For information on output options, see [“Controlling “show” Command Output” on page 1.35.](#)

Syntax `show ip bgp prefix-list <list>`
`show ip bgp {multicast|unicast} prefix-list <list>`

Parameter	Description
<code><list></code>	Specifies the name of the IP prefix list.
<code>unicast</code>	Specifies a IPv4 unicast address family. This is the default option. Configures parameters relating to the BGP exchange of routes to unicast destinations.
<code>multicast</code>	Specifies a IPv4 multicast address family. Configures parameters relating to the BGP exchange of routes to source addresses of multicast streams.

Mode User Exec and Privileged Exec

Example

```
awplus# show ip bgp prefix-list mylist
```

show ip bgp quote-regexp

Use this command to display routes matching the AS path regular expression in quotes.

For information on output options, see [“Controlling “show” Command Output” on page 1.35.](#)

Syntax `show ip bgp quote-regexp <expression>`

Parameter	Description
<code><expression></code>	Specifies a regular-expression to match the BGP AS paths

Mode User Exec and Privileged Exec

Example

```
awplus# show ip bgp quote-regexp "myexpression"
```

show ip bgp regexp

Use this command to display routes matching the AS path regular expression.

For information on output options, see [“Controlling “show” Command Output” on page 1.35.](#)

Syntax `show ip bgp regexp <expression>`
`show ip bgp {multicast|unicast} regexp <expression>`

Parameter	Description
<code><expression></code>	Specifies a regular-expression to match the BGP AS paths.
<code>unicast</code>	Specifies a IPv4 unicast address family. This is the default option. Configures parameters relating to the BGP exchange of routes to unicast destinations.
<code>multicast</code>	Specifies a IPv4 multicast address family. Configures parameters relating to the BGP exchange of routes to source addresses of multicast streams.

Mode User Exec and Privileged Exec

Example

```
awplus# show ip bgp regexp myexpression
```

show ip bgp route-map

Use this command to display routes that match the specified route-map.

For information on output options, see [“Controlling “show” Command Output” on page 1.35.](#)

Syntax `show ip bgp route-map <route-map>`
`show ip bgp {multicast|unicast} route-map <route-map>`

Parameter	Description
<code><route-map></code>	Specifies a route-map that is matched.
<code>unicast</code>	Specifies a IPv4 unicast address family. This is the default option. Configures parameters relating to the BGP exchange of routes to unicast destinations.
<code>multicast</code>	Specifies a IPv4 multicast address family. Configures parameters relating to the BGP exchange of routes to source addresses of multicast streams.

Mode User Exec and Privileged Exec

show ip bgp scan

Use this command to display BGP scan status.

For information on output options, see [“Controlling “show” Command Output” on page 1.35.](#)

Syntax `show ip bgp scan`

Mode User Exec and Privileged Exec

Example

```
awplus# show ip bgp scan
```

Output Figure 38-10: Example output from the `show ip bgp scan` command

```
BGP scan is running
BGP scan interval is 60
BGP instance : AS is 11,DEFAULT
Current BGP nexthop cache:
BGP connected route:
 10.10.10.0/24
 10.10.11.0/24
```

show ip bgp summary

Use this command to display a summary of BGP neighbor status.

For information on output options, see [“Controlling “show” Command Output” on page 1.35.](#)

Syntax `show ip bgp summary`
`show ip bgp {multicast|unicast} summary`

Parameter	Description
unicast	Specifies a IPv4 unicast address family. This is the default option. Configures parameters relating to the BGP exchange of routes to unicast destinations.
multicast	Specifies a IPv4 multicast address family. Configures parameters relating to the BGP exchange of routes to source addresses of multicast streams.

Mode User Exec and Privileged Exec

Example

```
awplus# show ip bgp summary
```

Output Figure 38-11: Example output from the `show ip bgp summary` command

```
BGP router identifier 10.10.15.50, local AS number 65000
1 BGP AS-PATH entries
0 BGP community entries
Neighbor V AS MsgRcvd MsgSent TblVer InQ OutQ Up/Down State
PfxRcd
10.10.9.50      4 65000      460    595 0    0    0 00:17:48    3
10.10.14.51    4 100         93    1200 0    0    0 00:42:16
Total number of neighbors 2
```

show ip bgp view

Use this command to view the neighbors of the given instance.

For information on output options, see [“Controlling “show” Command Output” on page 1.35.](#)

Syntax `show ip bgp view <instance> [<ip-address>[/M]]`

Parameter	Description
<code><instance></code>	The name of the instance to display data for.
<code><ip-address></code>	IPv4 address, entered in the form A.B.C.D.
<code>/M</code>	The subnet mask length.

Mode User Exec and Privileged Exec

Example

```
awplus# show ip bgp 128 view instance1 10.10.10.0/24
```

Output Figure 38-12: Example output from the `show ip bgp view` command

```
BGP table version is 0, local router ID is 10.10.10.50
Status codes: s suppressed, d damped, h history, p stale, *
valid, > best, i - internal
Origin codes: i - IGP, e - EGP, ? - incomplete
   Network          Next Hop          Metric LocPrf Weight Path
*>i100.156.70.0/24  10.10.10.52              0         0  i
*>i100.156.71.0/24  10.10.10.52              0         0  i
*>i100.156.72.0/24  10.10.10.52              0         0  i
*>i100.156.73.0/24  10.10.10.52              0         0  i
*>i100.156.74.0/24  10.10.10.52              0         0  i
Total number of prefixes 5
```

Related Commands `show ip bgp neighbors`

show ip bgp view neighbors

Use this command to view the neighbors of the given instance.

For information on output options, see “Controlling “show” Command Output” on page 1.35.

Syntax `show ip bgp view <instance> neighbors`
`show ip bgp view <instance> neighbors [<ip-address>]`

Parameter	Description
<code><instance></code>	The name of the instance to display data for.
<code><ip-address></code>	The IPv4 address of the neighbor, entered in the form A.B.C.D.

Mode User Exec and Privileged Exec

Example

```
awplus# show ip bgp 128 view instance1 neighbors 10.10.10.5
```

Output Figure 38-13: Example output from the `show ip bgp view neighbors` command

```
BGP neighbor is 10.10.10.52, remote AS 10, local AS 10, internal
link
  BGP version 4, remote router ID 10.10.10.52
  BGP state = Established, up for 00:03:22
  Last read 00:00:13, hold time is 90, keepalive interval 30
seconds
  Neighbor capabilities:
    Route refresh: advertised
    Address family IPv4 Unicast: advertised
  Received 8 messages, 0 notifications, 0 in queue
  Sent 8 messages, 0 notifications, 0 in queue
  Route refresh request: received 0, sent 0
  Minimum time between advertisement runs is 5 seconds
For address family: IPv4 Unicast
  Community attribute sent to this neighbor (both)
  5 accepted prefixes
  0 announced prefixes
Connections established 1; dropped 0
Local host: 10.10.10.50, Local port: 179
Foreign host: 10.10.10.52, Foreign port: 36950
Nexthop: 10.10.10.50
Nexthop global: fe80::280:c8ff:feb9:d268
Nexthop local: ::
BGP connection: non shared network
Read thread: on Write thread: off
```

Related Commands [show ip bgp neighbors](#)

show ip bgp view summary

Use this command to view the summary data of neighbors of the given instance.

For information on output options, see “Controlling “show” Command Output” on page 1.35.

Syntax `show ip bgp view <instance> summary`
`show ip bgp view <instance> [{multicast|unicast}] summary`

Parameter	Description
<instance>	The name of the instance to display data for.
unicast	Specifies a IPv4 unicast address family. This is the default option. Configures parameters relating to the BGP exchange of routes to unicast destinations.
multicast	Specifies a IPv4 multicast address family. Configures parameters relating to the BGP exchange of routes to source addresses of multicast streams.

Mode User Exec and Privileged Exec

Example

```
awplus# show ip bgp 128 view instance1 neighbor 10.10.10.5
```

Output The following example shows the summary data of instance named I2.

Figure 38-14: Example output from the `show ip bgp view summary` command

```
BGP router identifier 10.10.10.50, local AS number 10
1 BGP AS-PATH entries
0 BGP community entries

Neighbor V AS MsgRcvd MsgSent TblVer InQ OutQ Up/Down State/PfxRcd
10.10.10.52 4 10 1 2 0 0 0 00:00:07 5
Total number of neighbors 1
```

Related Commands `show ip bgp neighbors`

show ip community-list

Use this command to display routes that match a specified community-list name or number.

For information on output options, see [“Controlling “show” Command Output” on page 1.35.](#)

Syntax `show ip community-list [<listnumber>|<listname>]`

Parameter	Description
<code><listnumber></code>	Specifies the community list number in the range <1-199> as specified by a previously issued ip community-list command.
<code><listname></code>	Specifies the community list name as specified by a previously issued ip community-list command.

Mode User Exec and Privileged Exec

Example

```
awplus# show ip community-list mylist
awplus# show ip community-list 99
```

show ip extcommunity-list

Use this command to display a configured extcommunity-list.

For information on output options, see [“Controlling “show” Command Output” on page 1.35.](#)

Syntax `show ip extcommunity-list [<1-199>|<extcommunity-listname>]`

Parameter	Description
<code><1-199></code>	Extcommunity-list number
<code><extcommunity-listname></code>	Extcommunity-list name

Mode User Exec and Privileged Exec

Example

```
awplus# show ip extcommunity-list 33
```

show ip protocols bgp

Use this command to display BGP process parameters and statistics.

For information on output options, see [“Controlling “show” Command Output” on page 1.35.](#)

Syntax show ip protocols bgp

Mode User Exec and Privileged Exec

Example To display BGP process parameters and statistics, use the command:

```
awplus# show ip protocols bgp
```

Output Figure 38-15: Example output from the **show ip protocols bgp** command

```
Routing Protocol is "bgp 100"
  IGP synchronization is disabled
  Automatic route summarization is disabled
  Default local-preference applied to incoming route is 100
  Redistributing:
  Neighbor(s):
  Address AddressFamily FiltIn FiltOut DistIn DistOut RouteMapIn RouteMapOut Weight
  10.10.10.1                unicast
```

synchronization

Use this command to enable IGP synchronization of Internal BGP (iBGP) learned routes with the Internal Gateway Protocol (IGP) system in the Router Configuration mode or in the Address-Family Configuration mode.

Use the **no** variant of this command to disable this function.

Syntax `synchronization`
`no synchronization`

Default IGP synchronization is disabled.

Mode Router Configuration and Address Family [`ipv4 unicast`|`ipv4 multicast`] mode

Usage Synchronization is used when a BGP router should not advertise routes learned from iBGP neighbors, unless those routes are also present in an IGP (for example, OSPF). Synchronization may be enabled when all the routers in an autonomous system do not speak BGP, and the autonomous system is a transit for other autonomous systems. The **no synchronization** command is used when BGP router can advertise routes learned from its iBGP neighbors without waiting for the IGP reachability to be present.

Example The following example enables IGP synchronization of iBGP routes in Router Configuration.

```
awplus# configure terminal
awplus(config)# router bgp 11
awplus(config-router)# synchronization
```

The following example enables IGP synchronization of iBGP routes in the IPv4-Unicast address family.

```
awplus# configure terminal
awplus(config)# router bgp 11
awplus(config)# address-family ipv4 unicast
awplus(config-af)# synchronization
```

timers (BGP)

Use this command sets the BGP keepalive timer and holdtime timer values.

Use the **no** variant of this command to reset timers to default value.

Syntax `timers bgp <keepalive> <holdtime>`
`no timers bgp`

Parameter	Description
<code><keepalive></code>	<code><0-65535></code> The frequency with which the keepalive messages are sent to the neighbors. The default value is 30 seconds.
<code><holdtime></code>	<code><0-65535></code> The interval after which the neighbor is considered dead if keepalive messages are not received. The default holdtime value is 90 seconds.

Mode Router Configuration

Usage This command is used globally to set or unset the keepalive and holdtime values for all the neighbors.

Example

```
awplus# configure terminal
awplus(config)# router bgp 10
awplus(config-router)# timers bgp 40 120
```

undebg bgp

Use this command to disable BGP debugging functions.

Syntax `undebg bgp [all|dampening|events|filters|fsm|keepalives|nsm|updates]`
`undebg all bgp`

Parameter	Description
<code>all</code>	Disable all debugging for BGP
<code>dampening</code>	Disable debugging for BGP dampening.
<code>events</code>	Disable debugging for BGP events.
<code>filters</code>	Disable debugging for BGP filters.
<code>fsm</code>	Disable debugging for BGP Finite State Machine (FSM).
<code>keepalives</code>	Disable debugging for BGP keepalives.
<code>nsm</code>	Disable debugging for NSM messages.
<code>updates</code>	Disable debugging for BGP updates.

Mode Privileged Exec

Example

```
awplus# undebg bgp events
```

Related Commands [debug bgp](#)

Chapter 39: Route Map Configuration



Introduction.....	39.2
Route-Map.....	39.2

Introduction

This chapter contains a basic Route Map configuration example. For details about the commands used in these examples, or the outputs from validation commands, see [Chapter 40, Route Map Commands](#).

Route-Map

Use route-maps to filter incoming updates from a BGP peer. In this example, a prefix-list `list1` on Peer 1 is configured to deny entry of any routes with the IP address `1.1.1.0/M` ($M = 26, 27, 28$). To test the filter, Peer 2 is configured to generate network addresses `1.1.1.0/27` and `1.1.2.0/24`. To verify, use the [show ip bgp command on page 38.122](#) on Peer 1; it displays Peer 1 receiving updates from only `1.1.2.0/24`.

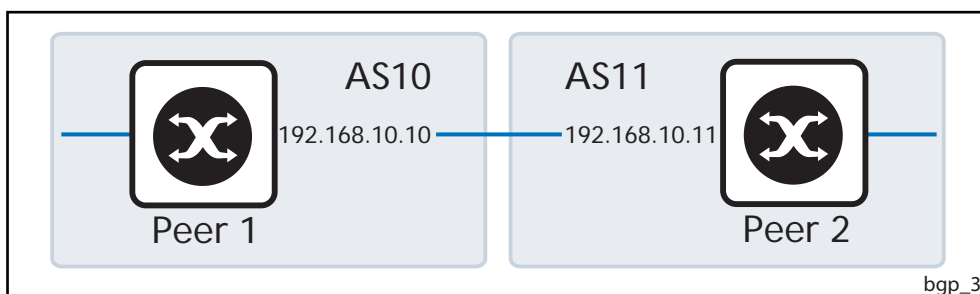

Peer 1

<pre>awplus# configure terminal</pre>	Enter the Global Configuration mode.
<pre>awplus(config)# ip prefix-list prefixlist1 seq 5 deny 1.1.1.0/24 ge 26 le 28 awplus(config)# ip prefix-list prefixlist1 seq 10 permit any</pre>	<p>Create the prefix-list named <code>prefixlist1</code> as shown opposite. <code>prefixlist1</code> contains two entries. The first entry with a deny action is to not match any routes in the <code>1.1.1.0/24</code> range that have prefix lengths from 26 to 28 (inclusive). The second entry allows all other routes.</p> <p>Also note the sequence number (<code>seq 5 seq 10</code>) in the prefix-list specifies the sequence for each entry.</p>
<pre>awplus(config)# route-map routemap1 permit 1</pre>	Enter the route-map mode to set the match operation.
<pre>awplus(config-route-map)# match ip address prefix-list prefixlist1</pre>	<p>Set the match criteria. This match criterion on this route-map entry is to match the incoming route updates against the prefix-list <code>prefixlist1</code>. If a route matches the permit criteria of the prefix-list <code>prefixlist1</code>, then packets are permitted by the route-map, since this route-map entry has a permit action. Because this is the only entry route-map, all routes that are not permitted by this entry route-map will be dropped.</p>
<pre>awplus(config-route-map)# exit</pre>	Exit the Route-map mode and return to Global Configuration mode.

Peer 1 (cont.)

<code>awplus(config)#</code>	
<code>router bgp 10</code>	Define the routing process. The number 10 specifies the AS number of R1.

<code>awplus(config-router)#</code>	
<code>neighbor 192.168.10.11 remote-as 11</code>	Define BGP neighbors. 192.168.10.11 is the IP address of the neighbor (Peer 2) and 11 is the neighbor's AS number.

<code>awplus(config-router)#</code>	
<code>neighbor 192.168.10.11 route-map routemap1 in</code>	The route-map is now applied as the filter for route updates that are received from the neighbor 192.168.10.11. Routes are accepted from the neighbor 192.168.10.11 if they match the permit criteria of route-map routemap1.

Peer 2

<code>awplus(config)#</code>	
<code>router bgp 11</code>	Define the routing process. The number 11 specifies the AS number of Peer 2.

<code>awplus(config-router)#</code>	
<code>neighbor 192.168.10.10 remote-as 10</code>	Define BGP neighbors. 192.168.10.10 is the IP address of the neighbor (Peer 1) and 10 is the neighbor's AS number.

<code>awplus(config-router)#</code>	
<code>network 1.1.1.0/27</code>	Specify a route to be advertised by the BGP routing process.

<code>awplus(config-router)#</code>	
<code>network 1.1.2.0/24</code>	Specify a route to be advertised by the BGP routing process.

Names of Commands Used

ip prefix-list
 neighbor remote-as
 route-map
 match ip address
 network (BGP)

Validation Commands

show ip bgp

Chapter 40: Route Map Commands



Command List	40.2
match as-path.....	40.2
match community.....	40.4
match interface.....	40.5
match ip address.....	40.6
match ip next-hop.....	40.8
match ipv6 address.....	40.10
match ipv6 next-hop.....	40.11
match metric.....	40.12
match origin.....	40.13
match route-type.....	40.14
match tag.....	40.15
route-map.....	40.16
set aggregator.....	40.18
set as-path.....	40.19
set atomic-aggregate.....	40.20
set comm-list delete.....	40.21
set community.....	40.22
set dampening.....	40.24
set extcommunity.....	40.26
set ip next-hop (route map).....	40.27
set ipv6 next-hop.....	40.28
set local-preference.....	40.29
set metric.....	40.30
set metric-type.....	40.31
set origin.....	40.32
set originator-id.....	40.33
set tag.....	40.34
set weight.....	40.35
show route-map.....	40.36

Command List

This chapter provides an alphabetical reference for route map commands. These commands can be divided into the following categories:

- **route-map** command, used to create a route map and/or route map entry, and to put you into route map mode
- **match** commands, used to determine which routes or BGP update messages the route map applies to
- **set** commands, used to modify matching routes or BGP update messages.

match as-path

Use this command to add an autonomous system (AS) path match clause to a route map entry. Specify the AS path attribute value or values to match by specifying the name of an AS path access list. To create the AS path access list, enter Global Configuration mode and use the **ip as-path access-list** command.

A BGP update message matches the route map if its attributes include AS path values that match the AS path access list.

Each entry of a route map can only match against one AS path access list in one AS path match clause. If the route map entry already has an AS path match clause, entering this command replaces that match clause with the new clause.

Note that AS path access lists and route map entries both specify an action of deny or permit. The action in the AS path access list determines whether the route map checks update messages for a given AS path value. The route map action and its **set** clauses determine what the route map does with update messages that contain that AS path value.

Use the **no** variant of this command to remove the AS path match clause from a route map entry.

Syntax `match as-path <as-path-listname>`
`no match as-path [<as-path-listname>]`

Parameter	Description
<code><as-path-listname></code>	Specifies an AS path access list name.

Mode Route-map Configuration

Usage This command is valid for BGP update messages only.

Example To add entry 34 to the route map called `myroute`, which will discard update messages if they contain the AS path values that are included in `myaccesslist`, use the commands:

```
awplus# configure terminal
awplus(config)# route-map myroute deny 34
awplus(config-route-map)# match as-path myaccesslist
```

Related Commands ip as-path access-list
 route-map
 set as-path
 show route-map

match community

Use this command to add a community match clause to a route map entry. Specify the community value or values to match by specifying a community list. To create the community list, enter Global Configuration mode and use the [ip community-list](#) command.

A BGP update message matches the route map if its attributes include community values that match the community list.

Each entry of a route map can only match against one community list in one community match clause. If the route map entry already has a community match clause, entering this command replaces that match clause with the new clause.

Note that community lists and route map entries both specify an action of deny or permit. The action in the community list determines whether the route map checks update messages for a given community value. The route map action and its **set** clauses determine what the route map does with update messages that contain that community value.

Use the **no** variant of this command to remove the community match clause from a route map.

Syntax `match community {<community-listname> | <1-99> | <100-199>} [exact-match]`
`no match community [<community-listname> | <1-99> | <100-199> | exact-match]`

Parameter	Description
<code><community-listname></code>	The community list name or number.
<code><1-99></code>	Community list number (standard range)
<code><100-199></code>	Community list number (expanded range)
<code>exact-match</code>	Exact matching of communities

Mode Route-map Configuration

Usage This command is valid for BGP update messages only.

Communities are used to group and filter routes. They are designed to provide the ability to apply policies to large numbers of routes by using match and set commands. Community lists are used to identify and filter routes by their common attributes.

Example To add entry 3 to the route map called `myroute`, which will process update messages if they contain the community values that are included in `mylist`, use the commands:

```
awplus# configure terminal
awplus(config)# route-map myroute permit 3
awplus(config-route-map)# match community mylist
```

Related Commands [ip community-list](#)
[route-map](#)
[set comm-list delete](#)
[set community](#)
[show route-map](#)

match interface

Use this command to add an interface match clause to a route map entry. Specify the interface name to match.

A route matches the route map if its interface matches the interface name.

Each entry of a route map can only match against one interface in one interface match clause. If the route map entry already has an interface match clause, entering this command replaces that match clause with the new clause.

Use the **no** variant of this command to remove the interface match clause from the route map entry.

Syntax `match interface <interface>`
`no match interface`

Parameter	Description
<code><interface></code>	The VLAN to match, e.g. <code>vlan2</code> .

Mode Route-map Configuration

Usage This command is valid for RIP and OSPF routes only.

Example To add entry 10 to the route map called mymap1, which will process routes if they use the interface `vlan1`, use the commands:

```
awplus# configure terminal
awplus(config)# route-map mymap1 permit 10
awplus(config-route-map)# match interface vlan1
```

Related Commands `match ip address`
`match ip next-hop`
`match route-type`
`match tag`
`route-map`
`show route-map`

match ip address

Use this command to add an IP address prefix match clause to a route map entry. You can specify the prefix or prefixes to match by either:

- specifying the name of an access list. To create the access list, enter Global Configuration mode and use the **access-list** command.
- specifying the name of a prefix list. To create the prefix list, enter Global Configuration mode and use the **ip prefix-list** command.

A route matches the route map entry if the route's prefix matches the access list or prefix list.

Each entry of a route map can have at most one access list-based IP address match clause and one prefix list-based IP address match clause. If the route map entry already has one of these match clauses, entering this command replaces that match clause with the new clause.

Note that access lists, prefix lists and route map entries all specify an action of deny or permit. The action in the access list or prefix list determines whether the route map checks update messages and routes for a given prefix. The route map action and its **set** clauses determine what the route map does with routes that contain that prefix.

Use the **no** variant of this command to remove the IP address match clause from a route map entry. To remove a prefix list-based match clause you must also specify the **prefix-list** parameter.

Syntax

```
match ip address {<accesslistID>|prefix-list <prefix-listname>}
no match ip address [<accesslistID>]
no match ip address prefix-list <prefix-listname>
```

Parameter	Description
<accesslistID>	{<access-list-name> <1-199> <1300-2699>} The IP access list name or number
<access-list-name>	The IP access list name
<1-199>	The IP access list number
<1300-2699>	The IP access list number (expanded range)
prefix-list	Use an IP prefix list to specify which prefixes to match
<prefix-listname>	The prefix list name

Mode Route-map Configuration

Usage The **match ip address** command specifies the IP address to be matched. If there is a match for the specified IP address, and **permit** is specified, the route is redistributed or controlled, as specified by the set action. If the match criteria are met, and **deny** is specified then the route is **not** redistributed or controlled. If the match criteria are **not** met, the route is neither accepted nor forwarded, irrespective of **permit** or **deny** specifications.

This command is valid for routes in BGP update messages, and for OSPF and RIP routes.

Examples To add entry 3 to the route map called `myroute`, which will process routes that match the ACL called `List1`, use the commands:

```
awplus# configure terminal
awplus(config)# route-map myroute permit 3
awplus(config-route-map)# match ip address List1
```

To add entry 3 to the route map called `rmap1`, which will process routes that match the prefix list called `mylist`, use the commands:

```
awplus# configure terminal
awplus(config)# route-map rmap1 permit 3
awplus(config-route-map)# match ip address prefix-list mylist
```

Related Commands

- [access-list \(extended numbered\)](#)
- [access-list \(standard numbered\)](#)
- [ip prefix-list](#)
- [route-map](#)
- [show ip access-list](#)
- [show route-map](#)

match ip next-hop

Use this command to add a next-hop match clause to a route map entry. You can specify the next hop to match by either:

- specifying the name of an access list. To create the access list, enter Global Configuration mode and use the **access-list** command.
- specifying the name of a prefix list. To create the prefix list, enter Global Configuration mode and use the **ip prefix-list** command.

A route matches the route map if the route's next hop matches the access list or prefix list.

Each entry of a route map can have at most one access list-based next-hop match clause and one prefix list-based next-hop match clause. If the route map entry already has one of these match clauses, entering this command replaces that match clause with the new clause.

Note that access lists, prefix lists and route map entries all specify an action of deny or permit. The action in the access list or prefix list determines whether the route map checks update messages and routes for a given next-hop value. The route map action and its **set** clauses determine what the route map does with update messages and routes that contain that next hop.

Use the **no** variant of this command to remove the next-hop match clause from a route map entry. To remove a prefix list-based match clause you must also specify the prefix-list parameter.

Syntax

```
match ip next-hop {<accesslistID>|prefix-list <prefix-listname>}
no match ip next-hop [<accesslistID>]
no match ip next-hop prefix-list [<prefix-listname>]
```

Parameter	Description
<accesslistID>	{<access-list-name> <1-199> <1300-2699>} The IP access list name or number
<access-list-name>	The IP access list name
<1-199>	The IP access list number
<1300-2699>	The IP access list number (expanded range)
prefix-list	Use an IP prefix list to specify which next hop to match
<prefix-listname>	The prefix list name.

Mode Route-map Configuration

Usage This command is valid for BGP update messages and OSPF and RIP routes.

Examples To add entry 3 to the route map called `rmap1`, which will process routes whose next hop matches the ACL called `mylist`, use the commands:

```
awplus# configure terminal
awplus(config)# route-map rmap1 permit 3
awplus(config-route-map)# match ip next-hop mylist
```

To add entry 3 to the route map called `mymap`, which will process routes whose next hop matches the prefix list called `list1`, use the commands:

```
awplus# configure terminal
awplus(config)# route-map mymap permit 3
awplus(config-route-map)# match ip next-hop prefix-list list1
```

Related Commands

- [access-list \(extended numbered\)](#)
- [access-list \(standard numbered\)](#)
- [ip prefix-list](#)
- [route-map](#)
- [show ip access-list](#)
- [show ip prefix-list](#)
- [show route-map](#)

match ipv6 address

Use this command to specify the match address of route.

Use the **no** variant of this command to remove the `match ipv6 address` entry.

Syntax `match ipv6 address {<access-list-name>|prefix-list <prefix-listname>}`
`no match ipv6 address [<access-list-name>|prefix-list <prefix-listname>]`

Parameter	Description
<code><access-list-name></code>	The name of the IPv6 access list that specifies criteria for the addresses to match. Valid only with BGP and RIPng.
<code><prefix-listname></code>	The name of the IPv6 prefix list that specifies criteria for the addresses to be matched. Valid only with BGP and RIPng.

Mode Route-map Configuration

Usage The `match ipv6 address <access-list>` command specifies the IPv6 address to be matched. If there is a match for the specified IPv6 address, and `permit` is specified, the route is redistributed or controlled as specified by the set action. If the match criteria are met, and `deny` is specified, the route is not redistributed or controlled. If the match criteria are not met, the route is neither accepted nor forwarded, irrespective of `permit` or `deny` specifications.

The `match ipv6 address prefix-list` command specifies the entries of prefix-lists to be matched. If there is a match for the specified prefix-list entries, and `permit` is specified, the route is redistributed or controlled as specified by the set action. If the match criteria are met, and `deny` is specified, the route is not redistributed or controlled. If the match criteria are not met, the route is neither accepted nor forwarded, irrespective of `permit` or `deny` specifications.

Examples

```
awplus# configure terminal
awplus(config)# route-map rmap1 deny 1
awplus(config-route-map)# match ipv6 address rmap1

awplus# configure terminal
awplus(config)# route-map rmap1 permit 3
awplus(config-route-map)# match ipv6 address prefix-list mylist
```

match ipv6 next-hop

Use this command to specify a next-hop address to be matched by the route-map.

Use the **no** variant of this command to disable this function

Syntax

```
match ipv6 next-hop {<access-list-name>|<ipv6-addr>|prefix-list
<prefix-listname>}

no match ipv6 next-hop [<access-list-name>|<ipv6-addr>|prefix-list
[<prefix-listname>]]
```

Parameter	Description
<code><access-list-name></code>	The name of the IPv6 access list that specifies criteria for the addresses to match.
<code><ipv6-addr></code>	The IPv6 address of the next hop. The IPv6 address uses the format X:X::X:X.
<code><prefix-listname></code>	The name of the IPv6 prefix list that specifies criteria for the addresses to be matched.

Mode Route-map Configuration

Usage The `match ipv6 next-hop` command specifies the next-hop address to be matched. If there is a match for the specified next-hop address, and `permit` is specified, the route is redistributed or controlled as specified by the set action. If the match criteria are met, and `deny` is specified, the route is not redistributed or controlled. If the match criteria are not met, the route is neither accepted nor forwarded, irrespective of `permit` or `deny` specifications.

Note This command is valid only for BGP.



Example

```
awplus# configure terminal
awplus(config)# route-map rmap1 permit 3
awplus(config-route-map)# match ipv6 next-hop 3ffe::1
```

match metric

Use this command to add a metric match clause to a route map entry. Specify the metric value to match.

A route matches the route map if its metric matches the route map's metric. A BGP update message matches the route map if its MED attribute value matches the route map's metric.

Each entry of a route map can only match against one metric value in one metric match clause. If the route map entry already has a metric match clause, entering this command replaces that match clause with the new clause.

Use the **no** variant of this command to remove the metric match clause from the route map entry.

Syntax `match metric <metric>`
`no match metric [<metric>]`

Parameter	Description
<code><metric></code>	<code><0-4294967295></code> Specifies the metric value.

Mode Route-map Configuration

Usage This command is valid for BGP update messages and OSPF and RIP routes.

Example To stop entry 3 of the route map called `myroute` from processing routes with a metric of 888999, use the commands:

```
awplus# configure terminal
awplus(config)# route-map myroute permit 3
awplus(config-route-map)# no match metric 888999
```

Related Commands [route-map](#)
[set metric](#)
[show route-map](#)

match origin

Use this command to add an origin match clause to a route map entry. Specify the origin attribute value to match.

A BGP update message matches the route map if its origin attribute value matches the route map's origin value.

Each entry of a route map can only match against one origin in one origin match clause. If the route map entry already has an origin match clause, entering this command replaces that match clause with the new clause.

Use the **no** variant of this command to remove the origin match clause from the route map entry.

Syntax `match origin {egp|igp|incomplete}`
`no match origin [egp|igp|incomplete]`

Parameter	Description
egp	Learned from an exterior gateway protocol
igp	Learned from a local interior gateway protocol
incomplete	Of unknown heritage, for example a static route

Mode Route-map Configuration

Usage The origin attribute defines the origin of the path information. The **egp** parameter is indicated as an **e** in the routing table, and it indicates that the origin of the information is learned via Exterior Gateway Protocol. The **igp** parameter is indicated as an **i** in the routing table, and it indicates the origin of the path information is interior to the originating AS. The **incomplete** parameter is indicated as a **?** in the routing table, and indicates that the origin of the path information is unknown or learned through other means. If a static route is redistributed into BGP, the origin of the route is incomplete.

The **match origin** command specifies the origin to be matched. If there is a match for the specified origin, and **permit** is specified, the route is redistributed or controlled as specified by the set action. If the match criteria are met, and **deny** is specified, the route is not redistributed or controlled. If the match criteria are not met, the route is neither accepted nor forwarded, irrespective of **permit** or **deny** specifications.

This command is valid for BGP update messages only.

Example To add entry 34 to the route map called "rmap1", which will drop externally-originated routes, use the commands:

```
awplus# configure terminal
awplus(config)# route-map myroute deny 34
awplus(config-route-map)# match origin egp
```

Related Commands [route-map](#)
[set origin](#)
[show route-map](#)

match route-type

Use this command to add an external route-type match clause to a route map entry. Specify whether to match OSPF type-1 external routes or OSPF type-2 external routes.

An OSPF route matches the route map if its route type matches the route map's route type.

Each entry of a route map can only match against one route type in one match clause. If the route map entry already has a route type match clause, entering this command replaces that match clause with the new clause.

Use the **no** variant of this command to remove the route type match clause from the route map entry.

Syntax

```
match route-type external {type-1|type-2}
no match route-type external [type-1|type-2]
```

Parameter	Description
type-1	OSPF type-1 external routes
type-2	OSPF type-2 external routes

Mode Route-map Configuration

Usage Use the **match route-type external** command to match specific external route types. AS-external LSA is either Type-1 or Type-2. **external type-1** matches only Type 1 external routes, and **external type-2** matches only Type 2 external routes.

This command is valid for OSPF routes only.

Example To add entry 10 to the route map called `mymap1`, which will process type-1 external routes, use the commands:

```
awplus# configure terminal
awplus(config)# route-map mymap1 permit 10
awplus(config-route-map)# match route-type external type-1
```

Related Commands

- match interface
- match ip address
- match ip next-hop
- match tag
- route-map
- set metric-type
- show route-map

match tag

Use this command to add a tag match clause to a route map entry. Specify the route tag value to match.

An OSPF route matches the route map if it has been tagged with the route map's tag value. Routes can be tagged through OSPF commands or through another route map's set clause.

Each entry of a route map can only match against one tag in one match clause. If the route map entry already has a tag match clause, entering this command replaces that match clause with the new clause.

Use the **no** variant of this command to remove the tag match clause from the route map entry.

Syntax `match tag <0-4294967295>`
`no match tag [<0-4294967295>]`

Mode Route-map Configuration

Usage This command is valid for OSPF routes only.

Example To add entry 10 to the route map called `mymap1`, which will process routes that are tagged 100, use the following commands:

```
awplusc# onfigure terminal
awplus(config)# route-map mymap1 permit 10
awplus(config-route-map)# match tag 100
```

Related Commands `match interface`
`match ip address`
`match ip next-hop`
`match route-type`
`route-map`
`set tag`
`show route-map`

route-map

Use this command to configure a route map entry, and to specify whether the device will process or discard matching routes and BGP update messages.

The switch uses a name to identify the route map, and a sequence number to identify each entry in the route map.

The **route-map** command puts you into route-map configuration mode. In this mode, you can use the following:

- one or more of the **match** commands to create match clauses. These specify what routes or update messages match the entry.
- one or more of the **set** commands to create set clauses. These change the attributes of matching routes or update messages.

Use the **no** variant of this command to delete a route map or to delete an entry from a route map.

Syntax `route-map <mapname> {deny|permit} <seq>`
`no route-map <mapname>`
`no route-map <mapname> {deny|permit} <seq>`

Parameter	Description
<mapname>	A name to identify the route map
deny	The route map causes a routing process to discard matching routes or BGP update messages
permit	The route map causes a routing process to use matching routes or BGP update messages
<seq>	<1-65535> The sequence number of the entry. You can use this parameter to control the order of entries in this route map.

Mode Global Configuration

Usage Route maps allow you to control and modify routing information by filtering routes and setting route attributes. You can apply route maps when the device:

- processes BGP update messages that it has received from a peer
- prepares BGP update messages to send to peers
- redistributes routes from one routing protocol into another
- redistributes static routes into routing protocols
- uses BGP route flap dampening

When a routing protocol passes a route or update message through a route map, it checks the entries in order of their sequence numbers, starting with the lowest numbered entry.

If it finds a match on a route map with an action of permit, then it applies any set clauses and accepts the route. Having found a match, the route is not compared against any further entries of the route map.

If it finds a match on a route map with an action of deny, it will discard the matching route.

If it does not find a match, it discards the route or update message. This means that route maps end with an implicit deny entry. To permit all non-matching routes or update messages, end your route map with an entry that has an action of **permit** and no match clause.

Examples To enter route-map mode for entry 1 of the route map called `route1`, and then add a match and set clause to it, use the commands:

```
awplus# configure terminal
awplus(config)# route-map route1 permit 1
awplus(config-route-map)# match as-path 60
awplus(config-route-map)# set weight 70
```

Note how the prompt changes when you go into route map configuration mode.

To make the device process non-matching update messages instead of discarding them, add a command like the following one:

```
awplus(config)# route-map route1 permit 100
```

Related Commands `show route-map`

For BGP:

```
bgp dampening
neighbor default-originate
neighbor route-map
neighbor unsuppress-map
network (BGP)
redistribute route-map
show ip bgp route-map
```

For OSPF:

```
default-information originate (OSPF)
redistribute (OSPF)
```

For RIP:

```
redistribute (RIP)
```

set aggregator

Use this command to add an aggregator set clause to a route map entry.

When a BGP update message matches the route map entry, the device sets the update's aggregator attribute. The aggregator attribute specifies the AS and IP address of the device that performed the aggregation.

Use the **no** variant of this command to remove the set clause.

Syntax `set aggregator as <asnum> <ip-address>`
`no set aggregator as [<asnum> <ip-address>]`

Parameter	Description
<asnum>	The AS number of the aggregator.
<ip-address>	The IP address of the aggregator.

Mode Route-map Configuration

Usage An Autonomous System (AS) is a collection of networks under a common administration sharing a common routing strategy. It is subdivided by areas, and is assigned a unique 16-bit number. Use the **set aggregator** command to assign an AS number for the aggregator.

This command is valid for BGP update messages only.

Example To use entry 3 of the route map called `myroute` to set the aggregator attribute to 43 10.10.0.3 in matching update messages, use the commands:

```
awplus# configure terminal
awplus(config)# route-map myroute permit 3
awplus(config-route-map)# set aggregator as 43 10.10.0.3
```

Related Commands [route-map](#)
[show route-map](#)

set as-path

Use this command to add an AS path set clause to a route map entry.

When a BGP update message matches the route map entry, the device prepends the specified Autonomous System Number (ASN) or ASNs to the update's AS path attribute.

The AS path attribute is a list of the autonomous systems through which the announcement for the prefix has passed. As prefixes pass between autonomous systems, each autonomous system adds its ASN to the beginning of the list. This means that the AS path attribute can be used to make routing decisions.

Use the **no** variant of this command to remove the set clause.

Syntax `set as-path prepend <1-65535> [<1-65535>]...`
`no set as-path prepend [<1-65535> [<1-65535>]...]`

Parameter	Description
<code>prepend</code>	Prepends the autonomous system path.
<code><1-65535></code>	The number to prepend to the AS path. If you specify multiple ASNs, separate them with spaces.

Mode Route-map mode

Usage Use the **set as-path** command to specify an autonomous system path. By specifying the length of the AS-Path, the device influences the best path selection by a neighbor. Use the **prepend** parameter with this command to prepend an AS path string to routes increasing the AS path length.

This command is valid for BGP update messages only.

Example To use entry 3 of the route map called `myroute` to prepend ASN 8 and 24 to the AS path of matching update messages, use the commands:

```
awplus# configure terminal
awplus(config)# route-map myroute permit 3
awplus(config-route-map)# set as-path prepend 8 24
```

Related Commands `match as-path`
`route-map`
`show route-map`

set atomic-aggregate

Use this command to add an atomic aggregate set clause to a route map entry.

When a BGP update message matches the route map entry, the device adds the atomic aggregate attribute to the update.

Use the **no** variant of this command to remove the set clause.

Syntax `set atomic-aggregate`
`no set atomic-aggregate`

Mode Route-map Configuration

Usage This command is valid for BGP update messages only.

Example To use entry 3 of the route map called `rmap1` to add the atomic aggregator attribute to matching update messages, use the commands:

```
awplus# configure terminal
awplus(config)# route-map rmap1 permit 3
awplus(config-route-map)# set atomic-aggregate
```

Related Commands `route-map`
`show route-map`

set comm-list delete

Use this command to delete one or more communities from the community attribute of a BGP update message. Specify the communities to delete by specifying a community list. To create the community list, enter Global Configuration mode and use the [ip community-list](#) command.

When a BGP update message matches the route map entry, the device deletes the specified communities from the update's community attribute.

Use the **no** variant of this command to stop deleting the communities.

Syntax `set comm-list {<1-199>|<100-199>|<word>} delete`
`no set comm-list {<1-199>|<100-199>|<word>} delete`

Parameter	Description
<1-99>	Standard community-list number.
<100-199>	Expanded community-list number.
<word>	Name of the Community-list.

Mode Route-map Configuration

Usage This command is valid for BGP update messages only.

Example To use entry 3 of the route map called `myroute` to delete the communities in community list 34 from matching update messages, use the commands:

```
awplus# configure terminal
awplus(config)# route-map myroute permit 3
awplus(config-route-map)# set comm-list 34 delete
```

Related Commands [ip community-list](#)
[match community](#)
[route-map](#)
[set community](#)
[show route-map](#)

set community

Use this command to add a community set clause to a route map entry.

When a BGP update message matches the route map entry, the device takes one of the following actions:

- changes the update's community attribute to the specified value or values, or
- adds the specified community value or values to the update's community attribute, if you specify the **additive** parameter after specifying another parameter. or
- removes the community attribute from the update, if you specify the **none** parameter

Use the **no** variant of this command to remove the set clause.

Syntax

```
set community {[<1-65535>][AA:NN] [internet] [local-AS]
[no-advertise] [no-export] [additive]}

no set community {[AA:NN] [internet] [local-AS] [no-advertise]
[no-export] [additive]}

set community none

no set community none
```

Parameter	Description
<1-65535>	The AS number of the community as an integer not in AA:NN format.
AA:NN	The Autonomous System (AS) number of the community, in AA:NN format. AS numbers are assigned to the regional registries by the IANA (www.iana.org) and can be obtained from the registry in your region. AA and NN are both integers from 1 to 65535. AA is the AS number; NN is a value chosen by the ASN administrator.
local-AS	The community of routes that must not be advertised to external BGP peers (this includes peers in other members' Autonomous Systems inside a BGP confederation).
internet	The community of routes that can be advertised to all BGP peers.
no-advertise	The community of routes that must not be advertised to other BGP peers.
no-export	The community of routes that must not be advertised outside a BGP confederation boundary (a standalone Autonomous System that is not part of a confederation should be considered a confederation itself).
none	The device removes the community attribute from matching update messages.
additive	The device adds the specified community value to the update message's community attribute, instead of replacing the existing attribute. By default this parameter is not included, so the device replaces the existing attribute.

Mode Route-map Configuration

Usage This command is valid for BGP update messages only.

Examples To use entry 3 of the route map called `rmap1` to put matching routes into the no-advertise community, use the commands:

```
awplus# configure terminal
awplus(config)# route-map rmap1 permit 3
awplus(config-route-map)# set community no-advertise
```

To use entry 3 of the route map called `rmap1` to put matching routes into several communities, use the commands:

```
awplus# configure terminal
awplus(config)# route-map rmap1 permit 3
awplus(config-route-map)# set community 10:01 23:34 12:14 no-export
```

To use entry 3 of the route map called `rmap1` to put matching routes into a single AS community numbered 16384, use the commands:

```
awplus# configure terminal
awplus(config)# route-map rmap1 permit 3
awplus(config-route-map)# set community 16384 no-export
```

Related Commands

- `match community`
- `route-map`
- `set aggregator`
- `set comm-list delete`
- `set extcommunity`
- `show route-map`

set dampening

Use this command to add a route flap dampening set clause to a route map entry.

Also use the route map by specifying it in the command `bgp dampening routemap` command.

When a route matches the route map entry, the device enables route flap dampening for that route. If the set clause includes dampening parameter values, the device uses those values when dampening the matching route.

Use the `no` variant of this command to remove the set clause. This disables dampening on matching routes.

Syntax

```
set dampening
set dampening [<reachtime>]
set dampening <reachtime> [<reuse> <suppress> <maxsuppress>]
  [<unreachtime>]
no set dampening
no set dampening [<reachtime>]
no set dampening <reachtime> [<reuse> <suppress> <maxsuppress>]
  [<unreachtime>]
```

Parameter	Description
<code><reachtime></code>	<p><code><1-45></code></p> <p>The time it takes, in minutes, for the route's instability penalty to halve if the route remains stable. The instability penalty is called the Figure of Merit (FoM). For example, if reachtime is 15, the FoM of a stable route halves over a 15 minute period, quarters over a 30 minute period, and so on.</p> <p>The default is 15 minutes.</p>
<code><reuse></code>	<p><code><1-20000></code></p> <p>The value that the instability penalty (FoM) must reach for the device to use a suppressed route again. Once a route is suppressed, it remains suppressed until its FoM falls below this threshold. Reuse must not exceed suppress. The default is 750.</p>
<code><suppress></code>	<p><code><1-20000></code></p> <p>The instability penalty (FoM) at which the route is suppressed. Suppress must be greater than or equal to reuse.</p> <p>If suppress is less than 1000, a route is suppressed when it becomes unreachable for the first time. The default is 2000.</p>
<code><maxsuppress></code>	<p><code><1-255></code></p> <p>A number that is multiplied by reachtime to give the maximum time in minutes for which a suppressed route must remain stable in order to become unsuppressed. The lowest maxsuppress value of 1 gives a maximum suppression time of 1 x reachtime, and the highest maxsuppress value of 255 gives a maximum suppression time of 255 x reachtime.</p> <p>For example, if reachtime is 15 and maxsuppress is 4, the route is unsuppressed after 60 minutes of stability even if its FoM still exceeds reuse. The default is 4.</p>

Parameter (cont.)	Description (cont.)
<code><unreachtime></code>	<code><1-45></code> The time it takes, in minutes, for the route's instability penalty to halve if the route remains unstable. The default value is 15 minutes.

Mode Route-map Configuration

Usage The **suppress** value must be greater than or equal to the **reuse** value.

Set the unreachability half-life time to be equal to, or greater than, reachability half-life time. The suppress-limit value must be greater than or equal to the reuse limit value.

This command is valid for BGP routes only.

Example To use entry 24 of the route map called R1 to enable dampening of matching routes and set the dampening parameters, use the commands:

```
awplus# configure terminal
awplus(config)# route-map R1 permit 24
awplus(config-route-map)# set dampening 20 333 534 30
```

Related Commands [bgp dampening](#)
[route-map](#)
[show route-map](#)

set extcommunity

Use this command to add an extended community set clause to a route map entry. A route map entry can have a route target extended community set clause, a site-of-origin extended community set clause, or both.

When a BGP update message matches the route map entry, the device sets the update's extended community attribute to the specified value or values.

Use the **no** variant of this command to remove the set clause.

Syntax `set extcommunity {rt|soo} <extcomm-number>`
`no set extcommunity {rt|soo} [<extcomm-number>]`

Parameter	Description
rt	Configure a route target extended community. This consists of routers that will receive matching routes.
soo	Configure a site-of-origin extended community. This consists of routers that will inject matching routes into BGP.
<extcomm-number>	The extended community number, in the format AA:NN or IPADD:N

Mode Route-map Configuration

Usage This command is valid for BGP update messages only.

Examples To use entry 3 of the route map called `rmap1` to set the route target extended community attribute to 06:01, use the commands:

```
awplus# configure terminal
awplus(config)# route-map rmap1 permit 3
awplus(config-route-map)# set extcommunity rt 06:01
```

To instead specify the extended community number in dotted decimal notation, use the command:

```
awplus# configure terminal
awplus(config)# route-map rmap1 permit 3
awplus(config-route-map)# set extcommunity rt 0.0.0.6:01
```

To use entry 3 of the route map called `rmap1` to set the site-of-origin extended community attribute to 06:01, use the commands:

```
awplus# configure terminal
awplus(config)# route-map rmap1 permit 3
awplus(config-route-map)# set extcommunity soo 06:01
```

To instead specify the extended community number in dotted decimal notation, use the command:

```
awplus# configure terminal
awplus(config)# route-map rmap1 permit 3
awplus(config-route-map)# set extcommunity soo 0.0.0.6:01
```

Related Commands [match community](#)
[route-map](#)
[set comm-list delete](#)
[set community](#)
[show route-map](#)

set ip next-hop (route map)

Use this command to add a next-hop set clause to a route map entry.

When a route or BGP update message matches the route map entry, the device sets the route's next hop to the specified IP address.

Use the **no** variant of this command to remove the set clause.

Syntax `set ip next-hop <ip-address>`
`no set ip next-hop [<ip-address>]`

Parameter	Description
<code><ip-address></code>	The IP address of the next hop, entered in the form A.B.C.D.

Mode Route-map Configuration

Usage Use this command to set the next-hop IP address to the routes.

This command is valid for BGP update messages, and OSPF and RIP routes.

Example To use entry 3 of the route map called `mymap` to give matching routes a next hop of 10.10.0.67, use the commands:

```
awplus# configure terminal
awplus(config)# route-map mymap permit 3
awplus(config-route-map)# set ip next-hop 10.10.0.67
```

Related Commands [match ip next-hop](#)
[route-map](#)
[show route-map](#)

set ipv6 next-hop

Use this command to set a next hop-address.

Use the **no** variant of this command to delete an entry.

Syntax `set ipv6 next-hop {<ipv6-addr-global>|local <ipv6-addr>}`
`no set ipv6 next-hop [<ipv6-addr-global>|local [<ipv6-addr>]]`

Parameter	Description
<code><ipv6-addr-global></code>	The IPv6 global address of next hop. The IPv6 address uses the format X:X::X:X.
<code>local</code>	Specifies that the address is local.
<code><ipv6-addr></code>	The IPv6 local address of next hop. The IPv6 address uses the format X:X::X:X.

Mode Route-map Configuration

Usage Use this command to set the next-hop IPv6 address to the routes.

This command is valid only for BGP.

Examples

```
awplus# configure terminal
awplus(config)# route-map rmap1 permit 3
awplus(config-route-map)# set ipv6 next-hop local
                             fe80::203:47ff:fe97:66dc
awplus(config-route-map)# no set ipv6 next-hop
```

set local-preference

This command changes the default local preference value.

The local preference indicates the BGP local preference path attribute when there are multiple paths to the same destination. The path with the higher preference is chosen. Use this command to define the preference of a particular path. The preference is sent to all routers and access servers in the local autonomous system.

The **no** variant of this command reverts to the default setting.

Syntax `set local-preference <pref-value>`
`no set local-preference [<pref-value>]`

Parameter	Description
<code><pref-value></code>	<code><0-4294967295></code> Configure local preference value. The default local preference value is 100.

Mode Route-map Configuration

Examples

```

awplus# configure terminal
awplus(config)# route-map rmap1 permit 3
awplus(config-route-map)# set local-preference 2345555

awplus# configure terminal
awplus(config)# router bgp 100
awplus(config-route-map)# no set local-preference

```

Related Commands For related Route Map commands:

[route-map](#)
[show route-map](#)

For related BGP commands:

[bgp default local-preference](#)
[neighbor route-map](#)

set metric

Use this command to add a metric set clause to a route map entry.

When a route or BGP update message matches the route map entry, the device takes one of the following actions:

- changes the metric (or for BGP, the MED attribute value) to the specified value, or
- adds or subtracts the specified value from the metric or MED attribute, if you specify **+** or **-** before the value (for example, to increase the metric by 2, enter **+2**)

Use the **no** variant of this command to remove the set clause.

Syntax `set metric {+<metric-value>|-<metric-value>|<metric-value>}`
`no set metric [+<metric-value>|-<metric-value> |<metric-value>]`

Parameter	Description
+	Increase the metric or MED attribute by the specified amount.
-	Decrease the metric or MED attribute by the specified amount.
<metric-value>	<0-4294967295> The new metric or MED attribute value, or the amount by which to increase or decrease the existing value.

Mode Route-map Configuration

Usage For BGP, if you want the device to compare MED values in update messages from peers in different ASes, also enter the command **bgp always-compare-med**. The device always compares MED values in update messages from peers in the same AS.

This command is valid for BGP update messages, and OSPF and RIP routes.

Examples To use entry 3 of the route map called `rmap1` to give matching routes a metric of 600, use the commands:

```
awplus# configure terminal
awplus(config)# route-map rmap1 permit 3
awplus(config-route-map)# set metric 600
```

To use entry 3 of the route map called `rmap1` to increase the metric of matching routes by 2, use the commands:

```
awplus# configure terminal
awplus(config)# route-map rmap1 permit 3
awplus(config-route-map)# set metric +2
```

Related Commands [match metric](#)
[route-map](#)
[show route-maps](#)

set metric-type

Use this command to add a metric-type set clause to a route map entry.

When a route matches the route map entry, the device sets its route type to the specified value.

Use the **no** variant of this command to remove the set clause.

Syntax `set metric-type {type-1|type-2}`
`no set metric-type [type-1|type-2]`

Parameter	Description
type-1	Redistribute matching routes into OSPF as type-1 external routes.
type-2	Redistribute matching routes into OSPF as type-2 external routes.

Mode Route-map Configuration

Usage This command is valid for OSPF routes only.

Example To use entry 3 of the route map called `rmap1` to redistribute matching routes into OSPF as type-1 external routes, use the commands:

```
awplus# configure terminal
awplus(config)# route-map rmap1 permit 3
awplus(config-route-map)# set metric-type 1
```

Related Commands `default-information originate (OSPF)`
`redistribute (OSPF)`
`match route-type`
`route-map`
`show route-map`

set origin

Use this command to add an origin set clause to a route map entry.

When a BGP update message matches the route map entry, the device sets its origin attribute to the specified value.

Use the **no** variant of this command to remove the set clause.

Syntax `set origin {egp|igp|incomplete}`
`no set origin [egp|igp|incomplete]`

Parameter	Description
egp	Learned from an exterior gateway protocol
igp	Learned from a local interior gateway protocol
incomplete	Of unknown heritage, for example a static route

Mode Route-map Configuration

Usage This command is valid for BGP update messages only.

Example To use entry 3 of the route map called `rmap1` to give matching update messages an origin of `egp`, use the commands:

```
awplus# configure terminal
awplus(config)# route-map rmap1 permit 3
awplus(config-route-map)# set origin egp
```

Related Commands [match origin](#)
[route-map](#)
[show route-map](#)

set originator-id

Use this command to add an originator ID set clause to a route map entry.

The originator ID is the router ID of the IBGP peer that first learned this route, either via an EBGP peer or by some other means such as importing it.

When a BGP update message matches the route map entry, the device sets its originator ID attribute to the specified value.

Use the **no** variant of this command to remove the set clause.

Syntax `set originator-id <ip-address>`
`no set originator-id [<ip-address>]`

Parameter	Description
<code><ip-address></code>	The IP address of the originator, entered in the form A.B.C.D.

Mode Route-map Configuration

Usage This command is valid for BGP update messages only.

Example To use entry 3 of the route map called `rmap1` to give matching update messages an originator ID of 1.1.1.1, use the commands:

```
awplus# configure terminal
awplus(config)# route-map rmap1 permit 3
awplus(config-route-map)# set originator-id 1.1.1.1
```

Related Commands `route-map`
`show route-map`

set tag

Use this command to add a tag set clause to a route map entry.

When a route matches the route map entry, the device sets its tag to the specified value when it redistributes the route into OSPF.

Use the **no** variant of this command to remove the set clause.

Syntax `set tag <tag-value>`
`no set tag [<tag-value>]`

Parameter	Description
<code><tag-value></code>	<code><0-4294967295></code> Value to tag matching routes with.

Mode Route-map Configuration

Usage This command is valid only when redistributing routes into OSPF.

Example To use entry 3 of the route map called `rmap1` to tag matching routes with the number 6, use the commands:

```
awplus# configure terminal
awplus(config)# route-map rmap1 permit 3
awplus(config-route-map)# set tag 6
```

Related Commands [default-information originate \(OSPF\)](#)
[redistribute \(OSPF\)](#)
[match tag](#)
[route-map](#)
[show route-map](#)

set weight

Use this command to add a weight set clause to a route map entry.

The weight value assists in best path selection of BGP routes. It is stored with the route in the BGP routing table, but is not advertised to peers. When there are multiple routes with a common destination, the device uses the route with the highest weight value.

When a route matches the route map entry, the device sets its weight to the specified value.

Use the **no** variant of this command to remove the set clause.

Syntax `set weight <weight>`
`no set weight [<weight>]`

Parameter	Description
<code><weight></code>	<code><0-4294967295></code> The weight value.

Mode Route-map Configuration

Usage This command is valid for BGP routes only.

Example To use entry 3 of the route map called `rmap1` to give matching routes a weight of 60, use the commands:

```
awplus# configure terminal
awplus(config)# route-map rmap1 permit 3
awplus(config-route-map)# set weight 60
```

Related Commands `route-map`
`show route-map`

show route-map

Use this command to display information about one or all route maps.

Syntax `show route-map <map-name>`

Parameter	Description
<map-name>	A name to identify the route map

Mode Privileged Exec

Example To display information about the route-map named `example-map`, use the command:

```
awplus# show route-map example-map
```

Output Figure 40-1: Example output from the show route-map command

```
route-map example-map, permit, sequence 1
  Match clauses:
    ip address prefix-list example-pref
  Set clauses:
    metric 100
route-map example-map, permit, sequence 200
  Match clauses:
  Set clauses:
```

Related Commands [route-map](#)

Part 4: Multicast Applications



- Chapter 41 IGMP Snooping Introduction and Configuration
- Chapter 42 IGMP Multicast Commands
- Chapter 43 Common Multicast Commands
- Chapter 44 PIM-SM Configuration
- Chapter 45 PIM-SM Commands
- Chapter 46 PIM-DM Configuration
- Chapter 47 PIM-DM Commands
- Chapter 48 MLD Snooping Commands

Chapter 41: IGMP Snooping Introduction and Configuration



Introduction.....	41.2
Configuring IGMP snooping.....	41.3
Introduction to Query Solicitation.....	41.4
How Query Solicitation Works.....	41.4
Query Solicitation Operation.....	41.5
Speeding up IGMP convergence in a non-looped topology.....	41.6
Enabling Query Solicitation on multiple switches in a looped topology.....	41.7

Introduction

This chapter provides steps to configure Internet Group Management Protocol (IGMP) snooping and an introduction to the Query Solicitation feature when used with IGMP snooping. To see details on the commands used in this example, or to see the outputs of the validation commands, refer to [Chapter 42, IGMP Multicast Commands](#).

Without IGMP snooping, Layer-2 switches handle IP multicast traffic in the same manner as broadcast traffic, and forward multicast frames received on one port to all other ports in the same VLAN. IGMP Snooping allows switches to monitor network traffic, and determine hosts to receive multicast traffic, by looking into IGMP packets to learn which attached hosts need to receive which multicast groups.

This example describes the configuration on an Allied Telesis managed Layer 3 Switch (switch 1). The interface, port1.0.12, is configured as a multicast router port. Host A and Host B are both members of the same multicast group.

To enable IGMP Snooping on an interface:

- Enable IGMP Snooping globally, if necessary.
- Statically configure ports that are connected to routers if necessary.
- By default, IGMP report suppression is enabled on the switch.

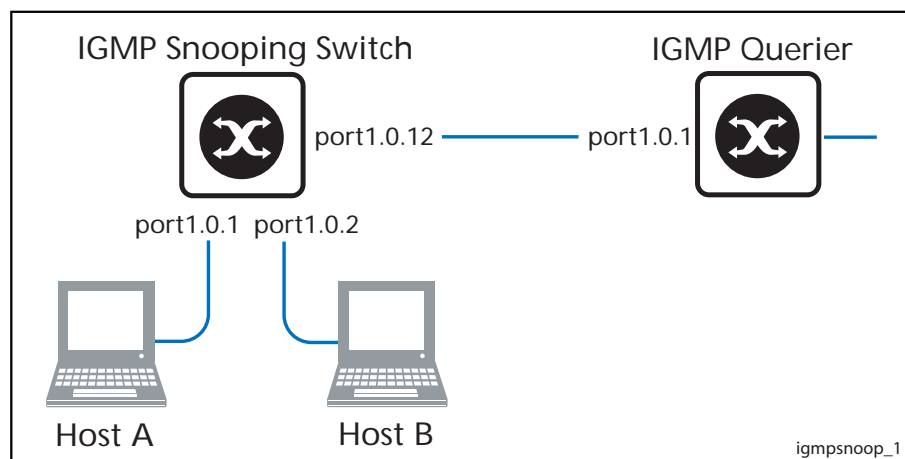

As a result of this configuration:

- Membership reports are generated by hosts. The IGMP Snooping switch will forward the membership reports to its router port. Queries received by the IGMP Snooping switch from the IGMP Querier on port1.0.12 are forwarded by the IGMP Snooping switch.
- Because Host A and Host B are members of the same multicast group, the switch does not notify the IP IGMP routing device (IGMP Querier) when Host A leaves the group, because the group still has another member Host B remaining. When Host B also leaves the group, the switch forwards the leave message to the IP IGMP Querier.
- The addition of a static mrouter port is only required when there is no upstream IGMP querier or an upstream router does not send topology discovery or maintenance messages (like IGMP General Queries or OSPF Hello packets).
- In this example, the configuration of a static mrouter port on port1.0.12 is provided to illustrate the `ip igmp snooping mrouter` command. However, this command would probably not be necessary, since the switch should dynamically set port1.0.12 to be an mrouter port as it receives IGMP Queries arriving from the IGMP Querier attached to port1.0.12.

- In this example, it is not necessary to explicitly configure the switch to work with IGMPv2 or IGMPv3. When the IGMP version is not configured then the switch will work with both versions of IGMP.

Configuring IGMP snooping

In this example when configuring Switch 1, the ports are all part of the same VLAN and IGMP snooping is enabled. This example does not describe how to add the switch ports to a VLAN.

Step 1: Enter the configure mode.

Use the command:

```
awplus# configure terminal
```

Step 2: Enable IGMP snooping.

IGMP snooping is enabled by default. Use the following command only if you have previously disabled it:

```
awplus(config)# ip igmp snooping
```

Step 3: Specify the interface you are configuring.

Specify the interface (vlan1) you are configuring, and enter the Interface mode. Use the command:

```
awplus(config)# interface vlan1
```

Step 4: Configure the multicast router port.

Configure port1.0.12 as a multicast router port to the IGMP Querier. Use the command:

```
awplus(config-if)# ip igmp snooping mrouter interface  
port1.0.12
```

Step 5: Validate the configuration.

Use the following commands to validate the configuration:

```
awplus# show ip igmp interface vlan1
```

```
awplus# show ip igmp groups
```

```
awplus# show ip igmp snooping mrouter vlan1
```

Commands Used

Use the following links to access command descriptions:

- [ip igmp snooping](#)
- [ip igmp snooping mrouter](#)
- [show ip igmp groups](#)
- [show ip igmp interface](#)
- [show ip igmp snooping mrouter](#)

Introduction to Query Solicitation

Query Solicitation minimizes the loss of multicast data after a topology change on networks that use EPSR or spanning tree (STP, RSTP, or MSTP) for loop protection. Without Query Solicitation, when the underlying link layer topology changes, multicast data flow can stop for up to several minutes, depending on which port goes down and how much of the IGMP query interval remained at the time of the topology change. Query Solicitation greatly reduces this disruption.

Query Solicitation operates without configuration in AlliedWare Plus™ switches running STP, RSTP, MSTP or EPSR. However, you may find it useful to manually enable Query Solicitation in loop-free networks running IGMP (see [Speeding up IGMP convergence in a non-looped topology](#)) and networks where not all switches support Query Solicitation (see [Enabling Query Solicitation on multiple switches in a looped topology](#)).

How Query Solicitation Works

Query Solicitation monitors STP, RSTP, MSTP and EPSR messages for topology changes. When it detects a change, it generates a special IGMP Leave message called a Query Solicit. The switch floods the Query Solicit message to all ports in every VLAN that Query Solicitation is enabled on. When the Querier receives the Query Solicit message, it sends out a General Query and waits for clients to respond with Membership Reports. These Reports update the snooping information throughout the network.

Query Solicit messages have a group address of 0.0.0.0.

Query Solicitation works by default (without you enabling it) on all VLANs on the root bridge in an STP instance and on all data VLANs on the master node in an EPSR instance. By default, the root bridge or master node always sends a Query Solicit message when any of the following events occur:

- an STP BPDU packet with the Topology Change (TC) flag arrives at the root bridge
- an STP port on a switch goes from a Discarding to Forwarding state
- the FDB gets flushed by EPSR

If necessary, you can make clients respond more quickly to the General Query by tuning the IGMP timers, especially the maximum response time advertised in IGMP queries using the [ip igmp query-max-response-time](#) command.

Query Solicitation Operation

When IGMP snooping is enabled and EPSR or Spanning Tree changes the underlying link layer topology, this can interrupt multicast data flow for a significant length of time. This is because there is no way for switches in a network with interested clients to know where the traffic is available, due to the change in network topology. This change in network topology may take up to two IGMP Query intervals from the IGMP Querier, until the switches will know where to forward membership reports received by client hosts. During this time, those hosts will not receive multicast traffic.

Query solicitation prevents this by monitoring for any topology changes. When it detects a change, it generates a special IGMP Leave message known as a Query Solicit, and floods the Query Solicit message to all ports in every VLAN that query solicitation is enabled on. When the IGMP Querier receives the message, it responds by sending a General Query, which all IGMP listeners respond to. This refreshes snooped group membership information in the network.

Query solicitation reduces downtime to a negligible amount by triggering on topology changes. The generation of query solicitation messages in the network causes the IGMP Querier to send an IGMP Query immediately following a topology change resulting in the switches knowing where to look for the traffic and thus sending reports to the correct switch upstream, and thus allow the multicast data traffic to be recovered instantly.

Query solicitation functions by default (without you enabling it) on all VLANs on the root bridge in an STP instance and on all data VLANs on the master node in an EPSR instance. By default, the root bridge or master node always sends a Query Solicit message when the topology changes.

If you have multiple STP or EPSR instances, query solicitation only sends Query Solicit messages on VLANs in the instance that experienced a topology change.

In switches other than the STP root bridge or EPSR master node, query solicitation is disabled by default, but you can enable it by using the `ip igmp snooping tcn query solicit` command

If you enable query solicitation on a switch other than the STP root bridge or EPSR master node, both that switch and the root or master send a Query Solicit message.

Once the Querier receives the Query Solicit message, it sends out a General Query and waits for responses, which update the snooping information throughout the network.

The `ip igmp query-holdtime` command can be configured on the IGMP Querier. This command introduces a brief delay between when the IGMP Querier receives the query solicit, and when it sends out the general query. Although this slightly reduces the speed with which the network recovers from the topology change, it does guard against a DoS (Denial of Service) attack. Without this delay, a malign host sending a stream of query solicits could cause the IGMP Querier to flood the network with IGMP Queries.

To get the network to converge faster, use the `ip igmp query-max-response-time` command and set a low response time value, such as one or two seconds, so that the clients will respond immediately with a report as a response to the IGMP Queries

On switches other than the STP root bridge or the EPSR master node, you can disable query solicitation by using the `no` variant of the `ip igmp snooping tcn query solicit` command.

To see whether query solicitation is on or off, check the Query Solicitation field in output of the `show ip igmp interface` command. You can view running and startup configurations with `show running-config` and `show startup-config` commands to see if Query Solicitation is enabled.

The following figure shows how Query Solicitation works when a port goes down:

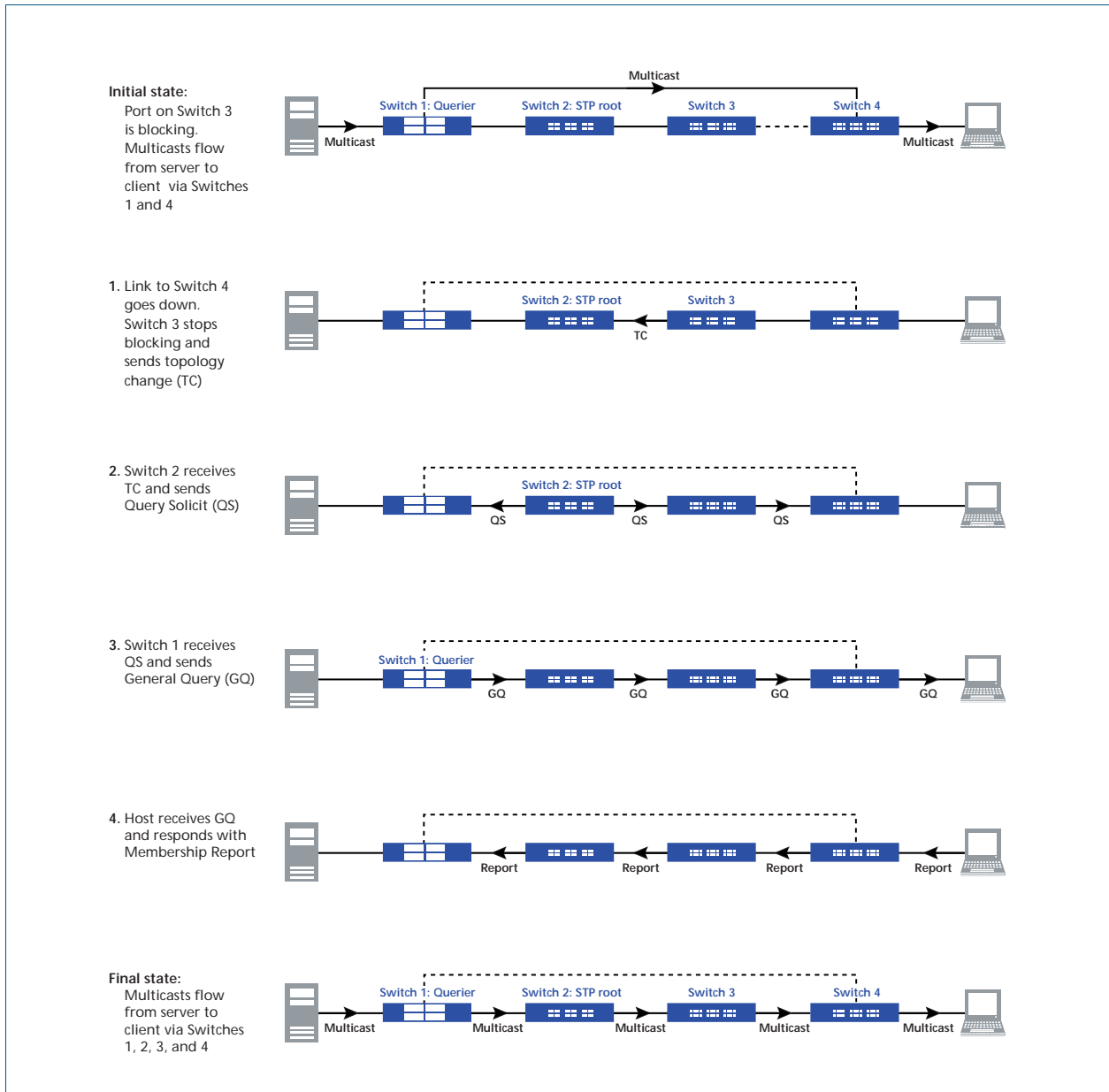

Speeding up IGMP convergence in a non-looped topology

For loop-free networks running IGMP, where it may take up to two minutes for multicasting to recover in a non-looped topology after a port comes back up, you can speed up convergence by enabling RSTP using the `spanning-tree mode` and `spanning-tree enable` commands.

RSTP enables the network to use Query Solicitation by default, and means that multicasting should resume within seconds, not minutes, of the link coming up.

Enabling Query Solicitation on multiple switches in a looped topology

On networks that use spanning tree or EPSR, Query Solicitation is not normally required on switches other than the STP root bridge or EPSR master node. Therefore, it is only enabled by default on the root bridge and the master node.

However, in some networks you may need to turn on Query Solicitation on all switches—for example, if the network includes other switches that do not support Query Solicitation and therefore the STP root bridge may be a switch that does not send Query Solicit messages. To enable Query Solicitation, use the `ip igmp snooping tcn query solicit` command.

Every switch that has Query Solicitation enabled sends a Query Solicit message when it detects a topology change. Enabling it on multiple switches means you get multiple messages, but has no other disadvantage.

The following figure shows a the packet flow for a four-switch network with Query Solicitation enabled on all the switches.

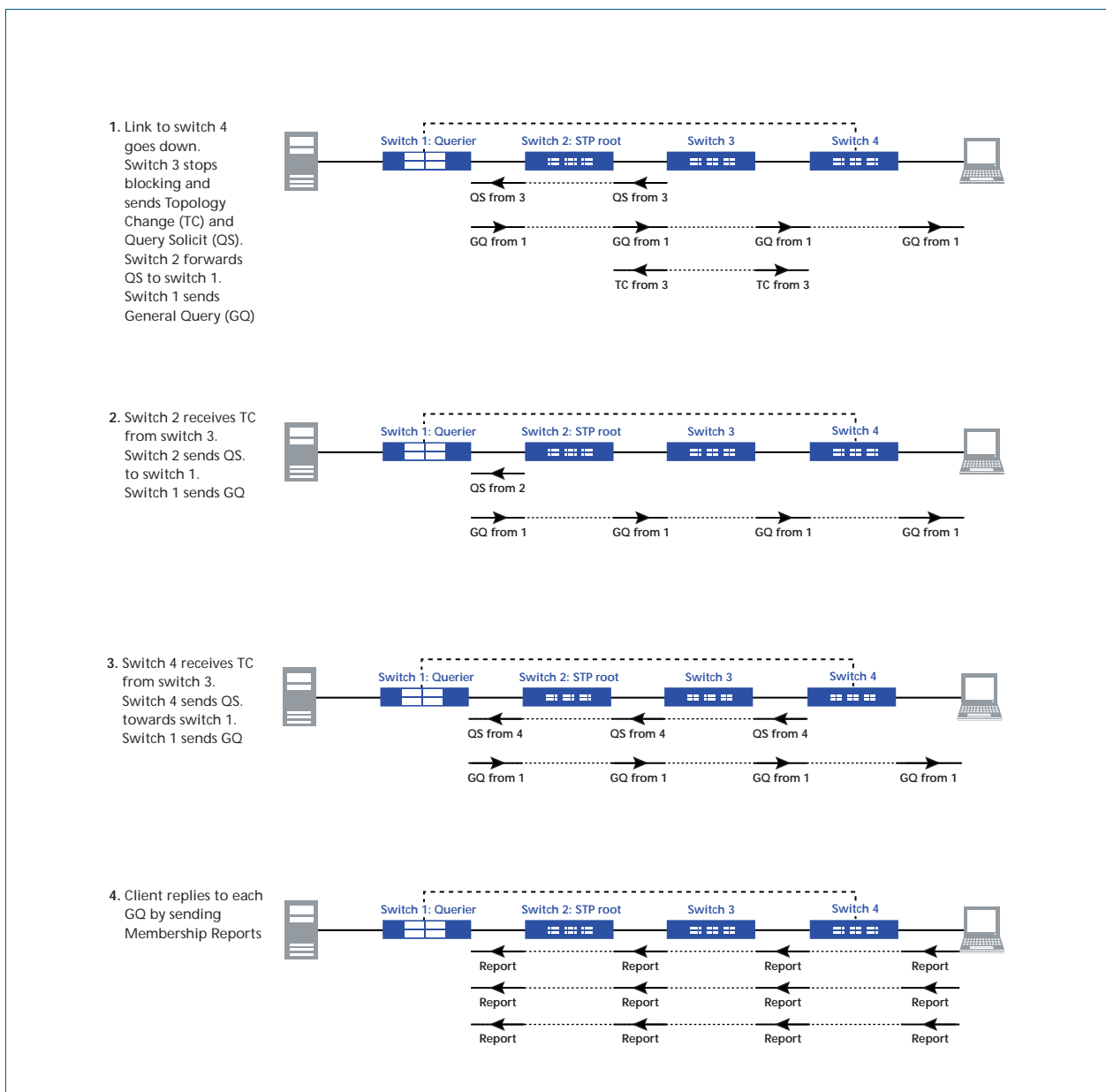

Chapter 42: IGMP Multicast Commands



Introduction.....	42.2
Command List.....	42.2
clear ip igmp.....	42.2
clear ip igmp group.....	42.3
clear ip igmp interface.....	42.4
debug igmp.....	42.5
ip igmp.....	42.6
ip igmp access-group.....	42.7
ip igmp immediate-leave.....	42.8
ip igmp last-member-query-count.....	42.9
ip igmp last-member-query-interval.....	42.10
ip igmp limit.....	42.11
ip igmp mroute-proxy.....	42.12
ip igmp proxy-service.....	42.13
ip igmp querier-timeout.....	42.14
ip igmp query-holdtime.....	42.15
ip igmp query-interval.....	42.17
ip igmp query-max-response-time.....	42.19
ip igmp ra-option (Router Alert).....	42.20
ip igmp robustness-variable.....	42.20
ip igmp snooping.....	42.21
ip igmp snooping fast-leave.....	42.22
ip igmp snooping mrouter.....	42.23
ip igmp snooping querier.....	42.24
ip igmp snooping report-suppression.....	42.25
ip igmp snooping routermode.....	42.26
ip igmp snooping tcn query solicit.....	42.28
ip igmp source-address-check.....	42.29
ip igmp ssm-map enable.....	42.30
ip igmp ssm-map static.....	42.30
ip igmp static-group.....	42.31
ip igmp version.....	42.32
show debugging igmp.....	42.33
show ip igmp groups.....	42.34
show ip igmp interface.....	42.35
show ip igmp snooping mrouter.....	42.38
show ip igmp snooping routermode.....	42.39
show ip igmp snooping statistics.....	42.40
undebug igmp.....	42.40

Introduction

The Internet Group Management Protocol (IGMP) module includes the IGMP Proxy service and IGMP Snooping functionality. Some of the following commands may have commonalities and restrictions: these are described under the Usage section for each command.

Command List

This chapter provides an alphabetical reference of configure, clear, and show commands related to Internet Group Management Protocol (IGMP).

clear ip igmp

Use this command to clear all IGMP group membership records on all VLAN interfaces.

Syntax `clear ip igmp`

Mode Privileged Exec

Usage This command applies to VLAN interfaces configured for IGMP, IGMP Snooping, or IGMP Proxy.

Example

```
awplus# clear ip igmp
```

**Validation
Commands** `show ip igmp interface`
`show running-config`

Related Commands `clear ip igmp group`
`clear ip igmp interface`

clear ip igmp group

Use this command to clear IGMP group membership records for a specific group, on all VLAN interfaces, or for a single VLAN interface, or for a range of VLAN interfaces.

Syntax `clear ip igmp *`
`clear ip igmp group <ip-address> <interface>`

Parameter	Description
*	Clears all groups on all VLAN interfaces. This is an alias to the clear ip igmp command.
<ip-address>	Specifies the group whose membership records will be cleared from all VLAN interfaces, entered in the form A.B.C.D.
<interface>	Specifies the name of the VLAN interface; all groups learned on this VLAN interface are deleted.

Mode Privileged Exec

Usage This command applies to groups learned by IGMP, IGMP Snooping, or IGMP Proxy. In addition to the group, a VLAN interface can be specified. Specifying this will mean that only entries with the group learnt on the interface will be deleted.

Examples

```
awplus# clear ip igmp group *
awplus# clear ip igmp group 224.1.1.1
```

Validation Commands `show ip igmp interface`
`show running-config`

Related Commands `clear ip igmp`
`clear ip igmp interface`

clear ip igmp interface

Use this command to clear IGMP group membership records on a particular VLAN interface.

Syntax `clear ip igmp interface <interface>`

Parameter	Description
<interface>	Specifies the name of the VLAN interface; all groups learned on this VLAN interface are deleted.

Mode Privileged Exec

Usage This command applies to interfaces configured for IGMP, IGMP Snooping, or IGMP Proxy.

Example

```
awplus# clear ip igmp interface vlan1
```

Validation Commands `show ip igmp interface`
`show running-config`

Related Commands `clear ip igmp`
`clear ip igmp group`

debug igmp

Use this command to enable debugging of all IGMP, or a specific component of IGMP.

Use the **no** variant of this command to disable all IGMP debugging, or debugging of a specific component of IGMP.

Syntax `debug igmp {all|decode|encode|events|fsm|tib}`
`no debug igmp {all|decode|encode|events|fsm|tib}`

Parameter	Description
<code>all</code>	enable or disable all debug options for IGMP
<code>decode</code>	debug of IGMP packets that have been received
<code>encode</code>	debug of IGMP packets that have been sent
<code>events</code>	debug IGMP events
<code>fsm</code>	debug IGMP Finite State Machine (FSM)
<code>tib</code>	debug IGMP Tree Information Base (TIB)

Modes Privileged Exec and Global Configuration

Usage This command applies to interfaces configured for IGMP, IGMP Snooping, or IGMP Proxy.

Example

```
awplus# configure terminal
awplus(config)# debug igmp all
```

Related Commands [show debugging igmp](#)
[undebug igmp](#)

ip igmp

Use this command to enable IGMP on an interface. The command configures the device as an IGMP querier.

Use the **no** variant of this command to return all IGMP related configuration to the default on this interface.

Syntax `ip igmp`
`no ip igmp`

Default Disabled

Mode Interface Configuration for a VLAN interface.

Usage This command can only be configured on VLAN interfaces, and will have no effect on IGMP Proxy or IGMP Snooping configuration.

Example

```
awplus# configure terminal
awplus(config)# interface vlan1
awplus(config-if)# ip igmp
```

**Validation
Commands** `show ip igmp interface`
`show running-config`

ip igmp access-group

This command adds an access control list to a VLAN interface configured for IGMP, IGMP Snooping, or IGMP Proxy. The access control list is used to control and filter the multicast groups learnt on the VLAN interface configured for IGMP, IGMP Snooping, or IGMP Proxy.

The **no** variant of this command disables the access control filtering on the interface.

Syntax `ip igmp access-group {<1-99>|<access-list>}`
`no ip igmp access-group`

Parameter	Description
<1-99>	Standard IP access-list number.
<access-list>	Standard IP access-list name.

Default By default there are no access lists configured on any interface.

Mode Interface Configuration for a VLAN interface.

Usage This command applies to VLAN interfaces configured for IGMP, IGMP Snooping, or IGMP Proxy.

Example In the following example, hosts serviced by VLAN 1 can only join the group 225.2.2.2:

```
awplus# configure terminal
awplus(config)# access-list 1 permit 225.2.2.2 0.0.0.0
awplus(config)# interface vlan1
awplus(config-if)# ip igmp access-group 1
```

ip igmp immediate-leave

In IGMP version 2, use this command to minimize the leave latency of IGMP memberships for specified multicast groups.

Use the **no** variant of this command to disable this feature.

Syntax `ip igmp immediate-leave group-list <accesslist>`
`no ip igmp immediate-leave`

Parameter	Description
<accesslist>	<1-99> <1300-1999> <word> Standard access-list name or number that defines multicast groups in which the immediate leave feature is enabled.
<1-99>	Access-list number.
<1300-1999>	Access-list number (expanded range).
<word>	Standard IP access-list name.

Default Disabled by default.

Mode Interface Configuration for a VLAN interface.

Usage This command applies to interfaces configured for IGMP, IGMP Snooping, or IGMP Proxy.

Example The following example shows how to enable the immediate-leave feature on an interface for a specific range of multicast groups

```
awplus# configure terminal
awplus(config)# interface vlan1
awplus(config-if)# ip igmp immediate-leave group-list 34
awplus(config-if)# exit
awplus(config)# access-list 34 permit 225.192.20.0 0.0.0.255
```

Related Commands [ip igmp last-member-query-interval](#)

ip igmp last-member-query-count

Use this command to set the last-member query-count value for an interface.

Use the **no** variant of this command to return to the default value on an interface.

Syntax `ip igmp last-member-query-count <2-7>`
`no ip igmp last-member-query-count`

Parameter	Description
<2-7>	Last member query count value.

Default The default last member query count value is 2.

Mode Interface Configuration for a VLAN interface.

Usage This command applies to interfaces configured for IGMP, IGMP Snooping, or IGMP Proxy.

Example

```
awplus# configure terminal
awplus(config)# interface vlan1
awplus(config-if)# ip igmp last-member-query-count 3
```

Validation Commands `show ip igmp interface`
`show running-config`

ip igmp last-member-query-interval

Use this command to configure the frequency at which the router sends IGMP group-specific host query messages.

Use the **no** variant of this command to set this frequency to the default value.

Syntax `ip igmp last-member-query-interval <interval>`
`no ip igmp last-member-query-interval`

Parameter	Description
<interval>	<1000–25500> Frequency (in milliseconds) at which IGMP group-specific host query messages are sent.

Default 1000 milliseconds

Mode Interface Configuration for a VLAN interface.

Usage This command applies to interfaces configured for IGMP, IGMP Snooping, or IGMP Proxy.

Example The following example changes the IGMP group-specific host query message interval to 2 seconds (2000 milliseconds):

```
awplus# configure terminal
awplus(config)# interface vlan1
awplus(config-if)# ip igmp last-member-query-interval 2000
```

Validation Commands `show ip igmp interface`
`show running-config`

Related Commands `ip igmp immediate-leave`

ip igmp limit

Use this command to configure the limit on the maximum number of group membership entries for the device as a whole or for the specified interface (if in interface mode). Once the specified number of group memberships is reached, all further membership reports will be ignored. Optionally, you can configure an access-list to stop certain address(es) from being subject to the limit.

The limit is dependent on the MTU (Maximum Transmission Unit) of the interface, which is the size in bytes of the largest packet that a network protocol can transmit. Typically for an ethernet channel with an MTU of 1500 the igmp group membership limit will be 183 groups, because each igmp group membership is 8 bytes.

Use the **no** variant of this command to unset the limit and any specified exception access-list.

Syntax `ip igmp limit <limitvalue> [except <accesslist>]`
`no ip igmp limit`

Parameter	Description
<limitvalue>	<2-2097152> Maximum number of group membership entries.
<accesslist>	<1-99> <1300-1999> <word> Number or name of the access list that defines multicast groups that are not subject to the configured limit.
<1-99>	Access-list number
<1300-1999>	Access-list number (expanded range)
<word>	Standard IP access-list name

Default The default limit, which is reset by the **no** variant of this command, is the same as maximum number of group membership entries that can be learned with the **ip igmp limit** command.

The default limit of group membership entries that can be learned is 2095152 entries.

Mode Global Configuration and Interface Configuration for a VLAN interface.

Usage This command applies to interfaces configured for IGMP, IGMP Snooping, or IGMP Proxy.

Example The following example configures an IGMP limit of 100 group membership entries across all interfaces on which IGMP is enabled, and excludes group 224.1.1.1 from this limitation:

```
awplus# configure terminal
awplus(config)# access-list 1 permit 224.1.1.1 0.0.0.0
awplus(config)# ip igmp limit 100 except 1
```

The following example configures an IGMP limit of 100 group membership entries on vlan1:

```
awplus# configure terminal
awplus(config)# interface vlan1
awplus(config-if)# ip igmp limit 100
```

ip igmp mroute-proxy

Use this command to enable IGMP mroute proxy on this downstream interface and associate it with the upstream proxy service interface.

Use the **no** variant of this command to remove the association with the proxy-service interface.

Syntax `ip igmp mroute-proxy <interface>`
`no ip igmp mroute-proxy`

Mode Interface Configuration for a VLAN interface.

Usage You must also enable the IGMP proxy service on the upstream interface, using the [ip igmp proxy-service](#) command. You can associate one or more downstream mroute proxy interfaces on the device with a single upstream proxy service interface. This downstream mroute proxy interface listens for IGMP reports, and forwards them to the upstream IGMP proxy service interface.

IGMP Proxy does not work with other multicast routing protocols, such as PIM-SM or PIM-DM. This command applies to interfaces configured for IGMP Proxy.

Example The following example configures the `vlan1` interface as the upstream proxy-service interface for the downstream interface, `vlan2`.

```
awplus# configure terminal
awplus(config)# interface vlan2
awplus(config-if)# ip igmp mroute-proxy vlan1
```

Related Commands [ip igmp proxy-service](#)

ip igmp proxy-service

Use this command to enable the VLAN interface to be the upstream IGMP proxy-service interface for the device. All associated downstream IGMP mroute proxy interfaces on this device will have their memberships consolidated on this proxy service interface, according to IGMP host-side functionality.

Use the **no** variant of this command to remove the designation of the VLAN interface as an upstream proxy-service interface.

Syntax `ip igmp proxy-service`
`no ip igmp proxy-service`

Mode Interface Configuration for a VLAN interface.

Usage This command is used with the `ip igmp mroute-proxy` command to enable forwarding of IGMP reports to a proxy service interface for all forwarding entries for this interface. You must also enable the downstream IGMP mroute proxy interfaces on this device using the command `ip igmp mroute-proxy`.

IGMP Proxy does not work with other multicast routing protocols, such as PIM-SM or PIM-DM.

Example The following example designates the `vlan1` interface as the upstream proxy-service interface.

```
awplus# configure terminal
awplus(config)# interface vlan1
awplus(config-if)# ip igmp proxy-service
```

Related Commands `ip igmp mroute-proxy`

ip igmp querier-timeout

Use this command to configure the timeout period before the device takes over as the querier for the VLAN interface after the previous querier has stopped querying.

Use the **no** variant of this command to restore the default value.

Syntax `ip igmp querier-timeout <timeout>`
`no ip igmp querier-timeout`

Parameter	Description
<code><timeout></code>	IGMP previous querier timeout interval value in the range <code><1-65535></code> . Number of seconds that the device waits after the previous querier has stopped querying before it takes over as the querier.

Default 255 seconds

Mode Interface Configuration for a VLAN interface.

Usage This command applies to VLAN interfaces configured for IGMP. The timeout value should not be less than the current active querier's general query interval.

Example The following example configures the device to wait 130 seconds from the time it received the last query before it takes over as the querier for the interface:

```
awplus# configure terminal
awplus(config)# interface vlan20
awplus(config-if)# ip igmp querier-timeout 130
```

Validation Commands `show ip igmp interface`
`show running-config`

Related Commands `ip igmp query-interval`

ip igmp query-holdtime

This command sets the time that an IGMP Querier waits after receiving a query solicitation before it sends an IGMP Query. IGMP General Query messages will not be sent during the hold time interval.

Use the **no** variant of this command to return to the default query hold time period.

Syntax `ip igmp query-holdtime <interval>`
`no ip igmp query-holdtime`

Parameter	Description
<interval>	Query interval value (in milliseconds) in the range <100-5000>. Period (in milliseconds) of the delay between receipt of the query solicitation and the sending of the IGMP Query by the IGMP Querier.

Default By default the delay before sending IGMP General Query messages is 500 milliseconds.

Mode Interface Configuration for a VLAN interface.

Usage Use this command to configure a value for the IGMP query hold time in the current network. IGMP Queries can be generated after receiving Query Solicitation (QS) packets and there is a possibility of a DoS (Denial of Service) attack if a stream of Query Solicitation (QS) packets are sent to the IGMP Querier, eliciting a rapid stream of IGMP Queries. This command applies to interfaces on which the switch is acting as an IGMP Querier.

Use the [ip igmp query-interval](#) command when a delay for IGMP general query messages is required and IGMP general query messages are required. The **ip igmp query-holdtime** command stops IGMP query messages during the configured holdtime interval, so the rate of IGMP Queries that can be sent out of an interface can be restricted.

See [“Introduction to Query Solicitation” on page 41.4](#) for introductory information about the Query Solicitation feature.

Examples To set the IGMP query holdtime to 900 ms for `vlan20`, use the following commands:

```
awplus# configure terminal
awplus(config)# interface vlan20
awplus(config-if)# ip igmp query-holdtime 900
```

To reset the IGMP query holdtime to the default (500 ms) for `vlan10`, use the following commands:

```
awplus# configure terminal
awplus(config)# interface vlan10
awplus(config-if)# no ip igmp query-holdtime
```

**Validation
Commands** show ip igmp interface
show running-config

Related Commands ip igmp query-interval
ip igmp snooping tcn query solicit

ip igmp query-interval

Use this command to configure the period for sending IGMP General Query messages. The IGMP query interval specifies the time between IGMP General Query messages being sent.

Use the **no** variant of this command to return to the default query interval period.

Note IGMP query interval must be greater than IGMP query maximum response time.



Syntax `ip igmp query-interval <interval>`
`no ip igmp query-interval`

Parameter	Description
<interval>	Query interval value in the range <2-18000>. Period (in seconds) at which IGMP host query messages are sent.

Default The default IGMP query interval is 125 seconds.

Mode Interface Configuration for a VLAN interface.

Usage This command applies to interfaces configured for IGMP. Note that the IGMP query interval is automatically set to a greater value than the IGMP query max response time.

For example, if you set the IGMP query max response time to 2 seconds using the [ip igmp query-max-response-time](#) command, and the IGMP query interval is currently less than 3 seconds, then the IGMP query interval period will be automatically reconfigured to be 3 seconds, so it is greater than the IGMP query maximum response time.

Use the [ip igmp query-interval](#) command when a non-default interval for IGMP General Query messages is required.

The [ip igmp query-holdtime](#) command can occasionally delay the sending of IGMP Queries.

Example The following example changes the period between IGMP host-query messages to 3 minutes (180 seconds):

```
awplus# configure terminal
awplus(config)# interface vlan20
awplus(config-if)# ip igmp query-interval 180
```

The following example resets the period between sending IGMP host-query messages to the default (125 seconds):

```
awplus# configure terminal
awplus(config)# interface vlan20
awplus(config-if)# no ip igmp query-interval
```

**Validation
Commands** show ip igmp interface
show running-config

Related Commands ip igmp query-holdtime
ip igmp query-max-response-time

ip igmp query-max-response-time

Use this command to configure the maximum response time advertised in IGMP Queries.

Use the **no** variant of this command to restore the default value.

Note  The IGMP query maximum response time must be less than the IGMP query interval.

Syntax

```
ip igmp query-max-response-time <responsetime>
no ip igmp query-max-response-time
```

Parameter	Description
<responsetime>	Response time value in the range <1-3180> Maximum response time (in seconds) advertised in IGMP queries.

Default The default IGMP query maximum response time is 10 seconds.

Mode Interface Configuration for a VLAN interface.

Usage This command applies to interfaces configured for IGMP. Note that the IGMP query interval is automatically set to a greater value than the IGMP query maximum response time.

For example, if you set the IGMP query interval to 3 seconds using the [ip igmp query-interval](#) command, and the current IGMP query interval is less than 3 seconds, then the IGMP query maximum response time will be automatically reconfigured to be 2 seconds, so it is less than the IGMP query interval time.

To get the network to converge faster, use the **ip igmp query-max-response-time** command and set a low response time value, such as one or two seconds, so that the clients will respond immediately with a report as a response to the IGMP Queries

Example The following example configures a maximum response time of 8 seconds:

```
awplus# configure terminal
awplus(config)# interface vlan1
awplus(config-if)# ip igmp query-max-response-time 8
```

The following example restores the default maximum response time of 10 seconds:

```
awplus# configure terminal
awplus(config)# interface vlan1
awplus(config-if)# no ip igmp query-max-response-time
```

Validation Commands [show ip igmp interface](#)
[show running-config](#)

Related Commands [ip igmp query-interval](#)

ip igmp ra-option (Router Alert)

Use this command to enable strict Router Alert (RA) option validation. With strict Router Alert (RA) option enabled, IGMP packets without RA options are ignored.

Use the **no** variant of this command to disable strict Router Alert (RA) option validation.

Syntax `ip igmp ra-option`
`no ip igmp ra-option`

Default The default state of Router Alert (RA) validation is unset.

Mode Interface Configuration for a VLAN interface.

Usage This command applies to interfaces configured for IGMP, and IGMP Snooping.

Example

```
awplus# configure terminal
awplus(config)# interface vlan20
awplus(config-if)# ip igmp ra-option
```

ip igmp robustness-variable

Use this command to change the robustness variable value on a VLAN interface.

Use the **no** variant of this command to return to the default value on an interface.

Syntax `ip igmp robustness-variable <2-7>`
`no ip igmp robustness-variable`

Default The default robustness variable value is 2.

Mode Interface Configuration for a VLAN interface.

Usage This command applies to interfaces configured for IGMP, and IGMP Snooping.

Example

```
awplus# configure terminal
awplus(config)# interface vlan20
awplus(config-if)# ip igmp robustness-variable 3
```

**Validation
Commands** `show ip igmp interface`
`show running-config`

ip igmp snooping

Use this command to enable IGMP Snooping. When this command is used in the Global Configuration mode, IGMP Snooping is enabled at the switch level. When this command is used in Interface Configuration mode, IGMP Snooping is enabled for the specified VLANs.

Use the **no** variant of this command to either globally disable IGMP Snooping, or disable IGMP Snooping on a specified interface.

 **Note** IGMP snooping cannot be disabled on an interface if IGMP snooping has already been disabled globally. IGMP snooping can be disabled on both an interface and globally if disabled on the interface first and then disabled globally.

Syntax `ip igmp snooping`
`no ip igmp snooping`

Default By default, IGMP Snooping is enabled both globally and on all VLANs.

Mode Global Configuration and Interface Configuration for a VLAN interface.

Usage For IGMP snooping to operate on particular VLAN interfaces, it must be enabled both globally by using this command in Global Configuration mode, and on individual VLAN interfaces by using this command in Interface Configuration mode. (Both are enabled by default.)

Examples

```
awplus# configure terminal
awplus(config)# ip igmp snooping
awplus(config)# interface vlan1
awplus(config-if)# ip igmp snooping
```

Related Commands `show ip igmp interface`
`show running-config`

ip igmp snooping fast-leave

Use this command to enable IGMP Snooping fast-leave processing. Fast-leave processing is analogous to immediate-leave processing; the IGMP group-membership entry is removed as soon as an IGMP leave group message is received, without sending out a group-specific query.

Use the **no** variant of this command to disable fast-leave processing.

Syntax `ip igmp snooping fast-leave`
`no ip igmp snooping fast-leave`

Default IGMP Snooping fast-leave processing is disabled.

Mode Interface Configuration for a VLAN interface.

Usage This IGMP Snooping command can only be configured on VLAN interfaces.

Example This example shows how to enable fast-leave processing on a VLAN.

```
awplus# configure terminal
awplus(config)# interface vlan1
awplus(config-if)# ip igmp snooping fast-leave
```

**Validation
Commands** `show ip igmp interface`
`show running-config`

ip igmp snooping mrouter

Use this command to statically configure the specified port in the VLAN as a multicast router port for IGMP Snooping in that VLAN. This command applies to interfaces configured for IGMP Snooping.

Use the **no** variant of this command to remove the static configuration of the port as a multicast router port.

Syntax `ip igmp snooping mrouter interface <port>`
`no ip igmp snooping mrouter interface <port>`

Parameter	Description
<code><port></code>	The port to display information about. The port may be a switch port (e.g. <code>port1.1.4</code>), a static channel group (e.g. <code>sa3</code>), or a dynamic (LACP) channel group (e.g. <code>po4</code>).

Mode Interface Configuration for a VLAN interface.

Usage This IGMP Snooping command can only be configured on VLAN interfaces.

Example This example shows `port1.1.2` statically configured to be a multicast router interface.

```
awplus# configure terminal
awplus(config)# interface vlan1
awplus(config-if)# ip igmp snooping mrouter interface port1.1.2
```

ip igmp snooping querier

Use this command to enable IGMP querier operation on a VLAN when no multicast routing protocol is configured in the VLAN. When enabled, the IGMP Snooping querier sends out periodic IGMP queries for all interfaces on that VLAN. This command applies to interfaces configured for IGMP Snooping.

Use the **no** variant of this command to disable IGMP querier configuration.

Syntax `ip igmp snooping querier`
`no ip igmp snooping querier`

Mode Interface Configuration for a VLAN interface.

Usage This command can only be configured on VLAN interfaces.

The IGMP Snooping querier uses the 0.0.0.0 Source IP address because it only masquerades as a proxy IGMP querier for faster network convergence.

It does not start, or automatically cease, the IGMP Querier operation if it detects query message(s) from a multicast router.

If an IP address is assigned to a VLAN, which has IGMP querier enabled on it, then the IGMP Snooping querier uses the VLAN's IP address as the Source IP Address in IGMP queries.

The IGMP Snooping Querier will not stop sending IGMP Queries if there is another IGMP Snooping Querier in the network with a lower Source IP Address.

Note  Do not enable the IGMP Snooping Querier feature on a L2 switch when there is an operational IGMP Querier in the network.

Example

```
awplus# configure terminal
awplus(config)# interface vlan1
awplus(config-if)# ip igmp snooping querier
```

Validation Commands `show ip igmp interface`
`show running-config`

ip igmp snooping report-suppression

Use this command to enable report suppression for IGMP versions 1 and 2. This command applies to interfaces configured for IGMP Snooping.

Report suppression stops reports being sent to an upstream multicast router port when there are already downstream ports for this group on this interface.

Use the **no** variant of this command to disable report suppression.

Syntax `ip igmp snooping report-suppression`
`no ip igmp snooping report-suppression`

Default Report suppression does not apply to IGMPv3, and is turned on by default for IGMPv1 and IGMPv2 reports.

Mode Interface Configuration for a VLAN interface.

Usage This command can only be configured on VLAN interfaces.

Example This example shows how to enable report suppression for IGMPv2 reports.

```
awplus# configure terminal
awplus(config)# interface vlan1
awplus(config-if)# ip igmp version 2
awplus(config-if)# ip igmp snooping report-suppression
```

**Validation
Commands** `show ip igmp interface`
`show running-config`

ip igmp snooping routermode

Use this command to set source IP addresses as router multicast addresses, according to the routermode (all multicast addresses, default multicast addresses, specified multicast addresses).

Use the **no** variant of this command to reset **ip igmp snooping routermode** to the default. You can also remove a specified IP address from a custom list of multicast addresses.

Syntax `ip igmp snooping routermode {all|default|ip|multicastrouter|address <ip-address>}`

`no ip igmp snooping routermode [address <ip-address>]`

Parameter	Description
<code>no</code>	Negates ip igmp snooping routermode command and resets to its default
<code>all</code>	All reserved multicast addresses (224.0.0.x). Packets from all possible addresses in range 224.0.0.x are set as routers.
<code>default</code>	Default set of reserved multicast addresses. Packets from 224.0.0.1, 224.0.0.2, 224.0.0.4, 224.0.0.5, 224.0.0.6, 224.0.0.9, 224.0.0.13, 224.0.0.15 and 224.0.0.24 are set as routers.
<code>ip</code>	Custom reserved multicast addresses. Custom IP address in the 224.0.0.x range are set as router multicast addresses using the ip igmp snooping routermode address command.
<code>multicastrouter</code>	DVMRP (224.0.0.4) and PIM (224.0.0.13) multicast addresses are set as routers.
<code>address</code>	Specify the multicast address in the 224.0.0.x range for use after issuing an ip igmp snooping routermode ip command
<code><ip-address></code>	IPv4 multicast address (224.0.0.x)

Default The default routermode is **default** not **all** and shows the below reserved multicast addresses:

```
Router mode.....Def
Reserved multicast address
 224.0.0.1
 224.0.0.2
 224.0.0.4
 224.0.0.5
 224.0.0.6
 224.0.0.9
 224.0.0.13
 224.0.0.15
 224.0.0.24
```

Mode Global Configuration

Examples To set `ip igmp snooping routermode` for all default reserved addresses enter:.

```
awplus(config)# ip igmp snooping routermode default
```

To remove the multicast address 224.0.0.5 from the custom list of multicast addresses enter:.

```
awplus(config)# no ip igmp snooping routermode address  
224.0.0.5
```

Related commands `show ip igmp snooping routermode`

ip igmp snooping tcn query solicit

Use this command to enable IGMP (Internet Group Management Protocol) Snooping TCN (Topology Change Notification) Query Solicitation feature globally on all IGMP interfaces from the Global Configuration mode or on VLAN interfaces from the Interface Configuration mode.

Use the **no** variant of this command to disable IGMP Snooping TCN Query Solicitation.

Syntax `ip igmp snooping tcn query solicit`
`no ip igmp snooping tcn query solicit`

Default IGMP Snooping TCN Query Solicitation is disabled by default on the switch, unless the switch is the Master Node in an EPSR ring, or is the Root Bridge in a Spanning Tree.

When the switch is the Master Node in an EPSR ring, or the switch is the Root Bridge in a Spanning Tree, then IGMP Snooping TCN Query Solicitation is enabled by default and cannot be disabled.

Mode Global Configuration or Interface Configuration for a VLAN interface.

Usage Once enabled, if the switch is not an IGMP Querier, on detecting a topology change, the switch generates IGMP Query Solicit messages that are sent to all the ports of the vlan configured for IGMP Snooping on the switch.

On a switch that is not the Master Node in an EPSR ring or the Root Bridge in a Spanning Tree, Query Solicitation can be disabled using the **no** variant of this command after being enabled.

If the switch that detects a topology change is an IGMP Querier then the switch will generate an IGMP Query message.

Note that the **no** variant of this command has no effect on a switch that is the Master Node in an EPSR ring, or a switch that is a Root Bridge in a Spanning Tree, since Query Solicitation cannot be disabled on the Master Node in an EPSR ring or the Root Bridge in a Spanning Tree.

See [“Introduction to Query Solicitation” on page 41.4](#) for introductory information about the Query Solicitation feature.

Examples This example shows how to enable IGMP Snooping TCN Query Solicitation on a switch:

```
awplus# configure terminal
awplus(config)# ip igmp snooping tcn query solicit
```

This example shows how to disable IGMP Snooping TCN Query Solicitation on a switch:

```
awplus# configure terminal
awplus(config)# no ip igmp snooping tcn query solicit
```

Validation Commands `show ip igmp interface`
`show running-config`

Related Commands `ip igmp query-holdtime`

ip igmp source-address-check

This command enables the checking of the Source Address for an IGMP Report, which is the default behavior, rejecting any IGMP Reports originating on devices outside of the local subnet.

Use the **no** variant of this command to disable the checking of the Source Address for an IGMP Report, which allows IGMP Reports from devices outside of the local subnet.

Syntax `ip igmp source-address-check`
`no ip igmp source-address-check`

Parameter	Description
<code>no</code>	Negate a command or set its defaults
<code>ip</code>	Internet Protocol (IP)
<code>igmp</code>	Internet Group Management Protocol (IGMP)
<code>source-address-check</code>	Enable or disable report source address checking for IGMP Reports

Default Source address checking for IGMP Reports is enabled by default.

Mode Interface Configuration for a VLAN interface.

Usage This is a security feature, and should be enabled unless IGMP Reports from outside the local subnet are expected, for example, if Multicast VLAN Registration is active in the network.

The **no** variant of this command is required to disable the IGMP Report source address checking feature in networks that use Multicast VLAN Registration to allow IGMP Reports from devices outside of the local subnet.

Examples To deny IGMP Reports from outside the current subnet, use the following commands:

```
awplus# configure terminal
awplus(config)# interface vlan2
awplus(config-if)# ip igmp source-address-check
```

To allow IGMP Reports from outside the current subnet, use the following commands:

```
awplus# configure terminal
awplus(config)# interface vlan2
awplus(config-if)# no ip igmp source-address-check
```

Validation Commands `show ip igmp interface`
`show running-config`

ip igmp ssm-map enable

Use this command to enable Source Specific Mapping (SSM) on the device.

Use the **no** variant of this command to disable SSM mapping.

Syntax `ip igmp ssm-map enable`
`no ip igmp ssm-map enable`

Mode Global Configuration

Usage This command applies to VLAN interfaces configured for IGMP.

Example This example shows how to configure SSM mapping on the router.

```
awplus# configure terminal
awplus(config)# ip igmp ssm-map enable
```

Related Commands [ip igmp ssm-map static](#)

ip igmp ssm-map static

Use this command to specify the static mode of defining SSM mapping. SSM mapping statically assigns sources to IGMPv1 and IGMPv2 groups to translate such (*,G) groups' memberships to (S,G) memberships for use with PIM-SSM.

Use the **no** variant of this command to remove the SSM map association.

Syntax `ip igmp ssm-map static <access-list> <ip-address>`
`no ip igmp ssm-map static <access-list> <ip-address>`

Parameter	Description
<code><access-list></code>	<1-99> Access-list number
<code><ip-address></code>	Standard IP access-list name, entered in the form A.B.C.D.

Mode Global Configuration

Usage This command applies to VLAN interfaces configured for IGMP.

Example This example shows how to configure an SSM static mapping for group-address 224.1.1.1.

```
awplus# configure terminal
awplus(config)# ip igmp ssm-map static 1 1.2.3.4
awplus(config)# access-list 1 permit 224.1.1.1 0.0.0.0
```

Related Commands [ip igmp ssm-map enable](#)

ip igmp static-group

Use this command to statically configure group membership entries on an interface. To statically add only a group membership, do not specify any parameters.

Use the **no** variant of this command to delete static group membership entries.

Syntax `ip igmp static-group <ip-address> [source {<ip-source-addr>|ssm-map}] [interface <port>]`

`no ip igmp static-group <ip-address> [source {<ip-source-addr>|ssm-map}] [interface <port>]`

Parameter	Description
<code><ip-address></code>	Standard IP Multicast group address, entered in the form A.B.C.D, to be configured as a static group member.
<code>source</code>	Optional.
<code><ip-source-addr></code>	Standard IP source address, entered in the form A.B.C.D, to be configured as a static source from where multicast packets originate.
<code>ssm-map</code>	Mode of defining SSM mapping. SSM mapping statically assigns sources to IGMPv1 and IGMPv2 groups to translate these (*, G) groups' memberships to (S, G) memberships for use with PIM-SSM.
<code>interface</code>	Optional. Use this parameter on VLAN interfaces when static configuration is required for IGMP snooping. If used, static configuration is applied to the port specified in <code><port></code> . If not used, static configuration is applied on all ports in the VLAN.
<code><port></code>	The port to display information about. The port may be a switch port (e.g. <code>port1.1.4</code>), a static channel group (e.g. <code>sa3</code>), or a dynamic (LACP) channel group (e.g. <code>po4</code>).

Mode Interface Configuration for a VLAN interface.

Usage This command applies to IGMP operation on a specific interface to statically add group and/or source records; or to IGMP Snooping on a VLAN interface to statically add group and/or source records.

Example The following example show how to statically add group and source records for IGMP:

```
awplus# configure terminal
awplus(config)# interface vlan3
awplus(config-if)# ip igmp static-group 226.1.2.4 source
10.2.3.4
```

ip igmp version

Use this command to set the current IGMP version (IGMP version 1, 2 or 3) on an interface.

Use the **no** variant of this command to return to the default version.

Syntax `ip igmp version <1-3>`

`no ip igmp version`

Parameter	Description
<1-3>	IGMP protocol version number

Default The default IGMP protocol version number is 3.

Mode Interface Configuration for a VLAN interface.

Usage This command applies to VLAN interfaces configured for IGMP.

Example

```
awplus# configure terminal
awplus(config)# interface vlan5
awplus(config-if)# ip igmp version 2
```

**Validation
Commands** `show ip igmp interface`

show debugging igmp

Use this command to display the IGMP debugging options set.

For information on output options, see [“Controlling “show” Command Output” on page 1.35](#).

Syntax show debugging igmp

Mode Privileged Exec

Example To display the IGMP debugging options set, enter the command:

```
awplus# show debugging igmp
```

Output Figure 42-1: Example output from the **show debugging igmp** command

```
IGMP Debugging status:
  IGMP Decoder debugging is on
  IGMP Encoder debugging is on
  IGMP Events debugging is on
  IGMP FSM debugging is on
  IGMP Tree-Info-Base (TIB) debugging is on
```

Related Commands [debug igmp](#)

show ip igmp groups

Use this command to display the multicast groups with receivers directly connected to the router, and learned through IGMP.

For information on output options, see “Controlling “show” Command Output” on page 1.35.

Syntax `show ip igmp groups [<ip-address>|<interface> detail]`

Parameter	Description
<ip-address>	Address of the multicast group, entered in the form A.B.C.D.
<interface>	Interface name for which to display local information.

Mode User Exec and Privileged Exec

Example The following command displays local-membership information for all ports in all interfaces:

```
awplus# show ip igmp groups
```

Output Figure 42-2: Example output from the `show ip igmp groups` command

IGMP Connected Group Membership					
Group Address	Interface	Uptime	Expires	Last Reporter	
224.0.1.1	port1.1.1	00:00:09	00:04:17	10.10.0.82	
224.0.1.24	port1.1.2	00:00:06	00:04:14	10.10.0.84	
224.0.1.40	port1.1.3	00:00:09	00:04:15	10.10.0.91	
224.0.1.60	port1.1.3	00:00:05	00:04:15	10.10.0.7	
224.100.100.100	port1.1.1	00:00:11	00:04:13	10.10.0.91	
228.5.16.8	port1.1.3	00:00:11	00:04:16	10.10.0.91	
228.81.16.8	port1.1.7	00:00:05	00:04:15	10.10.0.91	
228.249.13.8	port1.1.3	00:00:08	00:04:17	10.10.0.91	
235.80.68.83	port1.1.11	00:00:12	00:04:15	10.10.0.40	
239.255.255.250	port1.1.3	00:00:12	00:04:15	10.10.0.228	
239.255.255.254	port1.1.12	00:00:08	00:04:13	10.10.0.84	

Table 42-1: Parameters in the output of the `show ip igmp groups` command

Parameter	Description
Group Address	Address of the multicast group.
Interface	Port through which the group is reachable.
Uptime	The time in weeks, days, hours, minutes, and seconds that this multicast group has been known to the device.
Expires	Time (in hours, minutes, and seconds) until the entry expires.
Last Reporter	Last host to report being a member of the multicast group.

show ip igmp interface

Use this command to display the state of IGMP, IGMP Proxy service, and IGMP Snooping for a specified VLAN, or all VLANs. IGMP is shown as Active or Disabled in the show output.

For information on output options, see [“Controlling “show” Command Output” on page 1.35.](#)

Syntax show ip igmp interface [*<interface>*]

Parameter	Description
<i><interface></i>	The name of the VLAN interface.

Mode User Exec and Privileged Exec

Example The following output shows IGMP interface status for **vlan2** (with IGMP Snooping enabled):

```
awplus#configure terminal
Enter configuration commands, one per line. End with CNTL/Z.
awplus(config)#interface vlan2
awplus(config-if)#ip igmp snooping
awplus(config-if)#exit
awplus(config)#exit
awplus#show ip igmp interface vlan2
Interface vlan2 (Index 202)
IGMP Disabled, Inactive, Version 3 (default)
IGMP interface has 0 group-record states
IGMP activity: 0 joins, 0 leaves
IGMP robustness variable is 2
IGMP last member query count is 2
IGMP query interval is 125 seconds
IGMP query holdtime is 500 milliseconds
IGMP querier timeout is 255 seconds
IGMP max query response time is 10 seconds
Last member query response interval is 1000 milliseconds
Group Membership interval is 260 seconds
Strict IGMPv3 ToS checking is disabled on this interface
Source Address checking is enabled
IGMP Snooping is globally enabled
IGMP Snooping query solicitation is globally disabled
  Num. query-solicit packets: 57 sent, 0 recvd
IGMP Snooping is enabled on this interface
IGMP Snooping fast-leave is not enabled
IGMP Snooping querier is not enabled
IGMP Snooping report suppression is enabled
awplus#
```

The following output shows IGMP interface status for **vlan2** (with IGMP Snooping disabled):

```
awplus#configure terminal
Enter configuration commands, one per line.  End with CNTL/Z.
awplus(config)#interface vlan2
awplus(config-if)#no ip igmp snooping
awplus(config-if)#exit
awplus(config)#exit
awplus#show ip igmp interface vlan2
Interface vlan2 (Index 202)
  IGMP Disabled, Inactive, Version 3 (default)
  IGMP interface has 0 group-record states
  IGMP activity: 0 joins, 0 leaves
  IGMP robustness variable is 2
  IGMP last member query count is 2
  IGMP query interval is 125 seconds
  IGMP query holdtime is 500 milliseconds
  IGMP querier timeout is 255 seconds
  IGMP max query response time is 10 seconds
  Last member query response interval is 1000 milliseconds
  Group Membership interval is 260 seconds
  Strict IGMPv3 ToS checking is disabled on this interface
  Source Address checking is enabled
  IGMP Snooping is globally enabled
IGMP Snooping query solicitation is globally disabled
  Num. query-solicit packets: 57 sent, 0 recvd
IGMP Snooping is not enabled on this interface
  IGMP Snooping fast-leave is not enabled
  IGMP Snooping querier is not enabled
  IGMP Snooping report suppression is enabled
awplus#
```

The following command displays the IGMP interface status and Query Solicitation for **vlan3**:

```
awplus#show ip igmp interface vlan3
Interface vlan3 (Index 203)
  IGMP Enabled, Active, Querier, Version 3 (default)
  Internet address is 192.168.9.1
  IGMP interface has 256 group-record states
  IGMP activity: 51840 joins, 0 leaves
  IGMP robustness variable is 2
  IGMP last member query count is 2
  IGMP query interval is 125 seconds
  IGMP query holdtime is 500 milliseconds
  IGMP querier timeout is 250 seconds
  IGMP max query response time is 1 seconds
  Last member query response interval is 1000 milliseconds
  Group Membership interval is 251 seconds
  Strict IGMPv3 ToS checking is disabled on this interface
  IGMP Snooping is globally enabled
IGMP Snooping query solicitation is globally enabled
Num. query-solicit packets: 1 sent, 10 recvd
  IGMP Snooping is enabled on this interface
  IGMP Snooping fast-leave is not enabled
  IGMP Snooping querier is not enabled
  IGMP Snooping report suppression is enabled
awplus#
```

Note Query Solicitation status information is highlighted in **bold** in the above output.



Use the **show ip igmp interface** command to validate Query Solicitation is enabled and to show the number of query-solicit message packets sent and received on a vlan.

Related Commands

- clear ip igmp
- clear ip igmp group
- clear ip igmp interface
- ip igmp
- ip igmp last-member-query-count
- ip igmp last-member-query-interval
- ip igmp querier-timeout
- ip igmp query-holdtime
- ip igmp query-interval
- ip igmp query-max-response-time
- ip igmp robustness-variable
- ip igmp snooping
- ip igmp snooping fast-leave
- ip igmp snooping querier
- ip igmp snooping report-suppression
- ip igmp snooping tcn query solicit
- ip igmp version

show ip igmp snooping mrouter

Use this command to display the multicast router ports, both static and dynamic, in a VLAN.

For information on output options, see [“Controlling “show” Command Output” on page 1.35.](#)

Syntax `show ip igmp snooping mrouter interface <interface>`

Parameter	Description
<interface>	The name of the VLAN interface.

Mode User Exec and Privileged Exec

Example The following command displays the multicast router interfaces in v1an1

```
awplus# show ip igmp snooping mrouter interface v1an1
```

Output Figure 42-3: Example output from the `show ip igmp snooping mrouter` command

```
VLAN      Interface
1         port1.1.2
1         port1.1.5
```

show ip igmp snooping routermode

Use this command display the current routermode and the list of IP addresses set as router multicast addresses from the **ip igmp snooping routermode** command.

For information on output options, see [“Controlling “show” Command Output” on page 1.35.](#)

Syntax `show ip igmp snooping routermode`

Mode User Exec and Privileged Exec

Example To show the routermode and the list of router multicast addresses, use the command:

```
awplus# show ip igmp snooping routermode
```

Output Figure 42-4: Example output from the **show ip igmp snooping routermode** command

```
Router mode.....Def
Reserved multicast address
    224.0.0.1
    224.0.0.2
    224.0.0.4
    224.0.0.5
    224.0.0.6
    224.0.0.9
    224.0.0.13
    224.0.0.15
    224.0.0.24
```

Related Commands `ip igmp snooping routermode`

show ip igmp snooping statistics

Use this command to display IGMP Snooping statistics data.

For information on output options, see [“Controlling “show” Command Output” on page 1.35.](#)

Syntax `show ip igmp snooping statistics interface <interface-range>`

Parameter	Description
<code><interface-range></code>	The name of the VLAN interface or interface range.

Mode User Exec and Privileged Exec

Example The following displays IGMP statistical information for `vlan1` and `vlan2`, enter the command:

```
awplus# show ip igmp snooping statistics interface vlan1-vlan2
```

Output [Figure 42-5: Example output from the show ip igmp snooping statistics command](#)

```
IGMP Snooping statistics for vlan1
Interface:      port1.1.3
Group:          224.1.1.1
Uptime:         00:00:09
Group mode:     Exclude (Expires: 00:04:10)
Last reporter: 10.4.4.5
Source list is empty
IGMP Snooping statistics for vlan2
Interface:      port1.1.4
Group:          224.1.1.2
Uptime:         00:00:19
Group mode:     Exclude (Expires: 00:05:10)
Last reporter: 10.4.4.6
Source list is empty
```

undebug igmp

This command applies the functionality of the [no debug igmp command on page 42.5.](#)

Chapter 43: Common Multicast Commands



Command List	43.2
clear ip mroute	43.2
clear ip mroute statistics	43.3
debug nsm mcast	43.3
ip mroute	43.4
ip multicast route-limit	43.5
ip multicast-routing	43.6
multicast	43.7
show ip mroute	43.8
show ip mvif	43.10
show ip rpf	43.11

Command List

This chapter provides an alphabetical reference of multicast commands common to PIM Sparse Mode and PIM Dense Mode. See also [Chapter 42, IGMP Multicast Commands](#), [Chapter 45, PIM-SM Commands](#), [Chapter 47, PIM-DM Commands](#), and [Chapter 48, MLD Snooping Commands](#).

clear ip mroute

Use this command to delete entries from the IP multicast routing table.

Syntax `clear ip mroute {*|<group-addr> [<source-addr>]} [pim sparse-mode]`

Parameter	Description
*	Deletes all multicast routes
<group-addr>	A.B.C.D Group IP address.
<source-addr>	A.B.C.D Source IP address.
pim sparse-mode	Clear specified multicast route(s) for PIM Sparse Mode only.

Mode Privileged Exec

Usage When this command is used, the Multicast Routing Information Base (MRIB) clears the multicast route entries in its multicast route table, and removes the entries from the multicast forwarder. The MRIB sends a "clear" message to the multicast protocols. Each multicast protocol has its own "clear" multicast route command. The protocol-specific "clear" command clears multicast routes from PIM Sparse Mode, and also clears the routes from the MRIB.

Example

```
awplus# clear ip mroute 225.1.1.1 192.168.3.3
```

clear ip mroute statistics

Use this command to delete multicast route statistics entries from the IP multicast routing table.

Syntax `clear ip mroute statistics [*|<group-addr> [<source-addr>]]`

Parameter	Description
*	All multicast route entries.
<group-addr>	A.B.C.D Group IP address.
<source-addr>	A.B.C.D Source IP address.

Mode Privileged Exec

Example

```
awplus# clear ip mroute statistics 225.1.1.2 192.168.4.4
```

debug nsm mcast

Use this command to debug events in the Multicast Routing Information Base (MRIB).

Syntax `debug nsm mcast {all|fib-msg|mrt|mtrace|mtrace-detail|register|stats|vif}`

Parameter	Description
all	All IPv4 multicast debugging.
fib-msg	Forwarding Information Base (FIB) messages.
mrt	Multicast routes.
mtrace	Multicast traceroute.
mtrace-detail	Multicast traceroute detailed debugging.
register	Multicast PIM register messages.
stats	Multicast statistics.
vif	Multicast interface.

Mode Privileged Exec and Global Configuration

Example

```
awplus# configure terminal
awplus(config)# debug nsm mcast register
```

ip mroute

Use this command to create a multicast static route.

Use the **no** variant of this command to delete the route.

Multicast static routes are unicast routes which allow multicast and unicast topologies to be independent. These routes are used by multicast routing protocols to perform reverse-path forwarding (RPF) checks.

Syntax `ip mroute <source-addr/mask-length> [bgp|ospf|rip|static] <rpf-addr> [<distance>]`

`no ip mroute <source-addr/mask-length> [bgp|ospf|rip|static]`

Parameter	Description
<code><source-addr/mask-length></code>	A.B.C.D/0-32 Specifies multicast source IP address and mask length.
<code>bgp</code>	BGP unicast routing protocol
<code>ospf</code>	OSPF unicast routing protocol
<code>rip</code>	RIP unicast routing protocol
<code>static</code>	specifies a static route
<code><rpf-addr></code>	A.B.C.D RPF address for the multicast route. The host IP address can be a directly connected system or a remote system. When it is a remote system, a lookup is done from the unicast routing table to find a directly connected system.
<code><distance></code>	The administrative distance. Use this to determine whether the RPF lookup selects the unicast or multicast route. Lower distances have preference. If the multicast static route has the same distance as the other RPF sources, the multicast static route takes precedence. Default is 0. Range is 0-255.

Mode Global Configuration

Examples The following example configures the 10.10.3.0 network address with a static multicast route to 192.168.2.2 with an administrative distance of 2:

```
awplus# configure terminal
awplus(config)# ip mroute 10.10.3.0/24 static 2 192.168.2.2
```

The following example configures all specific sources within a network number to be accessible through 10.10.10.50:

```
awplus# configure terminal
awplus(config)# ip mroute 192.168.3.0/24 10.10.10.50
```

Validation Commands `show ip rpf`

ip multicast route-limit

Use this command to limit the number of multicast routes that can be added to a multicast routing table.

Use the **no** variant of this command to return the limit to the default.

Syntax `ip multicast route-limit <limit> [<threshold>]`
`no ip multicast route-limit`

Parameter	Description
<code><limit></code>	<code><1-2147483647></code> Number of routes.
<code><threshold></code>	<code><1-2147483647></code> Threshold above which to generate a warning message. The mroute warning threshold must not exceed the mroute limit.

Default The default limit and threshold value is 2147483647.

Mode Global Configuration

Usage This command limits the number of multicast routes (mroutes) that can be added to a router, and generates an error message when the limit is exceeded. If the threshold parameter is set, a threshold warning message is generated when this threshold is exceeded, and the message continues to occur until the number of mroutes reaches the limit set by the limit argument.

Example

```
awplus# configure terminal
awplus(config)# ip multicast route-limit 34 24
```

ip multicast-routing

Use this command to turn on/off multicast routing on the router; when turned off the device does not perform multicast functions.

Use the **no** variant of this command to disable multicast routing after enabling it. Note the default stated below.

Syntax `ip multicast-routing`
`no ip multicast-routing`

Default By default, multicast routing is off.

Mode Global Configuration

Usage When the **no** variant of this command is used, the Multicast Routing Information Base (MRIB) cleans up Multicast Routing Tables (MRT), stops IGMP operation, and stops relaying multicast forwarder events to multicast protocols.

When multicast routing is enabled, the MRIB starts processing any MRT addition/deletion requests, and any multicast forwarding events.

You must enable multicast routing before issuing other multicast commands.

Example

```
awplus# configure terminal
awplus(config)# ip multicast-routing
```

**Validation
Commands** `show running-config`

multicast

Use this command to enable a switch port to route multicast packets that ingress the port.

Use the **no** variant of this command to stop the switch port from routing multicast packets that ingress the port. Note that this does not affect layer 2 forwarding of multicast packets. If you enter **no multicast** on a port, multicast packets received on that port will not be forwarded to other VLANs, but ports in the same VLANs as the receiving port will still receive the multicast packets.

Syntax `multicast`
`no multicast`

Default By default, all switch ports route multicast packets.

Mode Interface mode

Examples

```
awplus# configure terminal
awplus(config)# interface port1.0.1
awplus(config-if)# multicast
```

```
awplus# configure terminal
awplus(config)# interface port1.0.1
awplus(config-if)# no multicast
```

Validation Commands `show running-config`

show ip mroute

Use this command to display the contents of the IP multicast routing (mroute) table.

Syntax `show ip mroute [<group-addr>] [<source-addr>] [{dense|sparse}]`
 `[count|summary]`

Parameter	Description
<code><group-addr></code>	Group IP address.
<code><source-addr></code>	Source IP address.
<code>dense</code>	Display dense multicast routes.
<code>sparse</code>	Display sparse multicast routes.
<code>count</code>	Display the route and packet count from the IP multicast routing (mroute) table.
<code>summary</code>	Display the contents of the IP multicast routing (mroute) table in an abbreviated form.

Mode User Exec and Privileged Exec

Examples

```
awplus# show ip mroute 10.10.3.34 224.1.4.3
```

```
awplus# show ip mroute 10.10.5.24 225.2.2.2 count
```

```
awplus# show ip mroute 10.10.1.34 summary
```

Output The following is a sample output of this command displaying the IP multicast routing table, with and without specifying the group and source IP address:

```
awplus# show ip mroute
IP Multicast Routing Table
Flags: I - Immediate Stat, T - Timed Stat, F - Forwarder
installed
Timers: Uptime/Stat Expiry
Interface State: Interface (TTL)

(10.10.1.52, 224.0.1.3), uptime 00:00:31, stat expires 00:02:59
Owner PIM-SM, Flags: TF
  Incoming interface: vlan2
  Outgoing interface list:
    vlan3 (1)
```



```
awplus# show ip mroute 10.10.1.52 224.0.1.3

IP Multicast Routing Table
Flags: I - Immediate Stat, T - Timed Stat, F - Forwarder installed
Timers: Uptime/Stat Expiry
Interface State: Interface (TTL)

(10.10.1.52, 224.0.1.3), uptime 00:03:24, stat expires 00:01:28
Owner PIM-SM, Flags: TF
  Incoming interface: vlan2
  Outgoing interface list:
    vlan3 (1)
```

The following is a sample output of this command displaying the packet count from the IP multicast routing table:

```
awplus# show ip mroute count

IP Multicast Statistics
Total 1 routes using 132 bytes memory
Route limit/Route threshold: 2147483647/2147483647
Total NOCACHE/WRONGVIF/WHOLEPKT rcv from fwd: 1/0/0
Total NOCACHE/WRONGVIF/WHOLEPKT sent to clients: 1/0/0
Immediate/Timed stat updates sent to clients: 0/0
Reg ACK rcv/Reg NACK rcv/Reg pkt sent: 0/0/0
Next stats poll: 00:01:10

Forwarding Counts: Pkt count/Byte count, Other Counts: Wrong If
pkts
Fwd msg counts: WRONGVIF/WHOLEPKT rcv
Client msg counts: WRONGVIF/WHOLEPKT/Imm Stat/Timed Stat sent
Reg pkt counts: Reg ACK rcv/Reg NACK rcv/Reg pkt sent

(10.10.1.52, 224.0.1.3), Forwarding: 2/19456, Other: 0
  Fwd msg: 0/0, Client msg: 0/0/0/0, Reg: 0/0/0
```

The following is a sample output for this command displaying the IP multicast routing table in an abbreviated form:

```
awplus# show ip mroute summary

IP Multicast Routing Table
Flags: I - Immediate Stat, T - Timed Stat, F - Forwarder installed
Timers: Uptime/Stat Expiry
Interface State: Interface (TTL)

(10.10.1.52, 224.0.1.3), 00:01:32/00:03:20, PIM-SM, Flags: TF
```

show ip mvif

Use this command to display the contents of the Multicast Routing Information Base (MRIB) VIF table.

Syntax `show ip mvif [<interface>]`

Parameter	Description
<interface>	The interface to display information about.

Mode User Exec and Privileged Exec

Example

```
awplus# show ip mvif vlan2
```

Output Figure 43-1: Example output from the `show ip mvif` command

Interface	Vif Idx	Owner Module	TTL	Local Address	Remote Address	Uptime
vlan2	0	PIM-SM	1	192.168.1.53	0.0.0.0	00:04:26
Register	1		1	192.168.1.53	0.0.0.0	00:04:26
vlan3	2	PIM-SM	1	192.168.10.53	0.0.0.0	00:04:25

Figure 43-2: Example output from the `show ip mvif` command with the interface parameter `vlan2` specified

Interface	Vif Idx	Owner Module	TTL	Local Address	Remote Address	Uptime
vlan2	0	PIM-SM	1	192.168.1.53	0.0.0.0	00:05:17

show ip rpf

Use this command to display Reverse Path Forwarding (RPF) information for the specified source address.

Syntax `show ip rpf <source-addr>`

Parameter	Description
<code><source-addr></code>	A.B.C.D Specifies source IP address

Mode User Exec and Privileged Exec

Example

```
awplus# show ip rpf 10.10.10.50
```



Chapter 44: PIM-SM Configuration



Introduction.....	44.2
Characteristics of PIM-SM.....	44.2
Roles in PIM-SM.....	44.3
Operation of PIM-SM.....	44.4
PIM-SM Configuration.....	44.6
Static Rendezvous Point configuration.....	44.7
Dynamic Rendezvous Point configuration.....	44.9
Bootstrap Router configuration.....	44.11

Introduction

Protocol Independent Multicast - Sparse Mode (PIM-SM) provides efficient communication between members of sparsely distributed groups - the type of groups that are most common in wide-area internetworks.

 **Note** The Bootstrap Router (BSR) function will not work properly if there are PIM-SM routers using VRRP.

For details of the commands used to configure PIM-DM, see [Chapter 45, PIM-SM Commands](#).

Characteristics of PIM-SM

PIM Sparse Mode (PIM-SM) is designed on the principle that several hosts wishing to participate in a multicast conference does not justify flooding the entire internetwork with periodic multicast traffic. PIM-SM is designed to limit multicast traffic so that only those switches interested in receiving traffic for a particular group receive the traffic.

Switches with directly attached or downstream members are required to join a Sparse Mode distribution tree by transmitting explicit join messages. If a switch does not become part of the predefined distribution tree, it does not receive multicast traffic addressed to the group. In contrast, dense mode multicast routing protocols assume downstream group membership and continue to forward multicast traffic on downstream links until explicit prune messages are received. The default forwarding action of a sparse mode multicast routing protocol is to block traffic unless it is explicitly requested, while the default action of the dense mode multicast routing protocols is to forward traffic.

PIM-SM employs the concept of a Rendezvous Point (RP) where receivers “meet” sources. The initiator of each multicast group selects a primary RP and a small ordered set of alternative RPs, known as the RP-list. For each multicast group, there is only a single active RP. Each receiver wishing to join a multicast group contacts its directly attached switch, which in turn joins the multicast distribution tree by sending an explicit join message to the group's primary RP. A source uses the RP to announce its presence and to find a path to members that have joined the group. This model requires Sparse Mode switches to maintain some state information (the RP-list) prior to the arrival of data packets. In contrast, Dense Mode multicast routing protocols are data driven, since they do not define any state for a multicast group until the first data packet arrives.

Roles in PIM-SM

A multicast sender does not need to know the addresses of the members of the group in order to send to them, and the members of the group need not know the address of the sender. Group membership can change at any time. When PIM is enabled on the switch, and before the switch can route multicast traffic, it must establish which of the PIM routers in the network are performing some key roles:

- Designated Router.
- Rendezvous Point.
- Bootstrap Router.

Designated Router

There must be one PIM Designated Router (DR) in the subnetwork to which the IP hosts are connected. Any PIM-SM interfaces on the subnetwork elect the DR with the highest DR priority. If there is more than one router with the same priority, or no priority, they choose the interface with the highest IP address number. The DR performs all the PIM functionality for the subnetwork. If the current DR becomes unavailable, the remaining switches elect a new DR on the interface by DR priority or IP address.

Rendezvous Point

Each multicast group must have a Rendezvous Point (RP). The RP forms the root of the group's distribution tree. The DR for a multicast sender sends multicast packets towards the RP. DRs with group members connected to them send join messages towards the group's RP. The RP candidate with the lowest priority is elected from all the RP candidates for a group. If the RP becomes unavailable, the remaining RP candidates elect a new RP.

Bootstrap Router

Each PIM-SM network must have at least one Bootstrap Router (BSR) candidate, unless all switches in the domain are configured statically with information about all RPs in the domain. Every switch that is a BSR candidate periodically sends a Bootstrap Candidate Advertisement message to advertise that it is available as a BSR candidate. The BSR candidates in the network elect the switches with the highest preference value to be the BSR. The elected BSR listens to PIM Candidate RP Advertisement messages specifying RP candidates for multicast groups. It maintains a list of RP candidates and sends a bootstrap message every BSM interval, specifying all the multicast groups in the PIM network, and their RP candidates. Each switch uses this information and a standardized hash mechanism to determine the RP for each group.

In summary:

- Each multicast group must have at least one RP candidate
- Each PIM-SM domain must have at least one BSR candidate, unless all routers in the domain are configured statically with information about all RPs in the domain
- Each subnetwork must have at least one DR candidate.

Note The BSR function will not work properly if there are PIM-SM routers using VRRP.



PIM hello messages

When PIM is enabled on a switch, it sends out a PIM Hello message on all its PIM enabled interfaces, and listens for Hello messages from its PIM neighbors. When a switch receives a Hello message, it records the interface, IP address, priority for becoming a DR, and the timeout for the neighbor's information. The switch sends Hello messages regularly at the Hello Time interval.

Operation of PIM-SM

Once roles are established, multicast routing follows specific phases:

1. [Rendezvous Point Tree](#)
2. [Register stop](#)
3. [Shortest Path Tree](#)

While multicast routing always begins with phase 1, the Designated Router (DR) for a receiver determines whether and when to move on to phases 2 and 3, depending on the amount of traffic from the source.

Rendezvous Point Tree

Phase 1 establishes and uses a shared tree rooted at the Rendezvous Point (RP) to forward all multicast data to group members.

When an IP host sends an IGMP join message to the local PIM DR, which is not the RP for the group, the DR sends a PIM join message towards the RP for the group ("upstream"). The DR determines which switch is the RP for the group from the most recent bootstrap message. Every switch the join message passes through records that there is a group member on the incoming interface. Eventually, the join message reaches either the RP, or another switch that already knows that it has a group member downstream. If the group has many members, the join messages converge on the RP to form a Rendezvous Point Tree (RPT). This is called a shared tree because multicast data that is sent to the group by any sender shares the tree. The multicast receiver's DR sends join messages periodically according to the upstream join timer as long as the IP host is a member of the group. When the last receiver on a subnetwork leaves the group, the join messages stop, and their entries timeout on routers that are closer to the RP.

The sender's DR encapsulates the multicast data in a unicast packet in a process called **registering**, and sends these register packets to the group's RP. When the RP receives the data, it decapsulates them, and forwards them onto the shared tree.

Register stop

Phase 2 improves efficiency and performance by using register stop. In this phase the RP joins the shortest path tree between the source and receiver. This allows the original (unencapsulated) packets to be forwarded from the sender, instead of encapsulated packets. It also allows shorter paths to receivers that are close to the sender, making it more efficient in some circumstances.

When the RP for a group receives the first encapsulated data packet from a source, it joins the shortest path tree towards the sender. Once data is able to flow along the shortest path from the sender to the RP, packets do not need to be registered. The RP sends a register stop message in reply to the next encapsulated message. When the sender's DR receives the register stop message, it stops registering. The DR sends a null register message to the RP to find whether the RP still does not need to receive registered packets. If it receives another register stop message, the DR continues to forward only the native data packets. If the DR does not receive another register stop message within the register probe time, it resumes registering the data packets and sending them to the RP.

When the RP starts receiving native data packets from the source, it starts to discard the encapsulated packets, and starts forwarding native packets on the shared tree to all the group members. If the path from the source to the RP intersects the shared RP tree for the group, then the packets also take a short-cut onto the shared tree for delivery to the group members down its branches.

Shortest Path Tree This phase further optimizes routing by using Shortest Path Trees (SPT). In phase 3 the receiver joins the shortest path tree between the source and receiver. This allows a multicast group member to receive multicast data by the shortest path from the sender, instead of from the shared RP tree. When the receiver's DR receives multicast data from a particular sender, it sends a join message towards the sender. When this message reaches the sender's DR, the DR starts forwarding the multicast data directly towards the receiver. As several receivers all initiate shortest paths to the sender, these paths converge, creating a SPT.

When the multicast packets start arriving from the SPT at the receiver's DR or an upstream router common to the SPT and the RPT, it starts discarding the packets from the RPT, and sends a prune message towards the RP. The prune message travels up the RPT until it reaches the RP or a switch that still needs to forward multicast packets from this sender to other receivers. Every time a switch receives a prune message, it waits a short time so that other switches on the LAN have the opportunity to override the prune message.

Multi-Access LANs If the PIM-SM network includes multi-access LAN links for transit, as well as point-to-point links, then a mechanism is needed to prevent multiple trees forwarding the same data to the same group member. Two or more switches on a LAN may have different information about how to reach the RP or the multicast sender. They could each send a join message to two different switches closer to the RP for an RPT or the sender for an SPT. This could potentially cause two copies of all the multicast traffic towards the receiver.

When PIM switches notice duplicate data packets on the LAN, they elect a single switch to forward the data packets, by each sending PIM Assert messages. If one of the upstream switches is on an SPT and the other is on an RPT, the switch on the SPT has the shortest path to the sender, and wins the Assert election. If both switches are on RPTs the switch with the shortest path to the RP (the lowest sum of metrics to the RP) wins the Assert. If both switches are on an SPT, then the switch with the shortest path to the sender (the lowest sum of metrics to the sender's DR) wins the Assert.

The switch that won the Assert election forwards these data packets, and acts as the local Designated Router for any IGMP members on the LAN. The downstream switches on the LAN also receive the Assert messages, and send all their join messages to the Assert winner. The result of an Assert election will timeout after the Assert Time. As long as the situation causing the duplication remains unchanged, the Assert winner sends an Assert message at a the Assert time interval, before the previous Assert messages time out. When the last downstream switch leaves the SPT, the Assert winner sends an Assert Cancel message saying that it is about to stop forwarding data on the SPT. Any RPT downstream switches then switch back to the RP tree.

PIM-SM Configuration

This section provides three PIM-SM configuration examples:

- Static Rendezvous Point configuration
- Dynamic Rendezvous Point configuration
- Bootstrap Router configuration

Both Rendezvous Point (RP) configuration examples refer to the network topology in the following graphic and use Allied Telesis managed Layer 3 Switches as the PIM routers. For details on the commands used in the following examples, refer to [Chapter 45, PIM-SM Commands](#).

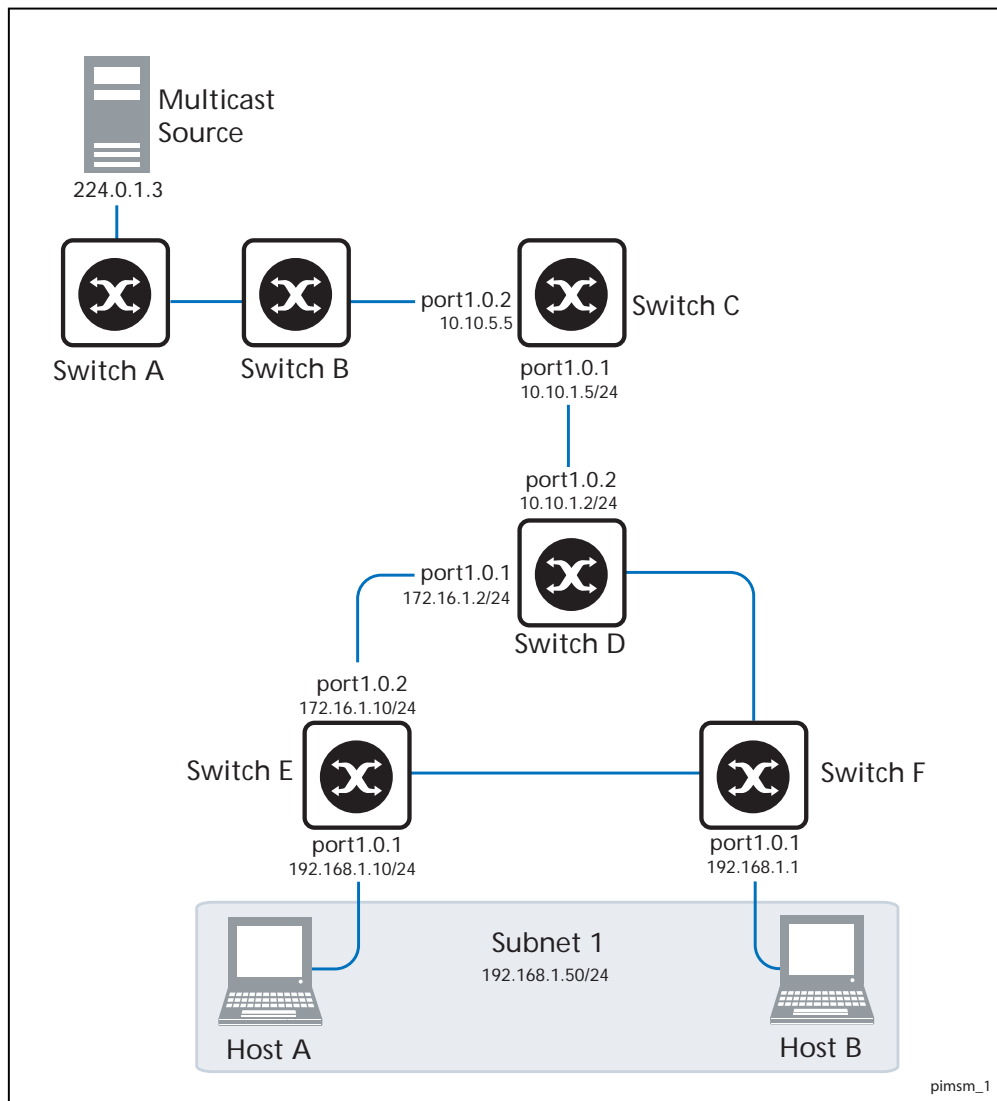

Static Rendezvous Point configuration

In this example using the above network topology, Switch C is the Rendezvous Point (RP) and all switches are statically configured with RP information. Host A and Host B join group 224.0.1.3 for all the sources. They send the IGMP membership report to Subnet 1. Two switches are attached to Subnet 1, Switch E and Switch F. Both of these switches have default Designated Router (DR) priority on port1.0.1. Because Switch E has a higher IP address on port1.0.1, Switch E becomes the DR and is responsible for sending Join messages to the RP (Switch C).

While configuring the RP, ensure that:

- Every switch includes the `ip pim rp-address 10.10.1.5` statement, even if it does not have any source or group member attached to it.
- There is only one RP address for the whole multicast group.
- All interfaces running PIM-SM must have sparse-mode enabled. In the configuration sample output below, both `port1.0.1` and `port1.0.2` are pim sparse-mode enabled.

See the following configuration output for Switch D:

```
hostname Switch D
!
interface port1.0.0
!
interface port1.0.1
 ip pim sparse-mode
!
interface port1.0.2
 ip pim sparse-mode
!
interface lo
!
!
ip multicast-routing
ip pim rp-address 10.10.1.5
!
```

Configure all the switches with the same `ip pim rp-address 10.10.1.5` statement as shown above.

Verifying configuration

Use the following commands to verify the RP configuration, interface details, and the multicast routing table.

RP details For Switch D, the `show ip pim sparse-mode rp mapping` command shows that 10.10.1.5 is the RP for all multicast groups 224.0.0.0/4, and is statically configured. All other switches will have a similar output.

```
awplus#show ip pim sparse-mode rp mapping
PIM Group-to-RP Mappings
Group(s): 224.0.0.0/4, Static
RP: 10.10.1.5
Uptime: 5d02h15m
```

For Switch D, the `show ip pim sparse-mode rp-hash` command displays the selected RP for the specified group, in this example 224.0.1.3.

```
awplus#show ip pim sparse-mode rp-hash 224.0.1.3
RP: 10.10.1.5
```

Interface details

For Switch E, the `show ip pim sparse-mode interface` command displays the interface details and shows that Switch E is the DR on Subnet 1.

```
awplus#show ip pim sparse-mode interface
Total configured interfaces: 16   Maximum allowed: 31
Total active interfaces:      12

Address          Interface VIFindex Ver/   Nbr    DR    DR
                port1.0.1 0       v2/S  Count Prior
192.168.1.10    port1.0.1 0       v2/S  1      1
192.168.1.10
172.16.1.10     port1.0.2 2       v2/S  1      1
172.16.1.10
```

In this example Switch E has a base license. With the base license, the maximum number of PIM-SM interfaces that can be configured is 31. With a feature license a maximum of 100 PIM-SM interfaces are available.

IP multicast routing table

Note that the multicast routing table displayed for an RP switch is different to that displayed for other switches. For Switch C, because this switch is the RP and the root of this multicast tree, the `show ip pim sparse-mode mroute` command shows `RPF nbr` (next-hop to reach RP) as 0.0.0.0 and `RPF idx` (incoming interface for this (*, G) state) as `None`.

```
awplus#show ip pim sparse-mode mroute
IP Multicast Routing Table

(*,*,RP) Entries: 0
(*,G) Entries: 1
(S,G) Entries: 0
(S,G,rpt) Entries: 0
(*, 224.0.1.3)
RP: 10.10.1.5
RPF nbr: 0.0.0.0
RPF idx: None
Upstream State: JOINED
Local      .....
Joined     j.....
Asserted   .....
Outgoing   o.....
```

For Switch E, the `show ip pim sparse-mode mroute` command displays the IP multicast routing table.

```
awplus#show ip pim sparse-mode mroute
IP Multicast Routing Table

(*,*,RP) Entries: 0
(*,G) Entries: 1
(S,G) Entries: 0
(S,G,rpt) Entries: 0
(*, 224.0.1.3)
RP: 10.10.1.5
RPF nbr: 172.16.1.2
RPF idx: port1.0.2
Upstream State: JOINED
Local      .....
Joined     j.....
Asserted   .....
Outgoing   o.....
```

On Switch E, `port1.0.2` is the incoming interface of the `(*, G)` entry, and `port1.0.1` is on the outgoing interface list of the `(*, G)` entry. This means that there is a group member through `port1.0.1`, and RP is reachable through `port1.0.2`.

Dynamic Rendezvous Point configuration

A static RP configuration works for a small, stable PIM domain. However, it is not practical for a large and not so stable internetwork. In such a network, if the RP fails, the network administrator may have to change the static configurations on all PIM switches. An additional reason for choosing dynamic configuration high routing traffic leading to a change in the RP.

The Bootstrap Router (BSR) mechanism is used to dynamically maintain the RP information. To configure the RP dynamically in the above network topology, Switch C on `port1.0.1` and Switch D on `port1.0.1` are configured as RP candidates using the `ip pim rp-candidate` command. Switch D on `port1.0.1` is also configured as the BSR candidate. Since no other device has been configured as a BSR candidate, Switch D becomes the BSR router and is responsible for sending group-to-RP mapping information to all other PIM switches in this PIM domain.

The following output displays the complete configuration at **Switch C**.

```
awplus#show run
interface port1.0.0
!
interface port1.0.1
 ip pim sparse-mode
!
interface port1.0.2
 ip pim sparse-mode
!
interface lo
!
ip multicast-routing
ip pim rp-candidate port1.0.1
```

The following output displays the complete configuration at Switch D.

```
awplus#show run
interface port1.0.0
!
interface port1.0.1
 ip pim sparse-mode
!
interface port1.0.2
 ip pim sparse-mode
!
interface lo
!
ip multicast-routing
ip pim bsr-candidate port1.0.1
ip pim rp-candidate port1.0.1 priority 2
!
```

The highest priority switch is chosen as the RP. If two or more switches have the same priority, a hash function in the BSR mechanism is used to choose the RP to make sure that all devices in the PIM domain have the same RP for the same multicast group.

Use the `<interface> [priority <priority>]` parameters of the `ip pim rp-candidate` command to change the default priority of any RP candidate.

PIM group-to-RP mappings

The `show ip pim sparse-mode rp mapping` command displays the group-to-RP mapping details. The output shows information about RP candidates. There are two RP candidates for the group range `224.0.0.0/4`. RP candidate `10.10.1.5` has a default priority of 192, whereas RP candidate `172.16.1.2` has been configured to have a priority of 2. Since RP candidate `172.16.1.2` has a higher priority, it is selected as the RP for the multicast group `224.0.0.0/4`.

See the following configuration output for Switch D.

```
awplus#show ip pim sparse-mode rp mapping
This system is the Bootstrap Router (v2)
Group(s): 224.0.0.0/4
  RP: 10.10.1.5
    Info source: 172.16.1.2, via bootstrap, priority 192
    Uptime: 00:00:13, expires: 00:02:29
  RP: 172.16.1.2
    Info source: 172.16.1.2, via bootstrap, priority 2
    Uptime: 00:34:42, expires: 00:01:49
```

RP details

The `show ip pim sparse-mode rp-hash` command displays information about the RP router for a particular group. See the following configuration output for **Switch D**. This output shows that 172.16.1.2 has been chosen as the RP for the multicast group 224.0.1.3.

```
awplus#show ip pim sparse-mode rp-hash 224.0.1.3
Group(s): 224.0.0.0/4
RP: 172.16.1.2
Info source: 172.16.1.2, via bootstrap
```

After RP information reaches all PIM switches in the domain, various state machines maintain all routing states as the result of Join/Prune messages from members of the multicast group.

Bootstrap Router configuration

Every PIM multicast group needs to be associated with the IP address of a Rendezvous Point (RP). This address is used as the root of a group-specific distribution tree, whose branches extend to all nodes in the domain that want to receive traffic sent to the group. For all senders to reach all receivers, all devices in the domain use the same mappings of group addresses to RP addresses. In order to determine the RP for a multicast group, a PIM device maintains a collection of group-to-RP mappings, called the RP-Set.

The Bootstrap Router (BSR) mechanism for the class of multicast routing protocols in the PIM domain uses the concept of an RP as a means for receivers to discover the sources that send to a particular multicast group. The BSR mechanism is one way that a multicast router can learn the set of group-to-RP mappings required in order to function.

Some of the PIM devices within a PIM domain are configured as RP candidates. A subset of the RP candidates will eventually be used as the actual RPs for the domain. An RP configured with a lower value in the priority field has higher a priority.

Some of the PIM devices in the domain are configured to be BSR candidates. One of these BSR candidates is elected to be the BSR for the domain, and all PIM devices in the domain learn the result of this election through Bootstrap messages (BSM). The BSR candidate with highest value in the priority field is the elected BSR.

The RP candidates then report their candidacy to the elected BSR, which chooses a subset of the RP candidates, and distributes corresponding group-to-RP mappings to all the devices in the domain through Bootstrap messages.

Note The BSR function will not work properly if there are PIM routers using VRRP.



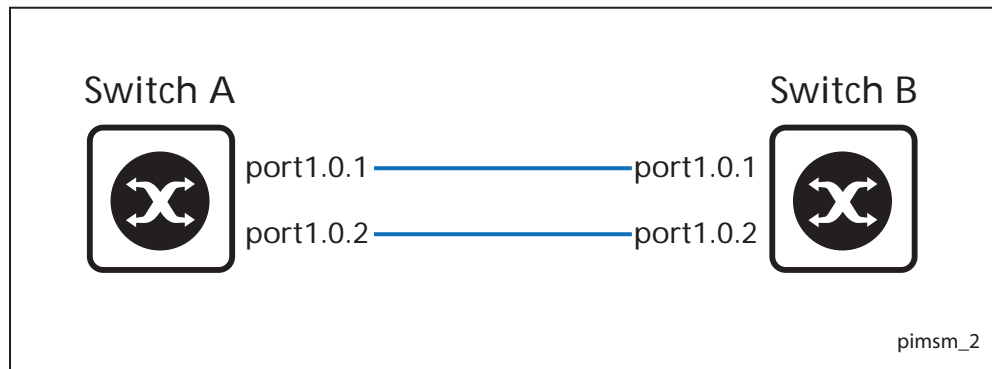

Switch A Enter the following commands to configure port1.0.1 on Switch A as the BSR candidate. The default priority is 64.

```
awplus# configure terminal
awplus(config)# ip pim bsr-candidate port1.0.1
awplus(config)# exit
```

Switch B Enter the following commands to configure port1.0.1 on Switch B as the BSR candidate with a hash mask length of 10 and a priority of 25 and to configure port1.0.1 as the RP candidate with a priority of 0.

```
awplus# configure terminal
awplus(config)# ip pim bsr-candidate port1.0.1 10 25
awplus(config)# ip pim rp-candidate port1.0.1 priority 0
awplus(config)# exit
```

Validation Commands

Use the `show ip pim sparse-mode bsr-router` command to verify the BSR candidate state on Switch A.

```
awplus#show ip pim sparse-mode bsr-router
PIMv2 Bootstrap information
This system is the Bootstrap Router (BSR)
BSR address: 20.0.1.21
Uptime:      00:37:12, BSR Priority: 64, Hash mask length: 10
Expires:     00:01:32
Role: Candidate BSR
State: Elected BSR
```

Use the `show ip pim sparse-mode bsr-router` command to verify the BSR candidate state on Switch B. The initial state of the BSR candidate is pending before transitioning to BSR candidate.

```
awplus#show ip pim sparse-mode bsr-router
PIMv2 Bootstrap information
  BSR address: 20.0.1.21
  Uptime:      00:02:39, BSR Priority: 64, Hash mask length: 10
  Expires:     00:00:03
  Role: Candidate BSR
  State: Pending BSR

awplus#show ip pim sparse-mode bsr-router
PIMv2 Bootstrap information
  BSR address: 20.0.1.21
  Uptime:      00:40:20, BSR Priority: 64, Hash mask length: 10
  Expires:     00:02:07
  Role: Candidate BSR
  State: Candidate BSR
```

Use the `show ip pim sparse-mode rp mapping` command to verify RP-set information on Switch A.

```
awplus#show ip pim sparse-mode rp mapping
PIM Group-to-RP Mappings
This system is the Bootstrap Router (v2)
Group(s): 224.0.0.0/4
RP: 20.0.1.11
  Info source: 20.0.1.11, via bootstrap, priority 0
  Uptime: 00:00:30, expires: 00:02:04
```

Use the `show ip pim sparse-mode rp mapping` command to verify RP-set information on Switch B.

```
awplus#show ip pim sparse-mode rp mapping
PIM Group-to-RP Mappings
Group(s): 224.0.0.0/4
RP: 20.0.1.11
  Info source: 20.0.1.21, via bootstrap, priority 0
  Uptime: 00:00:12, expires: 00:02:18
```



Chapter 45: PIM-SM Commands



Command List	45.2
clear ip pim sparse-mode bsr rp-set *	45.2
debug pim sparse-mode	45.3
debug pim sparse-mode timer	45.4
ip pim accept-register list	45.6
ip pim anycast-rp	45.7
ip pim bsr-border	45.8
ip pim bsr-candidate	45.9
ip pim cisco-register-checksum	45.9
ip pim cisco-register-checksum group-list	45.10
ip pim crp-cisco-prefix	45.11
ip pim dr-priority	45.12
ip pim exclude-genid	45.13
ip pim hello-holdtime (PIM-SM)	45.14
ip pim hello-interval (PIM-SM)	45.15
ip pim ignore-rp-set-priority	45.16
ip pim jp-timer	45.16
ip pim neighbor-filter (PIM-SM)	45.17
ip pim register-rate-limit	45.18
ip pim register-rp-reachability	45.18
ip pim register-source	45.19
ip pim register-suppression	45.20
ip pim rp-address	45.21
ip pim rp-candidate	45.23
ip pim rp-register-kat	45.24
ip pim sparse-mode	45.25
ip pim sparse-mode passive	45.26
ip pim spt-threshold	45.27
ip pim spt-threshold group-list	45.28
ip pim ssm	45.29
show debugging pim sparse-mode	45.30
show ip pim sparse-mode bsr-router	45.30
show ip pim sparse-mode interface	45.31
show ip pim sparse-mode interface detail	45.33
show ip pim sparse-mode mroute	45.34
show ip pim sparse-mode mroute detail	45.36
show ip pim sparse-mode neighbor	45.38
show ip pim sparse-mode nexthop	45.39
show ip pim sparse-mode rp-hash	45.40
show ip pim sparse-mode rp mapping	45.41
undebg all pim sparse-mode	45.41

Command List

This chapter provides an alphabetical reference of PIM-SM commands. For commands common to PIM-SM and PIM-DM, see [Chapter 43, Common Multicast Commands](#).

Note  The Bootstrap Router (BSR) function will not work properly if there are PIM-SM routers using VRRP.

clear ip pim sparse-mode bsr rp-set *

Use this command to clear all Rendezvous Point (RP) sets learned through the PIMv2 Bootstrap Router (BSR).

Syntax `clear ip pim sparse-mode bsr rp-set *`

Parameter	Description
*	Clears all RP sets.

Mode Privileged Exec

Usage For multicast clients, note that one router will be automatically or statically designated as the RP, and all routers must explicitly join through the RP. A Designated Router (DR) sends periodic Join/Prune messages toward a group-specific RP for each group that it has active members.

For multicast sources, note that the Designated Router (DR) unicasts Register messages to the RP encapsulated with data packets from the multicast source. The RP forwards decapsulated data packets from the source toward group members.

Example

```
awplus# clear ip pim sparse-mode bsr rp-set *
```

debug pim sparse-mode

Use this command to activate/de-activate all PIM-SM debugging.

Syntax `debug pim sparse-mode [all] [events] [mfc] [mib] [nexthop] [nsm] [packet] [state] [mtrace]`

`no debug pim sparse-mode [all] [events] [mfc] [mib] [nexthop] [nsm] [packet] [state] [mtrace]`

Parameter	Description
all	Activates/deactivates all PIM-SM debugging.
events	Activates debug printing of events.
mfc	Activates debug printing of MFC (Multicast Forwarding Cache in kernel) add/delete/updates.
mib	Activates debug printing of PIM-SM MIBs.
nexthop	Activates debug printing of PIM-SM nexthop communications.
nsm	Activates debugging of PIM-SM Network Services Module communications.
packet	Activates debug printing of incoming and/or outgoing packets.
state	Activates debug printing of state transition on all PIM-SM FSMs.
mtrace	Activates debug printing of multicast traceroute.

Mode Privileged Exec and Global Configuration

Example

```
awplus# configure terminal
awplus(config)# debug pim sparse-mode all
```

Related Commands [show debugging pim sparse-mode](#)
[undebug all pim sparse-mode](#)

debug pim sparse-mode timer

Use this command to enable debugging for the specified PIM-SM timers.

Use the **no** variants of this command to disable debugging for the specified PIM-SM timers.

Syntax

```

debug pim sparse-mode timer assert [at]
no debug pim sparse-mode timer assert [at]
debug pim sparse-mode timer bsr [bst|crp]
no debug pim sparse-mode timer bsr [bst|crp]
debug pim sparse-mode timer hello [ht|nlt|tht]
no debug pim sparse-mode timer hello [ht|nlt|tht]
debug pim sparse-mode timer joinprune [jt|et|ppt|kat|ot]
no debug pim sparse-mode timer joinprune [jt|et|ppt|kat|ot]
debug pim sparse-mode timer register [rst]
no debug pim sparse-mode timer register [rst]

```

Parameter	Description
assert	Enable or disable debugging for the Assert timers.
at	Enable or disable debugging for the Assert Timer.
bsr	Enable or disable debugging for the specified Bootstrap Router timer, or all Bootstrap Router timers.
bst	Enable or disable debugging for the Bootstrap Router: Bootstrap Timer.
crp	Enable or disable debugging for the Bootstrap Router: Candidate-RP Timer.
hello	Enable or disable debugging for the specified Hello timer, or all Hello timers.
ht	Enable or disable debugging for the Hello timer: Hello Timer.
nlt	Enable or disable debugging for the Hello timer: Neighbor Liveness Timer.
tht	Enable or disable debugging for the Hello timer: Triggered Hello Timer.
joinprune	Enable or disable debugging for the specified JoinPrune timer, or all JoinPrune timers.
jt	Enable or disable debugging for the JoinPrune timer: upstream Join Timer.
et	Enable or disable debugging for the JoinPrune timer: Expiry Timer.
ppt	Enable or disable debugging for the JoinPrune timer: PrunePending Timer.
kat	Enable or disable debugging for the JoinPrune timer: KeepAlive Timer.
ot	Enable or disable debugging for the JoinPrune timer: Upstream Override Timer.
register	Enable or disable debugging for the Register timers.
rst	Enable or disable debugging for the Register timer: Register Stop Timer.

Default By default, all debugging is disabled.

Mode Privileged Exec and Global Configuration

Examples To enable debugging for the PIM-SM Bootstrap Router bootstrap timer, use the commands:

```
awplus(config)# debug pim sparse-mode timer bsr bst
```

To enable debugging for the PIM-SM Hello: neighbor liveness timer, use the command:

```
awplus(config)# debug pim sparse-mode timer hello ht
```

To enable debugging for the PIM-SM Joinprune expiry timer, use the command:

```
awplus# debug pim sparse-mode timer joinprune et
```

To disable debugging for the PIM-SM Register timer, use the command:

```
awplus# no debug pim sparse-mode timer register
```

Related Commands [show debugging pim sparse-mode](#)

ip pim accept-register list

Use this command to configure the ability to filter out multicast sources specified by the given access-list at the Rendezvous Point (RP), so that the RP will accept/refuse to perform the register mechanism for the packets sent by the specified sources. By default, the RP accepts register packets from all multicast sources.

Use the **no** variant of this command to revert to default.

Syntax `ip pim accept-register list{<simplerange>|<exprange>|<access-list>}`
`no ip pim accept-register`

Parameter	Description
<code><simplerange></code>	<100-199> IP extended access-list.
<code><exprange></code>	<2000-2699> IP extended access list (expanded range).
<code><access-list></code>	IP Named Standard Access list.

Mode Global Configuration

Example

```
awplus# configure terminal
awplus(config)# ip pim accept-register list 121
awplus(config)# access-list 121 permit ip 100.1.1.1 0.0.0.0 any
```

ip pim anycast-rp

Use this command to configure Anycast RP (Rendezvous Point) in a RP set.

Use the **no** variant of this command to remove the configuration.

Syntax `ip pim anycast-rp <anycast-rp-address> <member-rp-address>`
`no ip pim anycast-rp <anycast-rp-address> [<member-rp-address>]`

Parameter	Description
<code><anycast-rp-address></code>	<100-199> IP extended access-list.
<code><member-rp-address></code>	<2000-2699> IP extended access list (expanded range).

Mode Global Configuration

Usage Anycast is a network addressing and routing scheme where data is routed to the nearest or best destination as viewed by the routing topology. Compared to unicast with a one-to-one association between network address and network endpoint, and multicast with a one-to-many association between network address and network endpoint; anycast has a one-to-many association between network address and network endpoint. For anycast, each destination address identifies a set of receiver endpoints, from which only one receiver endpoint is chosen.

Anycast is often implemented using BGP to simultaneously advertise the same destination IP address range from many sources, resulting in packets address to destination addresses in this range being routed to the nearest source announcing the given destination IP address.

Use this command to specify the Anycast RP configuration in the Anycast RP set. Use the **no** variant of this command to remove the Anycast RP configuration. Note that the member RP address is optional when using the **no** parameter to remove the Anycast RP configuration. removing the anycast RP address also removes the member RP address.

Examples The following example shows how to configure the Anycast RP address with **ip pim anycast-rp**:

```
awplus# configure terminal
awplus(config)# ip pim anycast-rp 1.1.1.1 10.10.10.10
```

The following example shows how to remove the Anycast RP in the RP set specifying only the anycast RP address with **no ip pim anycast-rp**, but not specifying the member RP address:

```
awplus# configure terminal
awplus(config)# no ip pim anycast-rp 1.1.1.1
```

ip pim bsr-border

Use the **ip pim bsr-border** command to prevent Bootstrap Router (BSR) messages from being sent or received through a VLAN interface. The BSR border is the border of the PIM domain.

Use the **no** variant of this command to disable the configuration set with **ip pim bsr-border**.

Syntax `ip pim bsr-border`

`no ip pim bsr-border`

Mode Interface Configuration for a VLAN interface.

Usage When this command is configured on a VLAN interface, no PIM version 2 BSR messages will be sent or received through the interface. Configure an interface bordering another PIM domain with this command to avoid BSR messages from being exchanged between the two PIM domains.

BSR messages should not be exchanged between different domains, because devices in one domain may elect Rendezvous Points (RPs) in the other domain, resulting in loss of isolation between the two PIM domains that would stop the PIM protocol from working as intended.

Examples The following example configures the interface specified to be the PIM domain border:

```
awplus# configure terminal
awplus(config)# interface vlan2
awplus(config-if)# ip pim bsr-border
```

The following example removes the interface specified from the PIM domain border:

```
awplus# configure terminal
awplus(config)# interface vlan2
awplus(config-if)# no ip pim bsr-border
```

ip pim bsr-candidate

Use this command to give the device the candidate BSR (Bootstrap Router) status using the specified IP address mask of the interface.

Use the **no** variant of this command to disable this function to remove the BSR candidate.

Syntax `ip pim bsr-candidate <interface> [<hash>] [<priority>]`
`no ip pim bsr-candidate [<interface>]`

Parameter	Description
<interface>	The interface. For instance, <code>vlan2</code> .
<hash>	<0-32> configure hash mask length for RP selection.
<priority>	<0-255> configure priority for a BSR candidate. Note that you must also specify the <hash> (mask length) when specifying the <priority>.

Mode Global Configuration

Examples To set the BSR candidate to a specified interface enter the command shown below:

```
awplus# configure terminal
awplus(config)# ip pim bsr-candidate vlan2 20 30
```

To disable this function and remove the BSR candidate from a specified interface enter:

```
awplus# configure terminal
awplus(config)# no ip pim bsr-candidate vlan2
```

ip pim cisco-register-checksum

Use this command to configure the option to calculate the Register checksum over the whole packet. This command is used to inter-operate with older Cisco IOS versions.

Use the **no** variant of this command to disable this option.

Syntax `ip pim cisco-register-checksum`
`no ip pim cisco-register-checksum`

Default This command is disabled by default. By default, Register Checksum is calculated only over the header.

Mode Global Configuration

Example

```
awplus# configure terminal
awplus(config)# ip pim cisco-register-checksum
```

ip pim cisco-register-checksum group-list

Use this command to configure the option to calculate the Register checksum over the whole packet on multicast groups specified by the access-list. This command is used to inter-operate with older Cisco IOS versions.

Use the **no** variant of this command to revert to default settings.

Syntax

```
ip pim cisco-register-checksum group-list
  [<simpplerange>|<exprange>|<access-list>]

no ip pim cisco-register-checksum group-list
  [<simpplerange>|<exprange>|<access-list>]
```

Parameter	Description
<simpplerange>	<1-99> Simple access-list.
<exprange>	<1300-1999> Simple access-list (expanded range).
<access-list>	IP Named Standard Access list.

Mode Global Configuration

Example

```
awplus# configure terminal
awplus(config)# ip pim cisco-register-checksum group-list 34
awplus(config)# access-list 34 permit 224.0.1.3
```

ip pim crp-cisco-prefix

Use this command to interoperate with Cisco devices that conform to an earlier draft standard. Some Cisco devices might not accept candidate RPs with a group prefix number of zero. Note that the latest BSR specification prohibits sending RP advertisements with prefix 0. RP advertisements for the default IPv4 multicast group range 224/4 are sent with a prefix of 1.

Use the **no** variant of this command to revert to the default settings.

Syntax `ip pim crp-cisco-prefix`
`no ip pim crp-cisco-prefix`

Mode Global Configuration

Usage Cisco's BSR code does not conform to the latest BSR draft, it does not accept candidate RPs with a group prefix number of zero. To make the candidate RP work with a Cisco BSR, use the **ip pim crp-cisco-prefix** command when interoperating with older versions of Cisco IOS.

Example

```
awplus# configure terminal
awplus(config)# ip pim crp-cisco-prefix
```

Related Commands [ip pim rp-candidate](#)

ip pim dr-priority

Use this command to set the Designated Router priority value.

Use the **no** variant of this command to disable this function.

Syntax `ip pim dr-priority <priority>`
`no ip pim dr-priority`

Parameter	Description
<code><priority></code>	<code><0-4294967294></code> The priority value. A higher value has a higher preference.

Default The default value is 1. The negated form of this command restores the value to the default.

Mode Interface Configuration for a VLAN interface.

Examples To set the Designated Router priority value apply the example commands shown below:

```
awplus# configure terminal
awplus(config)# interface vlan2
awplus(config-if)# ip pim dr-priority 11234
```

To disable Designated Router priority value apply the example commands shown below:

```
awplus# configure terminal
awplus(config)# interface vlan2
awplus(config-if)# no ip pim dr-priority
```

Related Commands [ip pim ignore-rp-set-priority](#)

ip pim exclude-genid

Use this command to exclude the GenID option from Hello packets sent out by the PIM module on a particular interface. This command is used to inter-operate with older Cisco IOS versions.

Use the **no** variant of this command to revert to default settings.

Syntax `ip pim exclude-genid`
`no ip pim exclude-genid`

Default By default, this command is disabled; the GenID option is included.

Mode Interface Configuration for a VLAN interface.

Example

```
awplus# configure terminal
awplus(config)# interface vlan2
awplus(config-if)# ip pim exclude-genid
```

ip pim hello-holdtime (PIM-SM)

This command configures a hello-holdtime value. You cannot configure a hello-holdtime value that is less than the current hello-interval.

Use the **no** variant of this command to return it to its default value of $3.5 * \text{the current hello-interval}$.

Syntax `ip pim hello-holdtime <holdtime>`
`no ip pim hello-holdtime`

Parameter	Description
<code><holdtime></code>	<code><1-65535></code> The holdtime value in seconds (no fractional seconds are accepted).

Default The default hello-holdtime value is $3.5 * \text{the current hello-interval}$. The default hello-holdtime is restored using the negated form of this command.

Mode Interface Configuration for a VLAN interface.

Usage Each time the hello interval is updated, the hello holdtime is also updated, according to the following rules:

If the hello holdtime is not configured; or if the hello holdtime is configured and less than the current hello-interval value, it is modified to the $(3.5 * \text{hello interval})$. Otherwise, it retains the configured value.

Example

```
awplus# configure terminal
awplus(config)# interface vlan2
awplus(config-if)# ip pim hello-holdtime 123
```

ip pim hello-interval (PIM-SM)

This command configures a hello-interval value.

Use the **no** variant of this command to reset the hello-interval to the default value.

Syntax `ip pim hello-interval <interval>`
`no ip pim hello-interval`

Parameter	Description
<code><interval></code>	<code><1-65535></code> The value in seconds (no fractional seconds accepted).

Default The default hello-interval value is 30 seconds. The default is restored using the negated form of this command.

Mode Interface Configuration for a VLAN interface.

Usage When the hello interval is configured, and the hello holdtime is not configured, or when the configured hello-holdtime value is less than the new hello-interval value; the holdtime value is modified to the (3.5 * hello interval). Otherwise, the hello-holdtime value is the configured value.

Example

```
awplus# configure terminal
awplus(config)# interface vlan2
awplus(config-if)# ip pim hello-interval 123
```

ip pim ignore-rp-set-priority

Use this command to ignore the RP-SET priority value, and use only the hashing mechanism for RP selection.

This command is used to inter-operate with older Cisco IOS versions.

Use the **no** variant of this command to disable this setting.

Syntax `ip pim ignore-rp-set-priority`
`no ip pim ignore-rp-set-priority`

Mode Global Configuration

Example

```
awplus# configure terminal
awplus(config)# ip pim ignore-rp-set-priority
```

ip pim jp-timer

Use this command to set the join/prune timer.

Syntax `ip pim jp-timer <1-65535>`

Parameter	Description
<1-65535>	Specifies the Join/Prune timer value.

Mode Global Configuration

Example

```
awplus# configure terminal
awplus(config)# ip pim jp-timer 234
```

ip pim neighbor-filter (PIM-SM)

This command enables filtering of neighbors on the VLAN interface. When configuring a neighbor filter, PIM-SM will either not establish adjacency with the neighbor, or terminate adjacency with the existing neighbors if denied by the filtering access list.

Use the **no** variant of this command to disable this function.

Syntax `ip pim neighbor-filter {<number>|<accesslist>}`
`no ip pim neighbor-filter {<number>|<accesslist>}`

Parameter	Description
<code><number></code>	<1-99> Standard IP access-list number.
<code><accesslist></code>	IP access list name.

Default By default, there is no filtering.

Mode Interface Configuration for a VLAN interface.

Example

```
awplus# configure terminal
awplus(config)# interface vlan2
awplus(config-if)# ip pim neighbor-filter 14
```

ip pim register-rate-limit

Use this command to configure the rate of register packets sent by this DR, in units of packets per second.

Use the **no** variant of this command to remove the limit.

Syntax `ip pim register-rate-limit <1-65535>`
`no ip pim register-rate-limit`

Parameter	Description
<1-65535>	Specifies the maximum number of packets that can be sent per second.

Mode Global Configuration

Example

```
awplus# configure terminal
awplus(config)# ip pim register-rate-limit 3444
```

ip pim register-rp-reachability

Use this command to enable the RP reachability check for PIM Register processing at the DR. The default setting is no checking for RP-reachability.

Use the **no** variant of this command to disable this processing.

Syntax `ip pim register-rp-reachability`
`no ip pim register-rp-reachability`

Default This command is disabled; by default, there is no checking for RP-reachability.

Mode Global Configuration

Example

```
awplus# configure terminal
awplus(config)# ip pim register-rp-reachability
```

ip pim register-source

Use this command to configure the source address of register packets sent by this DR, overriding the default source address, which is the address of the RPF interface toward the source host.

Use the **no** variant of this command to un-configure the source address of Register packets sent by this DR, reverting back to use the default source address that is the address of the RPF interface toward the source host.

The configured address must be a reachable address to be used by the RP to send corresponding Register-Stop messages in response. It is normally the loopback interface address, but can also be other physical addresses. This address must be advertised by unicast routing protocols on the DR. The configured interface does not have to be PIM enabled.

Syntax `ip pim register-source [<sourceaddress>|<interface>]`
`no ip pim register-source`

Parameter	Description
<code><sourceaddress></code>	The IP address, entered in the form A . B . C . D, to be used as the source of the register packets.
<code><interface></code>	The name of the interface to be used as the source of the register packets.

Mode Global Configuration

Example

```
awplus# configure terminal
awplus(config)# ip pim register-source 10.10.1.3
```

ip pim register-suppression

Use this command to configure the register-suppression time, in seconds, overriding the default value of 60 seconds. Configuring this value modifies register-suppression time at the DR. Configuring this value at the RP modifies the RP-keepalive-period value if the [ip pim rp-register-kat command on page 45.24](#) is not used.

Use the **no** variant of this command to reset the value to its default of 60 seconds.

Syntax `ip pim register-suppression <1-65535>`
`no ip pim register-suppression`

Parameter	Description
<code><1-65535></code>	Register suppression on time in seconds.

Mode Global Configuration

Example

```
awplus# configure terminal
awplus(config)# ip pim register-suppression 192
```

ip pim rp-address

Use this command to statically configure RP (Rendezvous Point) address for multicast groups.

Use the **no** variant of this command to remove a statically configured RP (Rendezvous Point) address for multicast groups.

Syntax

```
ip pim rp-address <ip-address>
    [<simplerange> | <expandedrange> | <accesslist>] [<override>]

no ip pim rp-address <ip-address>
    [<simplerange> | <expandedrange> | <accesslist>] [<override>]
```

Parameter	Description
<ip-address>	IP address of Rendezvous Point, entered in the form A.B.C.D.
<simplerange>	<1-99> IP Standard Access-list.
<expandedrange>	<1300-1999> IP Standard Access-list (expanded range).
<accesslist>	IP extended Access-list name.
<override>	Enables statically defined RPs to override dynamically learned RPs.

Mode Global Configuration

Usage The AlliedWare Plus™ PIM-SM implementation supports multiple static RPs. It also supports usage of static-RP and BSR mechanism simultaneously. The **ip pim rp-address** command is used to statically configure the RP address for multicast groups.

You need to understand the following information before using this command.

If the RP-address that is configured by the BSR, and the RP-address that is configured statically, are both available for a group range, then the RP-address configured through BSR is chosen over the statically configured RP-address.

A single static-RP can be configured for multiple group ranges using Access Lists. However, configuring multiple static RPs (using **ip pim rp-address** command) with the same RP address is not allowed. The static-RP can either be configured for the whole multicast group range 224.0.0.0/4 (without ACL) or for specific group ranges (using ACL).

For example, configuring **ip pim rp-address 192.168.3.4** will configure static-RP 192.168.3.4 for the default group range 224.0.0.0/4. Configuring **ip pim rp-address 192.168.7.8 grp-list** will configure static-RP 192.168.7.8 for all the group ranges represented by permit filters in grp-list ACL.

If multiple static-RPs are available for a group range, then one with the highest IP address is chosen.

Only **Permit** filters in ACL are considered as valid group ranges. The default **Permit** filter 0.0.0.0/0 is converted to the default multicast filter 224.0.0.0/4.

After configuration, the RP-address is inserted into a static-RP group tree based on the configured group ranges. For each group range, multiple static-RPs are maintained in a linked list. This list is sorted in a descending order of IP addresses. When selecting static-RPs for a group range, the first element (which is the static-RP with highest IP address) is chosen.

RP-address deletion is handled by removing the static-RP from all the existing group ranges and recalculating the RPs for existing TIB states if required.

Group mode and RP address mappings learned through BSR take precedence over mappings statistically defined by the `ip pim rp-address` command with the `override` keyword. Commands with the `override` keyword take precedence over dynamically learned mappings.

Example

```
awplus# configure terminal
awplus(config)# ip pim rp-address 192.168.3.4 4
```

Related Commands `ip pim rp-candidate`
`ip pim rp-register-kat`

ip pim rp-candidate

Use this command to give the router the candidate RP (Rendezvous Point) status using the IP address of the specified interface.

Use the **no** variant of this command to remove the RP status set using the **ip pim rp-candidate** command.

Syntax

```
ip pim rp-candidate <interface>
    [priority <priority>|interval <interval>| grouplist <grouplist>]
no ip pim rp-candidate [<interface>]
```

Parameter	Description
<interface>	Interface name
<priority>	<0-255> configure priority for an RP candidate.
<interval>	advertisement interval specified in the range <1-16383> (in seconds).
<grouplist>	IP access list specifier for standard, expanded or named access lists in their respective ranges: [<1-99> WORD]

Default The priority value for a candidate RP is 0 by default until specified using the **priority** parameter.

Mode Global Configuration

Usage Note that issuing the command **ip pim rp-candidate <interface>** without optional **priority**, **interval**, or **grouplist** parameters will configure the candidate RP with a priority value of 0.

Examples

```
awplus# configure terminal
awplus(config)# ip pim rp-candidate vlan2 priority 3

awplus# configure terminal
awplus(config)# ip pim rp-candidate vlan2 priority 3
group-list 3

awplus# configure terminal
awplus(config)# no ip pim rp-candidate vlan2
```

Related Commands

- [ip pim rp-address](#)
- [ip pim rp-register-kat](#)

ip pim rp-register-kat

Use this command to configure the Keep Alive Time (KAT) for (S,G) states at the RP (Rendezvous Point) to monitor PIM Register packets.

Use the **no** variant of this command to remove a previously configured KAT time with **ip pim rp-register-kat**.

Syntax `ip pim rp-register-kat <1-65535>`
`no ip pim rp-register-kat`

Parameter	Description
<1-65536>	KAT time in seconds.

Mode Global Configuration

Examples

```
awplus# configure terminal
awplus(config)# ip pim rp-register-kat 3454

awplus# configure terminal
awplus(config)# no ip pim rp-register-kat
```

Related Commands `ip pim rp-address`
`ip pim rp-candidate`

ip pim sparse-mode

Use this command to enable PIM-SM on the VLAN interface.

Use the **no** variant of this command to disable PIM-SM on the VLAN interface.

Syntax ip pim sparse-mode
no ip pim sparse-mode

Mode Interface Configuration for a VLAN interface.

Examples

```
awplus# configure terminal
awplus(config)# interface vlan2
awplus(config-if)# ip pim sparse-mode
```

```
awplus# configure terminal
awplus(config)# interface vlan2
awplus(config-if)# no ip pim sparse-mode
```

ip pim sparse-mode passive

Use this command to enable and disable passive mode operation for local members on the VLAN interface.

Use the **no** variant of this command to disable passive mode operation for local members on the VLAN interface.

Syntax `ip pim sparse-mode passive`
`no ip pim sparse-mode passive`

Mode Interface Configuration for a VLAN interface.

Usage Passive mode essentially stops PIM transactions on the interface, allowing only IGMP mechanism to be active. To turn off passive mode, use the **no ip pim sparse-mode passive** or the **ip pim sparse-mode** command. To turn off PIM activities on the VLAN interface, use the **no ip pim sparse-mode** command.

Examples

```
awplus# configure terminal
awplus(config)# interface vlan2
awplus(config-if)# ip pim sparse-mode passive
```

```
awplus# configure terminal
awplus(config)# interface vlan2
awplus(config-if)# no ip pim sparse-mode passive
```

ip pim spt-threshold

This command turns on the ability for the last-hop PIM router to switch to SPT.

The **no** variant of this command turns off the ability for the last-hop PIM router to switch to SPT.

Note The switching to SPT happens either at the receiving of the first data packet, or not at all; it is not rate-based.



Syntax ip pim spt-threshold
no ip pim spt-threshold

Mode Global Configuration

Examples

```
awplus# configure terminal
awplus(config)# ip pim spt-threshold
```

```
awplus# configure terminal
awplus(config)# no ip pim spt-threshold
```

ip pim spt-threshold group-list

Use this command to turn on/off the ability for the last-hop PIM router to switch to SPT for multicast group addresses specified by the given access-list.

The switching to SPT happens either at the receiving of the first data packet, or not at all; it is not rate-based.

Use the **no** variant of this command to turn off switching to the SPT.

Syntax `ip pim spt-threshold group-list {<simpplerange>|<expandedrange>|<named-accesslist>}`
`no ip pim spt-threshold group-list [<simpplerange>|<expandedrange>|<named-accesslist>]`

Parameter	Description
<simpplerange>	<1-99> IP Standard Access-list.
<expandedrange>	<1300-1999> IP Standard Access-list (expanded range).
<named-accesslist>	IP Access-list name.

Mode Global Configuration

Usage Turn on/off the ability for the last-hop PIM router to switch to SPT for multicast group addresses specified by the given access-list.

Example

```
awplus# configure terminal
awplus(config)# ip pim spt-threshold group-list 1
awplus(config)# access-list 1 permit 224.0.1.3
```

ip pim ssm

Use this command to define the Source Specific Multicast (SSM) range of IP multicast addresses. The default keyword defines the SSM range as 232/8. To define the SSM range to be other than the default, use the access-list parameter option.

Use the **no** variant of this command to disable the SSM range.

Syntax

```
ip pim ssm default
ip pim ssm range {<accesslist>|<named-accesslist>}
no ip pim ssm
```

Parameter	Description
<accesslist>	<1-99> Simple access-list.
<named-accesslist>	Named Standard Access List.

Default By default, the command is disabled.

Mode Global Configuration

Usage When an SSM range of IP multicast addresses is defined by the ip pim ssm command, the no (*,G) or (S,G,rpt) state will be initiated for groups in the SSM range.

The messages corresponding to these states will not be accepted or originated in the SSM range.

Examples The following commands show how to configure SSM service for the IP address range defined by access list 10:

```
awplus# configure terminal
awplus(config)# access-list 10 permit 225.1.1.1
awplus(config)# ip pim ssm range 4
```

The following commands show how to disable PIM-SSM :

```
awplus# configure terminal
awplus(config)# no ip pim ssm
```

show debugging pim sparse-mode

This command displays the status of the debugging of the system.

For information on output options, see [“Controlling “show” Command Output” on page 1.35.](#)

Syntax show debugging pim sparse-mode

Mode Privileged Exec

Example To display PIM-SM debugging settings, use the command:

```
awplus# show debugging pim sparse-mode
```

Figure 45-1: output from the **show debugging pim sparse-mode** command

```
Debugging status:
PIM event debugging is on
PIM Hello THT timer debugging is on
PIM event debugging is on
PIM MFC debugging is on
PIM state debugging is on
PIM packet debugging is on
PIM incoming packet debugging is on
PIM outgoing packet debugging is on
```

Related Commands [debug pim sparse-mode](#)

show ip pim sparse-mode bsr-router

Use this command to show the Bootstrap Router (BSR) (v2) address.

For information on output options, see [“Controlling “show” Command Output” on page 1.35.](#)

Syntax show ip pim sparse-mode bsr-router

Mode User Exec and Privileged Exec

Output Figure 45-2: output from the **show ip pim sparse-mode bsr-router** command

```
PIMv2 Bootstrap information
BSR address: 10.10.11.35 (?)
Uptime:      00:00:38, BSR Priority: 0, Hash mask length: 10
Expires:     00:01:32
Role: Non-candidate BSR
State: Accept Preferred
```

Related Commands [show ip pim sparse-mode rp mapping](#)
[show ip pim sparse-mode neighbor](#)

show ip pim sparse-mode interface

Use this command to show PIM-SM interface information.

For information on output options, see [“Controlling “show” Command Output” on page 1.35.](#)

Syntax `show ip pim sparse-mode interface`

Mode User Exec and Privileged Exec

Example To display information about PIM-SM interfaces, use the command:

```
awplus# show ip pim sparse-mode interface
```

Output

Figure 45-3: Example output from the `show ip pim sparse-mode interface` command

```
Total configured interfaces: 100    Maximum allowed: 100
Total active interfaces:      100
```

Address	Interface	VIFindex	Ver/ Mode	Nbr Count	DR Prior	DR
10.1.100.4	vlan100	4	v2/S	2	1	10.1.100.6
10.2.101.10	vlan1001	5	v2/S	0	1	10.2.101.10
10.2.102.10	vlan1002	6	v2/S	0	1	10.2.102.10
10.2.103.10	vlan1003	7	v2/S	0	1	10.2.103.10
10.2.104.10	vlan1004	8	v2/S	0	1	10.2.104.10
10.2.105.10	vlan1005	9	v2/S	0	1	10.2.105.10
10.2.106.10	vlan1006	10	v2/S	0	1	10.2.106.10
10.2.107.10	vlan1007	11	v2/S	0	1	10.2.107.10

1. Only the top entries output by this command are shown in this example.

Table 45-1: Parameters in the output from the **show ip pim sparse-mode interface** command

Parameters	Description
Total configured interfaces	The number of configured PIM Sparse Mode interfaces.
Maximum allowed	The maximum number of PIM Dense Mode interfaces that can be configured.
Total active interfaces	The number of active PIM Sparse Mode interfaces.
Address	Primary PIM-SM address.
Interface	Name of the PIM-SM interface.
VIF Index	The Virtual Interface index of the VLAN.
Ver/Mode	PIM version/Sparse mode.
Nbr Count	Neighbor count of the PIM-SM interface.
DR Priority	Designated Router priority.
DR	The IP address of the Designated Router.

Related Commands

- `ip pim sparse-mode`
- `show ip pim sparse-mode rp mapping`
- `show ip pim sparse-mode neighbor`

show ip pim sparse-mode interface detail

Use this command to show detailed information on a PIM-SM interface.

For information on output options, see [“Controlling “show” Command Output” on page 1.35.](#)

Syntax show ip pim sparse-mode interface detail

Mode User Exec and Privileged Exec

Output Figure 45-4: Example output from the **show ip pim sparse-mode interface detail** command

```
vlan3 (vif 3):
  Address 192.168.1.149, DR 192.168.1.149
  Hello period 30 seconds, Next Hello in 15 seconds
  Triggered Hello period 5 seconds
  Neighbors:
    192.168.1.22

vlan2 (vif 0):
  Address 10.10.11.149, DR 10.10.11.149
  Hello period 30 seconds, Next Hello in 18 seconds
  Triggered Hello period 5 seconds
  Neighbors:
    10.10.11.4
```

show ip pim sparse-mode mroute

This command displays the IP multicast routing table, or the IP multicast routing table based on the specified address or addresses.

Two group addresses cannot be used simultaneously; two source addresses cannot be used simultaneously.

Note that when a feature license is enabled, the output for the **show ip pim sparse-mode mroute** command will only show 32 interfaces because of the terminal display width limit. Use the [show ip pim sparse-mode mroute detail command on page 45.36](#) to display detailed entries of the IP multicast routing table.

For information on output options, see ["Controlling "show" Command Output" on page 1.35](#).

Syntax `show ip pim sparse-mode mroute [<group-address>] [<source-address>]`
`show ip pim sparse-mode mroute [<source-address> <group-address>]`

Parameter	Description
<code><group-address></code>	Group IP address, entered in the form A.B.C.D. Based on the group and source address, the output is the selected route if present in the multicast route tree.
<code><source-address></code>	Source IP address, entered in the form A.B.C.D. Based on the source and group address, the output is the selected route if present in the multicast route tree.

Mode User Exec and Privileged Exec

Examples

```
awplus# show ip pim sparse-mode mroute
awplus# show ip pim sparse-mode mroute 40.40.40.11
awplus# show ip pim sparse-mode mroute 235.0.0.1
awplus# show ip pim sparse-mode mroute 235.0.0.1 40.40.40.11
```

Figure 45-5: Example output from the **show ip pim sparse-mode mroute** command

```

IP Multicast Routing Table

(*,*,RP) Entries: 0
(*,G) Entries: 1
(S,G) Entries: 0
(S,G,rpt) Entries: 0
FCR Entries: 1

(*, 224.0.1.3)
RP: 10.10.5.153
RPF nbr: 192.168.1.152
RPF idx: vlan2
Upstream State: JOINED
Local .....
Joined ..j.....
Asserted .....
FCR:
Source: 10.10.1.52
Outgoing ..o.....
KAT timer running, 144 seconds remaining
Packet count 1
    
```

show ip pim sparse-mode mroute detail

This command displays detailed entries of the IP multicast routing table, or detailed entries of the IP multicast routing table based on the specified address or addresses.

Two group addresses cannot be used simultaneously; two source addresses cannot be used simultaneously.

For information on output options, see ["Controlling "show" Command Output" on page 1.35.](#)

Syntax

```
show ip pim sparse-mode mroute [<group-address> | <source-address>]
  detail

show ip pim sparse-mode mroute [<group-address> <source-address>]
  detail

show ip pim sparse-mode mroute [<source-address> <group-address>]
  detail
```

Parameter	Description
<group-address>	Group IP address, entered in the form A.B.C.D. Output is all multicast entries belonging to that group
<source-address>	Source IP address, entered in the form A.B.C.D. Output is all multicast entries belonging to that source.
detail	Show detailed information

Usage Based on the group and source address, the output is the selected route if present in the multicast route tree.

Mode User Exec and Privileged Exec

Examples

```
awplus# show ip pim sparse-mode mroute detail

awplus# show ip pim sparse-mode mroute 40.40.40.11 detail

awplus# show ip pim sparse-mode mroute 224.1.1.1 detail

awplus# show ip pim sparse-mode mroute 224.1.1.1 40.40.40.11
  detail
```

Figure 45-6: Example output from the **show ip pim sparse-mode mroute detail** command

```
IP Multicast Routing Table

(*,*,RP) Entries: 0
(*,G) Entries: 4
(S,G) Entries: 0
(S,G,rpt) Entries: 0
FCR Entries: 0

(*, 224.0.1.24) Uptime: 00:06:42
RP: 0.0.0.0, RPF nbr: None, RPF idx: None
Upstream:
  State: JOINED, SPT Switch: Disabled, JT: off
  Macro state: Join Desired,
Downstream:
  vlan2:
    State: NO INFO, ET: off, PPT: off
    Assert State: NO INFO, AT: off
    Winner: 0.0.0.0, Metric: 42949672951, Pref: 42949672951, RPT
bit: on
  Macro state: Could Assert, Assert Track
Local Olist:
  vlan2
```

show ip pim sparse-mode neighbor

Use this command to show the PIM-SM neighbor information.

For information on output options, see “Controlling “show” Command Output” on page 1.35.

Syntax `show ip pim sparse-mode neighbor [<interface>] [<ip-address>] [detail]`

Parameter	Description
<interface>	Interface name (e.g. <code>vlan2</code>). Show neighbors on an interface.
<ip-address>	Show neighbors with a particular address on an interface. The IP address entered in the form A.B.C.D.
detail	Show detailed information.

Mode User Exec and Privileged Exec

Examples

```
awplus# show ip pim sparse-mode neighbor
```

```
awplus# show ip pim sparse-mode neighbor vlan5 detail
```

Figure 45-7: Example output from the `show ip pim sparse-mode neighbor` command

Neighbor Address	Interface	Uptime/Expires	Ver	DR Priority/Mode
10.10.0.9	vlan2	00:55:33/00:01:44	v2	1 /
10.10.0.136	vlan2	00:55:20/00:01:25	v2	1 /
10.10.0.172	vlan2	00:55:33/00:01:32	v2	1 / DR
192.168.0.100	vlan3	00:55:30/00:01:20	v2	N / DR

Figure 45-8: Example output from the `show ip pim sparse-mode neighbor interface detail` command

<pre>Nbr 10.10.3.180 (vlan5), DR Expires in 55 seconds, uptime 00:00:15 Holdtime: 70 secs, T-bit: off, Lan delay: 1, Override interval: 3 DR priority: 100, Gen ID: 625159467, Secondary addresses: 192.168.30.1</pre>
--

show ip pim sparse-mode nexthop

Use this command to see the nexthop information as used by PIM-SM.

For information on output options, see [“Controlling “show” Command Output” on page 1.35.](#)

Syntax `show ip pim sparse-mode nexthop`

Mode User Exec and Privileged Exec

Example

```
awplus# show ip pim sparse-mode nexthop
```

Figure 45-9: Example output from the `show ip pim sparse-mode nexthop` command

Flags: N = New, R = RP, S = Source, U = Unreachable									
Destination	Type	Nexthop Num	Nexthop Addr	Nexthop	Nexthop Ifindex	Metric	Pref	Refcnt	Name
10.10.0.9	.RS.	1	0.0.0.0	4	0	0	1		

Table 45-2: Parameters in output of the `show ip pim sparse-mode nexthop` command

Parameter	Description
Destination	The destination address for which PIM-SM requires nexthop information.
Type	The type of destination, as indicated by the Flags description. N = New, R= RP, S = Source, U = Unreachable.
Nexthop Num	The number of nexthops to the destination. PIM-SM always uses only 1 nexthop.
Nexthop Addr	The address of the primary nexthop gateway.
Nexthop IfIndex	The interface on which the nexthop gateway can be reached.
Nexthop Name	The name of nexthop interface.
Metric	The metric of the route towards the destination.
Preference	The preference of the route towards destination.
Refcnt	Only used for debugging.

show ip pim sparse-mode rp-hash

Use this command to display the Rendezvous Point (RP) to be chosen based on the group selected.

For information on output options, see [“Controlling “show” Command Output” on page 1.35.](#)

Syntax `show ip pim sparse-mode rp-hash <group-addr>`

Parameter	Description
<code><group-addr></code>	The group address for which to find the RP, entered in the form A.B.C.D.

Mode User Exec and Privileged Exec

Example

```
awplus# show ip pim sparse-mode rp-hash 224.0.1.3
```

Figure 45-10: output from the `show ip pim sparse-mode rp-hash` command

```
RP: 10.10.11.35  
Info source: 10.10.11.35, via bootstrap
```

Related Commands `show ip pim sparse-mode rp mapping`

show ip pim sparse-mode rp mapping

Use this command to show group-to-RP (Rendezvous Point) mappings, and the RP set.

For information on output options, see [“Controlling “show” Command Output” on page 1.35.](#)

Syntax `show ip pim sparse-mode rp mapping`

Mode User Exec and Privileged Exec

Example

```
awplus# show ip pim sparse-mode rp mapping
```

Figure 45-11: output from the `show ip pim sparse-mode rp mapping` command

```
PIM Group-to-RP Mappings
Group(s): 224.0.0.0/4
  RP: 10.10.0.9
    Info source: 10.10.0.9, via bootstrap, priority 0
    Uptime: 16:52:39, expires: 00:02:50
```

Related Commands [show ip pim sparse-mode rp-hash](#)

undebug all pim sparse-mode

Use this command to disable all PIM-SM debugging.

Syntax `undebug all pim sparse-mode`

Mode Privileged Exec

Example

```
awplus# undebug all pim sparse-mode
```

Related Commands [debug pim sparse-mode](#)

Chapter 46: PIM-DM Configuration



Introduction.....	46.2
Characteristics of PIM-DM	46.2
PIM-DM Terminology.....	46.3
PIM-DM Configuration	46.4
Configuration Example.....	46.4
Verifying Configuration.....	46.6

Introduction

Protocol Independent Multicast - Dense Mode (PIM-DM) is a data-driven multicast routing protocol, which builds source-based multicast distribution trees that operate on the Flood-and-Prune principle. It requires unicast-reachability information, but does not depend on a specific unicast routing protocol.

For details of the commands used to configure PIM-DM, see [Chapter 47, PIM-DM Commands](#).

Characteristics of PIM-DM

PIM Dense Mode (PIM-DM) is a significantly less complex protocol than PIM Sparse Mode (PIM-SM). PIM-DM works on the principle that it is probable that any given multicast stream will have at least one downstream listener. PIM-DM is ideal where many hosts subscribe to receive multicast packets, so most of the PIM Routers receive and forward all multicast packets.

Where PIM-SM only forwards a multicast stream when requested, PIM-DM always floods any new multicast stream that arrives at the PIM Router and only stops flooding the multicast stream on a given link if it is explicitly told to, by receiving a Prune message from the downstream PIM Router.

PIM-DM does not include the concepts of Rendezvous Points, which are used in PIM-SM. PIM-SM explicitly builds unidirectional shared trees rooted at a Rendezvous Point (RP) per group. PIM-DM implicitly builds shortest-path trees by flooding multicast traffic domain wide, then Prunes back branches of the tree where no receivers are available. As with PIM-SM, so does PIM-DM also use Reverse Path Forwarding (RPF) to stop loops for packet forwarding for PIM Routers receiving multicast packets.

PIM-DM Terminology

See the below descriptions of the terms and concepts used to describe the PIM-DM protocol:

PIM Router	Any Layer 3 routing device that is running PIM, such as an Allied Telesis managed Layer 3 switch or Allied Telesis router.
Reverse Path Forwarding	<p>Reverse Path Forwarding (RPF) is the mechanism that PIM uses to make sure it does not forward multicast streams around in loops. If a set of PIM Routers are connected in a loop, and each PIM Router is forwarding a given multicast stream, then eventually the multicast stream would be forwarded right around the loop.</p> <p>To prevent this from happening, PIM makes use of the fact that the unicast routing tables in a set of PIM Routers should converge into a loop-free tree of paths to any given destination.</p> <p>When a PIM Router receives a multicast stream from source address <code>SourceA</code> through an interface <code>IF1</code>, it checks whether <code>IF1</code> is the interface the PIM Router would use to reach <code>SourceA</code>. The PIM Router will only forward the multicast stream if <code>IF1</code> is the interface the PIM Router would use to reach <code>SourceA</code>.</p> <p>RPF determines whether the interface is correct by consulting unicast routing tables. This ensure that the multicast stream is forwarded in a loop-free manner back up the tree of unicast paths that lead to the source.</p>
Forwarding Multicast Packets	<p>PIM Routers forward a given multicast stream onto all PIM enabled IP interfaces that have not received a Prune for the given multicast stream. As with unicast routing, the PIM Router decrements the TTL (Time To Live) in each packet that the PIM Router forwards. The packet is discarded if the TTL is decremented to 0.</p> <p>However, unlike unicast routing, the destination MAC addresses of the packets are not altered as they are forwarded by the PIM Router. The destination MAC addresses remain set to the multicast MAC addresses that correspond to the destination group address of the multicast stream.</p>
Upstream	Towards the Source.
Downstream	Anything other than the upstream interface for that group.

PIM-DM Configuration

The main requirement is to enable PIM-DM on the desired interfaces. This section provides a PIM-DM configuration example for a relevant scenario. The configuration uses Allied Telesis managed Layer 3 Switches as the PIM Routers. Three PIM Routers are connected in a chain, and a multicast client is attached to the third PIM Router.

Configuration Example

In this example, the address of the multicast source is 10.10.1.52. The following figure displays the network topology used in this example:

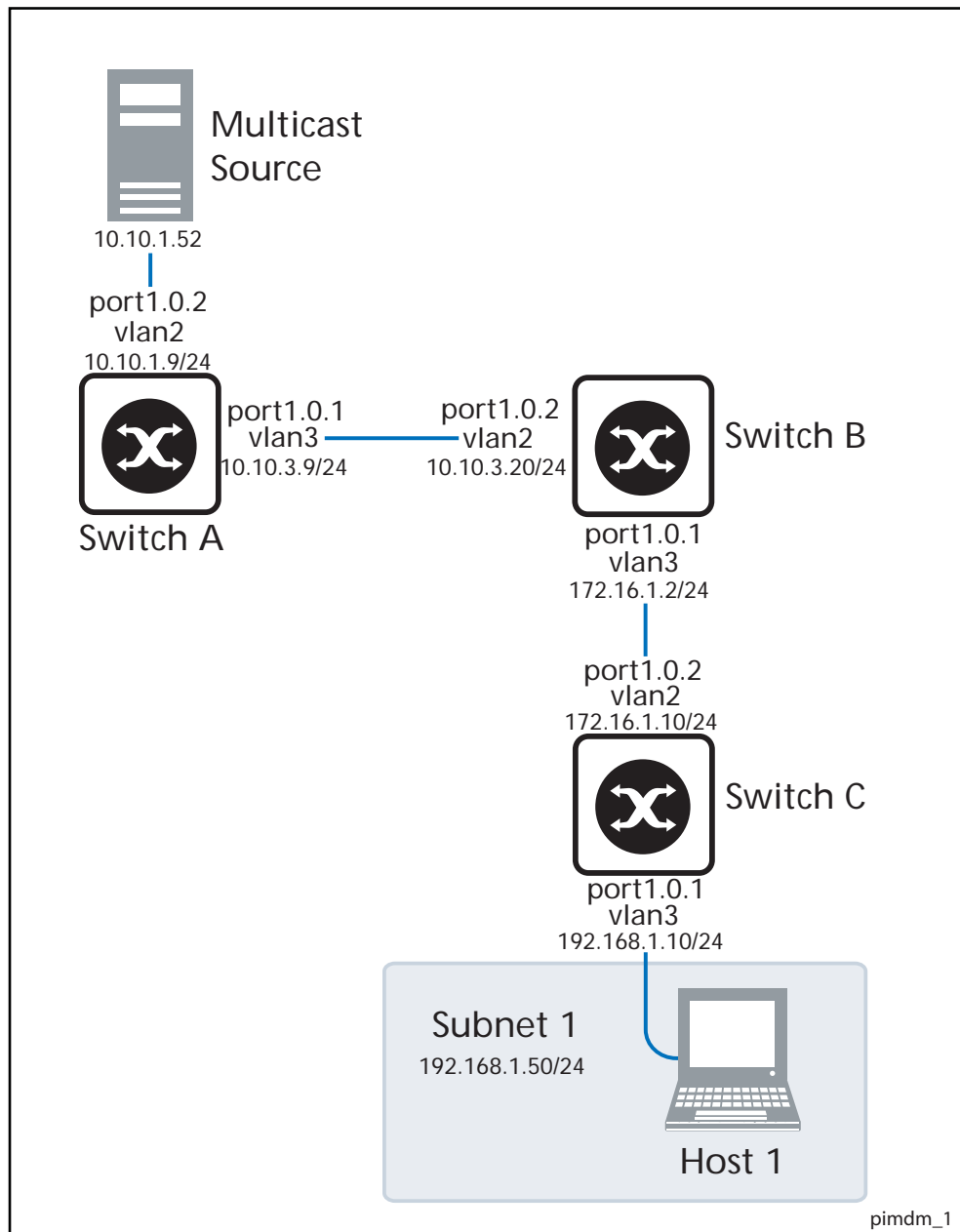

The steps involved in the forwarding of the multicast streams for this sample configuration are:

- Switch A**
1. When the PIM Routers start, they use the exchange of PIM Hello packets for PIM neighbor relationships with each other. Then each PIM Router becomes aware of the location of its PIM neighbors.
 2. As a multicast stream arrives from the source to **Switch A**, it performs an RPF check on the source IP address of the multicast stream. **Switch A** determines the best route to the source IP address (10.10.1.52) is the receiving interface, so it forwards the multicast stream to its only PIM neighbor.
 3. **Switch A** creates an (S, G) (Source, Group) entry in its PIM-DM forwarding table. Any further packets from the same source, which are destined to be forwarded to the same group, will be automatically forwarded without an RFP (Reverse Path Forwarding) check.
- Switch B**
4. When the multicast stream arrives at **Switch B**, it performs the same steps (2 and 3) as **Switch A**. This results in **Switch B** also having an (S, G) entry for the multicast stream in its PIM forwarding table, and the multicast stream is forwarded to **Switch C**.
- Switch C**
5. When the multicast stream arrives at **Switch C**, it will perform an RPF check on the multicast stream as it arrives, and accept it.

This PIM Router does not have any downstream PIM Routers, but if **Switch C** has received an IGMP report from the client to request this multicast stream, **Switch C** will forward the multicast stream out port1.0.1, but no other ports.

If the client leaves the group, and **Switch C** has no other attached clients requesting the group, then **Switch C** will send a Prune message upstream, resulting in **Switch A** and **Switch B** stopping forwarding the multicast stream to **Switch C**.

Switch A Configuration Output

See the following configuration output for **Switch A**:

```
hostname Switch A
vlan database
vlan 2 state enable
vlan 3 state enable
interface vlan2
ip address 10.10.1.9/24
ip igmp
ip pim dense-mode
!
interface vlan3
ip address 10.10.3.9/24
ip igmp
ip pim dense-mode
!
interface port1.0.1
switchport access vlan 3
!
interface port1.0.2
switchport access vlan 2
!
ip multicast-routing
!
```

Switch B Configuration Output

See the following configuration output for Switch B:

```
hostname Switch B
vlan database
vlan 2 state enable
vlan 3 state enable
interface vlan2
ip address 10.10.3.20/24
ip igmp
ip pim dense-mode
!
interface vlan3
ip address 172.16.1.2/24
ip igmp
ip pim dense-mode
!
interface port1.0.1
switchport access vlan 3
!
interface port1.0.2
switchport access vlan 2
!
ip multicast-routing
!
```

Switch C Configuration Output

See the following configuration output for Switch C:

```
hostname Switch C
vlan database
vlan 2 state enable
vlan 3 state enable
interface vlan2
ip address 172.16.1.10/24
ip igmp
ip pim dense-mode
!
interface vlan3
ip address 192.168.1.10/24
ip igmp
ip pim dense-mode
!
interface port1.0.1
switchport access vlan 3
!
interface port1.0.2
switchport access vlan 2
!
ip multicast-routing
!
```

Verifying Configuration

Use the following commands to verify the interface details and multicast routing table.

Interface Details

The `show ip pim dense-mode interface` command displays the interface details for Switch C.

Address	Interface	VIFindex	Ver/ Mode	Nbr Count
192.168.1.10	port1.0.1	0	v2/D	0
172.16.1.10	port1.0.2	2	v2/D	1

IP Multicast Routing Table

The `show ip mroute` command displays the IP multicast routing table (for Switch C).

```
IP Multicast Routing Table
Flags: I - Immediate Stat, T - Timed Stat, F - Forwarder
installed
Timers: Uptime/Stat Expiry
Interface State: Interface (TTL)

(10.10.1.52, 224.0.1.3), uptime 00:00:15
Owner PIM-DM, Flags: F
  Incoming interface: port1.0.2
  Outgoing interface list:
    port1.0.1 (1)
```

IP PIM-DM Multicast Routing Table

The `show ip pim dense-mode mroute` command displays the IP PIM-DM multicast routing table (for Switch C).

```
PIM-DM Multicast Routing Table
(10.10.1.52, 224.0.1.3)
  RPF Neighbor: 172.16.1.2, Nexthop: 172.16.1.2, port1.0.2
  Upstream IF: port1.0.2
  Upstream State: Forwarding
  Assert State: NoInfo
  Downstream IF List:
    port1.0.1, in 'olist':
      Downstream State: NoInfo
      Assert State: NoInfo
```

Chapter 47: PIM-DM Commands



Command List	47.2
debug pim dense-mode all.....	47.2
debug pim dense-mode context	47.3
debug pim dense-mode decode.....	47.4
debug pim dense-mode encode.....	47.4
debug pim dense-mode fsm.....	47.5
debug pim dense-mode mrt	47.5
debug pim dense-mode nexthop.....	47.6
debug pim dense-mode nsm	47.7
debug pim dense-mode vif.....	47.7
ip pim dense-mode.....	47.8
ip pim dense-mode passive.....	47.8
ip pim hello-holdtime (PIM-DM)	47.9
ip pim hello-interval (PIM-DM).....	47.10
ip pim max-graft-retries.....	47.11
ip pim neighbor-filter (PIM-DM)	47.12
ip pim propagation-delay.....	47.13
ip pim state-refresh origination-interval	47.14
show debugging pim dense-mode.....	47.14
show ip pim dense-mode interface.....	47.15
show ip pim dense-mode interface detail	47.17
show ip pim dense-mode mroute	47.18
show ip pim dense-mode neighbor	47.19
show ip pim dense-mode neighbor detail.....	47.20
show ip pim dense-mode nexthop.....	47.21
undebg all pim dense-mode	47.22

Command List

This chapter provides an alphabetical reference of PIM-DM commands. For commands common to PIM-SM and PIM-DM, see [Chapter 43, Common Multicast Commands](#).

debug pim dense-mode all

This command enables PIM-DM debugging.

The **no** variant of this command disables PIM-DM debugging.

Syntax `debug pim dense-mode all`
`no debug pim dense-mode all`

Mode Privileged Exec and Global Configuration

Example

```
awplus# configure terminal
awplus(config)# debug pim dense-mode all
```

Output Figure 47-1: Example output from the **debug pim dense-mode all** command

```
PIM event debugging is on
PIM MFC debugging is on
PIM state debugging is on
PIM packet debugging is on
PIM incoming packet debugging is on
PIM outgoing packet debugging is on
```

Validation Commands `show debugging pim dense-mode`

Related Commands `debug pim dense-mode context`
`debug pim dense-mode decode`
`debug pim dense-mode encode`
`debug pim dense-mode fsm`
`debug pim dense-mode mrt`
`debug pim dense-mode nexthop`
`debug pim dense-mode nsm`
`debug pim dense-mode vif`

debug pim dense-mode context

This command enables debugging of general configuration and Virtual Routing (VR), and Virtual Routing and Forwarding (VRF) context.

The **no** variant of this command disables debugging of general configuration and Virtual Routing (VR), and Virtual Routing and Forwarding (VRF) context.

Syntax `debug pim dense-mode context`
`no debug pim dense-mode context`

Mode Privileged Exec and Global Configuration

Example

```
awplus# configure terminal
awplus(config)# debug pim dense-mode context
```

Related Commands `debug pim dense-mode all`
`debug pim dense-mode decode`
`debug pim dense-mode encode`
`debug pim dense-mode fsm`
`debug pim dense-mode mrt`
`debug pim dense-mode nexthop`
`debug pim dense-mode nsm`
`debug pim dense-mode vif`

debug pim dense-mode decode

This command enables debugging of the PIM-DM message decoder.

The **no** variant of this command disables debugging of the PIM-DM message decoder.

Syntax `debug pim dense-mode decode`
`no debug pim dense-mode decode`

Mode Privileged Exec and Global Configuration

Example

```
awplus# configure terminal
awplus(config)# debug pim dense-mode decoder
```

Related Commands `debug pim dense-mode all`
`debug pim dense-mode context`
`debug pim dense-mode encode`
`debug pim dense-mode fsm`
`debug pim dense-mode mrt`
`debug pim dense-mode nexthop`
`debug pim dense-mode nsm`
`debug pim dense-mode vif`

debug pim dense-mode encode

This command enables debugging of the PIM-DM message encoder.

The **no** variant of this command disables debugging of the PIM-DM message encoder.

Syntax `debug pim dense-mode encode`
`no debug pim dense-mode encode`

Mode Privileged Exec and Global Configuration

Example

```
awplus# configure terminal
awplus(config)# debug pim dense-mode encoder
```

Related Commands `debug pim dense-mode all`
`debug pim dense-mode context`
`debug pim dense-mode decode`
`debug pim dense-mode fsm`
`debug pim dense-mode mrt`
`debug pim dense-mode nexthop`
`debug pim dense-mode nsm`
`debug pim dense-mode vif`

debug pim dense-mode fsm

This command enables debugging of Finite-State Machine (FSM) specific information of all Multicast Routing Table (MRT) and MRT Virtual Multicast Interface (MRT-VIF) entries.

The **no** variant of this command disables debugging of Finite-State Machine (FSM) specific information of all Multicast Routing Table (MRT) and MRT Virtual Multicast Interface (MRT-VIF) entries.

Syntax `debug pim dense-mode fsm`
`no debug pim dense-mode fsm`

Mode Privileged Exec and Global Configuration

Example

```
awplus# configure terminal
awplus(config)# debug pim dense-mode fsm
```

Related Commands `debug pim dense-mode all`
`debug pim dense-mode context`
`debug pim dense-mode decode`
`debug pim dense-mode encode`
`debug pim dense-mode mrt`
`debug pim dense-mode nexthop`
`debug pim dense-mode nsm`
`debug pim dense-mode vif`

debug pim dense-mode mrt

This command enables debugging of MRT and MRT-VIF entry handling (for example, creation and deletion of).

The **no** variant of this command disables debugging of MRT and MRT-VIF entry handling.

Syntax `debug pim dense-mode mrt`
`no debug pim dense-mode mrt`

Mode Privileged Exec and Global Configuration

Example

```
awplus# configure terminal
awplus(config)# debug pim dense-mode mrt
```

Related Commands `debug pim dense-mode all`
`debug pim dense-mode context`
`debug pim dense-mode decode`
`debug pim dense-mode encode`
`debug pim dense-mode fsm`
`debug pim dense-mode nexthop`

```
debug pim dense-mode nsm
debug pim dense-mode vif
```

debug pim dense-mode nexthop

This command enables debugging of Reverse Path Forwarding (RPF) neighbor nexthop cache handling.

The **no** variant of this command disables debugging of Reverse Path Forwarding (RPF) neighbor nexthop cache handling.

Syntax `debug pim dense-mode nexthop`
`no debug pim dense-mode nexthop`

Mode Privileged Exec and Global Configuration

Example

```
awplus# configure terminal
awplus(config)# debug pim dense-mode nexthop
```

Related Commands `debug pim dense-mode all`
`debug pim dense-mode context`
`debug pim dense-mode decode`
`debug pim dense-mode encode`
`debug pim dense-mode fsm`
`debug pim dense-mode mrt`
`debug pim dense-mode nsm`
`debug pim dense-mode vif`

debug pim dense-mode nsm

This command enables debugging of PIM-DM interface with NSM.

The **no** variant of this command disables debugging of PIM-DM interface with NSM.

Syntax `debug pim dense-mode nsm`
`no debug pim dense-mode nsm`

Mode Privileged Exec and Global Configuration

Example

```
awplus# configure terminal
awplus(config)# debug pim dense-mode nsm
```

Related Commands `debug pim dense-mode all`
`debug pim dense-mode context`
`debug pim dense-mode decode`
`debug pim dense-mode encode`
`debug pim dense-mode fsm`
`debug pim dense-mode mrt`
`debug pim dense-mode nexthop`
`debug pim dense-mode vif`

debug pim dense-mode vif

This command enables debugging of VIF handling.

The **no** variant of this command disables debugging of VIF handling.

Syntax `debug pim dense-mode vif`
`no debug pim dense-mode vif`

Mode Privileged Exec and Global Configuration

Example

```
awplus# configure terminal
awplus(config)# debug pim dense-mode vif
```

Related Commands `debug pim dense-mode all`
`debug pim dense-mode context`
`debug pim dense-mode decode`
`debug pim dense-mode encode`
`debug pim dense-mode fsm`
`debug pim dense-mode mrt`
`debug pim dense-mode nexthop`
`debug pim dense-mode nsm`

ip pim dense-mode

This command enables or disables PIM-DM operation from Interface mode on the current VLAN interface. This command also disables passive mode on the VLAN interface if passive mode has been enabled using an `ip pim dense-mode passive` command.

The **no** variant of this command disables all PIM-DM activities on the interface.

Syntax `ip pim dense-mode`
`no ip pim dense-mode`

Mode Interface Configuration for a VLAN interface.

Example

```
awplus# configure terminal
awplus(config)# interface vlan2
awplus(config-if)# ip pim dense-mode
```

ip pim dense-mode passive

This command enables PIM-DM passive mode operation from Interface mode on the current VLAN interface.

The **no** variant of this command disables passive mode.

Syntax `ip pim dense-mode passive`
`no ip pim dense-mode passive`

Mode Interface Configuration for a VLAN interface.

Usage Configuring a VLAN interface as a passive PIM-DM interface indicates that the VLAN interface is connected to a stub network (i.e. a network that does not contain any PIM Routers). So, multicast streams that arrive on other PIM-DM interfaces can be routed to hosts on the passive PIM-DM interface, but no PIM neighbor relationships will be formed on the passive PIM-DM interface.

Example

```
awplus# configure terminal
awplus(config)# interface vlan2
awplus(config-if)# ip pim dense-mode passive
```

ip pim hello-holdtime (PIM-DM)

This command configures a **hello-holdtime**. The PIM **hello-holdtime** on a VLAN interface is the period which the router will wait to receive a hello from neighbors on that interface. If the router does not receive a hello from a given neighbor within that period, then it will decide that the neighbor is no longer an active PIM Router, and will terminate the neighbor relationship.

You cannot configure a **hello-holdtime** value that is less than the current **hello-interval**. Each time the **hello-interval** is updated, the **hello-holdtime** is also updated, according to the following rules:

- If the **hello-holdtime** is not configured; or if the hello holdtime is configured and less than the current **hello-interval** value, it is modified to 3.5 times the **hello-interval** value.
- Otherwise, it retains the configured value.

Use the **no** variant of this command to return the hello-holdtime value to its default value of 3.5 times the current hello-interval value.

Syntax `ip pim hello-holdtime <holdtime>`

`no ip pim hello-holdtime`

Parameter	Description
<code><holdtime></code>	<code><1-65535></code> The holdtime value in seconds (no fractional seconds are accepted).

Mode Interface Configuration for a VLAN interface.

Example

```
awplus# configure terminal
awplus(config)# interface vlan2
awplus(config-if)# ip pim hello-holdtime 123
```

ip pim hello-interval (PIM-DM)

This command configures a PIM **hello-interval** value. The PIM **hello-interval** on a VLAN interface is the period at which the router will transmit PIM hello messages on that interface.

When the **hello-interval** is configured, and the **hello-holdtime** is not configured, or when the configured **hello-holdtime** value is less than the new **hello-interval** value; the **hello-holdtime** value is modified to 3.5 times the **hello-interval** value. Otherwise, the **hello-holdtime** value is the configured value. The default is 30 seconds.

Use the **no** variant of this command to reset the **hello-interval** to the default value.

Syntax `ip pim hello-interval <interval>`
`no ip pim hello-interval`

Parameter	Description
<code><interval></code>	<code><1-65535></code> the value in seconds (no fractional seconds accepted).

Mode Interface Configuration for a VLAN interface.

Example

```
awplus# configure terminal
awplus(config)# interface vlan2
awplus(config-if)# ip pim hello-interval 123
```

ip pim max-graft-retries

This command configures PIM-DM to send a limited number of Graft message retries, after which time the device will remove all information regarding the particular (Source, Group), or until the device receives an acknowledgment, whichever occurs first.

The **no** variant of this command configures PIM-DM to send Graft message retries until the device receives an acknowledgment, which is the default behavior.

Syntax `ip pim max-graft-retries <1-65535>`
`no pim max-graft-retries`

Parameter	Description
<code>no</code>	Negate a command or set its defaults
<code>ip</code>	Internet Protocol (IP)
<code>pim</code>	PIM Interface commands
<code>max-graft-retries</code>	PIM Graft message retries
<code><1-65535></code>	Graft message retries before ceasing Graft message retries.

Default By default, Graft retries are sent by PIM-DM until the device receives an acknowledgement.

Mode Interface Configuration for a VLAN interface.

Usage Graft messages are used to reduce the join latency when a previously pruned branch of the source tree must be grafted back, when a member joins the group after the PIM-DM device has sent a Prune message to prune unwanted traffic. Graft messages are the only PIM-DM messages that receive an acknowledgement.

If Graft messages were not used, then the member waiting for pruned off traffic would have to wait up to 3 minutes for the periodic re-flooding to occur to begin receiving multicast traffic again. By using Grafts, the Prune can be reversed much faster than waiting for periodic re-flooding to begin receiving multicast traffic again.

Examples To configure PIM-DM to send a maximum of 10 Graft message retries, use the following commands:

```
awplus# configure terminal
awplus(config)# interface vlan2
awplus(config-if)# ip pim max-graft-retries 10
```

To configure PIM-DM to send Graft message retries forever, which is the default behavior, use the following commands:

```
awplus# configure terminal
awplus(config)# interface vlan2
awplus(config-if)# no ip pim max-graft-retries
```

Validation show ip mroute
Commands show ip pim dense-mode mroute
 show running-config

ip pim neighbor-filter (PIM-DM)

Enables filtering of neighbors on the VLAN interface. When configuring a neighbor filter, PIM-DM will either not establish adjacency with the neighbor, or terminate adjacency with the existing neighbors if denied by the filtering access list.

Use the **no** variant of this command to disable this function.

Syntax ip pim neighbor-filter [*<number>*|*<accesslist>*]
 no ip pim neighbor-filter [*<number>*|*<accesslist>*]

Parameter	Description
<i><number></i>	<i><1-99></i> Standard IP access list number.
<i><accesslist></i>	IP access list name.

Default By default, there is no filtering.

Mode Interface Configuration for a VLAN interface.

Example

```
awplus# configure terminal
awplus(config)# interface vlan2
awplus(config-if)# ip pim neighbor-filter 14
```

ip pim propagation-delay

This command configures the PIM **propagation-delay** value. The PIM **propagation-delay** is the expected delay in the transfer of PIM messages across the VLAN interface that it is attached to.

Use the **no** variant of this command to return the **propagation-delay** to the default value (1000 milliseconds).

Syntax `ip pim propagation-delay <delay>`
`no ip pim propagation-delay`

Parameter	Description
<code><delay></code>	<code><1000-5000></code> the value in milliseconds. The default value is 1000 milliseconds.

Default The propagation-delay is set to 1000 milliseconds by default.

Mode Interface Configuration for a VLAN interface.

Examples

```
awplus# configure terminal
awplus(config)# interface vlan2
awplus(config-if)# ip pim propagation-delay 2000

awplus# configure terminal
awplus(config)# interface vlan2
awplus(config-if)# no ip pim propagation-delay
```

ip pim state-refresh origination-interval

This command configures a PIM **state-refresh origination-interval** value. The origination interval is the number of seconds between PIM state refresh control messages. The default is 60 seconds.

Use the **no** variant of this command to return the origination interval to the default value.

Syntax `ip pim state-refresh origination-interval <interval>`
`no ip pim state-refresh origination-interval`

Parameter	Description
<interval>	<1-100> the integer value in seconds (no fractional seconds accepted). The default state-refresh origination-interval value is 60.

Default The state-refresh origination-interval is set to 60 seconds by default, and is reset using negation.

Mode Interface Configuration for a VLAN interface.

Example

```
awplus# configure terminal
awplus(config)# interface vlan2
awplus(config-if)# ip pim state-refresh origination-interval 65
```

show debugging pim dense-mode

This command displays the status of the debugging of the system.

For information on output options, see [“Controlling “show” Command Output” on page 1.35.](#)

Syntax `show debugging pim dense-mode`

Mode User Exec and Privileged Exec

Output Figure 47-2: Example output from the **show debugging pim dense-mode** command

```
PIM-DM Debugging status:
PIM-DM VR-VRF Context debugging is off
PIM-DM Decoder debugging is off
PIM-DM Encoder debugging is off
PIM-DM FSM debugging is off
PIM-DM MRT debugging is off
PIM-DM NHOP debugging is off
PIM-DM NSM debugging is off
PIM-DM VIF debugging is off
```

Related Commands `debug pim dense-mode all`

show ip pim dense-mode interface

This command displays the PIM-DM interface information.

For information on output options, see [“Controlling “show” Command Output” on page 1.35.](#)

Syntax show ip pim dense-mode interface

Mode User Exec and Privileged Exec

Example To display information about the PIM-DM interfaces, use the command:

```
awplus# show ip pim dense-mode interface
```

Output

Figure 47-3: Example output from the **show ip pim dense-mode interface** command

```
Total configured interfaces: 100   Maximum allowed: 100
Total active interfaces:      100

Address           Interface VIFIndex Ver/  Nbr
                  Mode      Count
10.1.100.4        vlan100   4       v2/D  0
10.2.101.10       vlan1001  5       v2/D  0
10.2.102.10       vlan1002  6       v2/D  0
10.2.103.10       vlan1003  7       v2/D  0
10.2.104.10       vlan1004  8       v2/D  0
10.2.105.10       vlan1005  9       v2/D  0
10.2.106.10       vlan1006  10      v2/D  0
10.2.107.10       vlan1007  11      v2/D  0
```

1. Only the top entries output by this command are shown in this example.

Table 47-1: Parameters in the output of the **show ip pim dense-mode interface** command

Parameter	Description
Total configured interfaces	The number of configured PIM Dense Mode interfaces.
Maximum allowed	The maximum number of PIM Dense Mode interfaces that can be configured.
Total active interfaces	The number of active PIM Dense Mode interfaces.
Address	Primary PIM-DM address.
Interface	Name of the PIM-DM interface.
VIF Index	The Virtual Interface index of the VLAN.
Ver/Mode	PIM version/Dense mode.
Nbr Count	Neighbor count of the PIM-DM interface.

Related Commands `ip pim dense-mode`
`show ip pim dense-mode neighbor`

show ip pim dense-mode interface detail

This command displays detailed information on a PIM-DM interface.

For information on output options, see [“Controlling “show” Command Output”](#) on page 1.35.

Syntax show ip pim dense-mode interface detail

Mode User Exec and Privileged Exec

Example

```
awplus# show ip pim dense-mode interface detail
```

Output Figure 47-4: Example output from the **show ip pim dense-mode interface detail** command

```
vlan2 (vif-id: 0):
  Address 192.168.1.53/24
  Hello period 30 seconds, Next Hello in 30 seconds
  Neighbors:
    192.168.1.152/32
    192.168.1.149/32
vlan3 (vif-id: 2):
  Address 192.168.10.53/24
  Hello period 30 seconds, Next Hello in 8 seconds
  Neighbors: none
```

show ip pim dense-mode mroute

This command displays the IP PIM-DM multicast routing table.

For information on output options, see “Controlling “show” Command Output” on page 1.35.

Syntax show ip pim dense-mode mroute

Mode User Exec and Privileged Exec

Example

```
awplus# show ip pim dense-mode mroute
```

Output Figure 47-5: Example output from the show ip pim dense-mode mroute command

```
PIM-DM Multicast Routing Table
(192.168.10.52, 224.1.1.1)
  Source directly connected on vlan3
  State-Refresh Originator State: Originator
  Upstream IF: vlan3, State: Forwarding
  Downstream IF List:
    vlan2, in 'olist':
      Downstream State: NoInfo
      Assert State: NoInfo
```

show ip pim dense-mode neighbor

This command displays PIM-DM neighbor information.

For information on output options, see [“Controlling “show” Command Output” on page 1.35.](#)

Syntax show ip pim dense-mode neighbor

Mode User Exec and Privileged Exec

Usage The total number of PIM-DM neighbors is restricted to 500 PIM-DM neighbors.

When the 500 PIM-DM neighbor limit is reached, as a result of receiving hello packets from new PIM-DM neighbors, a log entry will be issued to the log file in the below format:

```
<date> <time> <facility>.<severity> <program[<pid>]>: <message>
-----
----
2008 Dec 10 00:58:39 user.err x900 PIM-DM[1150]: [VIF] Nbr
Create: Cannot create more than 500 neighbours - ignoring
neighbour 100.0.1.247/32 on vlan100
```

Example

```
awplus# show ip pim dense-mode neighbor
```

Output Figure 47-6: Example output from the **show ip pim dense-mode neighbor** command

```
Total number of neighbors: 500
Neighbor-Address  Interface          Uptime/Expires    Ver
192.168.1.152    vlan2              17:15:42/00:01:28 v2
192.168.1.149    vlan2              17:15:34/00:01:34 v2
```

show ip pim dense-mode neighbor detail

This command displays detailed PIM-DM neighbor information.

For information on output options, see [“Controlling “show” Command Output”](#) on page 1.35.

Syntax show ip pim dense-mode neighbor detail

Mode User Exec and Privileged Exec

Example

```
awplus# show ip pim dense-mode neighbor detail
```

Output Figure 47-7: Example output from the **show ip pim dense-mode neighbor detail** command

```
Neighbor 192.168.1.152 (vlan2)
  Up since 17:16:20, Expires in 00:01:20
Neighbor 192.168.1.149 (vlan2)
  Up since 17:16:12, Expires in 00:01:26
```

show ip pim dense-mode nexthop

This command displays the nexthop information as used by PIM-DM. In the context of PIM-DM, the term 'nexthop' refers to the nexthop router on the path back to the source address of a multicast stream.

For information on output options, see [“Controlling “show” Command Output” on page 1.35.](#)

Syntax `show ip pim dense-mode nexthop`

Mode User Exec and Privileged Exec

Example

```
awplus# show ip pim dense-mode nexthop
```

Output Figure 47-8: Example output from the `show ip pim dense-mode neighbor nexthop` command

Destination Pref	Nexthop Num	Nexthop Addr	Nexthop Interface	Metric	
192.168.10.52	1	0.0.0.0	vlan2	3	1

Table 47-2: Parameters in the output of the `show ip pim dense-mode neighbor nexthop` command

Parameter	Description
Destination	Destination address for which PIM-DM requires nexthop information
Nexthop Num	Number of nexthops to the destination. PIM can only use one nexthop
Nexthop Addr	Address of the current nexthop gateway
Nexthop Interface	Name of the nexthop interface
Metric	Metric of the route towards the destination
Preference	Preference of the route towards the destination

undebg all pim dense-mode

Use this command from the Global Configuration mode to disable all PIM-DM debugging.

Syntax `undebg all pim dense-mode`

Mode Global Configuration

Example

```
awplus# configure terminal
awplus(config)# undebg all pim dense-mode
```

Related Commands

- `debug pim dense-mode all`
- `debug pim dense-mode context`
- `debug pim dense-mode decode`
- `debug pim dense-mode encode`
- `debug pim dense-mode fsm`
- `debug pim dense-mode mrt`
- `debug pim dense-mode nexthop`
- `debug pim dense-mode nsm`
- `debug pim dense-mode vif`

Chapter 48: MLD Snooping Commands



Introduction.....	48.2
Command List	48.2
clear ipv6 mld.....	48.2
clear ipv6 mld group	48.3
clear ipv6 mld interface	48.3
debug mld	48.4
ipv6 mld access-group.....	48.5
ipv6 mld limit.....	48.6
ipv6 mld snooping.....	48.7
ipv6 mld snooping fast-leave	48.8
ipv6 mld snooping mrouter	48.9
ipv6 mld snooping report-suppression.....	48.10
ipv6 mld ssm-map enable	48.11
ipv6 mld ssm-map static.....	48.12
ipv6 mld static-group.....	48.13
show ipv6 mld groups.....	48.15
show ipv6 mld interface.....	48.16
show ipv6 mld snooping mrouter	48.17
show ipv6 mld snooping statistics.....	48.18

Introduction

Multicast Listener Discovery (MLD) is used to exchange membership status information between IPv6 routers that support multicasting and members of multicast groups on a network segment. Host membership in a multicast group is reported by individual member hosts, and membership status is periodically polled by multicast routers. MLD is defined in RFC 2710, "Multicast Listener Discovery (MLD) for IPv6."

MLD Snooping is a feature whereby a layer 2 switch listens to or "snoops" the MLD messages passing through the switch or from member hosts and multicast routers.

The purpose of MLD Snooping is to provide efficient layer 2 multicast forwarding, by sending only to hosts that have expressed an interest in receiving the multicast data.

Hosts express an interest in receiving multicast data for a given multicast group by sending an MLD join message. Without MLD Snooping, if one host expresses an interest in getting multicast data for a given group, by sending an MLD join for the multicast group, then all hosts connected to the same vlan will also receive the multicast data. This wastes bandwidth on the switch ports connected to the host that are not interested in receiving the multicast data. Snooping takes note of exactly which ports have received joins for a given group, and send that group only to those ports.

MLD Snooping is enabled by default globally for the switch. It can be enabled and disabled on a per-vlan basis.

MLD Snooping makes a distinction between Member ports, which are ports connected to members hosts, and Router ports, which are ports connected to, or directed towards, a layer 3 router or a layer 3 switch.

Command List

This chapter provides an alphabetical reference of configuration, clear, and show commands related to MLD Snooping.

clear ipv6 mld

Use this command to clear all MLD local memberships on all interfaces.

Syntax `clear ipv6 mld`

Mode Privileged Exec

Usage This command applies to groups learned by MLD Snooping.

Example

```
awplus# clear ipv6 mld
```

Related Commands `clear ipv6 mld group`
`clear ipv6 mld interface`

clear ipv6 mld group

Use this command to clear MLD specific local-membership(s) on all interfaces, for a particular group.

Syntax `clear ipv6 mld group {* | <ipv6-address>}`

Parameter	Description
*	Clears all groups on all interfaces. This is an alias to the clear ipv6 mld command.
<ipv6-address>	Specify the group address for which MLD local-memberships are to be cleared from all interfaces. Specify the IPv6 multicast group address in the format in the format X:X::X:X

Mode Privileged Exec

Usage This command applies to groups learned by MLD Snooping.

Example

```
awplus# clear ipv6 mld group *
```

Related Commands [clear ipv6 mld](#)
[clear ipv6 mld interface](#)

clear ipv6 mld interface

Use this command to clear MLD interface entries.

Syntax `clear ipv6 mld interface <interface>`

Parameter	Description
<interface>	Specifies name of the interface; all groups learned from this interface are deleted.

Mode Privileged Exec

Usage This command applies to interfaces configured for MLD Snooping.

Example

```
awplus# clear ipv6 mld interface vlan2
```

Related Commands [clear ipv6 mld](#)
[clear ipv6 mld group](#)

debug mld

Use this command to enable all MLD debugging modes, or a specific MLD debugging mode.

Use the **no** variant of this command to disable all MLD debugging modes, or a specific MLD debugging mode.

Syntax `debug mld {all|decode|encode|events|fsm|tib}`
`no debug mld {all|decode|encode|events|fsm|tib}`

Parameter	Description
<code>all</code>	debug all MLD
<code>decode</code>	debug MLD decoding
<code>encode</code>	debug MLD encoding
<code>events</code>	debug MLD events
<code>fsm</code>	debug MLD Finite State Machine (FSM)
<code>tib</code>	debug MLD Tree Information Base (TIB)

Mode Privileged Exec and Global Configuration

Examples

```
awplus# configure terminal
awplus(config)# debug mld all
```

```
awplus# configure terminal
awplus(config)# debug mld decode
```

```
awplus# configure terminal
awplus(config)# debug mld encode
```

```
awplus# configure terminal
awplus(config)# debug mld events
```

ipv6 mld access-group

Use this command to control the multicast local-membership groups learned on an interface.

Use the **no** variant of this command to disable this access control.

Syntax `ipv6 mld access-group <access-list-name>`
`no ipv6 mld access-group`

Parameter	Description
<code><access-list-name></code>	Standard IPv6 access-list name.

Default No access list is configured by default.

Mode Interface Configuration for a specified VLAN interface.

Usage This command applies to groups learned by MLD Snooping.

Example In the following example, `vlan2` will only accept MLD joins for groups in the range `ff1e:0db8:0001::/64`:

```
awplus# configure terminal
awplus(config)# ipv6 access-list standard group1 permit
                ff1e:0db8:0001::/64
awplus(config)# interface vlan2
awplus(config-if)# ipv6 mld access-group group1
```

ipv6 mld limit

Use this command to configure a limit on the maximum number of group memberships that may be learned. The limit may be set for the switch as a whole, or for a specific interface.

Once the specified group membership limit is reached, all further local-memberships will be ignored.

Optionally, an exception access-list can be configured to specify the group-address(es) that are exempted from being subject to the limit.

Use the **no** variant of this command to unset the limit and any specified exception access-list.

Syntax `ipv6 mld limit <limitvalue> [except <access-list-name>]`
`no ipv6 mld limit`

Parameter	Description
<code><limitvalue></code>	<code><2-2097152></code> Maximum number of group membership states.
<code><access-list-name></code>	Optional. Standard IPv6 access-list name that defines multicast groups which are exempted from being subject to the configured limit.

Default The default limit, which is reset by the **no** variant of this command, is the same as maximum number of group membership entries that can be learned with the **ipv6 mld limit** command.

The default limit of group membership entries that can be learned is 2097152 entries.

Mode Global Configuration and Interface Configuration for a specified VLAN interface.

Usage This command applies to interfaces learned by MLD Snooping.

If this command is issued on multiple VLAN interfaces, the limits apply individually to each of those interfaces.

Examples The following example configures an MLD limit of 100 group-memberships across all VLAN interfaces on which MLD is enabled, and excludes groups in the range `ff1e:0db8:0001::/64` from this limitation:

```
awplus# configure terminal
awplus(config)# ipv6 access-list standard v6grp permit
ff1e:0db8:0001::/64
awplus(config)# ipv6 mld limit 100 except v6grp
```

The following example configures an MLD limit of 100 group-membership states on `vlan2`:

```
awplus# configure terminal
awplus(config)# interface vlan2
awplus(config-if)# ipv6 mld limit 100
```

Related Commands [show ipv6 mld groups](#)

ipv6 mld snooping

Use this command to enable MLD Snooping. When this command is issued in the Global Configuration mode, MLD Snooping is enabled globally for the switch. When this command is issued in Interface mode for a VLAN then MLD Snooping is enabled for the specified VLAN. Note that MLD Snooping is enabled on the VLAN only if it is enabled globally and on the VLAN.

Use the **no** variant of this command to globally disable MLD Snooping in Global Configuration mode, or for the specified VLAN interface in Interface mode.

Syntax `ipv6 mld snooping`

`no ipv6 mld snooping`

Default By default, MLD Snooping is enabled both globally and on all VLANs.

Mode Global Configuration and Interface Configuration for a specified VLAN interface.

Usage For MLD snooping to operate on particular VLAN interfaces, it must be enabled both globally by using this command in Global Configuration mode, and on individual VLAN interfaces by using this command in Interface Configuration mode. (Both are enabled by default.)

Examples To configure MLD Snooping on `vlan2`, enter the following commands:

```
awplus# configure terminal
awplus(config)# interface vlan2
awplus(config-if)# ipv6 mld snooping
```

To disable MLD Snooping for `vlan2`, enter the following commands:

```
awplus# configure terminal
awplus(config)# interface vlan2
awplus(config)# no ipv6 mld snooping
```

To configure MLD Snooping globally for the switch, enter the following commands:

```
awplus# configure terminal
awplus(config)# ipv6 mld snooping
```

To disable MLD Snooping globally for the switch, enter the following commands:

```
awplus# configure terminal
awplus(config)# no ipv6 mld snooping
```

ipv6 mld snooping fast-leave

Use this command to enable MLD Snooping fast-leave processing. Fast-leave processing is analogous to immediate-leave processing; the MLD group-membership is removed as soon as an MLD leave group message is received, without sending out a group-specific query.

Use the **no** variant of this command to disable fast-leave processing.

Syntax `ipv6 mld snooping fast-leave`

`no ipv6 mld snooping fast-leave`

Default MLD Snooping fast-leave processing is disabled.

Mode Interface Configuration for a specified VLAN interface.

Usage This MLD Snooping command can only be configured on VLAN interfaces.

Example This example shows how to enable fast-leave processing on `vlan2`.

```
awplus# configure terminal
awplus(config)# interface vlan2
awplus(config-if)# ipv6 mld snooping fast-leave
```

ipv6 mld snooping mrouter

Use this command to statically configure the specified port as a Multicast Router interface for MLD Snooping within the specified VLAN.

Use the **no** variant of this command to remove the static configuration of the interface as a Multicast Router interface.

Syntax `ipv6 mld snooping mrouter interface <port>`
`no ipv6 mld snooping mrouter interface <port>`

Parameter	Description
<port>	Specify the name of the port

Mode Interface Configuration for a specified VLAN interface.

Usage This MLD Snooping command statically configures a switch port as a Multicast Router interface.

Example This example shows how to specify the next-hop interface to the multicast router.

```
awplus# configure terminal
awplus(config)# interface vlan2
awplus(config-if)# ipv6 mld snooping mrouter interface
port1.0.5
```

ipv6 mld snooping report-suppression

Use this command to enable report suppression from hosts for Multicast Listener Discovery version 1 (MLDv1) on a VLAN in interface configuration mode.

Use the **no** variant of this command to disable report suppression on a VLAN in interface configuration mode.

Syntax `ipv6 mld snooping report-suppression`
`no ipv6 mld snooping report-suppression`

Default Report suppression does not apply to MLDv2, and is turned on by default for MLDv1 reports.

Mode Interface Configuration for a specified VLAN interface.

Usage This MLD Snooping command can only be configured on VLAN interfaces.

MLDv1 snooping may be configured to suppress reports from hosts. When a querier sends a query, only the first report for particular set of group(s) from a host will be forwarded to the querier by the MLD Snooping switch. Similar reports (to the same set of groups) from other hosts, which would not change group memberships in the querier, will be suppressed by the MLD Snooping switch to prevent 'flooding' of query responses.

Examples This example shows how to enable report suppression for MLD reports on `vlan2`.

```
awplus# configure terminal
awplus(config)# interface vlan2
awplus(config-if)# ipv6 mld snooping report-suppression
```

This example shows how to disable report suppression for MLD reports on `vlan2`:

```
awplus# configure terminal
awplus(config)# interface vlan2
awplus(config-if)# no ipv6 mld snooping report-suppression
```

ipv6 mld ssm-map enable

Use this command to enable the Source Specific Multicast (SSM) mapping feature on the switch.

Use the **no** variant of this command to disable the SSM mapping feature on the switch.

Syntax `ipv6 mld ssm-map enable`
`no ipv6 mld ssm-map enable`

Mode Global Configuration

Usage This command applies to interfaces configured for MLD Snooping.
This command enables the SSM mapping feature for group members in the defined SSM range. Configure the group member and the SSM range using the [ipv6 mld ssm-map static](#) command.

Example This example shows how to enable the MLD SSM mapping feature on the switch.

```
awplus# configure terminal
awplus(config)# ipv6 mld ssm-map enable
```

Related Commands [ipv6 mld ssm-map static](#)

ipv6 mld ssm-map static

Use this command to statically define a Source Specific Multicast (SSM) mapping. The SSM mapping statically assigns sources to MLDv1 groups to translate such (*,G) groups' memberships to (S,G) memberships for use with PIM-SSM.

Use the **no** variant of this command to remove the SSM map association.

Syntax `ipv6 mld ssm-map static <access-list-name> X:X::X:X`
`no ipv6 mld ssm-map static <access-list-name> X:X::X:X`

Parameter	Description
<code><access-list-name></code>	IPv6 named standard access-list.
<code>X:X::X:X</code>	IPv6 source address that is associated with the above access-list. The IPv6 address uses the format X:X::X:X.

Mode Global Configuration

Usage This command applies to interfaces configured for MLD Snooping.

Use this command to configure SSM mappings after enabling SSM mapping with the [ipv6 mld ssm-map enable](#) command.

Example This example shows how to configure an SSM static mapping for the group-address `ff0e::1/128`.

```
awplus# configure terminal
awplus(config)# ipv6 mld ssm-map enable
awplus(config)# ipv6 access-list standard v6grp permit
                ff0e::1/128
awplus(config)# ipv6 mld ssm-map static v6grp 2006::3
```

Related Commands [ipv6 mld ssm-map enable](#)

ipv6 mld static-group

Use this command to statically configure IPv6 group membership entries on an interface. To statically add only a group membership, do not specify any parameters.

Use the **no** variant of this command to delete static group membership entries.

Syntax

```

ipv6 mld static-group <ipv6-group-address>
    [source <ipv6-source-address>|ssm-map] [interface <port>]

no ipv6 mld static-group <ipv6-group-address>
    [source <ipv6-source-address>|ssm-map] [interface <port>]

```

Parameter	Description
<ipv6-group-address>	Specify a standard IPv6 Multicast group address to be configured as a static group member. The IPv6 address uses the format X:X::X:X.
<ipv6-source-address>	Optional. Specify a standard IPv6 source address to be configured as a static source from where multicast packets originate. The IPv6 address uses the format X:X::X:X.
ssm-map	Mode of defining SSM mapping. SSM mapping statically assigns sources to MLDv1 groups to translate these (*,G) groups' memberships to (S,G) memberships for use with PIM-SSM.
<port>	Optional. Physical interface. This parameter specifies a physical port. If this parameter is used, the static configuration is applied to just to that physical interface. If this parameter is not used, the static configuration is applied on all ports in the VLAN.

Mode Interface Configuration for a specified VLAN interface.

Usage This command applies to MLD Snooping on a VLAN interface to statically add groups and/or source records.

Example The following examples show how to statically add group and/or source records for MLD Snooping on `vlan2`:

```

awplus# configure terminal
awplus(config)# interface vlan2
awplus(config-if)# ipv6 mld static-group ff1e::10

```

```

awplus# configure terminal
awplus(config)# interface vlan2
awplus(config-if)# ipv6 mld static-group ff1e::10 source
fe80::2fd:6cff:fe1c:b

```

```
awplus# configure terminal
awplus(config)# interface vlan2
awplus(config-if)# ipv6 mld static-group ff1e::10 source ssm-
map
```

```
awplus# configure terminal
awplus(config)# interface vlan2
awplus(config-if)# ipv6 mld static-group ff1e::10 interface
port1.0.8
```

```
awplus# configure terminal
awplus(config)# interface vlan2
awplus(config-if)# ipv6 mld static-group ff1e::10 source
fe80::2fd:6cff:fe1c:b interface port1.0.8
```

```
awplus# configure terminal
awplus(config)# interface vlan2
awplus(config-if)# ipv6 mld static-group ff1e::10 source ssm-
map interface port1.0.8
```

show ipv6 mld groups

Use this command to display the multicast groups with receivers directly connected to the router, and learned through MLD.

For information on output options, see [“Controlling “show” Command Output” on page 1.35.](#)

Syntax `show ipv6 mld groups [<ipv6-address> |<interface> detail]`

Parameter	Description
<ipv6-address>	Optional. Specify Address of the multicast group in format X:X:X:X
<interface>	Optional. Specify the Interface name for which to display local information.

Mode User Exec and Privileged Exec

Example The following command displays local-membership information for all interfaces:

```
awplus# show ipv6 mld groups
```

Output Figure 48-1: Example output from the `show ipv6 mld groups` command

```
MLD Connected Group Membership
Group Address      Interface      Uptime        Expires       Last
Reporter
ff1e::10           ge10           00:03:16     00:01:09
fe80::202:b3ff:fe80:79d8
```

show ipv6 mld interface

Use this command to display the state of MLD Snooping for a specified interface, or all interfaces.

For information on output options, see [“Controlling “show” Command Output” on page 1.35.](#)

Syntax `show ipv6 mld interface [<interface>]`

Parameter	Description
<interface>	Interface name

Mode User Exec and Privileged Exec

Example The following displays MLD interface status on all interfaces enabled for MLD.

```
awplus# show ipv6 mld interface
```

Output [Figure 48-2: Example output from the show ipv6 mld interface command](#)

```
Interface vlan1 (Index 2)
  MLD Enabled, Active, Querier, Version 2 (default)
  Internet address is fe80::2fd:6cff:fe1c:b
  MLD interface has 0 group-record states
  MLD activity: 0 joins, 0 leaves
  MLD query interval is 125 seconds
  MLD querier timeout is 255 seconds
  MLD max query response time is 10 seconds
  Last member query response interval is 1000 milliseconds
  Group Membership interval is 260 seconds
```

show ipv6 mld snooping mrouter

Use this command to display the multicast router interfaces, both configured and learned, in a VLAN.

For information on output options, see [“Controlling “show” Command Output” on page 1.35.](#)

Syntax `show ipv6 mld snooping mrouter <interface>`

Parameter	Description
<interface>	The name of the VLAN interface

Mode User Exec and Privileged Exec

Example The following displays the multicast router interfaces in `vlan2`

```
awplus# show ipv6 mld snooping mrouter vlan2
```

Output Figure 48-3: Example output from the `show ipv6 mld snooping mrouter` command

VLAN	Interface	Static/Dynamic
2	port1.0.2	
2	port1.0.3	

show ipv6 mld snooping statistics

Use this command to display MLD Snooping statistics data.

For information on output options, see “Controlling “show” Command Output” on page 1.35.

Syntax `show ipv6 mld snooping statistics interface <interface>`

Parameter	Description
<interface>	The name of the VLAN interface

Mode User Exec and Privileged Exec

Example The following displays MLDv2 statistical information for `vlan2`.

```
awplus# show ipv6 mld snooping statistics interface vlan2
```

Output Figure 48-4: Example output from the `show ipv6 mld snooping statistics` command

```
Interface:      vlan2
Group:          ff1e::10
Uptime:        00:00:13
Group mode:    Include
Last reporter: fe80::202:b3ff:fef0:79d8
Group source list: (R - Remote, M - SSM Mapping)
  Source Address      Uptime    v2 Exp    Fwd  Flags
  7ffe::4             00:00:13  00:04:06 Yes   R
```

Part 5: Access and Security



- Chapter 49 Access Control Lists Introduction
- Chapter 50 IPv4 Access Control List (ACL) Commands
- Chapter 51 IPv6 Access Control List (ACL) Commands
- Chapter 52 Quality of Service (QoS)
- Chapter 53 QoS Commands
- Chapter 54 802.1X Configuration
- Chapter 55 802.1X Commands
- Chapter 56 Authentication Configuration
- Chapter 57 Authentication Commands
- Chapter 58 AAA Introduction and Configuration
- Chapter 59 AAA Commands
- Chapter 60 RADIUS Introduction and Configuration
- Chapter 61 RADIUS Commands
- Chapter 62 Local RADIUS Server Introduction and Configuration
- Chapter 63 Local RADIUS Server Commands
- Chapter 64 Secure Shell (SSH) Introduction
- Chapter 65 Secure Shell (SSH) Configuration
- Chapter 66 Secure Shell (SSH) Commands
- Chapter 67 DHCP Snooping Introduction
- Chapter 68 DHCP Snooping Commands

Chapter 49: Access Control Lists

Introduction



Introduction.....	49.2
ACL Rules.....	49.3
ACL Source and Destination Addresses.....	49.3
ACL Reverse Masking.....	49.3
ACL Sequence Number Support.....	49.4
ACL Sequence Number Support Behavior.....	49.4
ACL Sequence Number Support Applicability.....	49.4
ACL Sequence Number Support ACL Types.....	49.5
ACL Sequence Number Support Configuration Examples.....	49.7
Classifying Your Traffic.....	49.12
Security ACLs.....	49.12
QoS ACLs.....	49.12
Profile Limitations.....	49.13
ACL Types.....	49.15
Hardware MAC ACLs.....	49.16
Hardware IP ACLs.....	49.17
Actions for Hardware ACLs.....	49.18
Applying ACLs.....	49.19
Attaching ACLs to a Port.....	49.19
Filtering with the QoS Match Filtering Commands.....	49.21
TCP Flags.....	49.21

Introduction

An Access Control List (ACL) is one filter, or a sequence of filters, that are applied to an interface to either block, pass, or when using QoS, apply priority to, packets that match the filter definitions. ACLs are used to restrict network access by hosts and devices and to limit network traffic.

An ACL contains an ordered list of filters. Each filter specifies either permit or deny and a set of conditions the packet must satisfy in order to match the filter. The meaning of permit or deny entries depends on the context in which the ACL is used - either on an inbound or an outbound interface.

When a packet is received on an interface, the switch compares fields in the packet against filters in the ACL to check whether the packet has permission to be forwarded, based on the filter properties. The first match determines whether the switch accepts or rejects the packets. If no entries match, the switch rejects the packets. If there are no restrictions, the switch forwards the packets.

Because filters in an ACL are applied sequentially and their action stops at the first match, it is very important that you apply the filters in the correct order. For example you might want to pass all traffic from VLAN 4 except for that arriving from two selected addresses A and B. Setting up a filter that first passes all traffic from VLAN 4 then denies traffic from addresses A and B will not filter out traffic from A and B if they are members VLAN 4. To ensure that the traffic from A and B is always blocked you should first apply the filter to block traffic from A and B, then apply the filter to allow all traffic from VLAN 4.

You can assign sequence numbers to filters. See [“ACL Sequence Number Support” on page 49.4](#) for more information.

Each ACL is assigned an ACL number within the range 1 to 4699. ACL numbers are grouped into ranges, where each range denotes a specific functionality. The following table shows the number ranges and functionality that your switch supports.

Table 49-1: ACL Numeric Ranges and Functionality

ACL Number Range	Function
1 to 99	IP standard ACL range ¹
100 to 199	IP extended ACL range ¹
1300 to 1999	IP standard expanded ACL range ¹
2000 to 2699	IP extended expanded ACL range ¹
3000 to 3699	Hardware IP ACL range
4000 to 4699	Hardware MAC ACL range

1. Software ACLs that use either the ranges 1-99, 100-199, 1300-1999, 2000-2699, or are named ACLs (that use the standard or extended keyword followed by a text string), are used in features such as SNMP, IGMP, BGP and OSPF.



Note The filtering principles applied to software ACLs (those in the range 1 to 2699) are different to those applied to hardware ACLs (those in the range 3000 to 4699).
Software ACLs will **deny** access unless **explicitly permitted** by an ACL action.
Hardware ACLs will **permit** access unless **explicitly denied** by an ACL action.

ACL Rules

- The source or destination address or the protocol of each packet being filtered are tested against the filters in the ACL, one condition at a time (for a permit or a deny filter).
- If a packet does not match a filter then the packet is then checked against the next filter in the ACL.
- If a packet and a filter match, the subsequent filters in the ACL are not checked and the packet is permitted or denied as specified in the matched filter.
- The first filter that the packet matches determines whether the packet is permitted or denied. After the first match, no subsequent filters are considered.
- If the ACL denies the address or protocol then the software discards the packet.
- If no filters match then the packet is dropped.
- Checking stops after the first match, so the order of the filters in the ACL is critical. The same permit or deny filter specified in a different order could result in a packet being passed in one situation and denied in another situation.
- One ACL per interface, per protocol, per direction is allowed. However, each ACL assigned per interface, per protocol, per direction may also have multiple filters.
- For inbound ACLs, a permit filter continues to process the packet after receiving it on an inbound interface, and a deny filter discards the packet.

ACL Source and Destination Addresses

Configure source addresses in ACL filters to filter packets coming **from** specified networking devices or hosts. Configure destination addresses in ACL filters to filter packets going **to** specified networking devices or hosts.

ACL Reverse Masking

ACLs uses reverse masking, also referred to as wildcard masking, to indicate to the switch whether to check or ignore corresponding IP address bits when comparing the address bits in an ACL filter to a packet being submitted to the ACL.

Reverse masking for IP address bits specify how the switch treats the corresponding IP address bits. A reverse mask is also called an inverted mask because a 1 and 0 mean the opposite of what they mean in a subnet or a network mask.

- A reverse mask bit 0 means check the corresponding bit value.
- A reverse mask bit 1 means ignore the corresponding bit value.

ACL Sequence Number Support

To help you manage ACLs you can apply sequence numbers to filters. This allows you to remove filters from named and numbered ACLs without having to reconfigure an ACL.

The ability to add sequence numbers to filters simplifies updates through the ability to position a filter within an ACL. When you add a new filter, you can specify a sequence number to position the filter in the ACL and you can also remove a current filter in an ACL by specifying a sequence number.

ACL Sequence Number Support Behavior

- If filters with no sequence numbers are applied then the first filter is assigned a sequence number of 10, and successive filters are incremented by 10. Sequence numbers are generated automatically if they are not specified at entry.
- The maximum filter sequence number is 65535. If the sequence number exceeds this maximum, the command will not be recognized and will show the error message:
`% Unrecognized command`
- If you enter a filter without a sequence number it is assigned a sequence number that is 10 greater than the last sequence number and is placed at the end of the ACL.
- If the user enters a filter that matches an already existing filter then the first filter is overwritten with the subsequent filter.
- ACL sequence numbers are re-numbered upon switch restart following a `reload` command, or after powering off and powering on the switch. ACL sequence numbers are renumbered starting from 10 and increment by 10 for each filter. See the sample output in the configuration section that follows for an illustration of this behavior. No ACL sequence number re-number command is available to perform this action.
- The ACL sequence number feature works with numbered and named standard and extended IPv4 and IPv6 access lists, plus named hardware IPv4 and IPv6 access lists
- The name of an access list can be designated as a number. Number in named ACLs must not exist within the range or designated numbered ACLs. (where <1-99> and <1300-1999> are standard numbered ACLs, <100-199> and <2000-2699> are extended numbered ACLs, <3000-3699> and <4000-4699> are hardware numbered ACLs).

ACL Sequence Number Support Applicability

The ACL sequence number support feature is available with numbered and named standard and extended IPv4 and IPv6 ACLs, and the named hardware IPv4 and IPv6 ACLs.

Numbered standard ACLs are available in the range <1-99> and <1300-1999>, which permit or deny source addresses to control packets coming from network devices or hosts, in software.

Numbered extended ACLs are available in the range <100-199> and <2000-2699>, which permit or deny source addresses and destination addresses (plus ICMP, TCP, UDP messages) to control packets coming from and going to network devices or hosts.

Named hardware IPv4 and IPv6 ACLs are available which permit or deny IP and MAC source and destination addresses plus VLAN IDs to control packets coming from and going to network device and hosts. Named hardware IPv4 and IPv6 ACLs use the ACL sequence number support feature for ACL revision.

The ACL sequence number support feature is available for use with named hardware IPv4 and IPv6 ACLs, but this feature is not available for use with the numbered hardware IPv4 ACLs.

Numbered hardware ACLs are available in the range <3000–3699>, which permit or deny IP source addresses, IP destination addresses, and VLAN IDs to control packets coming from and going to network devices and hosts, in hardware.

Numbered hardware ACLs are available in the range <4000–4699>, which permit or deny MAC source addresses, MAC destination addresses, and VLAN IDs to control packets coming from and going to network devices and hosts, in hardware.

ACL Sequence Number Support ACL Types

There is ACL sequence number support for the following types of ACLs:

ACL Type	ACL Command Syntax
IPv4 Standard Numbered ACLs	<code>access-list <1-99></code> <code>access-list <1300-1999></code>
IPv4 Extended Numbered ACLs	<code>access-list <100-199></code> <code>access-list <2000-2699></code>
IPv4 Standard Named ACLs	<code>access-list standard <name></code>
IPv4 Extended Named ACLs	<code>access-list extended <name></code>
IPv4 Hardware Named ACLs	<code>access-list hardware <name></code>
IPv6 Standard Named ACLs	<code>ipv6 access-list standard <name></code>
IPv6 Extended Named ACLs	<code>ipv6 access-list extended <name></code>
IPv6 Hardware Named ACLs	<code>ipv6 access-list <name></code>

Note that ACL sequence number support for these ACL commands is optional not required. An ACL sequence number will be added automatically, starting at 10 and incrementing by 10.

ACL Commands Without ACL Sequence Number Support

ACL sequence number support is not available for numbered hardware ACL commands:

```
access-list <3000-3699>
access-list <4000-4699>
```

Deprecated ACL Commands in Release 5.3.4

Note that `ip access-group` and `mac access-group` commands from earlier releases are now deprecated and have been replaced by the `access-group` command from release 5.3.4 onwards. The `access-group` command assigns named hardware IPv4 ACLs to interfaces.

The `ipv6 traffic-filter` command assigns named hardware IPv6 ACLs to interfaces. Note that named and numbered standard and extended IPv4 and IPv6 ACLs are not applied to switch port interfaces like named and numbered IPv4 and IPv6 hardware ACLs using these commands.

ACL Sequence Number Support ACL Sub-modes

The CLI sub-modes for sequence number filters:

1. IPv4 Standard ACL Configuration mode prompt: `awplus(config-ip-std-acl)#`

```
awplus(config)# access-list 1
awplus(config-ip-std-acl)# permit 192.168.1.0 0.0.0.255

awplus(config)# access-list 1300
awplus(config-ip-std-acl)# permit 192.168.1.0 0.0.0.255

awplus(config)# access-list standard std_name
awplus(config-ip-std-acl)# permit 192.168.1.0/24
```
2. IPv4 Extended ACL Configuration mode prompt: `awplus(config-ip-ext-acl)#`

```
awplus(config)# access-list 100
awplus(config-ip-ext-acl)# permit ip 192.168.1.0 0.0.0.255
192.168.2.0 0.0.0.255

awplus(config)# access-list 2000
awplus(config-ip-ext-acl)# permit ip 192.168.1.0 0.0.0.255
192.168.2.0 0.0.0.255

awplus(config)# access-list extended ext_name
awplus(config-ip-ext-acl)# permit ip 192.168.1.0 0.0.0.255
192.168.2.0 0.0.0.255
```
3. IPv4 Hardware ACL Configuration mode prompt: `awplus(config-ip-hw-acl)#`

```
awplus(config)# access-list hardware hw_name
awplus(config-ip-hw-acl)# permit ip 192.168.1.0 0.0.0.255
192.168.2.0 0.0.0.255
```
4. IPv6 Standard ACL Configuration mode prompt: `awplus(config-ipv6-std-acl)#`

```
awplus(config)# ipv6 access-list standard
ipv6_std_name
awplus(config-ipv6-std-acl)# permit 2001:db8::/64
```

5. IPv6 Extended ACL Configuration mode prompt: `awplus(config-ipv6-ext-acl)#`

```
awplus(config)# ipv6 access-list extended
                    ipv6_ext_name

awplus(config-ipv6-ext-acl)# permit ip 2001:db8::/64
                               2001:db9::/64
```

6. IPv6 Hardware ACL Configuration mode prompt: `awplus(config-ipv6-hw-acl)#`

```
awplus(config)# ipv6 access-list ipv6_hw_name

awplus(config-ipv6-hw-acl)# permit ip 2001:db8::/64 2001:db9::/
64
```

ACL Sequence Number Support Configuration Examples

Creating ACLs using the ACL Sub-modes.

Step 1: Create a new ACL and add a new filter

Create ACL 10 and then add a new filter to the access-list to permit all packets from the 192.168.1 subnet:

```
awplus# configure terminal

awplus(config)# access-list 10

awplus(config-ip-std-acl)# permit 192.168.1.0 0.0.0.255

awplus(config-ip-std-acl)# end

awplus# show access-list 10
```

```
Standard IP access list 10
 10 permit 192.168.1.0, wildcard bits 0.0.0.255
```

Step 2: Add another filter to the ACL

Append to, or add at the end of, ACL 10 a new filter to deny all packets from the 192.168.2 subnet:

```
awplus# configure terminal

awplus(config)# access-list 10

awplus(config-ip-std-acl)# deny 192.168.2.0 0.0.0.255

awplus(config-ip-std-acl)# end

awplus# show access-list 10
```

```
Standard IP access list 10
 10 permit 192.168.1.0, wildcard bits 0.0.0.255
 20 deny 192.168.2.0, wildcard bits 0.0.0.255
```

Note that if you add a filter to an ACL without specifying a sequence number the new filter is automatically assigned a sequence number. Sequence numbers are assigned in multiples of ten from the sequence number of the last filter.

Step 3: Insert a filter into the ACL

Insert a new filter with the sequence number 15 into ACL 10 to permit packets from the 192.168.3 subnet:

```
awplus# configure terminal
awplus(config)# access-list 10
awplus(config-ip-std-acl)# 15 permit 192.168.3.0 0.0.0.255
awplus(config-ip-std-acl)# end
awplus# show access-list 10
```

```
Standard IP access list 10
 10 permit 192.168.1.0, wildcard bits 0.0.0.255
 15 permit 192.168.3.0, wildcard bits 0.0.0.255
 20 deny 192.168.2.0, wildcard bits 0.0.0.255
```

The new filter has precedence over the filter with the sequence number 20.

Step 4: Remove a filter from the ACL by specifying a filter pattern

Remove the filter with the IP address 192.168.2 from ACL 10:

```
awplus# configure terminal
awplus(config)# access-list 10
awplus(config-ip-std-acl)# no deny 192.168.2.0 0.0.0.255
awplus(config-ip-std-acl)# end
awplus# show access-list 10
```

```
Standard IP access list 10
 10 permit 192.168.1.0, wildcard bits 0.0.0.255
 15 permit 192.168.3.0, wildcard bits 0.0.0.255
```

Step 5: Remove a filter from the ACL by specifying a sequence number

Remove the filter with the sequence number 10 from ACL 10:

```
awplus# configure terminal
awplus(config)# access-list 10
awplus(config-ip-std-acl)# no 10
awplus(config-ip-std-acl)# end
awplus# show access-list
```

```
Standard IP access list 10
 15 permit 192.168.3.0, wildcard bits 0.0.0.255
```

Creating ACLs in Global Configuration Mode

You can add new filters in **Global Configuration** mode with the [access-list \(hardware IP numbered\) command on page 50.30](#). In this mode the filters are assigned a sequence number corresponding to the order in which they are entered, i.e. the first filter entered has higher precedence in the ACL.

Step 1: Add filters with the access-list (IP) command

Add filters to ACL 10 using the access-list (IP) command:

```
awplus# configure terminal
awplus(config)# access-list 10 permit 192.168.1.0 0.0.0.255
awplus(config)# access-list 10 deny 192.168.2.0 0.0.0.255
awplus(config)# end
awplus# show access-list 10
```

```
Standard IP access list 10
 15 permit 192.168.3.0, wildcard bits 0.0.0.255
 20 permit 192.168.1.0, wildcard bits 0.0.0.255
 30 deny 192.168.2.0, wildcard bits 0.0.0.255
```

You can then enter the **IPv4 Standard ACL Configuration** mode and use the [access-list \(standard numbered\) filter command on page 50.63](#) to specify sequence numbers to reorder the filters.

Step 2: Reorder the filters

Reorder the filters in ACL 10 by specifying a sequence number for each filter. The specified sequence number will overwrite the previous sequence number assigned to the filter:

```
awplus# configure terminal
awplus(config)# access-list 10
awplus(config-ip-std-acl)# 1021 permit 192.168.1.0 0.0.0.255
awplus(config-ip-std-acl)# 3333 permit 192.168.3.0 0.0.0.255
awplus(config-ip-std-acl)# 2772 deny 192.168.2.0 0.0.0.255
awplus(config-ip-std-acl)# end
awplus# show access-list 10
```

```
Standard IP access list 10
 1021 permit 192.168.1.0, wildcard bits 0.0.0.255
 2772 deny 192.168.2.0, wildcard bits 0.0.0.255
 3333 permit 192.168.3.0, wildcard bits 0.0.0.255
```

Step 3: Copy the running-config file into the startup-config file

Copy the running-config into the file set as the current startup-config file and then reload the device. Before the reload occurs, you will receive a confirmation request saying: "reboot system? (y/n) :". When the device has reboot you can then enter **Global Configuration** mode and use the [show access-list command on page 50.69](#) command to display ACL 10:

```
awplus(config)# exit
awplus# copy running-config startup-config
awplus# reload
awplus# show access-list 10
```

```
Standard IP access list 10
 10 permit 192.168.1.0, wildcard bits 0.0.0.255
 20 deny 192.168.2.0, wildcard bits 0.0.0.255
 30 permit 192.168.3.0, wildcard bits 0.0.0.255
```

After the device has reboot the sequence numbers of the filters in the ACL have been reassigned incrementing from 10.

Display the ACL configuration details

Display the running system status and configuration details for ACLs:

```
awplus# show running-config access-list
```

```
!  
access-list 1 deny 10.1.1.0 0.0.0.255  
access-list 1 permit any  
access-list 2  
access-list 5  
access-list 10 permit 192.168.1.0 0.0.0.255  
access-list 10 deny 192.168.2.0 0.0.0.255  
access-list 10 permit 192.168.3.0 0.0.0.255  
access-list 20  
access-list 25 permit 10.1.2.0 0.0.0.255  
access-list 25 deny 192.168.1.0 0.0.0.255  
access-list 50  
access-list 95 permit any  
access-list 100  
access-list 1300  
access-list 2000  
access-list extended acl  
access-list extended my-list  
access-list extended name  
access-list extended name1  
access-list standard name3  
ipv6 access-list extended ipv6_acl  
ipv6 access-list standard ipv6_acl2  
ipv6 access-list extended my-ipv6-list  
ipv6 access-list extended my-list  
ipv6 access-list standard my-new-list  
ipv6 access-list standard name  
ipv6 access-list standard name1 deny any  
ipv6 access-list extended name5  
ipv6 access-list standard name6  
access-list hw_acl  
access-list icmp  
access-list my-hw-list  
access-list name2  
access-list name4  
!
```

For more information see [show running-config access-list command on page 7.31](#).

Classifying Your Traffic

Classification is the process of **filtering** and **marking**. Filtering involves sorting your data into appropriate traffic types. Marking involves tagging the data so that downstream ports and routers can apply appropriate service policy rules.

There are two reasons to classify data:

1. To provide network security (Security ACLs)
2. To apply service quality criteria QoS.

Security ACLs

The main application of security ACLs is to block undesired traffic. Other applications include:

- copy-to-cpu
- copy-to-mirror
- send-to-cpu

For more information on these applications see [“Actions for Hardware ACLs” on page 49.18](#)

QoS ACLs

When using ACLs though QoS, the same classification and action abilities are available, but QoS has some additional fields that it can match on (see Match Commands) and also provides the ability to perform metering, marking and remarking on packets that match the filter definitions.

For more information on applying QoS filtering, see [“Classifying your Data” on page 52.7](#).

Profile Limitations

A profile is a mask that comprises 16 bytes. Each filter item that is added to the ACL set will consume a portion of the 16 bytes. Note that Hardware ACLs and QoS filters both share this single mask. However each time a mask component is defined within the mask, it can be used in many ACLs - so it is the **number** of different components that is important.

How many filters can you create?

The following table will help you manage your ACL mask.

Protocol Component	Bytes Used in the Mask
Protocol Type	2
Ethernet format	2
VLAN ID	2
IP protocol type (TCP, UDP, etc.)	1
source IPv4 address	4
destination IPv4 address	4
source IPv6 address ¹	0
destination IPv6 address ¹	0
TCP port number	2
UDP port number	2
DSCP	1
MAC source address	6
MAC destination address	6

1. Normally any classification field, i.e. the destination MAC address, will use some of the 16 'profile bytes' that are available to classify incoming packets. For example an ACL with both source and destination MAC address fields set, will consume 12 of the 16 bytes. However the classification fields IPv6 Next Header, and IPv6 source and destination address will not consume any of these bytes, allowing greater freedom in ACL configuration options.

Example

If you make a hardware filter that matches on destination IP address and source TCP port, this adds 7 bytes to the mask:

- 1 byte for the IP protocol field (to indicate TCP)
- 4 bytes for the destination IP address
- 2 bytes for the source TCP port number.

If you now create the following (additional) hardware filters:

- A hardware filter that matches on source MAC address. This adds 6 more bytes to the mask
- A QoS class map that matches on destination IP address (4 bytes) and DSCP (1 byte). This adds 1 more byte to the mask, for the DSCP. Note that it does not add 4 more bytes for the destination IP address, because the switch already matches on that field.

- A hardware filter that matches on source IP address and source TCP port. This does not change the mask, because the switch already matches on those fields.
- A hardware filter that matches on source UDP port. This does not add any length to the mask, because it shares the same 2 bytes as the source TCP port. However, if you next make a hardware filter that matches on destination TCP or UDP port, that uses another 2 bytes.

Are there now enough bytes for your set of filters?

The mask has a maximum size of 16 bytes. When it reaches the 16-byte limit, no more classifiers can be used that would cause the mask to increase in size. The switch can still accept classifiers that use fields that have already been included in the mask.

There is no particular number of hardware filters or QoS flow groups that will cause the mask to reach its 16-byte limit - it could happen after a few filters, or you might be able to create hundreds of filters without the mask reaching its limit.

So to determine whether you will have enough filter length, look at the fields you want to filter, determine the number of bytes for each field, and sum up the total number of bytes. If that number is less than 16, there is enough filter length. Don't forget to count TCP and UDP source port as a single field, and likewise to count TCP and UDP destination port as a single field.

ACL Types

Access Control Lists (ACLs) used in AlliedWare Plus™ are separated into two different types, **Software ACLs** and **Hardware ACLs**.

Note  The filtering principles applied to software ACLs (those in the range 1 to 2699) are different to those applied to hardware ACLs (those in the range 3000 to 4699).
Software ACLs will **deny** access unless **explicitly permitted** by an ACL action.
Hardware ACLs will **permit** access unless **explicitly denied** by an ACL action.

Hardware ACLs

These ACL types are applied directly to an interface, or are used for QoS classifications. They use the following ranges:

- 3000-3699 for Hardware IP ACLs
- 4000-4699 for Hardware MAC ACLs
- named hardware IPv4 ACLs
- named hardware IPv6 ACLs

Software ACLs

These ACLs types can be either named ACLs, using the standard or extended keyword followed by a text string, or they can use the following ranges:

- 1-99
- 100-199
- 1300-1999
- 2000-2699
- named standard IPv4 ACLs
- named extended IPv4 ACLs
- named standard IPv6 ACLs
- named extended IPv6 ACLs

Software ACLs are used in features such as SNMP, PIM, IGMP, BGP and OSPF.

Hardware MAC ACLs

These are used to filter traffic based on specific source or destination MAC addresses contained within the data frames. They can be applied to ports in the form of access groups.

A MAC access list requires the following components:

- an ACL number in the range 4000-4699
- an action, permit, deny etc. See “Actions for Hardware ACLs” on page 49.18
- a source MAC address. You can use the format, HHHH.HHHH.HHHH to filter on a specific MAC address (where H is a hexadecimal number), or you can filter on any source MAC address by entering the word “any”.
- a source MAC mask. This mask determines which portion of the source MAC address header will be compared with that found in the incoming packets. The mask is configured in the format <HHHH.HHHH.HHHH> where each H is a hexadecimal number. In practice each hex number will normally be either 0 (to represent a match) or F (to represent a don't care condition). A mask is not required if the source address is specified as “any”.
- a destination MAC address. You can use the format, HHHH.HHHH.HHHH to filter on a specific MAC address (where H is a hexadecimal number), or you can filter on any destination MAC address by entering the word “any”.
- a destination MAC mask. This mask determines which portion of the destination MAC address header will be compared with that found in the incoming packets. The mask is configured in the format <HHHH.HHHH.HHHH> where each H is a hexadecimal number. In practice each hex number will normally be either 0 (to represent a match) or F (to represent a don't care condition). A mask is not required if the source address is specified as “any”.

Example To permit packets coming from a specific MAC address of 0030.841A.1234 and with any destination address:

```
awplus# configure terminal
awplus(config)# access-list 4000 permit 0030.841A.1234
0000.0000.0000 any
```

Hardware IP ACLs

These are used to filter traffic based on specific source or destination IP addresses contained within the data frames. They can be applied to ports in the form of access groups.

An IP access list requires the following components:

- an ACL number in the range 3000-3699
- an action, see [“Actions for Hardware ACLs” on page 49.18](#)
- a packet type:
 - ◀ IP: This matches any type of IP packet. A source and destination address must also be specified, although they can be "any".
 - ◀ ICMP: This matches ICMP packets. A source and destination address must also be specified, although they can be "any". An ICMP type can optionally be specified after the destination address.
 - ◀ TCP: This matches TCP packets. A source and destination address must also be specified, although they can be "any". After the source address, a source port can optionally be specified and after the destination address a destination port can optionally be specified. The port matching can be done using **eq** (equal to), **gt** (greater than), **lt** (less than), **ne** (not equal to), or **range** (for a range of ports, which requires a start port and an end port).
 - ◀ UDP: This matches UDP packets and has the same options as TCP.
 - ◀ proto: This allows any IP protocol type to be specified (e.g. 89 for OSPF). A source and destination address must be also specified, although they can be "any".

For example, to match (and permit) any type of IP packet containing a destination address of 192.168.1.1

```
awplus(config)# access-list 3000 permit ip any 192.168.1.1/32
```

To match (and permit) an ICMP packet with a source address of 192.168.x.x and an ICMP code of 4

```
awplus(config)# access-list 3001 permit icmp 192.168.0.0/16
any icmp-type 4
```

To match a TCP packet with a source address of 192.168.x.x, source port of 80 and a destination port from 100 to 150:

```
awplus(config)# access-list 3002 permit tcp 192.168.0.0/16 eq
80 any range 100 150
```

To match a UDP packet with a source address of 192.168.x.x, a destination address of 192.168.1.x, and a destination port greater than 80:

```
awplus(config)# access-list 3003 permit udp 192.168.0.0/16
192.168.1.0/24 gt 80
```

To match to any OSPF packet:

```
awplus(config)# access-list 3004 permit proto 89 any any
```

Note that an IP address mask can be specified using either of the following notations:

- "A.B.C.D/M": This is the most common; e.g. 192.168.1.0/24
- "A.B.C.D A.B.C.D": 192.168.1.1 0.0.0.0 is the same as 192.168.1.1/32 and 192.168.1.1 255.255.255.255 is the same as "any"
- "host A.B.C.D": This is the same as A.B.C.D/32

Actions for Hardware ACLs

The following actions are available for Hardware ACLs:

- deny: Discard the packet.
- permit: Allow the packet.
- copy-to-cpu: Send a copy of the packet to the CPU and forward it as well. This is the same as copy,forward in AW hardware filters.
- send-to-cpu: Send the packet to the CPU and doesn't forward it. This is the same as copy,discard in AW hardware filters.
- copy-to-mirror: Send a copy of the packet to the mirror port and forward it as well.

The action used by a QoS class-map is determined by the ACL that is attached to it. If no ACL is attached, it uses the permit action. If an ACL is not required by the class-map (for example, only matching on the VLAN) and a deny action is required, a MAC ACL should be added with any for source address and any for destination address.

The following example creates a class-map with will deny all traffic on vlan 2:

```
awplus(config)# access-list 4000 deny any any

awplus(config)# class-map cmap1

awplus(config-cmap)# match access-group 4000

awplus(config-cmap)# match vlan 2
```

The default class-map matches to all traffic and so cannot have any match or ACL commands applied to it. The action for this class-map is set via the default-action command and is permit by default. It can be changed to deny by using the following commands:

```
awplus(config)# policy-map pmap1

awplus(config-pmap)# default-action deny
```

Applying ACLs

Interface ACLs and QoS policies can both be attached to the same port. Where this is done, packets received on the port will be matched against the ACLs first.

The interface ACLs and QoS classifications are implemented by taking the first matching filter and applying the action defined for that filter. All subsequent matches in the table are then ignored. Thus, because ACLs are also matched first, if the matching ACL has a permit action, the packet is forwarded due to that rule's action and any subsequent QoS rules are bypassed.

You can also apply permit rules are using QoS.

For example, you might want to permit a source IP address of 192.168.1.x, but block everything else on 192.168.x.x.

In this case you could create both the permit and deny rules using QoS.

Attaching ACLs to a Port

An ACL is attached directly to a port (as an "Interface ACL") using the `access-group` command.

For example, to permit traffic from 192.168.1.x, but discard from 192.168.x.x:

```
awplus(config)# access-list 3000 permit ip 192.168.1.0/24
any
awplus(config)# access-list 3001 deny ip 192.168.0.0/24 any
awplus (config)# interface port1.0.1
awplus(config-if)# access-group 3000
awplus(config-if)# access-group 3001
```

The same functionality can be achieved using QoS, by attaching the ACL to a class-map, attaching the class-map to a policy-map and attaching the policy-map to a port:

Step 1: Enable QoS on the switch

```
awplus(config)# mls qos enable
```

Step 2: Create access lists

Create ACL 3000 to permit all packets from the 192.168.1 subnet:

```
awplus(config)# access-list 3000 permit ip 192.168.1.0/24 any
```

Create ACL 3001 to deny all packets from the 192.168.0 subnet:

```
awplus(config)# access-list 3001 deny ip 192.168.0.0/24 any
```

Step 3: Attach access-groups to class-maps

Attach ACL 3000 to the class-map cmap1:

```
awplus(config)# class-map cmap1
awplus(config-cmap)# match access-group 3000
awplus(config-cmap)# exit
```

Attach ACL 3001 to the same class-map (cmap2):

```
awplus(config-cmap)# match access-group 3001
awplus(config-cmap)# exit
```

Step 4: Attach class-maps to policy-maps

Attach the class-map cmap1 to policy-map pmap1:

```
awplus(config)# policy-map pmap1
awplus(config-pmap)# class cmap1
awplus(config-pmap-c)# exit
```

Add the class-map cmap2 to the policy-map pmap1:

```
awplus(config-pmap)# class cmap2
awplus(config-pmap-c)# exit
```

Return to Global Configuration mode:

```
awplus(config-pmap)# exit
```

Step 5: Add policy-maps to ports

Add policy-map pmap1 to port1.0.1:

```
awplus(config)# interface port1.0.1
awplus(config-if)# service-policy input pmap1
```

Note that multiple interface ACLs can be attached to the same port, or either type and can be interleaved. The order of matching is based on the order in which the ACLs were attached to the port. Only one ACL can be attached to a class-map, but multiple class-maps can be attached to a policy-map. Interface ACLs can be attached to the same port as a QoS policy, with the interface ACLs being matched first as described at the beginning of the Classification section.

Filtering with the QoS Match Filtering Commands

Another reason for using QoS rather than interface ACLs is that QoS provides a lot more fields on which to match. These are accessed through the match commands in config-cmap mode.

Config-cmap mode describes the fields that can be matched on. Only one of each type can be matched, with the exception of tcp-flags (see below for classification). If multiple matches are specified, they are ANDed together.

The following example shows how you can match a packet on vlan 2, that has a source IP address of 192.168.x.x and a DSCP of 12:

Create ACL 3000 to permit all packets from the 192.168 subnet:

```
awplus(config)# access-list 3000 permit ip 192.168.0.0/16
any
```

Apply ACL 3000 to the class-map cmap1 and add the matching criteria of vlan 2 and DSCP 12:

```
awplus(config)# class-map cmap1
awplus(config-cmap)# match access-group 3000
awplus(config-cmap)# match vlan 2
awplus(config-cmap)# match dscp 12
```

TCP Flags

Usually, if multiple matches of the same type are specified, the matching process will apply to the last match that you specified. For TCP flags however, the arguments are ANDed together. For example, the following series of commands will match on a packet that has ack, syn and fin set:

```
awplus(config)# class-map cmap1
awplus(config-cmap)# match tcp-flags ack
awplus(config-cmap)# match tcp-flags syn
awplus(config-cmap)# match tcp-flags fin
```

The following commands will achieve the same result:

```
awplus(config)# class-map cmap1
awplus(config-cmap)# match tcp-flags ack syn fin
```

Note that the matching is looking to see whether "any" of the specified flags are set. There is no checking for whether any of these flags are unset. Therefore the following command will match on a packet in any of the following combinations of syn and ack status flags as shown in the following table:

```
awplus(config)# class-map cmap1
awplus(config-cmap)# match tcp-flags syn
```

Syn	Ack	Match on Packet
Set	Set	Yes
Set	Unset	Yes
Unset	Set	No
Unset	Unset	No

If you want to drop packets with syn only, but not with ack and syn, the following two class-maps can be used (note that ACL 4000 is used to apply a drop action as described in [“Actions for Hardware ACLs” on page 49.18](#)):

Step 1: Create access lists

Create ACL 4000 to deny all packets with any source or destination address:

```
awplus(config)# access-list 4000 deny any any
```

Step 2: Create class-maps

Create the class-map `cmap1` and configure it to match on the TCP flags, `ack` and `syn`:

```
awplus(config)# class-map cmap1
awplus(config-cmap)# match tcp-flags ack syn
awplus(config-cmap)# exit
```

Create the class-map `cmap2` and configure it to match on the TCP flag, `syn`:

```
awplus(config)# class-map cmap2
awplus(config-cmap)# match tcp-flags syn
```

Step 3: Apply access-groups to class-maps

Apply ACL 4000 to this class-map (i.e. to `cmap2`):

```
awplus(config-cmap)# match access-group 4000
awplus(config-cmap)# exit
```

Step 4: Create policy-maps

Create the policy-map `pmap1` and associate it with `cmap1`:

```
awplus(config)# policy-map pmap1
awplus(config-pmap)# class cmap1
awplus(config-pmap-c)# exit
```

Step 5: Associate class-maps with policy-maps

Associate `cmap2` with this policy-map (`pmap1`):

```
awplus(config-pmap)# class cmap2
```

Chapter 50: IPv4 Access Control List (ACL) Commands



Introduction.....	50.2
Access List Commands and Prompts.....	50.2
Command List.....	50.4
access-group.....	50.4
access-list extended (named).....	50.6
access-list (extended numbered).....	50.15
access-list extended ICMP filter.....	50.17
access-list extended IP filter.....	50.19
access-list extended IP protocol filter.....	50.22
access-list extended TCP UDP filter.....	50.26
access-list (hardware IP numbered).....	50.29
access-list (hardware MAC numbered).....	50.39
access-list hardware (named).....	50.41
access-list hardware ICMP filter.....	50.42
access-list hardware IP protocol filter.....	50.45
access-list hardware MAC filter.....	50.51
access-list hardware TCP UDP filter.....	50.54
access-list standard (named).....	50.57
access-list (standard numbered).....	50.59
access-list standard (named) filter.....	50.61
access-list (standard numbered) filter.....	50.63
clear ip prefix-list.....	50.64
ip prefix-list.....	50.65
maximum-access-list.....	50.67
show access-group.....	50.68
show access-list.....	50.69
show interface access-group.....	50.71
show ip access-list.....	50.72
show ip prefix-list.....	50.73

Introduction

This chapter provides an alphabetical reference for the Access Control List (ACL) commands.

To apply ACLs to an LACP channel group, apply it to all the individual switch ports in the channel group. To apply ACLs to a static channel group, apply it to the static channel group itself. For more information on link aggregation see, [“Static and Dynamic \(LACP\) Link Aggregation” on page 14.16, Chapter 20, Link Aggregation Configuration](#), and [Chapter 21, Link Aggregation Commands](#).

Access List Commands and Prompts

Many of the ACL commands operate from sub-modes that are specific to particular ACL types. The table [“Access List Commands and Prompts”](#) shows the CLI prompts at which ACL commands are entered.

Table 50-1: Access List Commands and Prompts

Command Name	Command Mode	Prompt
show interface access-group	Privileged Exec	awplus#
clear ip prefix-list	Privileged Exec	awplus#
show access-group	Privileged Exec	awplus#
show access-list	Privileged Exec	awplus#
show interface access-group	Privileged Exec	awplus#
show ip access-list	Privileged Exec	awplus#
show ip prefix-list	Privileged Exec	awplus#
access-group	Global Configuration	awplus(config)#
access-list extended (named)	Global Configuration	awplus(config)#
access-list (extended numbered)	Global Configuration	awplus(config)#
access-list (hardware IP numbered)	Global Configuration	awplus(config)#
access-list (hardware MAC numbered)	Global Configuration	awplus(config)#
access-list hardware (named)	Global Configuration	awplus(config)#
access-list standard (named)	Global Configuration	awplus(config)#
access-list (standard numbered)	Global Configuration	awplus(config)#
ip prefix-list	Global Configuration	awplus(config)#
maximum-access-list	Global Configuration	awplus(config)#
access-group	Interface Configuration	awplus(config-if)#
access-list extended ICMP filter	IPv4 Extended ACL Configuration	awplus(config-ip-ext-acl)#
access-list extended IP filter	IPv4 Extended ACL Configuration	awplus(config-ip-ext-acl)#
access-list extended IP protocol filter	IPv4 Extended ACL Configuration	awplus(config-ip-ext-acl)#

Table 50-1: Access List Commands and Prompts (cont.)

Command Name	Command Mode	Prompt
access-list extended TCP UDP filter	IPv4 Extended ACL Configuration	awplus(config-ip-ext-acl)#
access-list hardware ICMP filter	IPv4 Hardware ACL Configuration	awplus(config-ip-hw-acl)#
access-list hardware IP protocol filter	IPv4 Hardware ACL Configuration	awplus(config-ip-hw-acl)#
access-list hardware MAC filter	IPv4 Hardware ACL Configuration	awplus(config-ip-hw-acl)#
access-list hardware TCP UDP filter	IPv4 Hardware ACL Configuration	awplus(config-ip-hw-acl)#
access-list standard (named) filter	IPv4 Standard ACL Configuration	awplus(config-ip-std-acl)#
access-list (standard numbered) filter	IPv4 Standard ACL Configuration	awplus(config-ip-std-acl)#

Command List

access-group

This command adds or removes a hardware-based access-list to a switch port interface. The number of hardware numbered and named access-lists that can be added to a switch port interface is determined by the available memory in hardware-based packet classification tables. This command works in both Global Configuration and Interface Configuration modes to apply hardware access-lists to all switch port interfaces or selected switch port interfaces respectively.

The **no** variant of this command removes the selected access-list from an interface.

Syntax `access-group [<3000-3699> | <4000-4699> | <hardware-access-list-name>]`
`no access-group [<3000-3699> | <4000-4699> | <hardware-access-list-name>]`

Parameter	Description
<3000-3699>	Hardware IP access-list.
<4000-4699>	Hardware MAC access-list.
<hardware-access-list-name>	The hardware access-list name.

Mode Interface Configuration or Global Configuration

Usage First create an IP access-list that applies the appropriate permit, deny requirements etc with the [access-list \(hardware IP numbered\) command on page 50.30](#), the [access-list \(hardware MAC numbered\) command on page 50.39](#) or the [access-list hardware \(named\) command on page 50.41](#). Then use this command to apply this hardware access-list to a specific port or port range. Note that this command will apply the access-list only to incoming data packets.

To apply ACLs to an LACP aggregated link, apply it to all the individual switch ports in the aggregated group. To apply ACLs to a static channel group, apply it to the static channel group itself. Do not apply an ACL to a dynamic (LACP) or static aggregated link that spans more than one switch instance ([Chapter 21, Link Aggregation Commands](#)).

Note that you cannot apply software standard and extended numbered ACLs to switch port interfaces with the access-group command. This command will only apply hardware ACLs.

Examples To add the numbered hardware access-list 3005 to all switch ports, enter the following commands::

```
awplus# configure terminal
awplus(config)# access-group 3005
```

To add the numbered hardware access-list 3005 to switch port interface `port1.0.1`, enter the following commands::

```
awplus# configure terminal
awplus(config)# interface port1.0.1
awplus(config-if)# access-group 3005
```

To add the named hardware access-list `hw-ac1` to switch port interface `port1.0.2`, enter the following commands:

```
awplus# configure terminal
awplus(config)# interface port1.0.2
awplus(config-if)# access-group hw-ac1
```

To apply an ACL to static channel group 2 containing switch ports 1.1.5 and 1.1.6, use the commands:

```
awplus# configure terminal
awplus(config)# interface port1.1.5-1.1.6
awplus(config-if)# static-channel-group 2
awplus(config)# interface sa2
awplus(config-if)# access-group 3000
```

Related Commands [access-list hardware \(named\)](#)
[access-list \(hardware IP numbered\)](#)
[access-list \(hardware MAC numbered\)](#)
[show interface access-group](#)

access-list extended (named)

This command configures an extended named access-list that permits or denies packets from specific source and destination IP addresses. You can either create an extended named ACL together with an ACL filter entry in the Global Configuration mode, or you can use the IPv4 Extended ACL Configuration mode for sequenced ACL filter entry.

The **no** variant of this command removes a specified extended named access-list.

Syntax
[icmp]

```
access-list extended <list-name>
    {deny|permit}
    icmp <source> <destination>
    [icmp-type <type-number>]
    [log]

access-list extended <list-name>

no access-list extended <list-name>
    {deny|permit}
    icmp <source> <destination>
    [icmp-type <type-number>]
    [log]

no access-list extended <list-name>
```

Table 50-2: access-list extended (named) command - icmp

Parameter	Description
<list-name>	A user-defined name for the access-list.
deny	The access-list rejects packets that match the type, source, and destination filtering specified with this command.
permit	The access-list permits packets that match the type, source, and destination filtering specified with this command.
icmp	The access-list matches only ICMP packets.
icmp-type	Matches only a specified type of ICMP messages. This is valid only when the filtering is set to match ICMP packets.

Table 50-2: access-list extended (named) command - icmp (cont.)

Parameter (cont.)	Description (cont.)
<i><source></i>	The source address of the packets. You can specify a single host, a subnet, or all sources. The following are the valid formats for specifying the source:
<i>any</i>	Matches any source IP address.
<i>host <ip-addr></i>	Matches a single source host with the IP address given by <i><ip-addr></i> in dotted decimal notation.
<i><ip-addr>/ <prefix></i>	An IPv4 address, followed by a forward slash, then the prefix length. This matches any source IP address within the specified subnet.
<i><ip-addr> <reverse-mask></i>	Alternatively, you can enter a reverse mask in dotted decimal format. For example, entering 192.168.1.1 0.0.0.255 is the same as entering 192.168.1.1/24.
<i><destination></i>	The destination address of the packets. You can specify a single host, a subnet, or all destinations. The following are the valid formats for specifying the destination:
<i>any</i>	Matches any destination IP address.
<i>host <ip-addr></i>	Matches a single destination host with the IP address given by <i><ip-addr></i> in dotted decimal notation.
<i><ip-addr>/ <prefix></i>	An IPv4 address, followed by a forward slash, then the prefix length. This matches any destination IP address within the specified subnet.
<i><ip-addr> <reverse-mask></i>	Alternatively, you can enter a reverse mask in dotted decimal format. For example, entering 192.168.1.1 0.0.0.255 is the same as entering 192.168.1.1/24.

Table 50-2: access-list extended (named) command - icmp (cont.)

Parameter (cont.)	Description (cont.)
<i><type-number></i>	The ICMP type, as defined in RFC792 and RFC950. Specify one of the following integers to create a filter for the ICMP message type:
0	Echo replies.
3	Destination unreachable messages.
4	Source quench messages.
5	Redirect (change route) messages.
8	Echo requests.
11	Time exceeded messages.
12	Parameter problem messages.
13	Timestamp requests.
14	Timestamp replies.
15	Information requests.
16	Information replies.
17	Address mask requests.
18	Address mask replies.
log	Logs the results.

```

Syntax
[tcp|udp] access-list extended <list-name>
           {deny|permit}
           {tcp|udp}
           <source>
           [eq <sourceport>|lt <sourceport>|gt <sourceport>|ne <sourceport>]
           <destination>
           [eq <destport>|lt <destport>|gt <destport>|ne <destport>]
           [log]]

access-list extended <list-name>

no access-list extended <list-name>
   {deny|permit}
   {tcp|udp}
   <source>
   [eq <sourceport>|lt <sourceport>|gt <sourceport>|ne <sourceport>]
   <destination>
   [eq <destport>|lt <destport>|gt <destport>|ne <destport>]
   [log]]

no access-list extended <list-name>

```

Table 50-3: access-list extended (named) command - tcp|udp

Parameter	Description								
<list-name>	A user-defined name for the access-list.								
deny	The access-list rejects packets that match the type, source, and destination filtering specified with this command.								
permit	The access-list permits packets that match the type, source, and destination filtering specified with this command.								
tcp	The access-list matches only TCP packets.								
udp	The access-list matches only UDP packets.								
<source>	The source address of the packets. You can specify a single host, a subnet, or all sources. The following are the valid formats for specifying the source: <table border="1" data-bbox="667 1377 1418 1865"> <tbody> <tr> <td>any</td> <td>Matches any source IP address.</td> </tr> <tr> <td>host <ip-addr></td> <td>Matches a single source host with the IP address given by <ip-addr> in dotted decimal notation.</td> </tr> <tr> <td><ip-addr>/ <prefix></td> <td>An IPv4 address, followed by a forward slash, then the prefix length. This matches any source IP address within the specified subnet.</td> </tr> <tr> <td><ip-addr> <reverse-mask></td> <td>Alternatively, you can enter a reverse mask in dotted decimal format. For example, entering 192.168.1.10.0.0.255 is the same as entering 192.168.1.1/24.</td> </tr> </tbody> </table>	any	Matches any source IP address.	host <ip-addr>	Matches a single source host with the IP address given by <ip-addr> in dotted decimal notation.	<ip-addr>/ <prefix>	An IPv4 address, followed by a forward slash, then the prefix length. This matches any source IP address within the specified subnet.	<ip-addr> <reverse-mask>	Alternatively, you can enter a reverse mask in dotted decimal format. For example, entering 192.168.1.10.0.0.255 is the same as entering 192.168.1.1/24.
any	Matches any source IP address.								
host <ip-addr>	Matches a single source host with the IP address given by <ip-addr> in dotted decimal notation.								
<ip-addr>/ <prefix>	An IPv4 address, followed by a forward slash, then the prefix length. This matches any source IP address within the specified subnet.								
<ip-addr> <reverse-mask>	Alternatively, you can enter a reverse mask in dotted decimal format. For example, entering 192.168.1.10.0.0.255 is the same as entering 192.168.1.1/24.								

Table 50-3: access-list extended (named) command - tcp|udp (cont.)

Parameter (cont.)	Description (cont.)
<i><destination></i>	The destination address of the packets. You can specify a single host, a subnet, or all destinations. The following are the valid formats for specifying the destination:
<i>any</i>	Matches any destination IP address.
<i>host <ip-addr></i>	Matches a single destination host with the IP address given by <i><ip-addr></i> in dotted decimal notation.
<i><ip-addr>/ <prefix></i>	An IPv4 address, followed by a forward slash, then the prefix length. This matches any destination IP address within the specified subnet.
<i><ip-addr> <reverse-mask></i>	Alternatively, you can enter a reverse mask in dotted decimal format. For example, entering 192.168.1.10.0.0.255 is the same as entering 192.168.1.1/24.
<i><sourceport></i>	The source port number, specified as an integer between 0 and 65535.
<i><destport></i>	The destination port number, specified as an integer between 0 and 65535.
<i>eq</i>	Matches port numbers equal to the port number specified immediately after this parameter.
<i>lt</i>	Matches port numbers less than the port number specified immediately after this parameter.
<i>gt</i>	Matches port numbers greater than the port number specified immediately after this parameter.
<i>ne</i>	Matches port numbers not equal to the port number specified immediately after this parameter.
<i>log</i>	Log the results.

```

Syntax
[proto|any|ip] access-list extended <list-name>
                {deny|permit}
                {proto <ip-protocol>|any|ip}
                {<source>}
                {<destination>}
                [log]

access-list extended <list-name>

no access-list extended <list-name>
                {deny|permit}
                {proto <ip-protocol>|any|ip}
                {<source>}
                {<destination>}
                [log]

no access-list extended <list-name>

```

Table 50-4: access-list extended (named) command - proto|ip|any

Parameter	Description
<list-name>	A user-defined name for the access-list.
deny	The access-list rejects packets that match the type, source, and destination filtering specified with this command.
permit	The access-list permits packets that match the type, source, and destination filtering specified with this command.
proto	Matches only a specified type of IP Protocol.
any	The access-list matches any type of IP packet.
ip	The access-list matches only IP packets.
<source>	The source address of the packets. You can specify a single host, a subnet, or all sources. The following are the valid formats for specifying the source: <ul style="list-style-type: none"> any Matches any source IP address. host <ip-addr> Matches a single source host with the IP address given by <ip-addr> in dotted decimal notation. <ip-addr>/<prefix> An IPv4 address, followed by a forward slash, then the prefix length. This matches any source IP address within the specified subnet. <ip-addr><reverse-mask> Alternatively, you can enter a reverse mask in dotted decimal format. For example, entering 192.168.1.1 0.0.0.255 is the same as entering 192.168.1.1/24.

Table 50-4: access-list extended (named) command - proto|ip|any (cont.)

Parameter (cont.)	Description (cont.)
<i><destination></i>	The destination address of the packets. You can specify a single host, a subnet, or all destinations. The following are the valid formats for specifying the destination:
<i>any</i>	Matches any destination IP address.
<i>host <ip-addr></i>	Matches a single destination host with the IP address given by <i><ip-addr></i> in dotted decimal notation.
<i><ip-addr>/ <prefix></i>	An IPv4 address, followed by a forward slash, then the prefix length. This matches any destination IP address within the specified subnet.
<i><ip-addr> <reverse-mask></i>	Alternatively, you can enter a reverse mask in dotted decimal format. For example, entering 192.168.1.1 0.0.0.255 is the same as entering 192.168.1.1/24.
<i>log</i>	Logs the results.

Table 50-4: access-list extended (named) command - proto|ip|any (cont.)

Parameter (cont.)	Description (cont.)
<code><ip-protocol></code>	The IP protocol number, as defined by IANA (Internet Assigned Numbers Authority www.iana.org ref: http://www.iana.org/assignments/protocol-numbers)
Protocol Number	Protocol Description [RFC Reference]
1	Internet Control Message [RFC792]
2	Internet Group Management [RFC1112]
3	Gateway-to-Gateway [RFC823]
4	IP in IP [RFC2003]
5	Stream [RFC1190] [RFC1819]
6	TCP (Transmission Control Protocol) [RFC793]
8	EGP (Exterior Gateway Protocol) [RFC888]
9	IGP (Interior Gateway Protocol) [IANA]
11	Network Voice Protocol [RFC741]
17	UDP (User Datagram Protocol) [RFC768]
20	Host monitoring [RFC869]
27	RDP (Reliable Data Protocol) [RFC908]
28	IRTP (Internet Reliable Transaction Protocol) [RFC938]
29	ISO-TP4 (ISO Transport Protocol Class 4) [RFC905]
30	Bulk Data Transfer Protocol [RFC969]
33	Datagram Congestion Control Protocol [RFC4340]
48	DSR (Dynamic Source Routing Protocol) [RFC4728]
50	ESP (Encap Security Payload) [RFC2406]
51	AH (Authentication Header) [RFC2402]
54	NARP (NBMA Address Resolution Protocol) [RFC1735]
58	ICMP for IPv6 [RFC1883]
59	No Next Header for IPv6 [RFC1883]
60	Destination Options for IPv6 [RFC1883]
88	EIGRP (Enhanced Interior Gateway Routing Protocol)
89	OSPF [RFC1583]

Table 50-4: access-list extended (named) command - proto|ip|any (cont.)

Parameter (cont.)	Description (cont.)	
<ip-protocol> (cont.)	Protocol Number	Protocol Description [RFC Reference]
	97	Ethernet-within-IP Encapsulation / RFC3378
	98	Encapsulation Header / RFC1241
	108	IP Payload Compression Protocol / RFC2393
	112	Virtual Router Redundancy Protocol / RFC3768
	134	RSVP-E2E-IGNORE / RFC3175
	135	Mobility Header / RFC3775
	136	UDPLite / RFC3828
	137	MPLS-in-IP / RFC4023
	138	MANET Protocols / RFC-ietf-manet-iana-07.txt
	139–252	Unassigned / IANA
	253	Use for experimentation and testing / RFC3692
	254	Use for experimentation and testing / RFC3692
	255	Reserved / IANA

Mode Global Configuration or Global Configuration and IPv4 Extended ACL Configuration

Usage Use this command when configuring access-list for filtering IP software packets. To enable backwards compatibility you can either create access-lists from within this command, or you can enter **access-list** followed by only the number. This latter method moves you to the IPv4 Extended ACL Configuration mode for the selected access-list number, and from here you can configure your access-lists by using the [access-list extended ICMP filter command on page 50.18](#), the [access-list extended IP filter command on page 50.20](#), and the [access-list extended IP protocol filter command on page 50.23](#).

The table *“Access List Commands and Prompts” on page 50.2* shows the prompts at which ACL commands are entered.

Note that packets must match both the source and the destination details.

Example You can either enter the extended named ACL in the Global Configuration mode together with the ACL filter entry on the same line, as in previous software releases as shown below:

```
awplus# configure terminal
awplus(config)# access-list extended TK deny tcp 2.2.2.3/24 eq
14 3.3.3.4/24 lt 12 log
```

Alternatively, you can enter the extended named ACL in Global Configuration mode before specifying the ACL filter entry in the IPv4 Extended ACL Configuration mode, as shown below:

```
awplus# configure terminal
awplus(config)# access-list extended TK
awplus(config-ip-ext-acl)# deny tcp 2.2.2.3/24 eq 14 3.3.3.4/24
lt 12 log
```

Related Commands

- [access-list extended ICMP filter](#)
- [access-list extended IP filter](#)
- [access-list extended TCP UDP filter](#)
- [show running-config](#)
- [show ip access-list](#)

access-list (extended numbered)

This command configures an extended numbered access-list that permits or denies packets from specific source and destination IP addresses. You can either create an extended numbered ACL together with an ACL filter entry in the Global Configuration mode, or you can use the IPv4 Extended ACL Configuration mode for sequenced ACL filter entry.

The **no** variant of this command removes a specified extended named access-list.

Syntax

```
access-list {<100-199>|<2000-2699>}
  {deny|permit}
  ip <source> <destination>

access-list {<100-199>|<2000-2699>}

no access-list {<100-199>|<2000-2699>}
  {deny|permit}
  ip <source> <destination>

no access-list {<100-199>|<2000-2699>}
```

Parameter	Description
<100-199>	IP extended access-list.
<2000-2699>	IP extended access-list (expanded range).
deny	Access-list rejects packets that match the source and destination filtering specified with this command.
permit	Access-list permits packets that match the source and destination filtering specified with this command.
<source>	The source address of the packets. You can specify a single host, a subnet, or all sources. The following are the valid formats for specifying the source:
any	Matches any source IP address.
host <ip-addr>	Matches a single source host with the IP address given by <ip-addr> in dotted decimal notation.
<ip-addr>/<prefix>	An IPv4 address, followed by a forward slash, then the prefix length. This matches any source IP address within the specified subnet.
<ip-addr><reverse-mask>	Alternatively, you can enter a reverse mask in dotted decimal format. For example, entering 192.168.1.1 0.0.0.255 is the same as entering 192.168.1.1/24.

Parameter (cont.)	Description (cont.)
<code><destination></code>	The destination address of the packets. You can specify a single host, a subnet, or all destinations. The following are the valid formats for specifying the destination:
<code>any</code>	Matches any destination IP address.
<code>host <ip-addr></code>	Matches a single destination host with the IP address given by <code><ip-addr></code> in dotted decimal notation.
<code><ip-addr>/ <prefix></code>	An IPv4 address, followed by a forward slash, then the prefix length. This matches any destination IP address within the specified subnet.
<code><ip-addr> <reverse-mask></code>	Alternatively, you can enter a reverse mask in dotted decimal format. For example, entering <code>192.168.1.1 0.0.0.255</code> is the same as entering <code>192.168.1.1/24</code> .

Mode Global Configuration or Global Configuration and IPv4 Extended ACL Configuration

Usage Use this command when configuring access-list for filtering IP software packets. To enable backwards compatibility you can either create access-lists from within this command, or you can enter **access-list** followed by only the number. This latter method moves you to the IPv4 Extended ACL Configuration mode for the selected access-list number, and from here you can configure your access-lists by using the [access-list extended ICMP filter command on page 50.18](#), the [access-list extended IP filter command on page 50.20](#), and the [access-list extended IP protocol filter command on page 50.23](#).

The table [“Access List Commands and Prompts” on page 50.2](#) shows the prompts at which ACL commands are entered.

Note that packets must match both the source and the destination details.

Example You can either enter the extended named ACL in the Global Configuration mode together with the ACL filter entry on the same line, as in previous software releases as shown below:

```
awplus# configure terminal
```

```
awplus(config)# access-list 101 deny ip 172.16.10.0 0.0.0.255 any
```

Alternatively, you can enter the extended named ACL in Global Configuration mode before specifying the ACL filter entry in the IPv4 Extended ACL Configuration mode, as shown below:

```
awplus# configure terminal
```

```
awplus(config)# access-list 101
```

```
awplus(config-ip-ext-acl)# deny ip 172.16.10.0 0.0.0.255 any
```

Related Commands

- [access-list extended ICMP filter](#)
- [access-list extended IP filter](#)
- [access-list extended TCP UDP filter](#)
- [show running-config](#)
- [show ip access-list](#)

access-list extended ICMP filter

Use this ACL filter to add a new ICMP filter entry to the current extended access-list. If the sequence number is specified, the new filter is inserted at the specified location. Otherwise, the new filter is added at the end of the access-list.

The **no** variant of this command removes an ICMP filter entry from the current extended access-list. You can specify the ICMP filter entry for removal by entering either its sequence number (i.e. **no 10**), or by entering its ICMP filter profile without specifying its sequence number.

Note that the sequence number can be found by running the command, the [show access-list command on page 50.69](#).

Syntax [icmp]

```
[<sequence-number>] {deny|permit}
  icmp <source> <destination>
  [icmp-type <icmp-value>] [log]

no {deny|permit} icmp <source> <destination>
  [icmp-type <icmp-value>] [log]

no <sequence-number>
```

Parameter	Description				
<i><sequence-number></i>	<1-65535> The sequence number for the filter entry of the selected access control list.				
deny	Access-list rejects packets that match the source and destination filtering specified with this command.				
permit	Access-list permits packets that match the source and destination filtering specified with this command.				
icmp	ICMP packet type.				
<i><source></i>	The source address of the packets. You can specify a single host, a subnet, or all sources. The following are the valid formats for specifying the source: <table border="1" data-bbox="667 1420 1423 1621"> <tbody> <tr> <td><i><ip-addr>/<prefix></i></td> <td>An IPv4 address, followed by a forward slash, then the prefix length. This matches any source IP address within the specified subnet.</td> </tr> <tr> <td>any</td> <td>Matches any source IP address.</td> </tr> </tbody> </table>	<i><ip-addr>/<prefix></i>	An IPv4 address, followed by a forward slash, then the prefix length. This matches any source IP address within the specified subnet.	any	Matches any source IP address.
<i><ip-addr>/<prefix></i>	An IPv4 address, followed by a forward slash, then the prefix length. This matches any source IP address within the specified subnet.				
any	Matches any source IP address.				
<i><destination></i>	The destination address of the packets. You can specify a single host, a subnet, or all destinations. The following are the valid formats for specifying the destination: <table border="1" data-bbox="667 1742 1423 1944"> <tbody> <tr> <td><i><ip-addr>/<prefix></i></td> <td>An IPv4 address, followed by a forward slash, then the prefix length. This matches any destination IP address within the specified subnet.</td> </tr> <tr> <td>any</td> <td>Matches any destination IP address.</td> </tr> </tbody> </table>	<i><ip-addr>/<prefix></i>	An IPv4 address, followed by a forward slash, then the prefix length. This matches any destination IP address within the specified subnet.	any	Matches any destination IP address.
<i><ip-addr>/<prefix></i>	An IPv4 address, followed by a forward slash, then the prefix length. This matches any destination IP address within the specified subnet.				
any	Matches any destination IP address.				
icmp-type	The ICMP type.				

Parameter (cont.)	Description (cont.)
<code><icmp-value></code>	The value of the ICMP type.
<code>log</code>	Log the results.

Mode IPv4 Extended ACL Configuration

Usage An ACL can be configured with multiple ACL filters using sequence numbers. If the sequence number is omitted, the next available multiple of 10 will be used as the sequence number for the new filter. A new ACL filter can be inserted into the middle of an existing list by specifying the appropriate sequence number.

Note  The access control list being configured is selected by running the [access-list \(extended numbered\) command on page 50.16](#) or the [access-list extended \(named\) command on page 50.6](#), with the required access control list number, or name - but with no further parameters selected.

Examples To add a new entry in access-list called `my-list` that will reject ICMP packets from 10.0.0.1 to 192.168.1.1, use the commands:

```
awplus# configure terminal
awplus(config)# access-list extended my-list
awplus(config-ip-ext-acl)# deny icmp 10.0.0.1/32 192.168.1.1/32
```

Use the following commands to add a new filter at sequence number 5 position of the access-list called `my-list`. The filter will accept the ICMP type 8 packets from 10.1.1.0/24 network, to 192.168.1.0 network:

```
awplus# configure terminal
awplus(config)# access-list extended my-list
awplus(config-ip-ext-acl)# 5 permit icmp 10.1.1.0/24
192.168.1.0/24 icmp-type 8
```

Related Commands [access-list hardware \(named\)](#)
[show running-config](#)
[show ip access-list](#)

access-list extended IP filter

Use this ACL filter to add a new IP filter entry to the current extended access-list. If the sequence number is specified, the new filter is inserted at the specified location. Otherwise, the new filter is added at the end of the access-list.

The **no** variant of this command removes an IP filter entry from the current extended access-list. You can specify the IP filter entry for removal by entering either its sequence number (i.e. `no 10`), or by entering its IP filter profile without specifying its sequence number.

Note that the sequence number can be found by running the command, the [show access-list command on page 50.69](#).

Syntax [**ip**]

```
[<sequence-number>] {deny|permit} ip <source> <destination>
no {deny|permit} ip <source> <destination>
no <sequence-number>
```

Parameter	Description						
<code><sequence-number></code>	<code><1-65535></code> The sequence number for the filter entry of the selected access control list.						
<code>deny</code>	Access-list rejects packets that match the source and destination filtering specified with this command.						
<code>permit</code>	Access-list permits packets that match the source and destination filtering specified with this command.						
<code><source></code>	The source address of the packets. You can specify a single host, a subnet, or all sources. The following are the valid formats for specifying the source: <table border="1" data-bbox="657 1243 1425 1556"> <tbody> <tr> <td><code>any</code></td> <td>Matches any source IP address.</td> </tr> <tr> <td><code>host <ip-addr></code></td> <td>Matches a single source host with the IP address given by <code><ip-addr></code> in dotted decimal notation.</td> </tr> <tr> <td><code><ip-addr> <reverse-mask></code></td> <td>Alternatively, enter an IPv4 address followed by a reverse mask in dotted decimal format. For example, enter <code>192.168.1.1 0.0.0.255</code></td> </tr> </tbody> </table>	<code>any</code>	Matches any source IP address.	<code>host <ip-addr></code>	Matches a single source host with the IP address given by <code><ip-addr></code> in dotted decimal notation.	<code><ip-addr> <reverse-mask></code>	Alternatively, enter an IPv4 address followed by a reverse mask in dotted decimal format. For example, enter <code>192.168.1.1 0.0.0.255</code>
<code>any</code>	Matches any source IP address.						
<code>host <ip-addr></code>	Matches a single source host with the IP address given by <code><ip-addr></code> in dotted decimal notation.						
<code><ip-addr> <reverse-mask></code>	Alternatively, enter an IPv4 address followed by a reverse mask in dotted decimal format. For example, enter <code>192.168.1.1 0.0.0.255</code>						
<code><destination></code>	The destination address of the packets. You can specify a single host, a subnet, or all destinations. The following are the valid formats for specifying the destination: <table border="1" data-bbox="657 1691 1425 2004"> <tbody> <tr> <td><code>any</code></td> <td>Matches any destination IP address.</td> </tr> <tr> <td><code>host <ip-addr></code></td> <td>Matches a single destination host with the IP address given by <code><ip-addr></code> in dotted decimal notation.</td> </tr> <tr> <td><code><ip-addr> <reverse-mask></code></td> <td>Alternatively, enter an IPv4 address followed by a reverse mask in dotted decimal format. For example, enter <code>192.168.1.1 0.0.0.255</code>.</td> </tr> </tbody> </table>	<code>any</code>	Matches any destination IP address.	<code>host <ip-addr></code>	Matches a single destination host with the IP address given by <code><ip-addr></code> in dotted decimal notation.	<code><ip-addr> <reverse-mask></code>	Alternatively, enter an IPv4 address followed by a reverse mask in dotted decimal format. For example, enter <code>192.168.1.1 0.0.0.255</code> .
<code>any</code>	Matches any destination IP address.						
<code>host <ip-addr></code>	Matches a single destination host with the IP address given by <code><ip-addr></code> in dotted decimal notation.						
<code><ip-addr> <reverse-mask></code>	Alternatively, enter an IPv4 address followed by a reverse mask in dotted decimal format. For example, enter <code>192.168.1.1 0.0.0.255</code> .						

Mode Extended ACL Configuration

Usage An ACL can be configured with multiple ACL filters using sequence numbers. If the sequence number is omitted, the next available multiple of 10 will be used as the sequence number for the new filter. A new ACL filter can be inserted into the middle of an existing list by specifying the appropriate sequence number.

 **Note** The access control list being configured is selected by running the [access-list \(extended numbered\) command on page 50.16](#) or the [access-list extended \(named\) command on page 50.6](#), with the required access control list number, or name - but with no further parameters selected.

Example Use the following commands to enter the IPv4 Extended ACL Configuration mode and define a numbered extended access-list 101:

```
awplus# configure terminal
awplus(config)# access-list 101
awplus(config-ip-ext-acl)#
```

Use the following commands to add a new entry to the numbered extended access-list 101 that will reject packets from 10.0.0.1 to 192.168.1.1:

```
awplus(config-ip-ext-acl)# deny ip host 10.0.0.1 host
192.168.1.1
awplus(config-ip-ext-acl)# 20 permit ip any any
```

Example Use the following commands to enter the IPv4 Extended ACL Configuration mode and define a named access-list called `my-acl`:

```
awplus# configure terminal
awplus(config)# access-list extended my-acl
awplus(config-ip-ext-acl)#
```

Use the following commands to add a new entry to the named access-list `my-acl` that will reject packets from 10.0.0.1 to 192.168.1.1:

```
awplus(config-ip-ext-acl)# deny ip host 10.0.0.1 host
192.168.1.1
awplus(config-ip-ext-acl)# 20 permit ip any any
```

Example Use the following commands to remove the access-list filter entry with sequence number 20 from extended numbered access-list 101.

```
awplus# configure terminal
awplus(config)# access-list 101
awplus(config-ip-ext-acl)# no 20
```

Example Use the following commands to remove the access-list filter entry with sequence number 20 from extended named access-list `my-acl`:

```
awplus# configure terminal
awplus(config)# access-list extended my-acl
awplus(config-ip-ext-acl)# no 20
```

Related Commands

- access-list extended (named)
- access-list (extended numbered)
- show running-config
- show ip access-list

access-list extended IP protocol filter

Use this ACL filter to add a new IP protocol type filter entry to the current extended access-list. If the sequence number is specified, the new filter is inserted at the specified location. Otherwise, the new filter is added at the end of the access-list.

The **no** variant of this command removes an IP protocol filter entry from the current extended access-list. You can specify the IP filter entry for removal by entering either its sequence number (i.e. **no 10**), or by entering its IP filter profile without specifying its sequence number.

Note that the sequence number can be found by running the command, the [show access-list command on page 50.69](#).

Syntax [proto]

```
[<sequence-number>] {deny|permit} proto <ip-protocol>
    <source> <destination> [log]
```

```
no {deny|permit} proto <ip-protocol> <source> <destination> [log]
```

```
no <sequence-number>
```

Parameter	Description																				
<sequence-number>	<1-65535> The sequence number for the filter entry of the selected access control list.																				
deny	Access-list rejects packets that match the source and destination filtering specified with this command.																				
permit	Access-list permits packets that match the source and destination filtering specified with this command.																				
proto <ip-protocol>	The IP Protocol type specified by its protocol number <1-255>.																				
<ip-protocol>	The IP protocol number, as defined by IANA (Internet Assigned Numbers Authority www.iana.org ref: http://www.iana.org/assignments/protocol-numbers)																				
	<table border="1"> <thead> <tr> <th>Protocol Number</th> <th>Protocol Description [RFC Reference]</th> </tr> </thead> <tbody> <tr> <td>1</td> <td>Internet Control Message [RFC792]</td> </tr> <tr> <td>2</td> <td>Internet Group Management [RFC1112]</td> </tr> <tr> <td>3</td> <td>Gateway-to-Gateway [RFC823]</td> </tr> <tr> <td>4</td> <td>IP in IP [RFC2003]</td> </tr> <tr> <td>5</td> <td>Stream [RFC1190] [RFC1819]</td> </tr> <tr> <td>6</td> <td>TCP (Transmission Control Protocol) [RFC793]</td> </tr> <tr> <td>8</td> <td>EGP (Exterior Gateway Protocol) [RFC888]</td> </tr> <tr> <td>9</td> <td>IGP (Interior Gateway Protocol) [IANA]</td> </tr> <tr> <td>11</td> <td>Network Voice Protocol [RFC741]</td> </tr> </tbody> </table>	Protocol Number	Protocol Description [RFC Reference]	1	Internet Control Message [RFC792]	2	Internet Group Management [RFC1112]	3	Gateway-to-Gateway [RFC823]	4	IP in IP [RFC2003]	5	Stream [RFC1190] [RFC1819]	6	TCP (Transmission Control Protocol) [RFC793]	8	EGP (Exterior Gateway Protocol) [RFC888]	9	IGP (Interior Gateway Protocol) [IANA]	11	Network Voice Protocol [RFC741]
Protocol Number	Protocol Description [RFC Reference]																				
1	Internet Control Message [RFC792]																				
2	Internet Group Management [RFC1112]																				
3	Gateway-to-Gateway [RFC823]																				
4	IP in IP [RFC2003]																				
5	Stream [RFC1190] [RFC1819]																				
6	TCP (Transmission Control Protocol) [RFC793]																				
8	EGP (Exterior Gateway Protocol) [RFC888]																				
9	IGP (Interior Gateway Protocol) [IANA]																				
11	Network Voice Protocol [RFC741]																				

Parameter (cont.)	Description (cont.)
<i><ip-protocol></i> (cont.)	17 UDP (User Datagram Protocol) [RFC768]
	20 Host monitoring [RFC869]
	27 RDP (Reliable Data Protocol) [RFC908]
	28 IRTP (Internet Reliable Transaction Protocol) [RFC938]
	29 ISO-TP4 (ISO Transport Protocol Class 4) [RFC905]
	30 Bulk Data Transfer Protocol [RFC969]
	33 DCCP (Datagram Congestion Control Protocol) [RFC4340]
	48 DSR (Dynamic Source Routing Protocol) [RFC4728]
	50 ESP (Encap Security Payload) [RFC2406]
	51 AH (Authentication Header) [RFC2402]
	54 NARP (NBMA Address Resolution Protocol) [RFC1735]
	58 ICMP for IPv6 [RFC1883]
	59 No Next Header for IPv6 [RFC1883]
	60 Destination Options for IPv6 [RFC1883]
	88 EIGRP (Enhanced Interior Gateway Routing Protocol)
	89 OSPFIGP [RFC1583]
	97 Ethernet-within-IP Encapsulation / RFC3378
	98 Encapsulation Header / RFC1241
	108 IP Payload Compression Protocol / RFC2393
	112 Virtual Router Redundancy Protocol / RFC3768
134 RSVP-E2E-IGNORE / RFC3175	
135 Mobility Header / RFC3775	
136 UDPLite / RFC3828	
137 MPLS-in-IP / RFC4023	

Parameter (cont.)	Description (cont.)	
<i><ip-protocol></i> (cont.)	138	MANET Protocols / RFC-ietf-manet-iana-07.txt
	139-252	Unassigned / IANA
	253	Use for experimentation and testing / RFC3692
	254	Use for experimentation and testing / RFC3692
	255	Reserved / IANA
<i><source></i>	The source address of the packets. You can specify a single host, a subnet, or all sources. The following are the valid formats for specifying the source:	
	<i><ip-addr>/ <prefix></i>	An IPv4 address, followed by a forward slash, then the prefix length. This matches any source IP address within the specified subnet.
	any	Matches any source IP address.
<i><destination></i>	The destination address of the packets. You can specify a single host, a subnet, or all destinations. The following are the valid formats for specifying the destination:	
	<i><ip-addr>/ <prefix></i>	An IPv4 address, followed by a forward slash, then the prefix length. This matches any destination IP address within the specified subnet.
	any	Matches any destination IP address.
log	Log the results.	

Mode IPv4 Extended ACL Configuration

Usage An ACL can be configured with multiple ACL filters using sequence numbers. If the sequence number is omitted, the next available multiple of 10 will be used as the sequence number for the new filter. A new ACL filter can be inserted into the middle of an existing list by specifying the appropriate sequence number.

Note  The access control list being configured is selected by running the [access-list \(extended numbered\) command on page 50.16](#) or the [access-list extended \(named\) command on page 50.6](#), with the required access control list number, or name - but with no further parameters selected.

Example Use the following commands to add a new access-list filter entry to the access-list named `my-list` that will reject IP packets from source address `10.10.1.1/32` to destination address `192.68.1.1/32`:

```
awplus# configure terminal
awplus(config)# access-list extended my-list
awplus(config-ip-ext-acl)# deny ip 10.10.1.1/32 192.168.1.1/32
```

Example Use the following commands to add a new access-list filter entry at sequence position 5 in the access-list named `my-list` that will accept packets from source address `10.10.1.1/24` to destination address `192.68.1.1/24`:

```
awplus# configure terminal
awplus(config)# access-list extended my-list
awplus(config-ip-ext-acl)# 5 permit ip 10.10.1.1/24 192.168.1.1/24
```

Related Commands [access-list extended \(named\)](#)
[access-list \(extended numbered\)](#)
[show running-config](#)
[show ip access-list](#)

access-list extended TCP UDP filter

Use this ACL filter to add a new TCP or UDP filter entry to the current extended access-list. If the sequence number is specified, the new filter is inserted at the specified location. Otherwise, the new filter is added at the end of the access-list.

The **no** variant of this command removes a TCP or UDP filter entry from the current extended access-list. You can specify the TCP or UDP filter entry for removal by entering either its sequence number (i.e. **no 10**), or by entering its TCP or UDP filter profile without specifying its sequence number.

Note that the sequence number can be found by running the command, the [show access-list command on page 50.69](#).

Syntax [tcp|udp]

```
[<sequence-number>] {deny|permit} {tcp|udp}
    <source>
    {eq <sourceport>|lt <sourceport>|gt <sourceport>|ne <sourceport>}
    <destination>
    [eq <destport>|lt <destport>|gt <destport>|ne <destport>]
    [log]

no {deny|permit} {tcp|udp}
    <source>
    {eq <sourceport>|lt <sourceport>|gt <sourceport>|ne <sourceport>}
    <destination>
    [eq <destport>|lt <destport>|gt <destport>|ne <destport>]
    [log]

no <sequence-number>
```

Parameter	Description				
<sequence-number>	<1-65535> The sequence number for the filter entry of the selected access control list.				
deny	Access-list rejects packets that match the source and destination filtering specified with this command.				
permit	Access-list permits packets that match the source and destination filtering specified with this command.				
tcp	The access-list matches only TCP packets.				
udp	The access-list matches only UDP packets.				
<source>	The source address of the packets. You can specify a single host, a subnet, or all sources. The following are the valid formats for specifying the source: <table border="1" data-bbox="667 1686 1415 1892"> <tbody> <tr> <td><ip-addr>/<prefix></td> <td>An IPv4 address, followed by a forward slash, then the prefix length. This matches any source IP address within the specified subnet.</td> </tr> <tr> <td>any</td> <td>Matches any source IP address.</td> </tr> </tbody> </table>	<ip-addr>/<prefix>	An IPv4 address, followed by a forward slash, then the prefix length. This matches any source IP address within the specified subnet.	any	Matches any source IP address.
<ip-addr>/<prefix>	An IPv4 address, followed by a forward slash, then the prefix length. This matches any source IP address within the specified subnet.				
any	Matches any source IP address.				
<sourceport>	The source port number, specified as an integer between 0 and 65535.				

Parameter (cont.)	Description (cont.)
<code><destination></code>	The destination address of the packets. You can specify a single host, a subnet, or all destinations. The following are the valid formats for specifying the destination:
<code><ip-addr>/ <prefix></code>	An IPv4 address, followed by a forward slash, then the prefix length. This matches any destination IP address within the specified subnet.
<code>any</code>	Matches any destination IP address.
<code><destport></code>	The destination port number, specified as an integer between 0 and 65535.
<code>eq</code>	Matches port numbers equal to the port number specified immediately after this parameter.
<code>lt</code>	Matches port numbers less than the port number specified immediately after this parameter.
<code>gt</code>	Matches port numbers greater than the port number specified immediately after this parameter.
<code>ne</code>	Matches port numbers not equal to the port number specified immediately after this parameter.
<code>log</code>	Log the results.

Mode IPv4 Extended ACL Configuration

Usage An ACL can be configured with multiple ACL filters using sequence numbers. If the sequence number is omitted, the next available multiple of 10 will be used as the sequence number for the new filter. A new ACL filter can be inserted into the middle of an existing list by specifying the appropriate sequence number.



Note The access control list being configured is selected by running the [access-list \(extended numbered\) command on page 50.16](#) or the [access-list extended \(named\) command on page 50.6](#), with the required access control list number, or name - but with no further parameters selected.

Example To add a new entry to the access-list named `my-list` that will reject TCP packets from 10.0.0.1 on TCP port 10 to 192.168.1.1 on TCP port 20, use the commands:

```
awplus# configure terminal
awplus(config)# access-list extended my-list
awplus(config-ip-ext-acl)# deny tcp 10.0.0.1/32 eq 10
                             192.168.1.1/32 eq 20
```

Example To insert a new entry with sequence number 5 of the access-list named `my-list` that will accept UDP packets from 10.1.1.0/24 network to 192.168.1.0/24 network on UDP port 80, use the commands:

```
awplus# configure terminal
awplus(config)# access-list extended my-list
awplus(config-ip-ext-acl)# 5 permit udp 10.1.1.0/24
                             192.168.1.0/24 eq 80
```

Related Commands [access-list extended \(named\)](#)
[access-list \(extended numbered\)](#)
[show running-config](#)
[show ip access-list](#)

access-list (hardware IP numbered)

This command creates an access-list for use with hardware classification, such as QoS. The access-list will match on either TCP or UDP type packets that have the specified source and destination IP addresses and layer 4 port values or ranges. The parameter **any** may be specified if an address does not matter and the port values are optional.

The optional **vlan** parameter can be applied to match tagged (802.1q) packets.

The **no** variant of this command removes the previously specified IP hardware access-list.

Syntax [ip]

```
access-list <3000-3699>
  {deny|permit|copy-to-cpu|copy-to-mirror|send-to-cpu}
  ip <source> <destination>
  [vlan <1-4094>]
```

Syntax [icmp]

```
access-list <3000-3699>
  {deny|permit|copy-to-cpu|copy-to-mirror|send-to-cpu}
  icmp <source> <destination>
  [icmp-type <type-number>]
  [vlan <1-4094>]
```

```
no access-list <3000-3699>
```

Table 50-5: access-list (hardware IP numbered) command - ip|icmp

Parameter	Description
<3000-3699>	Hardware IP access-list number
deny	Access-list rejects packets that match the source and destination filtering specified with this command.
permit	Access-list permits packets that match the source and destination filtering specified with this command.
copy-to-cpu	Specify packets to copy to the CPU.
copy-to-mirror	Specify packets to copy to the mirror port.
send-to-cpu	Specify packets to send to the CPU.
icmp	ICMP packet.
ip	IP packet.

Table 50-5: access-list (hardware IP numbered) command - ip|icmp (cont.)

Parameter (cont.)	Description (cont.)
<i><source></i>	The source address of the packets. You can specify a single host, a subnet, or all sources. The following are the valid formats for specifying the source:
<i>any</i>	Matches any source IP address.
<i>host <ip-addr></i>	Matches a single source host with the IP address given by <i><ip-addr></i> in dotted decimal notation.
<i><ip-addr>/ <prefix></i>	An IPv4 address, followed by a forward slash, then the prefix length. This matches any source IP address within the specified subnet.
<i><ip-addr> <reverse-mask></i>	Alternatively, you can enter a reverse mask in dotted decimal format. For example, entering <i>192.168.1.1 0.0.0.255</i> is the same as entering <i>192.168.1.1/24</i> .
<i><destination></i>	The destination address of the packets. You can specify a single host, a subnet, or all destinations. The following are the valid formats for specifying the destination:
<i>any</i>	Matches any destination IP address.
<i>host <ip-addr></i>	Matches a single destination host with the IP address given by <i><ip-addr></i> in dotted decimal notation.
<i><ip-addr>/ <prefix></i>	An IPv4 address, followed by a forward slash, then the prefix length. This matches any destination IP address within the specified subnet.
<i><ip-addr> <reverse-mask></i>	Alternatively, you can enter a reverse mask in dotted decimal format. For example, entering <i>192.168.1.1 0.0.0.255</i> is the same as entering <i>192.168.1.1/24</i> .
<i>icmp-type</i>	Matches only a specified type of ICMP messages. This is valid only when the filtering is set to match ICMP packets.

Table 50-5: access-list (hardware IP numbered) command - ip|icmp (cont.)

Parameter (cont.)	Description (cont.)
<i><type-number></i>	The ICMP type, as defined in RFC792 and RFC950. Specify one of the following integers to create a filter for the ICMP message type:
0	Echo replies.
3	Destination unreachable messages.
4	Source quench messages.
5	Redirect (change route) messages.
8	Echo requests.
11	Time exceeded messages.
12	Parameter problem messages.
13	Timestamp requests.
14	Timestamp replies.
15	Information requests.
16	Information replies.
17	Address mask requests.
18	Address mask replies.
<i>vlan</i>	Specifies that the ACL will match on the ID in the packet's VLAN tag.
<i><1-4094></i>	The VLAN VID.

```

Syntax      access-list <3000-3699>
[tcp|udp]     {copy-to-cpu|copy-to-mirror|deny|permit|send-to-cpu}
                {tcp|udp}
                <source>
                [eq <sourceport>|lt <sourceport>|gt <sourceport>|ne <sourceport>|
                [range <start-range> <end-range>]
                <destination>
                [eq <destport>|lt <destport>|gt <destport>|ne <destport>]
                [range <start-range> <end-range>]

no access-list <3000-3699>

```

Table 50-6: access-list (hardware IP numbered) command - tcp|udp

Parameter	Description								
<3000-3699>	Hardware IP access-list								
copy-to-cpu	Specify packets to copy to the CPU.								
copy-to-mirror	Specify packets to copy to the mirror port.								
deny	The access-list rejects packets that match the type, source, and destination filtering specified with this command.								
permit	The access-list permits packets that match the type, source, and destination filtering specified with this command.								
send-to-cpu	Specify packets to send to the CPU.								
tcp	The access-list matches only TCP packets.								
udp	The access-list matches only UDP packets.								
<source>	The source address of the packets. You can specify a single host, a subnet, or all sources. The following are the valid formats for specifying the source: <table border="1" data-bbox="673 1265 1420 1783"> <tbody> <tr> <td>any</td> <td>Matches any source IP address.</td> </tr> <tr> <td>host <ip-addr></td> <td>Matches a single source host with the IP address given by <ip-addr> in dotted decimal notation.</td> </tr> <tr> <td><ip-addr>/<prefix></td> <td>An IPv4 address, followed by a forward slash, then the prefix length. This matches any source IP address within the specified subnet.</td> </tr> <tr> <td><ip-addr> <reverse-mask></td> <td>Alternatively, you can enter a reverse mask in dotted decimal format. For example, entering 192.168.1.1 0.0.0.255 is the same as entering 192.168.1.1/24.</td> </tr> </tbody> </table>	any	Matches any source IP address.	host <ip-addr>	Matches a single source host with the IP address given by <ip-addr> in dotted decimal notation.	<ip-addr>/<prefix>	An IPv4 address, followed by a forward slash, then the prefix length. This matches any source IP address within the specified subnet.	<ip-addr> <reverse-mask>	Alternatively, you can enter a reverse mask in dotted decimal format. For example, entering 192.168.1.1 0.0.0.255 is the same as entering 192.168.1.1/24.
any	Matches any source IP address.								
host <ip-addr>	Matches a single source host with the IP address given by <ip-addr> in dotted decimal notation.								
<ip-addr>/<prefix>	An IPv4 address, followed by a forward slash, then the prefix length. This matches any source IP address within the specified subnet.								
<ip-addr> <reverse-mask>	Alternatively, you can enter a reverse mask in dotted decimal format. For example, entering 192.168.1.1 0.0.0.255 is the same as entering 192.168.1.1/24.								

Table 50-6: access-list (hardware IP numbered) command - tcp|udp (cont.)

Parameter (cont.)	Description (cont.)
<i><destination></i>	The destination address of the packets. You can specify a single host, a subnet, or all destinations. The following are the valid formats for specifying the destination:
<i>any</i>	Matches any destination IP address.
<i>host <ip-addr></i>	Matches a single destination host with the IP address given by <i><ip-addr></i> in dotted decimal notation.
<i><ip-addr>/<prefix></i>	An IPv4 address, followed by a forward slash, then the prefix length. This matches any destination IP address within the specified subnet.
<i><ip-addr></i> <i><reverse-mask></i>	Alternatively, you can enter a reverse mask in dotted decimal format. For example, entering 192.168.1.1 0.0.0.255 is the same as entering 192.168.1.1/24.
<i><sourceport></i>	The source (TCP or UDP) port number, specified as an integer between 0 and 65535.
<i>range</i>	Range of port numbers.
<i><start-range></i>	Port number at start of range <i><0-65535></i> .
<i><end-range></i>	Port number at end of range <i><0-65535></i> .
<i><destport></i>	The destination (TCP or UDP) port number, specified as an integer between 0 and 65535.
<i>eq</i>	Matches port numbers that are equal to the port number specified immediately after this parameter.
<i>lt</i>	Matches port numbers that are less than the port number specified immediately after this parameter.
<i>gt</i>	Matches port numbers that are greater than the port number specified immediately after this parameter.
<i>ne</i>	Matches port numbers that are not equal to the port number specified immediately after this parameter.
<i>range</i>	Range of port numbers.
<i><start-range></i>	Port number at start of range <i><0-65535></i> .
<i><end-range></i>	Port number at end of range <i><0-65535></i> .
<i>vlan</i>	Specifies that the ACL will match on the ID in the packet's VLAN tag.
<i><1-4094></i>	The VLAN VID.

Syntax
[proto] access-list <3000-3699>
 {copy-to-cpu|copy-to-mirror|deny|permit|send-to-cpu}
 proto <ip-protocol> <source> <destination>

no access-list <3000-3699>

Table 50-7: access-list (hardware IP numbered) command - proto

Parameter	Description
<3000-3699>	Hardware IP access-list
copy-to-cpu	Specify packets to copy to the CPU.
copy-to-mirror	Specify packets to copy to the mirror port.
deny	Access-list rejects packets that match the source and destination filtering specified with this command.
permit	Access-list permits packets that match the source and destination filtering specified with this command.
send-to-cpu	Specify packets to send to the CPU.
<source>	The source address of the packets. You can specify a single host, a subnet, or all sources. The following are the valid formats for specifying the source:
any	Matches any source IP address.
host <ip-addr>	Matches a single source host with the IP address given by <ip-addr> in dotted decimal notation.
<ip-addr>/ <prefix>	An IPv4 address, followed by a forward slash, then the prefix length. This matches any source IP address within the specified subnet.
<ip-addr> <reverse-mask>	Alternatively, you can enter a reverse mask in dotted decimal format. For example, entering 192.168.1.1 0.0.0.255 is the same as entering 192.168.1.1/24.
<destination>	The destination address of the packets. You can specify a single host, a subnet, or all destinations. The following are the valid formats for specifying the destination:
any	Matches any destination IP address.
host <ip-addr>	Matches a single destination host with the IP address given by <ip-addr> in dotted decimal notation.
<ip-addr>/ <prefix>	An IPv4 address, followed by a forward slash, then the prefix length. This matches any destination IP address within the specified subnet.
<ip-addr> <reverse-mask>	Alternatively, you can enter a reverse mask in dotted decimal format. For example, entering 192.168.1.1 0.0.0.255 is the same as entering 192.168.1.1/24.

Table 50-7: access-list (hardware IP numbered) command - proto (cont.)

Parameter (cont.)	Description (cont.)																														
<code>proto</code>	Matches only a specified type of IP Protocol <1-255>.																														
<code><ip-protocol></code>	The IP protocol number, as defined by IANA (Internet Assigned Numbers Authority www.iana.org ref: http://www.iana.org/assignments/protocol-numbers)																														
	<table border="1"> <thead> <tr> <th>Protocol Number</th> <th>Protocol Description [RFC Reference]</th> </tr> </thead> <tbody> <tr> <td>1</td> <td>Internet Control Message [RFC792]</td> </tr> <tr> <td>2</td> <td>Internet Group Management [RFC1112]</td> </tr> <tr> <td>3</td> <td>Gateway-to-Gateway [RFC823]</td> </tr> <tr> <td>4</td> <td>IP in IP [RFC2003]</td> </tr> <tr> <td>5</td> <td>Stream [RFC1190] [RFC1819]</td> </tr> <tr> <td>6</td> <td>TCP (Transmission Control Protocol) [RFC793]</td> </tr> <tr> <td>8</td> <td>EGP (Exterior Gateway Protocol) [RFC888]</td> </tr> <tr> <td>9</td> <td>IGP (Interior Gateway Protocol) [IANA]</td> </tr> <tr> <td>11</td> <td>Network Voice Protocol [RFC741]</td> </tr> <tr> <td>17</td> <td>UDP (User Datagram Protocol) [RFC768]</td> </tr> <tr> <td>20</td> <td>Host monitoring [RFC869]</td> </tr> <tr> <td>27</td> <td>RDP (Reliable Data Protocol) [RFC908]</td> </tr> <tr> <td>28</td> <td>IRTP (Internet Reliable Transaction Protocol) [RFC938]</td> </tr> <tr> <td>29</td> <td>ISO-TP4 (ISO Transport Protocol Class 4) [RFC905]</td> </tr> </tbody> </table>	Protocol Number	Protocol Description [RFC Reference]	1	Internet Control Message [RFC792]	2	Internet Group Management [RFC1112]	3	Gateway-to-Gateway [RFC823]	4	IP in IP [RFC2003]	5	Stream [RFC1190] [RFC1819]	6	TCP (Transmission Control Protocol) [RFC793]	8	EGP (Exterior Gateway Protocol) [RFC888]	9	IGP (Interior Gateway Protocol) [IANA]	11	Network Voice Protocol [RFC741]	17	UDP (User Datagram Protocol) [RFC768]	20	Host monitoring [RFC869]	27	RDP (Reliable Data Protocol) [RFC908]	28	IRTP (Internet Reliable Transaction Protocol) [RFC938]	29	ISO-TP4 (ISO Transport Protocol Class 4) [RFC905]
Protocol Number	Protocol Description [RFC Reference]																														
1	Internet Control Message [RFC792]																														
2	Internet Group Management [RFC1112]																														
3	Gateway-to-Gateway [RFC823]																														
4	IP in IP [RFC2003]																														
5	Stream [RFC1190] [RFC1819]																														
6	TCP (Transmission Control Protocol) [RFC793]																														
8	EGP (Exterior Gateway Protocol) [RFC888]																														
9	IGP (Interior Gateway Protocol) [IANA]																														
11	Network Voice Protocol [RFC741]																														
17	UDP (User Datagram Protocol) [RFC768]																														
20	Host monitoring [RFC869]																														
27	RDP (Reliable Data Protocol) [RFC908]																														
28	IRTP (Internet Reliable Transaction Protocol) [RFC938]																														
29	ISO-TP4 (ISO Transport Protocol Class 4) [RFC905]																														

Table 50-7: access-list (hardware IP numbered) command - proto (cont.)

Parameter (cont.)	Description (cont.)
<code><ip-protocol></code>	30 Bulk Data Transfer Protocol [RFC969]
(cont.)	33 DCCP (Datagram Congestion Control Protocol) [RFC4340]
	48 DSR (Dynamic Source Routing Protocol) [RFC4728]
	50 ESP (Encap Security Payload) [RFC2406]
	51 AH (Authentication Header) [RFC2402]
	54 NARP (NBMA Address Resolution Protocol) [RFC1735]
	58 ICMP for IPv6 [RFC1883]
	59 No Next Header for IPv6 [RFC1883]
	60 Destination Options for IPv6 [RFC1883]
	88 EIGRP (Enhanced Interior Gateway Routing Protocol)
	89 OSPFIGP [RFC1583]
	97 Ethernet-within-IP Encapsulation / RFC3378
	98 Encapsulation Header / RFC1241
	108 IP Payload Compression Protocol / RFC2393
	112 Virtual Router Redundancy Protocol / RFC3768
	134 RSVP-E2E-IGNORE / RFC3175
	135 Mobility Header / RFC3775
	136 UDPLite / RFC3828
	137 MPLS-in-IP / RFC4023
	138 MANET Protocols / RFC-ietf-manet-iana-07.txt
	139-252 Unassigned / IANA
	253 Use for experimentation and testing / RFC3692
	254 Use for experimentation and testing / RFC3692
	255 Reserved / IANA
<code>vlan</code>	Specifies that the ACL will match on the ID in the packet's VLAN tag.
<code><1-4094></code>	The VLAN VID.

Mode Global Configuration

Usage This command creates an access-list for use with hardware classification, such as when applying QoS. This command can be used to match ICMP packets, IP protocols, or TCP/UDP packets.

For ICMP packets, the <3000-3699> range IP hardware access-list will match any ICMP packet that has the specified source and destination IP addresses and ICMP type.

You may apply the **any** parameter if the source or destination IP address is not important. The ICMP type is an optional parameter.

Examples Follow the below example commands to configure access-lists for ICMP, IP protocol and TCP.

ICMP Example To create an access-list that will permit ICMP packets with a source address of 192.168.1.0/24 with any destination address and an ICMP type of 5 enter the below example commands:

```
awplus# configure terminal
awplus(config)# access-list 3000 permit icmp 192.168.1.0/24
any icmp-type 5
```

To destroy the access-list with an access-list identity of 3000 enter the below example commands:

```
awplus# configure terminal
awplus(config)# no access-list 3000
```

IP Example To create an access-list that will permit any type of IP packet with a source address of 192.168.1.1 and any destination address, enter the example commands:

```
awplus# configure terminal
awplus(config)# access-list 3000 permit ip 192.168.1.1/32 any
```

To create an access-list that will deny all IGMP packets (IP protocol 2) from the 192.168.0.0 network, enter the example commands:

```
awplus# configure terminal
awplus(config)# access-list 3000 deny proto 2 192.168.0.0/16 any
```

TCP Example To create an access-list that will permit TCP packets with a destination address of 192.168.1.1, a destination port of 80 and any source address and source port, enter the example commands:

```
awplus# configure terminal
awplus(config)# access-list 3000 permit tcp any 192.168.1.1/32
eq 80
```

Related Commands [access-group](#)
[show running-config](#)
[show ip access-list](#)

access-list (hardware MAC numbered)

This command creates an access-list for use with hardware classification, such as QoS. The access-list will match on packets that have the specified source and destination MAC addresses. The parameter **any** may be specified if an address does not matter.

Optionally, the **vlan** and **inner-vlan** parameters can be matched for tagged (802.1q) packets.

The **no** variant of this command removes the specified MAC hardware filter access-list.

Syntax

```
access-list <4000-4699>
    {copy-to-cpu | copy-to-mirror | deny | permit | send-to-cpu}
    {<source-mac-address> <source-mac-mask> | any}
    {<destination-mac-address> <destination-mac-mask> | any}
    [vlan <1-4094> [inner-vlan <1-4094>]]
```

```
no access-list <4000-4699>
```

Parameter	Description
<4000-4699>	Hardware MAC access-list.
copy-to-cpu	Specify packets to copy to the CPU.
copy-to-mirror	Specify packets to copy to the mirror port.
deny	Access-list rejects packets that match the source and destination filtering.
permit	Access-list permits packets that match the source and destination filtering.
send-to-cpu	Specify packets to send to the CPU.
<source-mac-address>	The source MAC address of the packets. Enter this in the format <HHHH.HHHH.HHHH> Where each <i>H</i> is a hexadecimal number that represents a 4 bit binary number.
<source-mac-mask	The mask that will be applied to the source MAC addresses. Enter this in the format <HHHH.HHHH.HHHH> Where each <i>H</i> is a hexadecimal number that represents a 4 bit binary number. For a mask, each value will be either 0 or F. Where Hex FF = Ignore, and Hex 00 = Match.
any	Any source MAC address.
<destination-mac-address>	The destination MAC address of the packets. Enter this in the format <HHHH.HHHH.HHHH> Where each <i>H</i> is a hexadecimal number that represents a 4 bit binary number.
<destination-mac-mask>	The mask that will be applied to the destination MAC addresses. Enter this in the format <HHHH.HHHH.HHHH> Where each <i>H</i> is a hexadecimal number that represents a 4 bit binary number. For a mask, each value will be either 0 or F. Where Hex FF = Ignore, and Hex 00 = Match.
any	Any destination MAC address.
vlan	Specifies that the ACL will match on the ID in the packet's VLAN tag.

Parameter (cont.)	Description (cont.)
<1-4094>	The VLAN VID.
inner-vlan	This parameter is used within double-tagged VLANs. It is the inner VLAN tag (VID); sometimes referred to as the C-TAG (Customer VLAN TAG), where the vlan VID tag is referred to as the S-TAG (Service VLAN TAG).
<1-4094>	The inner VLAN VID.

Mode Global Configuration

Usage This command creates an access-list for use with hardware classification, such as when applying QoS. The <4000-4699> range MAC hardware access-list will match on packets that have the specified source and destination MAC addresses. You may apply the **any** parameter if the source or destination MAC host address is not important.

Examples To create an access-list that will permit packets with a MAC address of 0000.00ab.1234 and any destination address enter the below example commands:

```
awplus# configure terminal
awplus(config)# access-list 4000 permit 0000.00ab.1234
0000.0000.0000 any
```

To create an access-list that will permit packets with an initial MAC address component of 0000.00ab and any destination address, enter the below example commands:

```
awplus# configure terminal
awplus(config)# access-list 4001 permit 0000.00ab.1234
0000.0000.FFFF any
```

To destroy the access-list with an access-list identity of 4000 enter the below example commands:

```
awplus# configure terminal
awplus(config)# no access-list 4000
```

Related Commands [access-group](#)
[show running-config](#)
[show ip access-list](#)

access-list hardware (named)

This command creates a named hardware access-list that can be applied to a switch port interface. ACL filters for a named hardware ACL are created in the IPv4 Hardware ACL Configuration mode.

The **no** variant of this command removes the specified named hardware ACL.

Syntax `access-list hardware <hardware-access-list-name>`
`no access-list hardware <hardware-access-list-name>`

Parameter	Description
<code><hardware-access-list-name></code>	Specify the hardware ACL name to then define ACL filters for in the subsequent IPv4 Hardware ACL Configuration mode.

Mode Global Configuration

Usage Use this command to name a hardware ACL and enter the IPv4 Hardware ACL Configuration mode. If the named hardware ACL doesn't exist, it will be created after entry. If the named hardware ACL does exist, then you can enter IPv4 Hardware ACL Configuration mode for that existing ACL.

Entering this command with the hardware ACL name moves you to the (`config-ip-hw-acl`) prompt for the IPv4 Hardware ACL Configuration mode so you can enter ACL filters with sequence numbers. From this prompt, configure the filters for the ACL. See the ACL Introduction and Configuration chapter for complete examples of configured sequenced numbered ACLs.

See also the table "[Access List Commands and Prompts](#)" in this chapter. This table shows the relevant prompts at which ACL commands and ACL filters are entered for sequenced ACLs.

Example To create the hardware access-list named `ACL-1` and enter the IPv4 Hardware ACL Configuration mode to specify the ACL filter entry, use the commands:

```
awplus# configure terminal
awplus(config)# access-list hardware ACL-1
awplus(config-ip-hw-acl)#
```

To remove the hardware access-list named `ACL-1`, use the commands:

```
awplus# configure terminal
awplus(config)# no access-list hardware ACL-1
```

Related Commands

- `access-group`
- `access-list hardware ICMP filter`
- `access-list hardware IP protocol filter`
- `access-list hardware TCP UDP filter`
- `access-list standard (named) filter`
- `show access-group`
- `show access-list`

access-list hardware ICMP filter

Use this ACL filter to add a new ICMP filter entry to the current hardware access-list. The filter will match on any ICMP packet that has the specified source and destination IP addresses and ICMP type. The parameter **any** may be specified if an address does not matter and the ICMP type is an optional parameter. If a sequence number is specified, the new filter is inserted at the specified location. Otherwise, the new filter is added at the end of the access-list.

The optional **vlan** parameter can be applied to match tagged (802.1q) packets.

The **no** variant of this command removes an ICMP filter entry from the current hardware access-list. You can specify the ICMP filter entry for removal by entering either its sequence number (i.e. **no 10**), or by entering its ICMP filter profile without specifying its sequence number.

Note that the sequence number can be found by running the command, the [show access-list command on page 50.69](#).

Syntax
[icmp]

```
[<sequence-number>]
  {deny|permit|send-to-cpu|copy-to-cpu|copy-to-mirror}
  icmp <source> <destination>
  [icmp <icmp-value>]
  [vlan <1-4094>]

no {deny|permit|send-to-cpu|copy-to-cpu|copy-to-mirror}
  icmp <source> <destination>
  [icmp <icmp-value>]
  [vlan <1-4094>]

no <sequence-number>
```

Parameter	Description
<sequence-number>	<1-65535> The sequence number for the filter entry of the selected access control list.
deny	Access-list rejects packets that match the source and destination filtering specified with this command.
permit	Access-list permits packets that match the source and destination filtering specified with this command.
send-to-cpu	Specify packets to send to the CPU.
copy-to-cpu	Specify packets to copy to the CPU.
copy-to-mirror	Specify packets to copy to the mirror port.
icmp	ICMP packet type.

Parameter (cont.)	Description (cont.)
<code><source></code>	The source address of the packets. You can specify a single host, a subnet, or all sources. The following are the valid formats for specifying the source:
<code><ip-addr>/ <prefix></code>	An IPv4 address, followed by a forward slash, then the prefix length. This matches any source IP address within the specified subnet.
<code><ip-addr> <reverse-mask></code>	Alternatively, you can enter a reverse mask in dotted decimal format. For example, entering <code>192.168.1.1 0.0.0.255</code> is the same as entering <code>192.168.1.1/24</code> .
<code>host <ip-addr></code>	Matches a single source host with the IP address given by <code><ip-addr></code> in dotted decimal notation.
<code>any</code>	Matches any source IP address.
<code><destination></code>	The destination address of the packets. You can specify a single host, a subnet, or all destinations. The following are the valid formats for specifying the destination:
<code><ip-addr>/ <prefix></code>	An IPv4 address, followed by a forward slash, then the prefix length. This matches any destination IP address within the specified subnet.
<code><ip-addr> <reverse-mask></code>	Alternatively, you can enter a reverse mask in dotted decimal format. For example, entering <code>192.168.1.1 0.0.0.255</code> is the same as entering <code>192.168.1.1/24</code> .
<code>host <ip-addr></code>	Matches a single destination host with the IP address given by <code><ip-addr></code> in dotted decimal notation.
<code>any</code>	Matches any destination IP address.
<code>icmp-type</code>	The ICMP type.
<code><icmp-value></code>	The value of the ICMP type.
<code>vlan</code>	Specifies that the ACL will match on the ID in the packet's VLAN tag.
<code><1-4094></code>	The VLAN VID.

Mode IPv4 Hardware ACL Configuration

Usage First create a named hardware access-list that applies the appropriate permit, deny requirements etc. Then use the [access-group command on page 50.4](#) to apply this access-list to a specific port or range. Note that this command will apply the access-list only to **incoming** data packets.

An ACL can be configured with multiple ACL filters using sequence numbers. If the sequence number is omitted, the next available multiple of 10 will be used as the sequence number for the new filter. A new ACL filter can be inserted into the middle of an existing list by specifying the appropriate sequence number.

Note  You must reach the prompt `awplus(config-ip-hw-acl)#` by running the [access-list hardware \(named\) command on page 50.41](#), and entering an appropriate access-list name.

Example To add an access-list filter entry with a sequence number of 100 to the access-list named `my-list` that will permit ICMP packets with a source address of `192.168.1.0/24`, any destination address and an icmp type of 5, use the commands:

```
awplus# configure terminal
awplus(config)# access-list hardware my-list
awplus(config-ip-hw-acl)# 100 permit icmp 192.168.1.0/24 any
icmp-type 5
```

To remove an access-list filter entry with a sequence number of 100 in the access-list named `my-list`, use the commands:

```
awplus# configure terminal
awplus(config)# access-list hardware my-list
awplus(config-ip-hw-acl)# no 100
```

Related Commands [access-list hardware \(named\)](#)
[show running-config](#)
[show ip access-list](#)

access-list hardware IP protocol filter

Use this ACL filter to add an IP protocol type filter entry to the current hardware access-list. The filter will match on any IP packet that has the specified source and destination IP addresses and IP protocol type, or has the optionally specified source and destination MAC addresses. The parameter **any** may be specified if an address does not matter. If a sequence number is specified, the new filter is inserted at the specified location. Otherwise, the new filter is added at the end of the access-list.

The optional **vlan** parameter can be applied to match tagged (802.1q) packets.

The **no** variant of this command removes an IP protocol type filter entry from the current hardware access-list. You can specify the IP protocol type filter entry for removal by entering either its sequence number (i.e. **no 10**), or by entering its IP protocol type filter profile without specifying its sequence number.

Note that the sequence number can be found by running the command, the [show access-list command on page 50.69](#).

Syntax [ip|proto]

```
[<sequence-number>]
 {deny|permit|send-to-cpu|copy-to-cpu|copy-to-mirror}
 {ip|any|proto <ip-protocol>}
 {<source>|dhcp snooping} <destination>
 [mac {<mac-source-address> <mac-source-mask>|any}
 {<mac-destination-address> <mac-destination-mask>|any}]
 [vlan <1-4094>]
```

```
no {deny|permit|send-to-cpu|copy-to-cpu|copy-to-mirror}
 {ip|any|proto <ip-protocol>}
 {<source>|dhcp snooping} <destination>
 [mac {<mac-source-address> <mac-source-mask>|any}
 {<mac-destination-address> <mac-destination-mask>|any}]
 [vlan <1-4094>]
```

```
no <sequence-number>
```

Parameter	Description
<i><sequence-number></i>	<1-65535> The sequence number for the filter entry of the selected access control list.
deny	Access-list rejects packets of the type specified.
permit	Access-list allows packets of the type specified
send to cpu	Specify packets to send to the CPU.
copy to cpu	Specify packets to copy to the CPU.
copy to mirror	Specify packets to copy to the mirror port.
ip	IP packets.
any	Any packet.
proto <i><ip-protocol></i>	The IP Protocol type specified by it protocol number <1-255>.

Parameter (cont.)	Description (cont.)																																								
<code><ip-protocol></code>	The IP protocol number, as defined by IANA (Internet Assigned Numbers Authority www.iana.org ref: http://www.iana.org/assignments/protocol-numbers)																																								
	<table border="1"> <thead> <tr> <th>Protocol Number</th> <th>Protocol Description [RFC Reference]</th> </tr> </thead> <tbody> <tr> <td>1</td> <td>Internet Control Message [RFC792]</td> </tr> <tr> <td>2</td> <td>Internet Group Management [RFC1112]</td> </tr> <tr> <td>3</td> <td>Gateway-to-Gateway [RFC823]</td> </tr> <tr> <td>4</td> <td>IP in IP [RFC2003]</td> </tr> <tr> <td>5</td> <td>Stream [RFC1190] [RFC1819]</td> </tr> <tr> <td>6</td> <td>TCP (Transmission Control Protocol) [RFC793]</td> </tr> <tr> <td>8</td> <td>EGP (Exterior Gateway Protocol) [RFC888]</td> </tr> <tr> <td>9</td> <td>IGP (Interior Gateway Protocol) [IANA]</td> </tr> <tr> <td>11</td> <td>Network Voice Protocol [RFC741]</td> </tr> <tr> <td>17</td> <td>UDP (User Datagram Protocol) [RFC768]</td> </tr> <tr> <td>20</td> <td>Host monitoring [RFC869]</td> </tr> <tr> <td>27</td> <td>RDP (Reliable Data Protocol) [RFC908]</td> </tr> <tr> <td>28</td> <td>IRTP (Internet Reliable Transaction Protocol) [RFC938]</td> </tr> <tr> <td>29</td> <td>ISO-TP4 (ISO Transport Protocol Class 4) [RFC905]</td> </tr> <tr> <td>30</td> <td>Bulk Data Transfer Protocol [RFC969]</td> </tr> <tr> <td>33</td> <td>DCCP (Datagram Congestion Control Protocol) [RFC4340]</td> </tr> <tr> <td>48</td> <td>DSR (Dynamic Source Routing Protocol) [RFC4728]</td> </tr> <tr> <td>50</td> <td>ESP (Encap Security Payload) [RFC2406]</td> </tr> <tr> <td>51</td> <td>AH (Authentication Header) [RFC2402]</td> </tr> </tbody> </table>	Protocol Number	Protocol Description [RFC Reference]	1	Internet Control Message [RFC792]	2	Internet Group Management [RFC1112]	3	Gateway-to-Gateway [RFC823]	4	IP in IP [RFC2003]	5	Stream [RFC1190] [RFC1819]	6	TCP (Transmission Control Protocol) [RFC793]	8	EGP (Exterior Gateway Protocol) [RFC888]	9	IGP (Interior Gateway Protocol) [IANA]	11	Network Voice Protocol [RFC741]	17	UDP (User Datagram Protocol) [RFC768]	20	Host monitoring [RFC869]	27	RDP (Reliable Data Protocol) [RFC908]	28	IRTP (Internet Reliable Transaction Protocol) [RFC938]	29	ISO-TP4 (ISO Transport Protocol Class 4) [RFC905]	30	Bulk Data Transfer Protocol [RFC969]	33	DCCP (Datagram Congestion Control Protocol) [RFC4340]	48	DSR (Dynamic Source Routing Protocol) [RFC4728]	50	ESP (Encap Security Payload) [RFC2406]	51	AH (Authentication Header) [RFC2402]
Protocol Number	Protocol Description [RFC Reference]																																								
1	Internet Control Message [RFC792]																																								
2	Internet Group Management [RFC1112]																																								
3	Gateway-to-Gateway [RFC823]																																								
4	IP in IP [RFC2003]																																								
5	Stream [RFC1190] [RFC1819]																																								
6	TCP (Transmission Control Protocol) [RFC793]																																								
8	EGP (Exterior Gateway Protocol) [RFC888]																																								
9	IGP (Interior Gateway Protocol) [IANA]																																								
11	Network Voice Protocol [RFC741]																																								
17	UDP (User Datagram Protocol) [RFC768]																																								
20	Host monitoring [RFC869]																																								
27	RDP (Reliable Data Protocol) [RFC908]																																								
28	IRTP (Internet Reliable Transaction Protocol) [RFC938]																																								
29	ISO-TP4 (ISO Transport Protocol Class 4) [RFC905]																																								
30	Bulk Data Transfer Protocol [RFC969]																																								
33	DCCP (Datagram Congestion Control Protocol) [RFC4340]																																								
48	DSR (Dynamic Source Routing Protocol) [RFC4728]																																								
50	ESP (Encap Security Payload) [RFC2406]																																								
51	AH (Authentication Header) [RFC2402]																																								

Parameter (cont.)	Description (cont.)	
<code><ip-protocol></code> (cont.)	54	NARP (NBMA Address Resolution Protocol) [RFC1735]
	58	ICMP for IPv6 [RFC1883]
	59	No Next Header for IPv6 [RFC1883]
	60	Destination Options for IPv6 [RFC1883]
	88	EIGRP (Enhanced Interior Gateway Routing Protocol)
	89	OSPFv2 [RFC1583]
	97	Ethernet-within-IP Encapsulation / RFC3378
	98	Encapsulation Header / RFC1241
	108	IP Payload Compression Protocol / RFC2393
	112	Virtual Router Redundancy Protocol / RFC3768
	134	RSVP-E2E-IGNORE / RFC3175
	135	Mobility Header / RFC3775
	136	UDPLite / RFC3828
	137	MPLS-in-IP / RFC4023
	138	MANET Protocols / RFC-ietf-manet-iana-07.txt
	139-252	Unassigned / IANA
253	Use for experimentation and testing / RFC3692	
254	Use for experimentation and testing / RFC3692	
255	Reserved / IANA	
<code>dhcpsnooping</code>	The source address learned from the DHCP Snooping binding database.	

Parameter (cont.)	Description (cont.)
<code><source></code>	The source address of the packets. You can specify a single host, a subnet, or all sources. The following are the valid formats for specifying the source:
<code>any</code>	Matches any source IP address.
<code>host <ip-addr></code>	Matches a single source host with the IP address given by <code><ip-addr></code> in dotted decimal notation.
<code><ip-addr>/ <prefix></code>	An IPv4 address, followed by a forward slash, then the prefix length. This matches any source IP address within the specified subnet.
<code><ip-addr> <reverse-mask></code>	Alternatively, you can enter a reverse mask in dotted decimal format. For example, entering <code>192.168.1.1 0.0.0.255</code> is the same as entering <code>192.168.1.1/24</code> .
<code><destination></code>	The destination address of the packets. You can specify a single host, a subnet, or all destinations. The following are the valid formats for specifying the destination:
<code>any</code>	Matches any destination IP address.
<code>host <ip-addr></code>	Matches a single destination host with the IP address given by <code><ip-addr></code> in dotted decimal notation.
<code><ip-addr>/ <prefix></code>	An IPv4 address, followed by a forward slash, then the prefix length. This matches any destination IP address within the specified subnet.
<code><ip-addr> <reverse-mask></code>	Alternatively, you can enter a reverse mask in dotted decimal format. For example, entering <code>192.168.1.1 0.0.0.255</code> is the same as entering <code>192.168.1.1/24</code> .
<code>mac</code>	Signifies a MAC and based hardware access-list.
<code><mac-source-address></code>	The source hosts MAC address, entered in HHHH.HHHH.HHHH format.
<code><mac-source-mask></code>	The source hosts MAC wildcard mask entered in HHHH.HHHH.HHHH format. Where Hex FF = Ignore, and Hex 00 = Match.

Parameter (cont.)	Description (cont.)
any	Matches any source MAC address.
<mac-destination-address>	The destination hosts MAC address, entered in HHHH.HHHH.HHHH format.
<mac-destination-mask>	The destination hosts wildcard mask entered in HHHH.HHHH.HHHH format. Where Hex FF = Ignore, and Hex 00 = Match.
any	Matches any destination MAC address.
vlan	Specifies that the ACL will match on the ID in the packet's VLAN tag.
<1-4094>	The VLAN VID.

Mode IPv4 Hardware ACL Configuration

Usage First create a named hardware access-list that applies the appropriate permit, deny requirements etc. Then use the [access-group command on page 50.4](#) to apply this access-list to a specific port or range. Note that this command will apply the access-list only to **incoming** data packets.

An ACL can be configured with multiple ACL filters using sequence numbers. If the sequence number is omitted, the next available multiple of 10 will be used as the sequence number for the new filter. A new ACL filter can be inserted into the middle of an existing list by specifying the appropriate sequence number.

Note  The access control list being configured is selected by running the [access-list hardware \(named\) command on page 50.41](#). with the required access control list number, or name, but with no further parameters selected.

Examples To add an access-list filter entry to the access-list named `my-list` that will permit any type of IP packet with a source address of `192.168.1.1` and any destination address, use the commands:

```
awplus# configure terminal
awplus(config)# access-list hardware my-list
awplus(config-ip-hw-acl)# permit ip 192.168.1.1/32 any
```

To add an access-list filter entry to the access-list named `my-list` that will permit any type of IP packet with a source address of `192.168.1.1` and a MAC source address of `ffee.ddcc.bbaa` with any IP and MAC destination address, use the commands:

```
awplus# configure terminal
awplus(config)# access-list hardware my-list
awplus(config-ip-hw-acl)# permit ip 192.168.1.1/32 any
mac ffee.ddcc.bbaa any
```

To add an access-list filter entry to the access-list named `my-list` a filter that will deny all IGMP packets (protocol 2) from the `192.168.0.0` network with sequence number 50 in access-list, use the commands:

```
awplus# configure terminal
awplus(config)# access-list hardware my-list
awplus(config-ip-hw-acl)# 50 deny proto 2 192.168.0.0/16 any
```

To add an access-list filter entry to the access-list named `my-list` that will deny all IP packets on vlan 2, use the commands:

```
awplus# ena
awplus(config)# configure terminal
awplus(config)# access-list hardware my-list
awplus(config-ip-hw-acl)# deny ip any any vlan 2
```

Related Commands [access-list hardware \(named\)](#)
 [show running-config](#)
 [show access-list](#)

access-list hardware MAC filter

Use this ACL filter to add a MAC filter entry to the current hardware access-list. The filter will match on any IP packet that has the specified source and destination MAC addresses. The parameter **any** may be specified if an address does not matter. If a sequence number is specified, the new filter is inserted at the specified location. Otherwise, the new filter is added at the end of the access-list.

Optional parameters **vlan** and **inner-vlan** can be applied to match tagged (802.1q) packets.

The **no** variant of this command removes a MAC filter entry from the current hardware access-list. You can specify the MAC filter entry for removal by entering either its sequence number (i.e. **no 10**), or by entering its MAC filter profile without specifying its sequence number.

Note that the sequence number can be found by running the command, the [show access-list command on page 50.69](#).

Syntax
[mac]

```
[<sequence-number>]
  {deny|permit|send-to-cpu|copy-to-cpu|copy-to-mirror}
  mac {<source-mac-address> <source-mac-mask>|any}
      {<destination-mac-address> <destination-mac-mask>|any}
      [{vlan <1-4094>|inner-vlan <1-4094>}]

no {deny|permit|send-to-cpu|copy-to-cpu|copy-to-mirror}
   mac {<source-mac-address> <source-mac-mask>|any}
       {<destination-mac-address> <destination-mac-mask>|any}
       [{vlan <1-4094>|inner-vlan <1-4094>}]

no <sequence-number>
```

Parameter	Description
<sequence-number>	<1-65535> The sequence number for the filter entry of the selected access control list.
deny	Specify packets to reject.
permit	Specify packets to accept.
send-to-cpu	Specify packets to send to the CPU.
copy-to-cpu	Specify packets to copy to the CPU.
copy-to-mirror	Specify packets to copy to the CPU.
mac	MAC address.
<source-mac-address>	The source MAC address of the packets. Enter this in the format <HHHH.HHHH.HHHH> Where each H is a hexadecimal number that represents a 4 bit binary number.
<source-mac-mask>	The mask that will be applied to the source MAC addresses. Enter this in the format <HHHH.HHHH.HHHH> Where each H is a hexadecimal number that represents a 4 bit binary number. For a mask, each value will be either 0 or F. Where Hex FF = Ignore, and Hex 00 = Match.
any	Any source MAC host.

Parameter (cont.)	Description (cont.)
<code><destination-mac-address></code>	The destination MAC address of the packets. Enter this in the format <code><HHHH.HHHH.HHHH></code> Where each H is a hexadecimal number that represents a 4 bit binary number.
<code><destination-mac-mask></code>	The mask that will be applied to the destination MAC addresses. Enter this in the format <code><HHHH.HHHH.HHHH></code> Where each H is a hexadecimal number that represents a 4 bit binary number. For a mask, each value will be either 0 or F. Where Hex FF = Ignore, and Hex 00 = Match.
<code>any</code>	Any destination MAC host.
<code>vlan</code>	Specifies that the ACL will match on the ID in the packet's VLAN tag.
<code><1-4094></code>	The VLAN VID.
<code>inner-vlan</code>	This parameter is used within double-tagged VLANs. It is the inner VLAN tag (VID); sometimes referred to as the C-TAG (Customer VLAN TAG), where the vlan VID tag is referred to as the S-TAG (Service VLAN TAG).
<code><1-4094></code>	The inner VLAN VID.

Mode IPv4 Hardware ACL Configuration

Usage First create a named hardware access-list that applies the appropriate permit, deny requirements etc. Then use the [access-group command on page 50.4](#) to apply this access-list to a specific port or range. Note that this command will apply the access-list only to **incoming** data packets.

An ACL can be configured with multiple ACL filters using sequence numbers. If the sequence number is omitted, the next available multiple of 10 will be used as the sequence number for the new filter. A new ACL filter can be inserted into the middle of an existing list by specifying the appropriate sequence number

Note  The access control list being configured is selected by running the [access-list hardware \(named\) command on page 50.41](#). with the required access control list number, or name, but with no further parameters selected.

Example To add an access-list filter entry to the access-list named `my-list` that will permit packets with a source MAC address of `0000.00ab.1234` and any destination MAC address, use the commands:

```
awplus# configure terminal
awplus(config)# access-list hardware my-list
awplus(config-ip-hw-acl)# permit mac 0000.00ab.1234
                                0000.0000.0000 any
```

Example To remove an access-list filter entry that permit packets with a source MAC address of `0000.00ab.1234` and any destination MAC address, use the commands:

```
awplus# configure terminal
awplus(config)# access-list hardware my-list
awplus(config-ip-hw-acl)# no permit mac 0000.00ab.1234
                                0000.0000.0000 any
```

Related Commands [access-group](#)
[access-list hardware \(named\)](#)
[show running-config](#)

access-list hardware TCP UDP filter

Use this ACL filter to add a TCP or UDP filter entry to the current hardware access-list. The filter will match on any TCP or UDP type packet that has the specified source and destination IP addresses. The parameter **any** may be specified if an address does not matter. If a sequence number is specified, the new filter is inserted at the specified location. Otherwise, the new filter is added at the end of the access-list.

The optional **vlan** parameter can be applied to match tagged (802.1q) packets.

The **no** variant of this command removes a TCP or UDP filter entry from the current hardware access-list. You can specify the TCP or UDP filter entry for removal by entering either its sequence number (i.e. **no 10**), or by entering its TCP or UDP filter profile without specifying its sequence number.

Note that the sequence number can be found by running the command, the [show access-list command on page 50.69](#).

Syntax [tcp|udp]

```
[<sequence-number>]
 {deny|permit|send-to-cpu|copy-to-cpu|copy-to-mirror}
 {tcp|udp}
 [<source>|
 eq <sourceport>|gt <sourceport>|lt <sourceport>|
 ne <sourceport>|range <start-range> <end-range>]
 [<destination>|
 eq <destport>|gt <destport>|lt <destport>|
 ne <destport>|range <start-range> <end-range>]
 [vlan <1-4094>]

no {deny|permit|send-to-cpu|copy-to-cpu|copy-to-mirror}
 {tcp|udp}
 [<source>|
 eq <sourceport>|gt <sourceport>|lt <sourceport>|
 ne <sourceport>|range <start-range> <end-range>]
 [<destination>|
 eq <destport>|gt <destport>|lt <destport>|
 ne <destport>|range <start-range> <end-range>]
 [vlan <1-4094>]

no <sequence-number>
```

Parameter	Description
<sequence-number>	<1-65535> The sequence number for the filter entry of the selected access control list.
deny	Access-list rejects packets that match the source and destination filtering specified with this command.
permit	Access-list permits packets that match the source and destination filtering specified with this command.
send-to-cpu	Specify packets to send to the CPU.
copy-to-cpu	Specify packets to copy to the CPU.
copy-to-mirror	Specify packets to copy to the mirror port.
tcp	TCP packets.
udp	UDP packets.

Parameter (cont.)	Description (cont.)
<code><source></code>	The source address of the packets. You can specify a single host, a subnet, or all sources. The following are the valid formats for specifying the source:
<code>any</code>	Matches any source IP address.
<code>host <ip-addr></code>	Matches a single source host with the IP address given by <code><ip-addr></code> in dotted decimal notation.
<code><ip-addr>/ <prefix></code>	An IPv4 address, followed by a forward slash, then the prefix length. This matches any source IP address within the specified subnet.
<code><ip-addr> <reverse-mask></code>	Alternatively, you can enter a reverse mask in dotted decimal format. For example, entering <code>192.168.1.1 0.0.0.255</code> is the same as entering <code>192.168.1.1/24</code> .
<code><sourceport></code>	The source TCP or UDP port number, specified as an integer between 0 and 65535.
<code><destination></code>	The destination address of the packets. You can specify a single host, a subnet, or all destinations. The following are the valid formats for specifying the destination:
<code>any</code>	Matches any destination IP address.
<code>host <ip-addr></code>	Matches a single destination host with the IP address given by <code><ip-addr></code> in dotted decimal notation.
<code><ip-addr>/ <prefix></code>	An IPv4 address, followed by a forward slash, then the prefix length. This matches any destination IP address within the specified subnet.
<code><ip-addr> <reverse-mask></code>	Alternatively, you can enter a reverse mask in dotted decimal format. For example, entering <code>192.168.1.1 0.0.0.255</code> is the same as entering <code>192.168.1.1/24</code> .
<code>eq</code>	Equal to.
<code>lt</code>	Less than.
<code>gt</code>	Greater than.
<code>ne</code>	Not equal to.

Parameter (cont.)	Description (cont.)
<code><destport></code>	The source TCP or UDP port number, specified as an integer between 0 and 65535.
<code>range</code>	Specify the range of port numbers between 0 and 65535.
<code><start-range></code>	The source or destination port number at the start of the range <code><0-65535></code> .
<code><end-range></code>	The source or destination port number at the end of the range <code><0-65535></code> .
<code>vlan</code>	Specifies that the ACL will match on the ID in the packet's VLAN tag.
<code><1-4094></code>	The VLAN VID.

Mode IPv4 Hardware ACL Configuration

Usage First create a named hardware access-list that applies the appropriate permit, deny requirements etc. Then use the [access-group command on page 50.4](#) to apply this access-list to a specific port or range. Note that this command will apply the access-list only to **incoming** data packets.

An ACL can be configured with multiple ACL filters using sequence numbers. If the sequence number is omitted, the next available multiple of 10 will be used as the sequence number for the new filter. A new ACL filter can be inserted into the middle of an existing list by specifying the appropriate sequence number

Note  The access control list being configured is selected by running the [access-list hardware \(named\) command on page 50.41](#). with the required access control list number, or name, but with no further parameters selected.

Example To add an access-list filter entry to access-list named `my-hw-list` that will permit TCP packets with a destination address of `192.168.1.1`, a destination port of 80, and any source address, and source port, use the commands:

```
awplus# configure terminal
awplus(config)# access-list hardware my-hw-list
awplus(config-ip-hw-acl)# permit tcp any 192.168.1.1/32 eq 80
```

Related Commands [access-list hardware \(named\)](#)
[show running-config](#)
[show ip access-list](#)

access-list standard (named)

This command configures a standard named access-list that permits or denies packets from a specific source IP address. You can either create a standard named ACL together with an ACL filter entry in the Global Configuration mode, or you can use the IPv4 Standard ACL Configuration mode for sequenced ACL filter entry.

The **no** variant of this command removes a specified standard named access-list.

Syntax

```
access-list standard <standard-access-list-name> {deny|permit}
    <source>

access-list standard <standard-access-list-name>

no access-list standard <standard-access-list-name> {deny|permit}
    <source>

no access-list standard <standard-access-list-name>
```

Parameter	Description				
<standard-access-list-name>	Specify a name for the standard access-list.				
deny	The access-list rejects packets that match the source filtering specified with this command.				
permit	The access-list permits packets that match the source filtering specified with this command.				
<source>	The source address of the packets. You can specify a single host, a subnet, or all sources. The following are the valid formats for specifying the source: <table border="1" data-bbox="651 1189 1420 1377"> <tbody> <tr> <td><ip-addr>/<prefix></td> <td>An IPv4 address, followed by a forward slash, then the prefix length. This matches any source IP address within the specified subnet.</td> </tr> <tr> <td>any</td> <td>Matches any source IP address.</td> </tr> </tbody> </table>	<ip-addr>/<prefix>	An IPv4 address, followed by a forward slash, then the prefix length. This matches any source IP address within the specified subnet.	any	Matches any source IP address.
<ip-addr>/<prefix>	An IPv4 address, followed by a forward slash, then the prefix length. This matches any source IP address within the specified subnet.				
any	Matches any source IP address.				

Mode Global Configuration

Usage Use this command when configuring a standard named access-list for filtering IP software packets. For backwards compatibility you can either create the access-list from within this command, or you can enter this command followed by only the standard access-list name then enter **.** This latter method moves you to the IPv4 Standard ACL Configuration mode for the selected standard named access-list, and from here you can configure the deny or permit filters for this selected standard named access-list.

See the table [“Access List Commands and Prompts”](#) in this chapter which shows the prompts at which ACL commands are entered.

Examples To define a standard access-list named `my-list` and deny any packets from any source, use the commands:

```
awplus# configure terminal
awplus(config)# access-list standard my-list deny any
```

Alternatively, to define a standard access-list named `my-list` and enter the IPv4 Standard ACL Configuration mode to deny any packets from any source, use the commands:

```
awplus# configure terminal
awplus(config)# access-list standard my-list
awplus(config-ip-std-acl)# 5 deny any
```

Related Commands `access-list standard (named) filter`
`show running-config`
`show ip access-list`

access-list (standard numbered)

This command configures a standard numbered access-list that permits or denies packets from a specific source IP address. You can either create a standard numbered ACL together with an ACL filter entry in the Global Configuration mode, or you can use the IPv4 Standard ACL Configuration mode for sequenced ACL filter entry.

The **no** variant of this command removes a specified standard numbered access-list.

Syntax

```
access-list {<1-99>|<1300-1999>} {deny|permit} <source>
access-list {<1-99>|<1300-1999>}
no access-list {<1-99>|<1300-1999>} {deny|permit} <source>
no access-list {<1-99>|<1300-1999>}
```

Parameter	Description				
<1-99>	IP standard access-list.				
<1300-1999>	IP standard access-list (expanded range).				
deny	Access-list rejects packets from the specified source.				
permit	Access-list accepts packets from the specified source.				
<source>	The source address of the packets. You can specify a single host, a subnet, or all sources. The following are the valid formats for specifying the source: <table border="1" data-bbox="630 1108 1418 1308"> <tbody> <tr> <td><ip-addr> <reverse-mask></td> <td>Enter an IPv4 address followed by a reverse mask in dotted decimal format. For example, entering 192.168.1.1 0.0.0.255 is the same as entering 192.168.1.1/24.</td> </tr> <tr> <td>any</td> <td>Matches any source IP address.</td> </tr> </tbody> </table>	<ip-addr> <reverse-mask>	Enter an IPv4 address followed by a reverse mask in dotted decimal format. For example, entering 192.168.1.1 0.0.0.255 is the same as entering 192.168.1.1/24.	any	Matches any source IP address.
<ip-addr> <reverse-mask>	Enter an IPv4 address followed by a reverse mask in dotted decimal format. For example, entering 192.168.1.1 0.0.0.255 is the same as entering 192.168.1.1/24.				
any	Matches any source IP address.				

Mode Global Configuration

Usage Use this command when configuring a standard numbered access-list for filtering IP software packets. For backwards compatibility you can either create the access-list from within this command, or you can enter this command followed by only the standard access-list name. This moves you to the IPv4 Standard ACL Configuration mode for the selected standard numbered access-list, and from here you can configure the deny or permit filters for this selected standard numbered access-list.

See the table “[Access List Commands and Prompts](#)” in this chapter which shows the prompts at which ACL commands are entered.

Example To create ACL number 67 that will deny packets from subnet 172.16.10, use the commands:

```
awplus# configure terminal
awplus(config)# access-list 67 deny 172.16.10.0 0.0.0.255
```

Alternatively, to enter the IPv4 Standard ACL Configuration mode to create the ACL filter and deny packets from subnet 172.16.10.0 for the standard numbered access-list 67, use the commands:

```
awplus# configure terminal
awplus(config)# access-list 67
awplus(config-ip-std-acl)# deny 172.16.10.0 0.0.0.255
```

Related Commands [access-list standard \(named\) filter](#)
[show running-config](#)
[show ip access-list](#)

access-list standard (named) filter

This ACL filter adds a source IP address filter entry to a current named standard access-list. If the sequence number is specified, the new filter entry is inserted at the specified location. Otherwise, the new entry is added at the end of the access-list.

The **no** variant of this command removes a source IP address filter entry from the current named standard access-list. You can specify the source IP address filter entry for removal by entering either its sequence number (i.e. **no 10**), or by entering its source IP address filter profile without specifying its sequence number.

Note that the sequence number can be found by running the command, the [show access-list command on page 50.69](#).

Syntax [*<sequence-number>*] {deny|permit} {<source> [exact-match] | any}

no {deny|permit} {<source> [exact-match] | any}

no <sequence-number>

Parameter	Description				
<i><sequence-number></i>	<1-65535> The sequence number for the filter entry of the selected access control list.				
deny	Access-list rejects packets of the source filtering specified.				
permit	Access-list allows packets of the source filtering specified				
<i><source></i>	The source address of the packets. You can specify either a subnet or all sources. The following are the valid formats for specifying the source: <table border="1" data-bbox="790 1198 1428 1422"> <tbody> <tr> <td><i><ip-addr>/<prefix></i></td> <td>An IPv4 address, followed by a forward slash, then the prefix length. This matches any destination IP address within the specified subnet.</td> </tr> <tr> <td><i><ip-addr></i></td> <td>An IPv4 address in a.b.c.d format.</td> </tr> </tbody> </table>	<i><ip-addr>/<prefix></i>	An IPv4 address, followed by a forward slash, then the prefix length. This matches any destination IP address within the specified subnet.	<i><ip-addr></i>	An IPv4 address in a.b.c.d format.
<i><ip-addr>/<prefix></i>	An IPv4 address, followed by a forward slash, then the prefix length. This matches any destination IP address within the specified subnet.				
<i><ip-addr></i>	An IPv4 address in a.b.c.d format.				
exact-match	Specify an exact IP prefix to match on.				
any	Matches any source IP address.				

Mode IPv4 Standard ACL Configuration

Usage An ACL can be configured with multiple ACL filters using sequence numbers. If the sequence number is omitted, the next available multiple of 10 will be used as the sequence number for the new filter. A new ACL filter can be inserted into the middle of an existing list by specifying the appropriate sequence number

Note  The access control list being configured is selected by running the [access-list standard \(named\) command on page 50.57](#), with the required access control list number, or name, but with no further parameters selected.

Example Use the following commands to add a new filter entry to access-list `my-list` that will reject

IP address 10.1.1.1:

```
awplus# configure terminal
awplus(config)# access-list standard my-list
awplus(config-ip-std-acl)# deny 10.1.1.1/32
```

Example Use the following commands to insert a new filter entry into access-list `my-list` at sequence position number 15 that will accept IP network 10.1.2.0:

```
awplus# configure terminal
awplus(config)# access-list standard my-list
awplus(config-ip-std-acl)# 15 permit 10.1.2.0/24
```

Related Commands `access-list standard (named)`
`show running-config`
`show ip access-list`

access-list (standard numbered) filter

This ACL filter adds a source IP address filter entry to a current standard numbered access-list. If a sequence number is specified, the new filter entry is inserted at the specified location. Otherwise, the new filter entry is added at the end of the access-list.

The **no** variant of this command removes a source IP address filter entry from the current standard numbered access-list. You can specify the source IP address filter entry for removal by entering either its sequence number (i.e. **no 10**), or by entering its source IP address filter profile without specifying its sequence number.

Note that the sequence number can be found by running the command, the [show access-list command on page 50.69](#).

Syntax [*<sequence-number>*] {deny|permit} {<source>|host <host-address>|any}
 no {deny|permit} {<source>|host <host-address>|any}
 no <sequence-number>

Parameter	Description						
<i><sequence-number></i>	<1-65535> The sequence number for the filter entry of the selected access control list.						
deny	Access-list rejects packets of the type specified.						
permit	Access-list allows packets of the type specified						
<i><source></i>	The source address of the packets. You can specify either a subnet or all sources. The following are the valid formats for specifying the source: <table border="1" data-bbox="790 1198 1420 1444"> <tbody> <tr> <td><i><ip-addr></i></td> <td>Enter a reverse mask for the source address in dotted decimal format. For example, entering 192.168.1.1 0.0.0.255 is the same as entering 192.168.1.1/24.</td> </tr> <tr> <td><i><reverse-mask></i></td> <td></td> </tr> <tr> <td><i><ip-addr></i></td> <td>An IPv4 address in a.b.c.d format.</td> </tr> </tbody> </table>	<i><ip-addr></i>	Enter a reverse mask for the source address in dotted decimal format. For example, entering 192.168.1.1 0.0.0.255 is the same as entering 192.168.1.1/24.	<i><reverse-mask></i>		<i><ip-addr></i>	An IPv4 address in a.b.c.d format.
<i><ip-addr></i>	Enter a reverse mask for the source address in dotted decimal format. For example, entering 192.168.1.1 0.0.0.255 is the same as entering 192.168.1.1/24.						
<i><reverse-mask></i>							
<i><ip-addr></i>	An IPv4 address in a.b.c.d format.						
host	A single source host.						
<i><host-address></i>	Single source host address.						
any	Matches any source IP address.						

Mode IPv4 Standard ACL Configuration

Usage An ACL can be configured with multiple ACL filters using sequence numbers. If the sequence number is omitted, the next available multiple of 10 will be used as the sequence number for the new filter. A new ACL filter can be inserted into the middle of an existing list by specifying the appropriate sequence number

Note  The access control list being configured is selected by running the [access-list standard \(named\) command on page 50.57](#), with the required access control list number, or name, but with no further parameters selected.

Example To add a new entry accepting the IP network 10.1.1.0/24 at the sequence number 15 position, use the commands:

```
awplus# configure terminal
awplus(config)# access-list 99
awplus(config-ip-std-acl)# 15 permit 10.1.2.0 0.0.0.255
```

Related Commands [access-list \(standard numbered\)](#)
[show running-config](#)
[show ip access-list](#)

clear ip prefix-list

Use this command to reset the hit count to zero in the prefix-list entries.

Syntax `clear ip prefix-list [list-name] [ip-address/mask]`

Parameter	Description
<i>list-name</i>	The name of the prefix-list
<i>ip-address</i> / <i>mask</i>	The IP prefix and length

Mode Privileged Exec

Example To clear a prefix-list named List1:

```
awplus# clear ip prefix-list List1
```

ip prefix-list

Use this command to create an entry for a prefix list.

Use the **no** variant of this command to delete the prefix-list entry.

Syntax

```
ip prefix-list <list-name> seq <1-429496725>
    {deny|permit}
    {any|<ip-prefix>}
    [ge <0-32>] [le <0-32>]

no ip prefix-list <list-name> seq <1-429496725>

ip prefix-list <list-name> description <text>

no ip prefix-list <list-name> description <text>

ip prefix-list sequence-number

no ip prefix-list sequence-number
```

Parameter	Description
<list-name>	Specifies the name of a prefix list.
seq <1-429496725>	Sequence number of the prefix list entry.
deny	Specifies that the prefixes are excluded from the list.
permit	Specifies that the prefixes are included in the list.
<ip-prefix>	A.B.C.D/M specifies the IP address and length of the network mask.
any	Any prefix match. Same as 0.0.0.0 le 32 .
le <0-32>	Specifies the maximum prefix length to be matched.
ge <0-32>	Specifies the minimum prefix length to be matched.
description <text>	Text description of the prefix list.

Mode Global Configuration

Usage When the device processes a prefix list, it starts to match prefixes from the top of the prefix list, and stops whenever a match or deny occurs. To promote efficiency, use the **seq** parameter and place common matches or denials towards the top of the list. If you do not use the **seq** parameter, the sequence values are generated in the sequence of 5.

The parameters **ge** and **le** specify the range of the prefix lengths to be matched. When setting these parameters, set the **le** value to be less than 32, and the **ge** value to be less than the **le** value.

Example In the below sample configuration, the last `ip prefix-list` command in the below list matches all, and the first `ip prefix-list` command denies the IP network 76.2.2.0:

```
awplus(config)# router bgp 100
awplus(config-router)# network 172.1.1.0
awplus(config-router)# network 172.1.2.0
awplus(config-router)# neighbor 10.6.5.3 remote-as 300
awplus(config-router)# neighbor 10.6.5.3 prefix-list mylist out
awplus(config-router)# exit

awplus(config)# ip prefix-list mylist seq 5 deny
                        76.2.2.0/24

awplus(config)# ip prefix-list mylist seq 100 permit any
```

To deny the IP addresses between 10.0.0.0/14 (10.0.0.0 255.252.0.0) and 10.0.0.0/22 (10.0.0.0 255.255.252.0) within the 10.0.0.0/8 (10.0.0.0 255.0.0.0) addressing range, enter the following commands:

```
awplus# configure terminal
awplus(config)# ip prefix-list mylist seq 12345 deny 10.0.0.0/
                        8 le 22 ge 14
```

Related Commands [match ip address](#)
[neighbor prefix-list](#)
[match route-type](#)

maximum-access-list

Sets the maximum number of filters that can be added to any access-list. These are access-lists within the ranges <1-199>, <1300-1999> and <2000-2699> and named standard and extended access-lists.

Hardware access-lists are excluded from this command. These lists are those within the ranges <3000-3699> and <4000-4699>.

The **no** variant of this command removes the limit on the number of filters that can be added to a software access-list

Syntax `maximum-access-list <1-4294967294>`

`no maximum-access-list`

Parameter	Description
<1-4294967294>	Filter range.

Mode Global Configuration

Example To set the maximum number of software filters to 200:

```
awplus# configure terminal
awplus(config)# maximum-access-list 200
```

Related Commands [remote-command](#)

show access-group

Use this command to show the access-lists attached globally. If an access-list is specified, only that access-list will be displayed.

Syntax `show access-group [{<3000-3699>|<4000-4699>|<access-list-name>}]`

Parameter	Description
<code><3000-3699></code>	Optional. Specify a Hardware IP access-list.
<code><4000-4699></code>	Optional. Specify a Hardware MAC access-list.
<code><access-list-name></code>	Optional. Specify a Hardware IPv6 access-list name.

Mode Privileged Exec

Example To show all access-lists attached globally:

```
awplus# show access-group
```

Output Figure 50-1: Example output from the `show access-group` command

```
Global access control list
access-group 3000
access-group 4000
```

Related Commands [ip prefix-list](#)

show access-list

Use this command to display the specified access-list, or all access-lists if none have been specified. Note that only defined access-lists are displayed. An error message is displayed for an undefined access-list

Syntax `show access-list`
`[<1-99>|<100-199>|<1300-1999>|<3000-3699>|<4000-4499>|`
`<access-list-name>]`

Parameter	Description
<1-99>	IP standard access-list.
<100-199>	IP extended access-list.
<1300-1999>	IP standard access-list (standard - expanded range).
<2000-2699>	IP extended access-list (extended - expanded range).
<3000-3699>	Hardware IP access-list.
<4000-4499>	Hardware MAC access-list.
<access-list-name>	IP named access-list.

Mode Privileged Exec

Example To show all access-lists configured on the switch:

```
awplus# show access-list
```

```
Standard IP access list 1
  deny 172.16.2.0, wildcard bits 0.0.0.255
Standard IP access list 20
  deny 192.168.10.0, wildcard bits 0.0.0.255
  deny 192.168.12.0, wildcard bits 0.0.0.255
Hardware IP access list 3001
  permit ip 192.168.20.0 255.255.255.0 any
Hardware IP access list 3020
  permit tcp any 192.0.2.0/24
awplus#show access-list 20
```

Example To show the access-list with an ID of 20:

```
awplus# show access-list 20
```

```
Standard IP access-list 20
  deny 192.168.10.0, wildcard bits 0.0.0.255
  deny 192.168.12.0, wildcard bits 0.0.0.255
```

Note the below error message if you attempt to show an undefined access-list:

```
awplus# show access-list 2
```

```
% Can't find access-list 2
```

Related Commands [access-list \(standard numbered\)](#)
[access-list \(extended numbered\)](#)

show interface access-group

Use this command to display the access groups attached to a port. If an access group is specified, then the output only includes the ports that the specified access group is attached to. If no access group is specified then this command displays all access groups that are attached to the ports that are specified with *<port-list>*.

Note that **access group** is the term given for an access-list when it is applied to an interface.

Syntax `show interface <port-list> access-group
[<3000-3699> | <4000-4699> | <access-list-name>]`

Parameter	Description
<i><port-list></i>	Optional. Specify the ports to display information. A port-list can be either: <ul style="list-style-type: none"> ■ a switch port (e.g. port1.2.12) a static channel group (e.g., sa3) or a dynamic (LACP) channel group (e.g., po3) ■ a continuous range of ports separated by a hyphen, e.g., port1.0.1-1.0.24 or port1.1.1-port1.1.24 or po1-po4 ■ a comma-separated list of ports and port ranges, e.g. port1.0.1,port1.1.1-1.2.24. Do not mix switch ports, static channel groups, and LACP channel groups in the same list.
<code>access group</code>	Select the access group whose details you want to show.
<i><3000-3699></i>	Specifies the Hardware IP access-list.
<i><4000-4699></i>	Specifies the Hardware MAC access-list.
<i><access-list-name></i>	Specify the Hardware IPv6 access-list name.

Mode Exec and Privileged Exec

Example To show all access-lists attached to port1.0.1:

```
awplus# show interface port1.0.1 access-group
```

Output Figure 50-2: Example output from the **show interface access-group** command

```
Interface port1.0.1
  access-group 3000
  access-group 3002
  access-group 3001
```

Related Commands `access-group`

show ip access-list

Use this command to display IP access-lists.

Syntax `show ip access-list [<1-99>|<100-199>|<1300-1999>|<2000-2699>|<access-list-name>]`

Parameter	Description
<1-99>	IP standard access-list.
<100-199>	IP extended access-list.
<1300-1999>	IP standard access-list (expanded range).
<2000-2699>	IP extended access-list (expanded range).
<access-list-name>	IP named access-list.

Mode Privileged Exec

Usage This command only displays the IP access-lists; it does not display the **hardware** access-lists, i.e. those in the ranges: 3000 to 3699 and 4000 to 4699.

Example

```
awplus# show ip access-list
```

Output Figure 50-3: Example output from the **show ip access-list** command

```
Standard IP access-list 1
 permit 172.168.6.0, wildcard bits 0.0.0.255
 permit 192.168.6.0, wildcard bits 0.0.0.255
```

show ip prefix-list

Use this command to display the prefix-list entries. Note that this command is valid for RIP and BGP routing protocols only.

Syntax `show ip prefix-list [<name>|detail|summary]`

Parameter	Description
<name>	Name of a prefix list.
detail	Detail of the prefix list.
summary	Summary of prefix lists.

Mode Privileged Exec

Example

```
awplus# show ip prefix-list
awplus# show ip prefix-list 10.10.0.98/8
awplus# show ip prefix-list detail
```

Chapter 51: IPv6 Access Control List (ACL) Commands



Introduction.....	51.2
Access List Commands and Prompts.....	51.2
Command List.....	51.3
ipv6 access-list extended (named).....	51.3
ipv6 access-list extended IP protocol filter.....	51.7
ipv6 access-list extended TCP UDP filter.....	51.10
ipv6 access-list (named).....	51.12
ipv6 access-list named ICMP filter.....	51.13
ipv6 access-list named IPv6 protocol filter.....	51.16
ipv6 access-list named TCP UDP filter.....	51.20
ipv6 access-list standard (named).....	51.23
ipv6 access-list standard IPv6 filter.....	51.25
ipv6 traffic-filter.....	51.27
show ipv6 access-list.....	51.29

Introduction

This chapter provides an alphabetical reference for the Access Control List (ACL) commands.

To apply ACLs to an LACP channel group, apply it to all the individual switch ports in the channel group. To apply ACLs to a static channel group, apply it to the static channel group itself. For more information on link aggregation see, "[Static and Dynamic \(LACP\) Link Aggregation](#)" on page 14.16, Chapter 20, [Link Aggregation Configuration](#), and [Chapter 21, Link Aggregation Commands](#).

Access List Commands and Prompts

Many of the ACL commands operate from sub-modes that are specific to particular ACL types. The table "[Access List Commands and Prompts](#)" shows the CLI prompts at which ACL commands are entered.

Table 51-1: Access List Commands and Prompts

Command Name	Command Mode	Prompt
show ipv6 access-list	Privileged Exec	awplus#
ipv6 access-list (named)	Global Configuration	awplus(config)#
ipv6 access-list extended (named)	Global Configuration	awplus(config)#
ipv6 access-list standard (named)	Global Configuration	awplus(config)#
ipv6 traffic-filter	Interface Configuration	awplus(config-if)#
ipv6 access-list extended IP protocol filter	IPv6 Extended ACL Configuration	awplus(config-ipv6-ext-acl)#
ipv6 access-list extended TCP UDP filter	IPv6 Extended ACL Configuration	awplus(config-ipv6-ext-acl)#
ipv6 access-list named ICMP filter	IPv6 Hardware ACL Configuration	awplus(config-ipv6-hw-acl)#
ipv6 access-list named IPv6 protocol filter	IPv6 Hardware ACL Configuration	awplus(config-ipv6-hw-acl)#
ipv6 access-list named TCP UDP filter	IPv6 Hardware ACL Configuration	awplus(config-ipv6-hw-acl)#
ipv6 access-list standard IPv6 filter	IPv6 Standard ACL Configuration	awplus(config-ipv6-std-acl)#

Command List

ipv6 access-list extended (named)

Use this command when configuring an IPv6 extended access-list for filtering frames that permit or deny IP, ICMP, TCP, UDP packets or ICMP packets with a specific value based on the source or destination.

The **no** variant of this command removes a specified IPv6 extended access-list.

Syntax [any|icmp|ip]

```
ipv6 access-list extended <list-name>
  {deny|permit} {any|icmp|ip}
  {<ipv6-source-address/prefix-length>|any}
  {<ipv6-destination-address/prefix-length>|any}
  [<icmp-type <icmp-type>] [log]
```

```
no ipv6 access-list extended <list-name>
  {deny|permit} {any|icmp|ip}
  {<ipv6-source-address/prefix-length>|any}
  {<ipv6-destination-address/prefix-length>|any}
  [<icmp-type <icmp-type>] [log]
```

Syntax [tcp|udp]

```
ipv6 access-list extended <list-name>
  {deny|permit} {tcp|udp}
  {<ipv6-source-address/prefix-length>|any}
  {eq <sourceport>|lt <sourceport>|gt <sourceport>|ne <sourceport>}
  {<ipv6-destination-address/prefix-length>|any}
  {eq <destport>|lt <destport>|gt <destport>|ne <destport>}
  [log]
```

```
no ipv6 access-list extended <list-name> {deny|permit} {tcp|udp}
  {<ipv6-source-address/prefix-length>|any}
  {eq <sourceport>|lt <sourceport>|gt <sourceport>|ne <sourceport>}
  {<ipv6-destination-addr/prefix-length>|any}
  {eq <destport>|lt <destport>|gt <destport>|ne <destport>}
  [log]
```

Parameter	Description
<list-name>	A user-defined name for the IPv6 software extended access-list.
deny	The IPv6 software extended access-list rejects packets that match the type, source, and destination filtering specified with this command.
permit	The IPv6 software extended access-list permits packets that match the type, source, and destination filtering specified with this command.
any	For ICMP IP The IPv6 software extended access-list matches any type of packet.
ip	For ICMP IP The IPv6 software extended access-list matches only IP packets.

Parameter (cont.)	Description (cont.)
<code>icmp</code>	For ICMP/IP The IPv6 software extended access-list matches only ICMP packets.
<code>tcp</code>	For TCP/UDP The IPv6 software extended access-list matches only TCP packets.
<code>udp</code>	For TCP/UDP The IPv6 software extended access-list matches only UDP packets.
<code><ipv6-source-address/prefix-length></code>	Specifies a source address and prefix length. The IPv6 address prefix uses the format X:X::/prefix-length. The prefix-length is usually set between 0 and 64, or has the value 128.
<code><ipv6-destination-address/prefix-length></code>	Specifies a destination address and prefix length. The IPv6 address uses the format X:X::X/X/Prefix-Length. The prefix-length is usually set between 0 and 64, or has the value 128.
<code>any</code>	Matches any IPv6 address.
<code><sourceport></code>	For TCP/UDP The source port number, specified as an integer between 0 and 65535.
<code><destport></code>	For TCP/UDP The destination port number, specified as an integer between 0 and 65535.
<code>icmp-type</code>	For ICMP/IP Matches only a specified type of ICMP messages. This is valid only when the filtering is set to match ICMP packets.
<code>eq</code>	For TCP/UDP Matches port numbers equal to the port number specified immediately after this parameter.
<code>lt</code>	For TCP/UDP Matches port numbers less than the port number specified immediately after this parameter.
<code>gt</code>	For TCP/UDP Matches port numbers greater than the port number specified immediately after this parameter.
<code>ne</code>	For TCP/UDP Matches port numbers not equal to the port number specified immediately after this parameter.

Parameter (cont.)	Description (cont.)
<i><icmp-type></i>	For ICMP IP The ICMP type, as defined in RFC792 and RFC950. Specify one of the following integers to create a filter for the ICMP message type:
	0 Echo replies.
	3 Destination unreachable messages.
	4 Source quench messages.
	5 Redirect (change route) messages.
	8 Echo requests.
	11 Time exceeded messages.
	12 Parameter problem messages.
	13 Timestamp requests.
	14 Timestamp replies.
	15 Information requests.
	16 Information replies.
	17 Address mask requests.
	18 Address mask replies.
log	Logs the results.

Mode Global Configuration and IPv6 Extended ACL Configuration

Usage Use IPv6 extended access-lists to control the transmission of IPv6 packets on an interface, and restrict the content of routing updates. The switch stops checking the IPv6 extended access-list when a match is encountered.

For backwards compatibility you can either create IPv6 extended access-lists from within this command, or you can enter `ipv6 access-list extended` followed by only the IPv6 extended access-list name. This latter (and preferred) method moves you to the `(config-ipv6-ext-acl)` prompt for the selected IPv6 extended access-list number, and from here you can configure the filters for this selected access-list.

Example To add a new filter to the access-list named `my-list` that will reject incoming ICMP packets from `2001:0db8::0/64` to `2001:0db8::f/64`, use the commands:

```
awplus# configure terminal
awplus(config)# ipv6 access-list extended my list
awplus(config-ipv6-ext-acl)# icmp 2001:0db8::0/64 2001:0db8::f/64
```

Example To insert a new filter at sequence number 5 of the access-list named `my-list` that will accept ICMP type 8 packets from the `2001:0db8::0/64` network to the `2001:0db8::f/64` network, use the commands:

```
awplus# configure terminal
awplus(config)# ipv6 access-list extended my list
awplus(config-ipv6-ext-acl)# 5 icmp 2001:0db8::0/64
2001:0db8::f/64
```

Example To create the access-list named `TK` to deny TCP protocols, use the commands:

```
awplus# configure terminal
awplus(config)# ipv6 access-list extended TK deny tcp any eq
14 any lt 12 log
```

Related Commands [ipv6 access-list extended IP protocol filter](#)
[ipv6 access-list extended TCP UDP filter](#)
[show running-config](#)
[show ipv6 access-list](#)

ipv6 access-list extended IP protocol filter

Use this ACL filter to add a filter entry for an IPv6 source and destination address and prefix, with or without an IP protocol specified, to the current extended IPv6 access-list. If a sequence is specified, the new entry is inserted at the specified location. Otherwise, the new entry is added at the end of the access-list.

The **no** variant of this command removes a filter entry for an IPv6 source and destination address and prefix, with or without an IP protocol filter entry, from the current extended IPv6 access-list. You can specify the ACL filter entry by entering either its sequence number, or its filter entry profile.

Syntax
[ip|proto] [*<sequence-number>*]
 {deny|permit} {ip|any|proto *<ip-protocol>*}
 {*<ipv6-source-address/prefix>*|any}
 {*<ipv6-destination-address/prefix>*|any} [log]

no {deny|permit} {ip|any|proto *<ip-protocol>*}
 {*<ipv6-source-address/prefix>*|any}
 {*<ipv6-destination-address/prefix>*|any} [log]

no [*<sequence-number>*]

Parameter	Description
<i><sequence-number></i>	<i><1-65535></i> The sequence number for the filter entry of the selected access control list.
deny	Specifies the packets to reject.
permit	Specifies the packets to accept.
ip	IP packet.
any	Any packet.
proto <i><ip-protocol></i>	The IP Protocol type specified by its protocol number <i><1-255></i> .
<i><ip-protocol></i>	The IP protocol number, as defined by IANA (Internet Assigned Numbers Authority www.iana.org ref: http://www.iana.org/assignments/protocol-numbers)
	Protocol Number
	1
	2
	3
	4
	5
	6
	8
	9
	11
	17

Parameter (cont.)	Description (cont.)
<i><ip-protocol></i>	20
(cont.)	27
	28
	29
	30
	33
	48
	50
	51
	54
	58
	59
	60
	88
	89
	97
	98
	108
	112
	134
	135
	136
	137
	138
	139–252
	253
	254
	255
<i><ipv6-source-address/prefix></i>	IPv6 source address, or local address. The IPv6 address uses the format X::X:X/Prefix-Length. The prefix-length is usually set between 0 and 64, or has the value 128.
any	Any source address or local address.
<i><ipv6-destination-address/prefix></i>	IPv6 destination address, or local address. The IPv6 address uses the format X::X:X/Prefix-Length. The prefix-length is usually set between 0 and 64, or has the value 128.

Parameter (cont.)	Description (cont.)
any	Any destination address or remote address.
log	Log the results.

Mode IPv6 Extended ACL Configuration

Usage The filter entry will match on any IP protocol type packet that has the specified source and destination IPv6 addresses and the specified IP protocol type. The parameter `any` may be specified if an address does not matter.

Example To add a new ACL filter entry to the extended IPv6 access-list named `my-list` with sequence number 5 rejecting the IPv6 packet from `2001:db8:1:1` to `2001:db8:f:1`, use the commands:

```
awplus# configure terminal
awplus(config)# ipv6 access-list extended my-list
awplus(config-ipv6-ext-acl)# 5 deny ip 2001:db8:1::1/128
2001:db8:f::1/128
```

To remove the ACL filter entry to the extended IPv6 access-list named `my-list` with sequence number 5, use the commands:

```
awplus# configure terminal
awplus(config)# ipv6 access-list extended my-list
awplus(config-ipv6-ext-acl)# no 5
```

Related Commands [ipv6 access-list extended \(named\)](#)
[show running-config](#)
[show ipv6 access-list](#)

ipv6 access-list extended TCP UDP filter

Use this ACL filter to add a filter entry for an IPv6 source and destination address and prefix, with a TCP (Transmission Control Protocol) or UDP (User Datagram Protocol) source and destination port specified, to the current extended IPv6 access-list. If a sequence number is specified, the new entry is inserted at the specified location. Otherwise, the new entry is added at the end of the access-list.

The **no** variant of this command removes a filter entry for an IPv6 source and destination address and prefix, with a TCP or UDP source and destination port specified, from the current extended IPv6 access-list. You can specify the filter entry for removal by entering either its sequence number, or its filter entry profile.

Syntax
[tcp|udp]

```
[<sequence-number>] {deny|permit} {tcp|udp}
  {<ipv6-source-address/prefix>|any}
  {eq <sourceport>|lt <sourceport>|gt <sourceport>|ne <sourceport>}
  {<IPv6-destination-address/prefix>|any}
  {eq <destport>|lt <destport>|gt <destport>|ne <destport>} [log]

no {deny|permit} {tcp|udp}
  {<ipv6-source-address/prefix>|any}
  {eq <sourceport>|lt <sourceport>|gt <sourceport>|ne <sourceport>}}
  {<IPv6-destination-address/prefix>|any}
  {eq <destport>|lt <destport>|gt <destport>|ne <destport>} [log]

no <sequence-number>
```

Parameter	Description
<i><sequence-number></i>	<1-65535> The sequence number for the filter entry of the selected access control list.
deny	Specifies the packets to reject.
permit	Specifies the packets to accept.
tcp	TCP packet.
udp	UDP packet.
<i><ipv6-source-address/prefix></i>	IPv6 source address, or local address. The IPv6 address uses the format X:X::X:X/Prefix-Length. The prefix-length is usually set between 0 and 64, or has the value 128.
any	Any source address or local address.
eq	Equal to.
lt	Less than.
gt	Greater than.
ne	Not equal to.
<i><sourceport></i>	The source port number, specified as an integer between 0 and 65535.

Parameter (cont.)	Description (cont.)
<code><ipv6-destination-address/prefix></code>	IPv6 destination address, or local address. The IPv6 address uses the format X:X::X:X/Prefix-Length. The prefix-length is usually set between 0 and 64, or has the value 128.
<code><destport></code>	The destination port number, specified as an integer between 0 and 65535.
<code>log</code>	Log the results.

Mode IPv6 Extended ACL Configuration

Usage The filter entry will match on any packet that has the specified source and destination IPv6 addresses and the specified TCP or UDP source and destination port. The parameter `any` may be specified if an address does not matter.

Example To add a new filter entry with sequence number 5 to the access-list named `my-list` to reject TCP packets from `2001:0db8::0/64` port 10 to `2001:0db8::f/64` port 20, use the following commands:

```
awplus# configure terminal
awplus(config)# ipv6 access-list extended my-list
awplus(config-ipv6-ext-acl)# 5 deny tcp 2001:0db8::0/64 eq 10
2001:0db8::f/64 eq 20
```

To add a new filter entry with sequence number 5 to the extended IPv6 access-list named `my-list` to reject UDP packets from `3ffe::1` port 10 to `5ffe::1` port 20, use the following commands:

```
awplus# configure terminal
awplus(config)# ipv6 access-list extended my-list
awplus(config-ipv6-ext-acl)# 5 deny udp 2001:0db8::0/64 eq 10
2001:0db8::f/64 eq 20
```

To remove the filter entry with sequence number 5 to the extended IPv6 access-list named `my-list`, use the commands:

```
awplus# configure terminal
awplus(config)# ipv6 access-list extended my-list
awplus(config-ipv6-ext-acl)# no 5
```

Related Commands `ipv6 access-list extended (named)`
`show running-config`
`show ipv6 access-list`

ipv6 access-list (named)

Use this command to either create a new IPv6 hardware access-list, or to select an existing IPv6 hardware access-list in order to apply a filter entry to it.

Use the **no** variant of this command to delete an existing IPv6 hardware access-list.

Note Before you can delete an access-list, you must first remove it from any interface it is assigned to.



Syntax `ipv6 access-list <ipv6-access-list-name>`
`no ipv6 access-list <ipv6-access-list-name>`

Parameter	Description
<code><ipv6-access-list-name></code>	Specify an IPv6 access-list name.

Mode Global Configuration and IPv6 Hardware ACL Configuration

Usage Use IPv6 hardware named access-lists to control the transmission of IPv6 packets on an interface, and restrict the content of routing updates. The switch stops checking the IPv6 hardware named access-list when a match is encountered.

For backwards compatibility you can either create IPv6 hardware named access-lists from within this command, or you can enter `ipv6 access-list` followed by only the IPv6 hardware named access-list name. This latter (and preferred) method moves you to the `(config-ipv6-hw-acl)` prompt for the selected IPv6 hardware named access-list number, and from here you can configure the filters for this selected IPv6 hardware named access-list.

Examples To create an IPv6 access-list named `my-ipv6-acl`, use the commands:

```
awplus# configure terminal
awplus(config)# ipv6 access-list my-ipv6-acl
awplus(config-ipv6-hw-acl)#
```

To delete the IPv6 access-list named `my-ipv6-acl`, use the commands:

```
awplus# configure terminal
awplus(config)# no ipv6 access-list my-ipv6-acl
```

Validation Commands `show ipv6 access-list`

Related Commands `ipv6 traffic-filter`
`ipv6 traffic-filter`
`show ipv6 access-list`
`ipv6 access-list named ICMP filter`
`ipv6 access-list named TCP UDP filter`

ipv6 access-list named ICMP filter

Use this ACL filter to add a filter entry for an IPv6 source and destination address and prefix, with ICMP (Internet Control Message Protocol) packets, to the current named IPv6 access-list. If a sequence number is specified, the new entry is inserted at the specified location. Otherwise, the new entry is added at the end of the access-list.

As an optional parameter **vlan** can be matched for tagged (802.1q) packet.

The **no** variant of this command removes a filter entry for an IPv6 source and destination address and prefix, with ICMP (Internet Control Message Protocol) packets, from the current named IPv6 access-list. You can specify the filter entry for removal by entering either its sequence number, or its filter entry profile.

Syntax [ip|icmp]

```
[<sequence-number>
 {deny|permit|send-to-cpu|copy-to-cpu|copy-to-mirror}
 {ipv6|icmp}
 [<ipv6-source-address/prefix-length>|
 <ipv6-source-address> <ipv6-source-wildcard>|
 host <ipv6-source-host>|any}
 [<ipv6-destination-address/prefix-length>|
 <ipv6-destination-addr> <ipv6-destination-wildcard>|
 host <ipv6-destination-host-address>|any} [<icmp-type>]
 [vlan <1-4094>]
```

```
no [<sequence-number>]
 {deny|permit|send-to-cpu|copy-to-cpu|copy-to-mirror}
 {ip|icmp}
 [<ipv6-source-address/prefix-length>|
 <ipv6-source-address> <ipv6-source-wildcard>|
 host <ipv6-source-host>|any}
 [<ipv6-destination-address/prefix-length>|
 <ipv6-destination-address> <ipv6-destination-wildcard>|
 host <ipv6-destination-host-address>|any} [<icmp-type>]
 [vlan <1-4094>]
```

```
no [<sequence-number>]
```

Parameter	Description
<sequence-number>	<1-65535> The sequence number for the filter entry of the selected access control list.
deny	Specifies the packets to reject
permit	Specifies the packets to permit
send-to-cpu	Specifies the packets to send to the CPU
copy-to-cpu	Specifies the packets to copy to the CPU
copy-to-mirror	Specifies the packets to copy to the mirror port
ipv6	IPv6 packet, defined by the following parameters.
icmp	ICMP packet, defined by the following parameters.
<ipv6-source-address/ prefix-length>	Specifies a source address and prefix length. The IPv6 address prefix uses the format X:X::/prefix-length. The prefix-length is usually set between 0 and 64, or has the value 128.

Parameter (cont.)	Description (cont.)
<i><ipv6-source-address></i>	Specifies the IPv6 source address. The IPv6 address uses the format X:X::X:X.
<i><ipv6-source-wildcard></i>	Specifies source wildcard bits in IPv6 format X:X::X:X. Note that binary 1 represents a don't care condition, and binary 0 represents a match.
host <i><ipv6-source-host></i>	Specifies a single source host address. The IPv6 address uses the format X:X::X:X.
any	Specifies any Source host
<i><ipv6-destination-address/prefix-length></i>	Specifies a destination address and prefix length. The IPv6 address uses the format X:X::X:X/Prefix-Length. The prefix-length is usually set between 0 and 64, or has the value 128.
<i><ipv6-destination-address></i>	Specifies a destination address. The IPv6 address uses the format X:X::X:X.
<i><ipv6-destination-wildcard></i>	Specify destination Wildcard bits in IPv6 format X:X::X:X.
host <i><ipv6-destination-host-address></i>	Specify a single destination host address. The IPv6 address uses the format X:X::X:X.
any	Specifies any destination host.
<i><icmp-type></i>	Optional. Specify to filter by ICMP message type number. Valid values are from 0 to 255.
vlan	This parameter can be used in either single or double-tagged VLAN networks. It is the conventional VLAN tag (VID). In a double-tagged network it is sometimes referred to as the STAG.
<i><1-4094></i>	The VLAN VID.

Mode IPv6 Hardware ACL Configuration

Examples To specify a hardware IPv6 access-list named `my-ac11` and add an ACL filter entry that blocks all ICMP6 echo requests, enter the commands:

```
awplus# configure terminal
awplus(config)# ipv6 access-list my-ac11
awplus(config-ipv6-hw-acl)# deny icmp any any icmp-type 128
```

To specify a hardware IPv6 access-list named `my-ac12` and add an ACL filter entry that blocks all ICMP6 echo requests on the default VLAN (`vlan1`), enter the following commands:

```
awplus# configure terminal
awplus(config)# ipv6 access-list my-ac12
awplus(config-ipv6-hw-acl)# deny icmp any any icmp-type 128
                             vlan 1
```

To remove an ACL filter entry that blocks all ICMP6 echo requests from the hardware IPv6 access-list named `my-ac11`, enter the following commands:

```
awplus# configure terminal
awplus(config)# ipv6 access-list my-ac11
awplus(config-ipv6-hw-acl)# no deny icmp any any icmp-type 128
```

**Validation
Commands** `show ipv6 access-list`

Related Commands `ipv6 access-list (named)`
`ipv6 traffic-filter`
`ipv6 access-list named TCP UDP filter`
`show ipv6 access-list`

ipv6 access-list named IPv6 protocol filter

Use this ACL filter to add a filter entry for an IPv6 source and destination address and prefix, with an IP protocol type specified, to the current named IPv6 access-list. If a sequence number is specified, the new entry is inserted at the specified location. Otherwise, the new entry is added at the end of the access-list.

The **no** variant of this command removes a filter entry for an IPv6 source and destination address and prefix, with an IP protocol type specified, from the current named IPv6 access-list. You can specify the filter entry for removal by entering either its sequence number, or its filter entry profile.

Syntax

```
[<sequence-number>
 {deny|permit|send-to-cpu|copy-to-cpu|copy-to-mirror}
 {ipv6|proto <ip-protocol>}
 {<ipv6-source-prefix/prefix-length>|<ipv6-source-address>
 <ipv6-source-wildcard>|host <ipv6-source-host>|any}
 {<ipv6-destination-prefix/prefix-length>|
 <ipv6-destination-address> <ipv6-destination-wildcard>|
 host <ipv6-destination-host>|any}

[<sequence-number>]
 no {deny|permit|send-to-cpu|copy-to-cpu|copy-to-mirror}
 {ipv6|proto <ip-protocol>}
 {<ipv6-source-prefix/prefix-length>|<ipv6-source-address>
 <ipv6-source-wildcard>|host <ipv6-source-host>|any}
 {<ipv6-destination-prefix/prefix-length>|
 <ipv6-destination-address> <ipv6-destination-wildcard>|
 host <ipv6-destination-host>|any}

no [<sequence-number>]
```

Parameter	Description
<sequence-number>	<1-65535> The sequence number for the filter entry of the selected access control list.
deny	Specifies packets to reject
permit	Specifies packets to permit
send-to-cpu	Specifies packets to send to the CPU
copy-to-cpu	Specifies packets to copy to the CPU
copy-to-mirror	Specifies packets to copy to the mirror port
ipv6	Specifies IPv6 packet
proto <ip-protocol>	Specify IP protocol number <1-255>

Parameter (cont.)	Description (cont.)
<i><ip-protocol></i>	The IP protocol number, as defined by IANA (Internet Assigned Numbers Authority www.iana.org ref: http://www.iana.org/assignments/protocol-numbers)
	Protocol Number
	1
	2
	3
	4
	5
	6
	8
	9
	11
	17
	20
	27
	28
	29
	30
	33
	48
	50
	51
	54
	58
	59
	60
	88
	89

Parameter (cont.)	Description (cont.)
<i><ip-protocol></i> (cont.)	Protocol Number
	97
	98
	108
	112
	134
	135
	136
	137
	138
	139–252
	253
	254
	255
<i><ipv6-source-prefix/ prefix-length></i>	Specify source address and mask. The IPv6 address uses the format X:X::X:/Prefix-Length. The prefix-length is usually set between 0 and 64, or has the value 128.
<i><ipv6-source-address></i>	Specifies the source address. The IPv6 address uses the format X:X::X:X.
<i><ipv6-source-wildcard></i>	Specifies the source wildcard bits, in IPv6 format X:X::X.X.
host <i><ipv6-source-host></i>	Specifies a single source host. The IPv6 address uses the format X:X::X:X.
any	Specifies any source host. An abbreviation for the IPv6 prefix <i>::/0</i>
<i><ipv6-dest-prefix/prefix- length></i>	Specifies a destination address and mask. The IPv6 address prefix uses the format X:X::/prefix-length. The prefix-length is usually set between 0 and 64, or has the value 128.
<i><ipv6-destination- address></i>	Specify destination address. The IPv6 address uses the format X:X::X:X.
<i><ipv6-destination- wildcard></i>	Specify destination wildcard bits in IPv6 format X:X::X.X
host <i><ipv6-destination- host></i>	Specify a single destination host address. The IPv6 address uses the format X:X::X:X.
any	Specifies any destination host. An abbreviation for the IPv6 prefix <i>::/0</i>

Parameter (cont.)	Description (cont.)
vlan	This parameter can be used in either single or double-tagged VLAN networks. It is the conventional VLAN tag (VID). In a double-tagged network it is sometimes referred to as the STAG.
<1-4094>	The VLAN VID.

Mode IPv6 Hardware ACL Configuration

Usage This command adds a hardware classification filter (for use with features such as QoS), to a current standard IPv6 access-list. The filter will match on any IP protocol type packet that has the specified source and destination IPv6 addresses and the specified IP protocol type. The parameter *any* may be specified if an address does not matter,

Examples To add an ACL filter entry to block IP traffic from network 2001:0db8::0/64 to the hardware IPv6 access-list named `my-acl`, use the commands:

```
awplus# configure terminal
awplus(config)# ipv6 access-list my-acl
awplus(config-ipv6-hw-acl)# deny ipv6 2001:0db8::0/64
```

To remove an ACL filter entry that blocks all IPv6 traffic from network 2001:0db8::0/64 from the hardware IPv6 access-list named `my-acl`, use the commands:

```
awplus# configure terminal
awplus(config)# ipv6 access-list my-acl
awplus(config-ipv6-hw-acl)# no deny ipv6 2001:0db8::0/64
```

**Validation
Commands** show ipv6 access-list

Related Commands ipv6 access-list (named)
ipv6 traffic-filter
ipv6 access-list named ICMP filter
ipv6 access-list named TCP UDP filter
show ipv6 access-list

ipv6 access-list named TCP UDP filter

Use this ACL filter to add a filter entry for an IPv6 source and destination address and prefix, with TCP (Transmission Control Protocol) or UDP (User Datagram Protocol) source and destination ports specified, to the current named IPv6 access-list. If a sequence number is specified, the new entry is inserted at the specified location. Otherwise, the new entry is added at the end of the access-list.

The **no** variant of this command removes a filter entry for an IPv6 source and destination address and prefix, with TCP or UDP source and destination ports specified, from the current named IPv6 access-list. You can specify the filter entry for removal by entering either its sequence number, or its filter entry profile.

Syntax

```
[<sequence-number>]
  {deny|permit|send-to-cpu|copy-to-cpu|copy-to-mirror} {tcp|udp}
  {<ipv6-source-prefix/prefix-length>|
  <ipv6-source-address> <ipv6-source-wildcard>|
  host <ipv6-source-host>|any}
  {eq <sourceport>|lt <sourceport>|gt <sourceport>|ne <sourceport>}|
  [range <start-range> <end-range>]
  {<ipv6-destination-prefix/prefix-length>|
  <ipv6-destination-address> <ipv6-destination-wildcard>|
  host <ipv6-destination-host>|any}
  {[eq <destport>|lt <destport>|gt <destport>|ne <destport>}
  [range <start-range> <end-range>]

no {deny|permit|send-to-cpu|copy-to-cpu|copy-to-mirror} {tcp|udp}
  {<ipv6-source-prefix/prefix-length>|
  <ipv6-source-address> <ipv6-source-wildcard>|
  host <ipv6-source-host>|any}
  {eq <sourceport>|lt <sourceport>|gt <sourceport>|ne <sourceport>}|
  [range <start-range> <end-range>]
  {<ipv6-destination-prefix/prefix-length>|
  <ipv6-destination-address> <ipv6-destination-wildcard>
  |host <ipv6-destination-host>|any}
  {eq <destport>|lt <destport>|gt <destport>|ne <destport>}|
  [range <start-range> <end-range>]

no <sequence-number>
```

Parameter	Description
<sequence-number>	<1-65535> The sequence number for the filter entry of the selected access control list.
deny	Specify packets to reject.
permit	Specifies the packets to permit.
send-to-cpu	Specifies the packets to send to the CPU.
copy-to-cpu	Specifies the packets to copy to the CPU.
copy-to-mirror	Specifies the packets to copy to the mirror port.
tcp	Specifies a TCP packet.
udp	Specifies a UDP packet.

Parameter (cont.)	Description (cont.)
<i><ipv6-source-prefix/ prefix-length></i>	Specifies the source address with mask. The IPv6 address prefix uses the format X:X::/prefix-length. The prefix-length is usually set between 0 and 64, or has the value 128.
<i><ipv6-source-address></i>	Specifies the source address. The IPv6 address uses the format X:X::X:X.
<i><ipv6-source-wildcard></i>	Specifies the Source Wildcard bits in IPv6 format X:X::X:X.
host <i><ipv6-source-host></i>	Specifies the a single source host. The IPv6 address uses the format X:X::X:X.
any	Specifies any Source host. An abbreviation for the IPv6 prefix <i>::/0</i> .
eq	Equal to.
lt	Less than.
gt	Greater than.
ne	Not equal to.
<i><sourceport></i>	The source port number, specified as an integer between 0 and 65535.
<i><destport></i>	The destination port number, specified as an integer between 0 and 65535.
range	Range of port numbers. Match only packets within range.
<i><start-range></i>	The port number at the start of the range <i><0-65535></i> .
<i><end-range></i>	The port number at the end of the range <i><0-65535></i> .
<i><ipv6-dest-prefix/ prefix-length></i>	Specify destination address with mask. The IPv6 address prefix uses the format X:X::/prefix-length. The prefix-length is usually set between 0 and 64, or has the value 128.
<i><ipv6-destination- address></i>	Specify destination address. The IPv6 address uses the format X:X::X:X.
<i><ipv6-destination- wildcard></i>	Specify destination wildcard bits in IPv6 format X:X::X:X.
host <i><ipv6-destination-host></i>	Specify a single destination host address. The IPv6 address uses the format X:X::X:X.
any	Specifies any destination host. An abbreviation for the IPv6 prefix <i>::/0</i> .

Parameter (cont.)	Description (cont.)
vlan	This parameter can be used in either single or double-tagged VLAN networks. It is the conventional VLAN tag (VID). In a double-tagged network it is sometimes referred to as the STAG.
<1-4094>	The VLAN VID.

Mode IPv6 Hardware ACL Configuration

Usage The filter entry will match on any TCP or UDP packet that has the specified source and destination IPv6 addresses and TCP or UDP type. The parameter `any` may be specified if an address does not matter.

Example To add an ACL filter entry that blocks all SSH traffic from network `2001:0db8::0/64` to the hardware IPv6 access-list named `my-acl`, use the commands:

```
awplus# configure terminal
awplus(config)# ipv6 access-list my-acl
awplus(config-ipv6-hw-acl)# deny tcp 2001:0db8::0/64 any eq 22
```

To add an ACL filter entry that blocks all SSH traffic from network `2001:0db8::0/64` on the default VLAN (`vlan1`) to the hardware IPv6 access-list named `my-acl`, use the commands:

```
awplus# configure terminal
awplus(config)# ipv6 access-list my-acl
awplus(config-ipv6-hw-acl)# deny tcp 2001:0db8::0/64 any eq 22
vlan 1
```

To remove an ACL filter entry that blocks all SSH traffic from network `2001:0db8::0/64` from the hardware IPv6 access-list named `my-acl`, use the commands:

```
awplus# configure terminal
awplus(config)# ipv6 access-list my-acl
awplus(config-ipv6-hw-acl)# no deny tcp 2001:0db8::0/64 any eq 22
```

Validation Commands `show ipv6 access-list`

Related Commands `ipv6 access-list (named)`
`ipv6 traffic-filter`
`ipv6 traffic-filter`
`ipv6 access-list named ICMP filter`
`show ipv6 access-list`

ipv6 access-list standard (named)

This command configures an IPv6 standard access-list for filtering frames that permit or deny IPv6 packets from a specific source IPv6 address.

The **no** variant of this command removes a specified IPv6 standard access-list.

Syntax

```

ipv6 access-list standard <ipv6-acl-list-name>
  [{deny|permit}
  <ipv6-source-address/prefix-length> | any}
  [exact-match]]

no ipv6 access-list standard <ipv6-acl-list-name>
  [{deny|permit}
  <ipv6-source-address/prefix-length> | any}
  [exact-match]]
  
```

Parameter	Description
<ipv6-acl-list-name>	A user-defined name for the IPv6 software standard access-list.
deny	The IPv6 software standard access-list rejects packets that match the type, source, and destination filtering specified with this command.
permit	The IPv6 software standard access-list permits packets that match the type, source, and destination filtering specified with this command.
<ipv6-source-address/prefix-length>	Specifies a source address and prefix length. The IPv6 address prefix uses the format X:X::/prefix-length. The prefix-length is usually set between 0 and 64, or has the value 128.
any	Matches any source IPv6 address.
exact-match	Exact match of the prefixes.

Mode Global Configuration and IPv6 Standard ACL Configuration

Usage Use IPv6 standard access-lists to control the transmission of IPv6 packets on an interface, and restrict the content of routing updates. The switch stops checking the IPv6 standard access-list when a match is encountered.

For backwards compatibility you can either create IPv6 standard access-lists from within this command, or you can enter `ipv6 access-list standard` followed by only the IPv6 standard access-list name. This latter (and preferred) method moves you to the `(config-ipv6-std-acl)` prompt for the selected IPv6 standard access-list number, and from here you can configure the filters for this selected IPv6 standard access-list.

Example To enter the IPv6 Standard ACL Configuration mode for the access-list named `my-list`, use the commands:

```
awplus# configure terminal
awplus(config)# ipv6 access-list standard my-list
awplus(config-ipv6-std-acl)#
```

Related Commands `ipv6 access-list standard IPv6 filter`
`show running-config`
`show ipv6 access-list`

ipv6 access-list standard IPv6 filter

Use this ACL filter to add a filter entry for an IPv6 source address and prefix length to the current standard IPv6 access-list. If a sequence number is specified, the new entry is inserted at the specified location. Otherwise, the new entry is added at the end of the access-list.

The **no** variant of this command removes a filter entry for an IPv6 source address and prefix from the current standard IPv6 access-list. You can specify the filter entry for removal by entering either its sequence number, or its filter entry profile.

Syntax [**icmp**]

```
[<sequence-number>] {deny|permit}
    {<IPv6-source-address/prefix-length>|any}

no {deny|permit}
    {<IPv6-source-address/prefix-length>|any}

no <sequence-number>
```

Parameter	Description
<sequence-number>	<1-65535> The sequence number for the filter entry of the selected access control list.
deny	Specifies the packets to reject.
permit	Specifies the packets to accept.
<IPv6-source-address/prefix-length>	IPv6 source address and prefix-length in the form X:X::X:X/P.
any	Any IPv6 source host address.

Mode IPv6 Standard ACL Configuration

Usage The filter entry will match on any IPv6 packet that has the specified IPv6 source address and prefix length. The parameter **any** may be specified if an address does not matter.

Example To add an ACL filter entry with sequence number 5 that will deny any IPv6 packets to the standard IPv6 access-list named **my-list**, enter the commands:

```
awplus# configure terminal
awplus(config)# ipv6 access-list standard my-list
awplus(config-ipv6-std-acl)# 5 deny any
```

To remove the ACL filter entry that will deny any IPv6 packets from the standard IPv6 access-list named **my-list**, enter the commands:

```
awplus# configure terminal
awplus(config)# ipv6 access-list standard my-list
awplus(config-ipv6-std-acl)# no deny any
```

Alternately, to remove the ACL filter entry with sequence number 5 to the standard IPv6 access-list named `my-list`, enter the commands:

```
awplus# configure terminal
awplus(config)# ipv6 access-list standard my-list
awplus(config-ipv6-std-acl)# no 5
```

Related Commands [ipv6 access-list standard \(named\)](#)
[show running-config](#)
[show ipv6 access-list](#)

ipv6 traffic-filter

This command adds an IPv6 hardware-based access-list to an interface. The number of access-lists that can be added is determined by the amount of available space in the hardware-based packet classification tables. You can apply an IPv6 hardware access-list to all ports or selected ports.

Use the **no** variant of this command to remove an IPv6 hardware-based access-list from an interface. You can remove an IPv6 hardware access-list from all ports or selected ports as required.

Syntax `ipv6 traffic-filter <ipv6-access-list-name>`
`no ipv6 traffic-filter <ipv6-access-list-name>`

Parameter	Description
<code><ipv6-access-list-name></code>	Hardware IPv6 access-list name.

Usage This command adds an IPv6 hardware-based access-list to an interface. The number of access-lists that can be added is determined by the amount of available space in the hardware-based packet classification tables.

To apply the access-list to all ports on the switch, execute the command in the Global Configuration mode. To apply the access-list to a layer two interface or layer two interface range, apply the command in the Interface Configuration mode. See the examples for each mode below.

Mode Interface Configuration (to apply an IPv6 hardware ACL to a specific switch port) and Global Configuration (to apply an IPv6 hardware ACL to all of the switch ports)

Examples To add access-list `ac11` as a traffic-filter to all ports on the switch, enter the commands:

```
awplus# configure terminal
awplus(config)# ipv6 traffic-filter ac11
```

To add access-list `ac11` as a traffic-filter to interface `port1.0.1`, enter the commands:

```
awplus# configure terminal
awplus(config)# interface port1.0.1
awplus(config-if)# ipv6 traffic-filter ac11
```

To remove access-list `ac11` as a traffic-filter from all ports on the switch, enter the commands:

```
awplus# configure terminal
awplus(config)# no ipv6 traffic-filter ac11
```

To remove access-list `ac11` as a traffic-filter from interface `port1.0.1`, enter the commands:

```
awplus# configure terminal
awplus(config)# interface port1.0.1
awplus(config-if)# no ipv6 traffic-filter ac11
```

Related Commands

- `ipv6 access-list (named)`
- `ipv6 traffic-filter`
- `ipv6 access-list named ICMP filter`
- `ipv6 access-list named TCP UDP filter`
- `show ipv6 access-list`

show ipv6 access-list

Use this command to display all configured hardware IPv6 access-lists or the IPv6 access-list specified by name.

Syntax `show ipv6 access-list [<access-list-name>]`

Parameter	Description
<code><access-list-name></code>	Hardware IPv6 access-list name.

Mode Privileged Exec

Example To show all configured ipv6 access-lists use the command:

```
awplus# show ipv6 access-list
```

Output Figure 51-1: Example output from the `show ipv6 access-list` command

```
IPv6 access-list deny_icmp
  deny icmp any any vlan 1

IPv6 access-list deny_ssh
  deny tcp abcd::0/64 any eq 22
```

Related Commands

- [ipv6 access-list named ICMP filter](#)
- [ipv6 access-list \(named\)](#)
- [ipv6 traffic-filter](#)
- [ipv6 traffic-filter](#)
- [ipv6 access-list named TCP UDP filter](#)

Chapter 52: Quality of Service (QoS)



Introduction.....	52.2
QoS Operations.....	52.2
QoS Packet Information.....	52.3
Link Layer QoS.....	52.3
Differentiated Services Architecture.....	52.4
The Differential Services Field.....	52.5
Processing pre-marked packets.....	52.6
Applying QoS on Your Switch.....	52.7
Classifying your Data.....	52.7
Class Maps.....	52.7
Policy Maps.....	52.10
Premarking your Traffic.....	52.11
CoS to egress queue premarking.....	52.12
DSCP to egress queue premarking.....	52.14
Policing (Metering) Your Data.....	52.16
Single-rate Three-color Policing.....	52.17
Two-rate Three-color Policing.....	52.18
Configuring and Applying a Policer.....	52.19
Remarking Your Data.....	52.20
Configuring the Egress Queues.....	52.22
Fabric queues - The Internal Paths.....	52.22
Egress Queues and QoS markers.....	52.22
Egress Queue Commands Hierarchy.....	52.23
Egress Queue Shaping.....	52.24
Scheduling.....	52.24
Drop Mode.....	52.26
Egress Queue Mapping.....	52.33
Storm Protection.....	52.35
QoS and the Switching Fabric.....	52.36
Policy-Based Routing.....	52.37
Practical Example.....	52.37

Introduction

This chapter introduces the concept of Quality of Service (QoS) with particular reference to Allied Telesis switches running the AlliedWare Plus™ Operating System. For additional information on using QoS on AT switches see, *How To Configure QoS on x900-24, x900-12, and SwitchBlade x908 Series Switches*. This How To Note is available from <http://www.alliedtelesis.com>.

The concept of QoS is a departure from the original networking concept of treating all network traffic in the same way. Without QoS, all traffic types are equally likely to be dropped when a link becomes oversubscribed. With QoS, certain traffic types can be given preferential treatment. QoS is therefore a very useful tool both to control congestion and to meter or cap data in order to apply pre-agreed service levels.

Operationally, QoS is applied within the link and network layers. Functionally it provides the capability to intelligently transport your network traffic in order to provide stable and predictable end-to-end network performance.

Business benefits Quality of Service mechanisms enable:

- network service providers to sell different levels of service to customers, based on what their customers require, and be confident in their ability to guarantee the reliable delivery of these services
- enterprise and educational organizations to actively manage and provide many services across one network, for example live video streaming and standard data services, with preferential treatment being given to mission-critical traffic
- network administrators to manage network congestion as network traffic levels increase and time-critical applications, such as streaming media, become more widely in demand by customers and organizations

QoS Operations

Quality of Service is typically based on how the switch performs the following functions:

- assigns priority to incoming frames (that do not already carry priority information)
- correlates prioritized frames with traffic classes, or maps frames to traffic classes based on other criteria
- correlates traffic classes with egress queues, or maps prioritized frames to egress queues
- provides minimum and maximum bandwidths for traffic classes, egress queues, and/or ports
- schedules frames in egress queues for transmission (for example, empty queues in strict priority or sample each queue)
- re-labels the priority of outgoing frames
- determines which frames to drop or re-queue if the network becomes congested
- reserves memory for switching/routing or QoS operation (for example, reserving buffers for egress queues or buffers to store packets with particular characteristics)

QoS Packet Information

Provision for QoS information to be embedded within the data fields exists within both the data link and network layer protocols. This information can then be used to assess the priority of the data and the resource preferences that need to be applied. The process of applying these service quality tags to your data is known as marking.

Link Layer QoS

Link layer frames entering a port may either be tagged or untagged. VLAN tagged frames contain the additional 802.1Q tag fields shown in [Figure 52-1 on page 52.3](#) below. Located within the TCI is a three bit User Priority field. This field is specifically provided to attach QoS based priority information, often referred to as the Class of Service (CoS) field.

Figure 52-1: IEEE 802.1Q Tagging

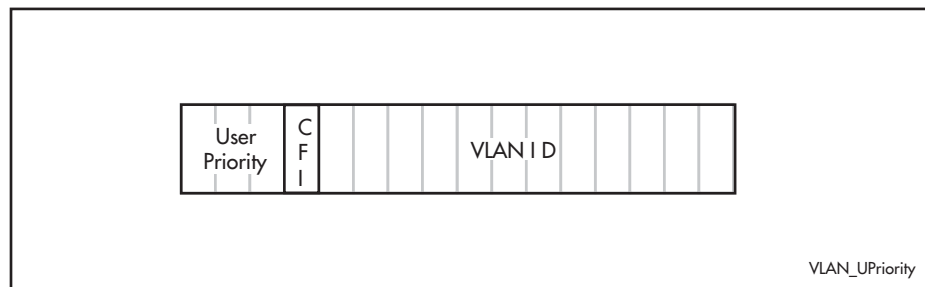

Appendix G of the IEEE Standard 802.1D provides some useful guidelines on applying priorities to 7 traffic types: These are summarized in the [Table 52-1](#) below:

Table 52-1: CoS Traffic Mapping Guidelines

User Priority	Traffic Types
1	Background
2	Spare
0	Best Effort
3	Excellent Effort
4	Controlled Load
5	Video <100 ms latency and jitter
6	Voice <10 ms latency and jitter
7	Network Control

On the switch you can use the command, [“match cos” on page 53.9](#) to select frames that match a particular User Priority value and assign them to a particular class-map. You can then map these incoming frames to one of eight egress queues. This facility enables you to accept frames that are already carrying meaningful priority information and automatically assign them to an appropriate egress queue. For example, you could decide to send frames with a User Priority value of 7 to queue 3, and frames with a User Priority value of 2 to queue 7. The process of assigning queues based on CoS tags is commonly known as “PreMarking”.

Note You configure the pre-marking steps to an ingress port. This process marks the data packets so that when they reach the egress port the decisions made during pre-marking can be applied in accordance with the configuration of the egress port.



Application with VLAN double tagging

Note that if you are using VLAN double tagging, you could use the “*match cos*” command to set the individual QoS requirements *within* each client network and also separately within the provider network. You can then use the “*match inner-cos*” on page 53.11 command to apply particular “*client*” QoS requirements that you want to apply within the provider network. This process applies two levels of QoS within the provider network; one that operates specifically for the network provider, and another that is specific for traffic belonging to selected clients. See “*VLAN Double Tagging (VLAN Stacking)*” on page 16.5.

At the network layer IPv4 packets contain an 8 bit field specifically to carry QoS information. This field, defined in RFC 1349, was originally named the Type of Service (ToS) field and contained a *ToS* component and a *Precedence* component. The ToS field however, has since been replaced by the Differentiated Services field.

Differentiated Services Architecture

Whilst a full description of the differential services model is outside the scope of this software reference, a brief introduction is provided. For further information, RFC 2475 provides an in depth definition of the architecture.

The basic differential services model envisages a multi router network within which common service qualities are applied. At the network boundary, *QoS Edge Routers* inspect the traffic and classify it into common service quality groups called Per Hop Behaviors (PHBs). A specific marker value called a Differential Services Code Point (DSCP) is added to the IP header of each packet, which allocates it to a PHB. *QoS Core Routers* within the network can then use the DSCP to decide on an appropriate service quality level to apply. When a network contains a consistently applied differential services code points DSCP it is referred as a Differential Services Domain (often shortened to DiffServe Domain). Figure 52-2 shows a simple Differential Services Domain.

Figure 52-2: Differentiated Services Domain

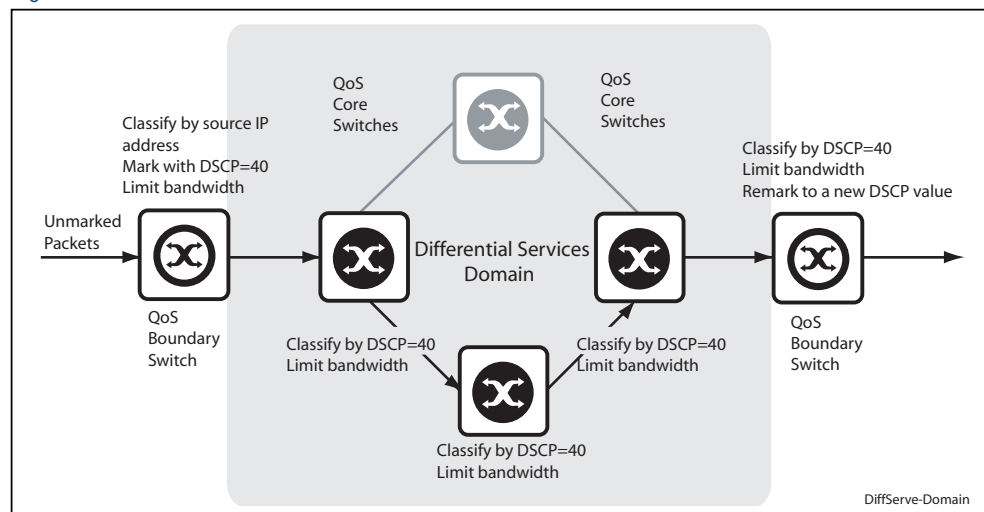

The Differential Services Field

Figure 52-3 shows an IP header containing a Differentiated Services field. The format of this redefined field is explained in RFC 2474; the main difference being that the old ToS field has been replaced by a 6 byte Differentiated Services Code Point (DSCP) field, which now provides for up to 64 defined values.

By applying this model only the QoS edge routers need to fully interrogate the incoming data packets; the QoS core routers are then relieved of this processing task and need only to inspect the DCSP before applying its appropriate forwarding, queueing, and shaping rules.

Figure 52-3: The DSCP bits of the DS field in the IPv4 header

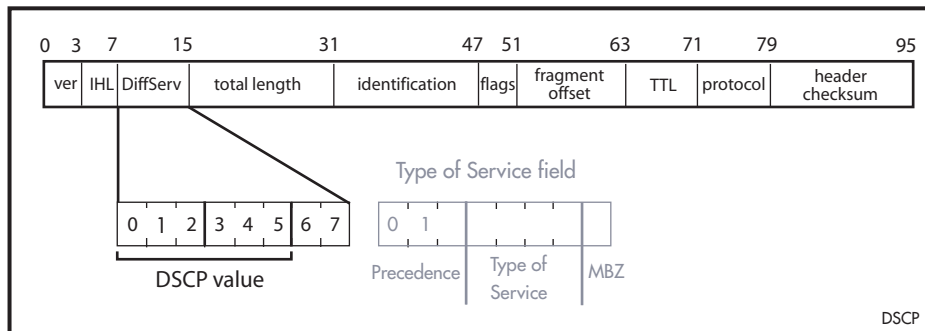

On the switch you can use the [match inner-vlan command on page 53.13](#) to select frames containing a particular DSCP value, and associate them with a particular class map and policy map. You can then use the [set queue](#) command to directly map these incoming frames to one of eight egress queues. This facility enables you to accept frames that are already carrying meaningful priority information to be automatically assigned to an appropriate egress queue. For example, you could decide to send frames with a User Priority value of 7 to queue 3, and frames with a User Priority value of 2 to queue 7.

Because the model offers considerable flexibility, and the mapping of traffic types to DCSPs is individual for each network, this locally applied definition is known as a *Differential Services Domain*. The previous section introduced the concept of a Per Hop (service quality) Behaviors or PHBs. RFC 2597 defines a specific PHB group called Assured Forwarding (AF). The AF PHB group provides delivery of IP packets in four independently forwarded AF classes. Within each AF class, an IP packet can be assigned one of three different levels of drop precedence.

Table 52-2 shows a list of recommended AF code points.

Table 52-2: Recommended DSCP Code Points

	(Lowest Priority) Class 1 (001xxxx)	Class 2 (010xxxx)	Class 3 (011xxxx)	(Highest Priority) Class 4 (100xxxx)
Low Drop Precedence	001010 AF11 Decimal 10	010010 AF21 Decimal 18	011010 AF31 Decimal 26	100010 AF41 Decimal 34
Medium Drop Precedence	001100 AF12 Decimal 12	010100 AF22 Decimal 20	011100 AF32 Decimal 28	100100 AF42 Decimal 36
High Drop Precedence	001110 AF13 Decimal 14	010110 AF23 Decimal 22	011110 AF33 Decimal 30	100110 AF43 Decimal 38

Processing pre-marked packets

A logical question to ask at this point is; how does the QoS switch deal with data that arrives with a pre-existing service level tag such as a DSCP? As previously touched on, the differentiated services model envisages a network that comprises QoS boundary routers at its edge and QoS core routers in its core network.

At the network edge the QoS boundary routers filter the incoming data based on specific packet components. Based on this filtering each packet is assigned a DSCP value. This value will determine the service level - priority, queueing etc - that will be applied.

Within the network core, the packet filtering required is reduced to simply reading the DSCP within each incoming packet, and applying a the appropriate set of service levels. This relieves the core routers of the processing overhead of applying complex filtering to its high speed data streams.

Applying QoS on Your Switch

This section steps you through the various stages of QoS set-up and introduces the QoS commands and how to apply them. Note that before you can configure any QoS functions on your switch, you must first enable QoS by using the [mls qos enable command on page 53.25](#).

Classifying your Data

One of the early steps in setting up QoS on a network is planning and applying your classification rules. Classification is the process of, *Filtering* and *Marking*. Filtering involves sorting your data into appropriate traffic types. Marking involves tagging the data so that downstream ports and routers can apply appropriate service policy rules. This process is known as *premarking*. [Figure 52-4](#) illustrates the classifying process, and will be referred to in the examples that follow.

Figure 52-4: QoS Classification Process

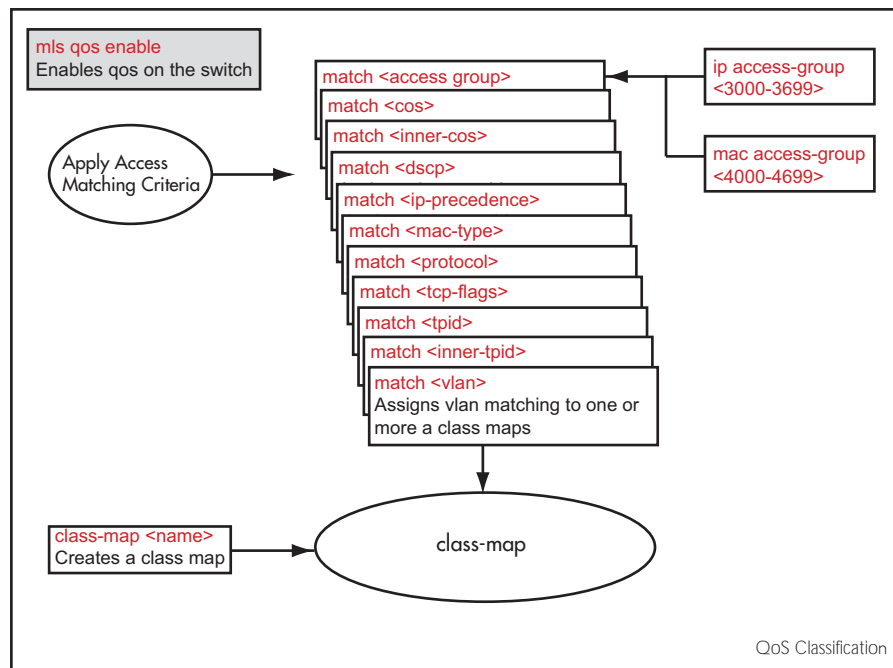

At the premarking stage you can assign your data a particular priority level by giving it a link level user priority, see [“Link Layer QoS” on page 52.3](#), or a network level DSCP [“Differentiated Services Architecture” on page 52.4](#). You can also assign the data to a particular output (or egress) queue.

Class Maps

Class Maps are among the pivotal QoS components. They provide the means that associate the classified traffic with its appropriate QoS actions. They are the linking elements for the following functions:

- classification
- policy mapping
- aggregate policing and metering
- pre-marking

Figure 52-5 on page 52.8 shows the relationship between a class-map and its associated functions. Note that the relationship between a class-map and a policy-map can be one-to-one or many-to-one. For information on policy-maps see the section, “Policy Maps” on page 52.10.

Note If a conflict occurs between the settings in two class maps, priority will be applied to the class map that was created first.

 An example of such a conflict is the arrival of a packet that meets the classification requirements of two class maps each configured to the same policy map and set to apply different priority settings to the packet.

Figure 52-5: Relationship between a class map and its associated functions



Creating a class-map

To create a class map, use the [class-map command on page 53.4](#).

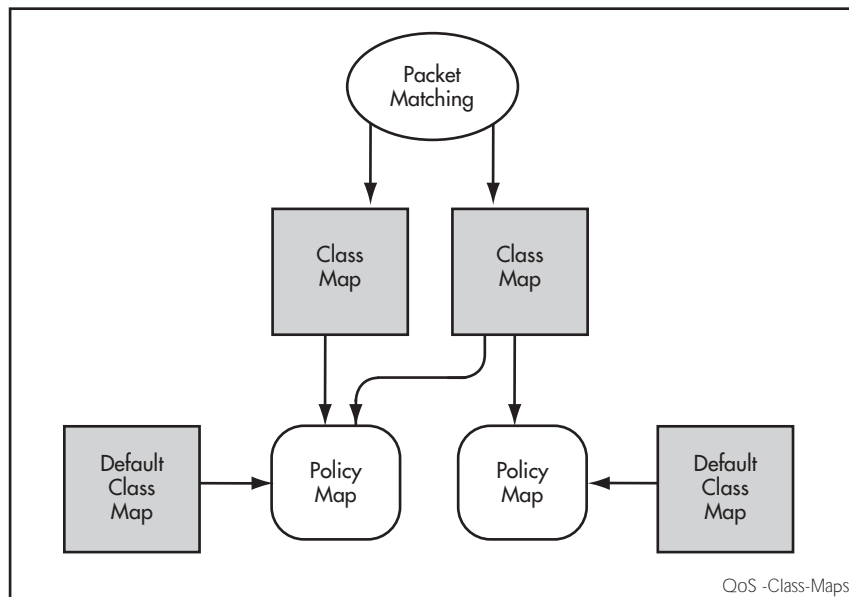
This example creates a class-map called video-traffic and another called data-traffic:

```
awplus# configure terminal
awplus(config)# class-map video-traffic
awplus(config-cmap)# exit
awplus(config)# class-map office-traffic
awplus(config-cmap)#
```

Creating and configuring default class-maps

These (automatically created) default class-maps serve as the means to specify the action that will apply to all unclassified data, i.e. all data within a policy-map that is not captured by any of the applied match commands that are applied to the policy-map by its class-maps.

Each time a new policy-map is created a new class map called "default" is also automatically created and assigned to the new policy map. You can configure any of the default class maps by using the [default-action command on page 53.5](#)

To set the default class-map for the policy-map *p-map1* to have the action of *deny*.

```
awplus# config
awplus(config)# policy-map p-map1
awplus(config-pmap)# default-action deny
```

Applying a match command to a class-map

To apply a matching filter to a class map use one of the match commands.

This example creates a filter to select vlan5 traffic and applies this filter to the class map named video-traffic.

```
awplus# config terminal
awplus(config)# class-map video-traffic
awplus(config-cmap)# match vlan 5
```

Associating a class-map with a policy-map

To associate a class map with a policy map, use the [class command on page 53.3](#).

Note A maximum of 128 class maps may be attached to each policy map.



The following example creates a policy map called policy-one, and associates it with the class-maps named video-traffic, and database-traffic:

```
awplus# configure terminal
awplus(config)# policy-map policy-one
awplus(config-pmap)# class video-traffic
awplus(config-pmap-c)# exit
awplus(config-pmap)# class database-traffic
awplus(config-pmap-c)#
```

Policy Maps

Policy maps are the means by which you apply your class-map properties to physical switch ports. [Figure 52-8 on page 52.18](#) illustrates this concept. Note that whilst a policy map can be assigned to several ports, a port cannot have more than one policy-map assigned to it.

Figure 52-6: Policy Maps and Related Entities

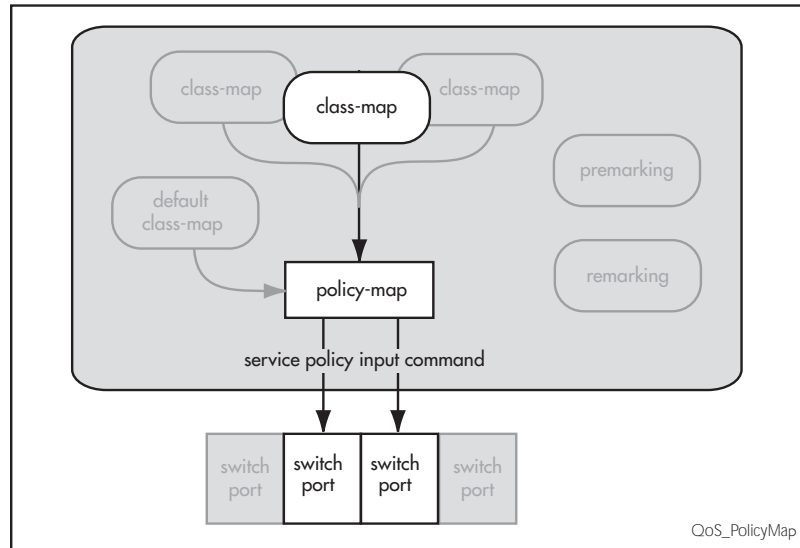

To create and name a new policy map you use the [policy-map command on page 53.48](#).

To create a policy-map called `pmap1` use the commands

```
awplus# configure terminal
awplus(config)# policy-map pmap1
```

Having created the policy map `pmap1` we can use the [class command on page 53.3](#) to assign it to one or more class maps. Since we created the class-maps `video-traffic` and `office-traffic` earlier in this chapter, we can now attach the policy-map `pmap1` to both class-maps.

Use the [class](#) command to assign the policy map `pmap1` to the class-maps `video-traffic` and `office-traffic`:

```
awplus# configure terminal
awplus(config)# policy-map pmap1
awplus(config-pmap)# class video-traffic
awplus(config-pmap-c)# exit
awplus(config-pmap)# class office-traffic
awplus(config-pmap-c)#
```

Premarking your Traffic

Premarking relates to adding QoS markers to your incoming data traffic before it is metered (policed). Remarking is the same process when applied after metering. Network switches will often be configured with two different premarking profiles, one for the QoS edge switches and another for the QoS core switches. This situation would apply if you are operating DSCP domains.

QoS markers can be applied at both the link layer (within the CoS field), and at the network layer (within the DSCP field). For more information on this topic see [“QoS Packet Information” on page 52.3](#).

For boundary QoS switches

Traffic entering QoS boundary switches is unlikely to contain pre-existing QoS tagging. In this case, you can apply one or more of the following QoS mapping options.

- Assign an output queue to data associated with a particular class-map (using the `set queue` command) and apply it to the input (*ingress*) port.
- Assign a CoS tag to data associated with a particular class-map. Using the `set cos` command. You can then map the CoS tag to an output (egress) port queue (using the `CoS to egress queue premarking` command).
- Assign a DSCP tag to data associated with a particular class-map (using the `set dscp` command). Alternatively, you can use the `trust dscp` command on page 53.75 to map the DSCP tag to an egress port queue, a CoS value, or both. At the premarking stage you can set this mapping using the command, `mls qos map premark-dscp to`. After policing, you can then use the remarking command `mls qos map policed-dscp to` in order to reassign a particular DSCP to a specific egress queue, CoS value, or both.

When no other mapping is set, all traffic is sent to the queue that is set by the `mls qos queue` command. If this command is unset (i.e. in the absence of any other queue selection) and the packet is untagged, traffic will be sent to queue 2.

For core QoS switches

Traffic entering ports within the QoS core network will almost certainly contain some pre-existing QoS tagging. Where this is the case, you can apply one of the following QoS mapping options.

- Map the CoS tag to an egress queue. You can do this either for the whole switch or for specific ports via their assigned policy-maps. See [“CoS to egress queue premarking” on page 52.12](#).
- Map the DSCP tag to an output queue. You can do this either for the whole switch or for specific ports via their assigned policy-maps. When no other mapping is set, all traffic is sent to the queue that is set by the `mls qos queue` command.
- Remap incoming data DSCP or CoS tags to values that are more appropriate for a particular switch or network.
- Assign bandwidth classes for your packets, based on the incoming DSCP. See [Setting the Trust DSCP Map command on page 52.15](#).

CoS to egress queue premarking

If you are using CoS tagging for your QoS functions, your traffic is likely to be either entering the switch with a pre-existing CoS tag, or will have appropriate tags attached via your class-maps and policy-maps. You can now mark the data for a particular egress queue, which will take effect when the data reaches its output port. There are two fundamental methods of applying CoS tagged packets to egress queues:

1. Apply a global mapping of CoS tags to egress queues for all ports.
2. Apply a CoS to egress queue mapping for the class-map / policy-map. This mapping - which forms part of the policy map - is applied at an input port, but will take effect at the packet's destination output port. Note that this procedure takes priority over that described in method (1) above.

These methods and their related commands will now be described in greater detail.

CoS tagging commands

A number of commands can be used to set or change the CoS tag mapping. [Table 52-3](#) shows the commands that can set or change the CoS tag within a packet.

Table 52-3: CoS Mapping Commands in Hierarchical Order

Command	Function
<code>set cos</code>	Assigns a CoS tag to a particular class-map / policy map.
<code>mls qos map premark-dscp to</code>	Where a packet contains CoS tag and a DSCP tag. The table set by this command contains a configurable DSCP to CoS tag mapping.
<code>mls qos map policed-dscp to</code>	Finally, the remarking function applied by this command can remap all previously set CoS tagging.

Where a packet entering a port contains a pre-existing DSCP, You can use the command `mls qos map policed-dscp to` to change the following components, DSCP tag, CoS tag, bandwidth class.

Note  Where a packet contains both a CoS and a DSCP field, and each field maps to a different class-map; the switch will apply a priority based on the creation date of the class maps to which they apply - the earlier the creation date, the higher the priority

Mapping CoS tags to traffic types

The command `mls qos map cos-queue to`, enables you to create a switch-wide mapping of CoS values to egress queues. The default mappings for this command are:

```

COS :           0 1 2 3 4 5 6 7
-----
QUEUE:         2 0 1 3 4 5 6 7
    
```

These mappings match the CoS guidelines documented in Annex H.2 of ANSI/IEEE 802.1D 1988 Edition. Table H-15 on page 355 of the standard, shows a table of user priorities for specific traffic types. [Table 52-4](#) shows an adapted version of the ANSI/IEEE table.

Table 52-4: Traffic Type Guidelines

User Priority (egress queue)	CoS Value	Acronym	Traffic type	Internal Traffic Queue Defaults
0 (lowest)	1	BK	Background	
1	2	-	Spare	
2	0	BE	Best Effort	Default
3	3	EE	Excellent Effort	
4	4	CL	Controlled Load	
5	5	VI	"Video," <100 ms latency and jitter	
6	6	VO	"Voice," <10 ms latency and jitter	EPSR-Management BPDU ARP-Requests
7 (highest)	7	NC	Network Control	Stack Management

CoS settings for VCS stack operation

In general you can apply the same principles when configuring QoS on a VCS stack as you would for single switch; however there are a few specific changes that you will need to make.

Switches within a VCS stack, exchange their stack management information and user data over their high speed inter-stacking links. The stack management information is pre-assigned to the egress queue 7. This is the highest value queue, and (in a stacked configuration) its traffic should not be shared with any user data. However, any CoS tagging of 7 applied to the incoming data will automatically be assign to queue 7 as it crosses the internal stacking links. You will therefore need to reconfigure your CoS to Queue settings to ensure that no user data is sent to queue 7.

To prevent this from happening, we recommend that you make appropriate changes to your queue settings (mappings) to reflect the stacking requirement previously described. For more information on this topic, see ["Mapping CoS tags to traffic types" on page 52.13](#).

This process should include (but not be limited to) running the following command to ensure that any remaining user still carrying a CoS 7 tag, will be mapped to egress queue 6.

To remap priority CoS traffic to egress queue 6, run the following command.

```

awplus# config terminal

awplus(config)# mls qos map cos-queue 7 to 6
    
```

DSCP to egress queue premarking

If you are using DSCP tagging for your QoS functions, your traffic is likely to be entering the switch either with a pre existing DSCP tag, or will have appropriate DSCP tags attached via your class-maps and policy-maps. You can now mark the data for a particular egress queue, which will take effect when the data reaches its output port.

If your switch forms part of a DSCP domain, you can adapt the steps in this section to apply the mappings and settings to match the standards you have selected for the domain. This mapping - which forms part of the policy map - is applied at an input port, but will take effect at the packet's destination output port.

DSCP to egress queue premarking commands

A number of commands can be used for mapping DSCP tags. Where these conflict, the switch applies a pre-defined set of priorities. [Table 52-5](#) lists these priorities in order (lowest priority first).

Where a packet that contains both CoS and a DSCP fields and each field maps to a different class-map / policy-map, the switch will apply a priority based on the creation date of class maps - the earlier the creation date, the higher the priority priorities.

Table 52-5: DSCP Mapping Commands in Hierarchical Order

Command	Function
<code>mls qos map policed-dscp to</code>	This remarking function can remap previously set dscp values and queue selections.
<code>set dscp</code>	With the trust dscp set, this command will change the dscp value in the packet.
<code>mls qos map premark-dscp to</code>	With the trust dscp set, this command applies a remapping table whose values include the dscp and egress queues.
<code>mls qos queue</code>	Sets a default egress queue for each individual port (or range of ports) on the switch.

If no overriding commands have been configured, and there is no CoS value in the packet, then the default setting of the `mls qos queue` command will send all data out via its port's egress queue 2. You can use the `mls qos queue` command to reset the egress queue for each port on the switch. If the packet does contain a CoS tag value, then this queue will be that shown in the mapping in the section ["Mapping CoS tags to traffic types"](#) on [page 52.13](#).

Setting the Trust DSCP Map

The Trust DSCP mapping table assigns a new set of QoS values for a DSCP value supplied as table input. To configure this table you use the command, `mls qos map premark-dscp to`.

Table 52-6: Drop Probability Table

Table Input	Table Output			
Existing DSCP	New DSCP Value	New CoS Value	New Queue No	New BW Class green yellow red

The Trust DSCP map is configured from the `mls qos map premark-dscp to` command and provides the highest priority of all the pre-marking controls. To apply this table you must first apply the trust setting by using the command `trust dscp`.

At this point the DSCP input to the table will be that existing in the incoming packet. However, by setting the `set dscp` you can change the DSCP for all packets within the specified class-map or policy-map (for XEM-2XP) specified. Note, that with the trust DSCP set, the DSCP value that is used for table lookup will depend on the applied port's platform type:

- on switch ports belonging to a XEM-2XP lookup is on the DSCP of the incoming packet.
- on switch ports other than the XEM-2XP, lookup is on either the DSCP of the incoming packet, or the DSCP applied to the selected class-map (i.e. that set by the `set dscp` command on page 53.52).

Policing (Metering) Your Data

Once you have set-up your classification and created your class-maps, you can start conditioning your traffic flows. One tool used for traffic conditioning is the policer (or meter). The principle of policing is to measure the data flow that matches the definitions for a particular class-map; then, by selecting appropriate data rates, allocate the flows into one of three categories, Red Yellow or Green. You then decide what action to apply to the Red, Yellow and Green data.

Two metering types can be configured from the [mls qos aggregate-police action command on page 53.22](#), these types are:

- [single-rate three-color](#)
- [twin-rate three-color](#)

Note that although the color marking process is carried out on the input port (on ingress), the egress port can also use this color marking to modify its output data flows. The meter operates in the color aware mode; however the premarker that precedes it senses all input data as being green. Note that all external data entering a switch port is considered to be marked green. This means that unless you have re-colored your data at the premarking stage - by using the [set bandwidth-class command on page 53.50](#) - the data entering the meter will be green.

The metering levels, CIR, CBS etc are defined within a policer. This class-map (along with others) is then added to a policy-map, which in turn is attached to a port.

Single-rate Three-color Policing

This policing method is based on that defined in RFC 2697. The principle of single-rate three-color policing is shown in Figure 52-7. For a given class-map, a meter monitors both the token count in the buckets, and the input data flow.

Figure 52-7: Single-rate Three-color Policing

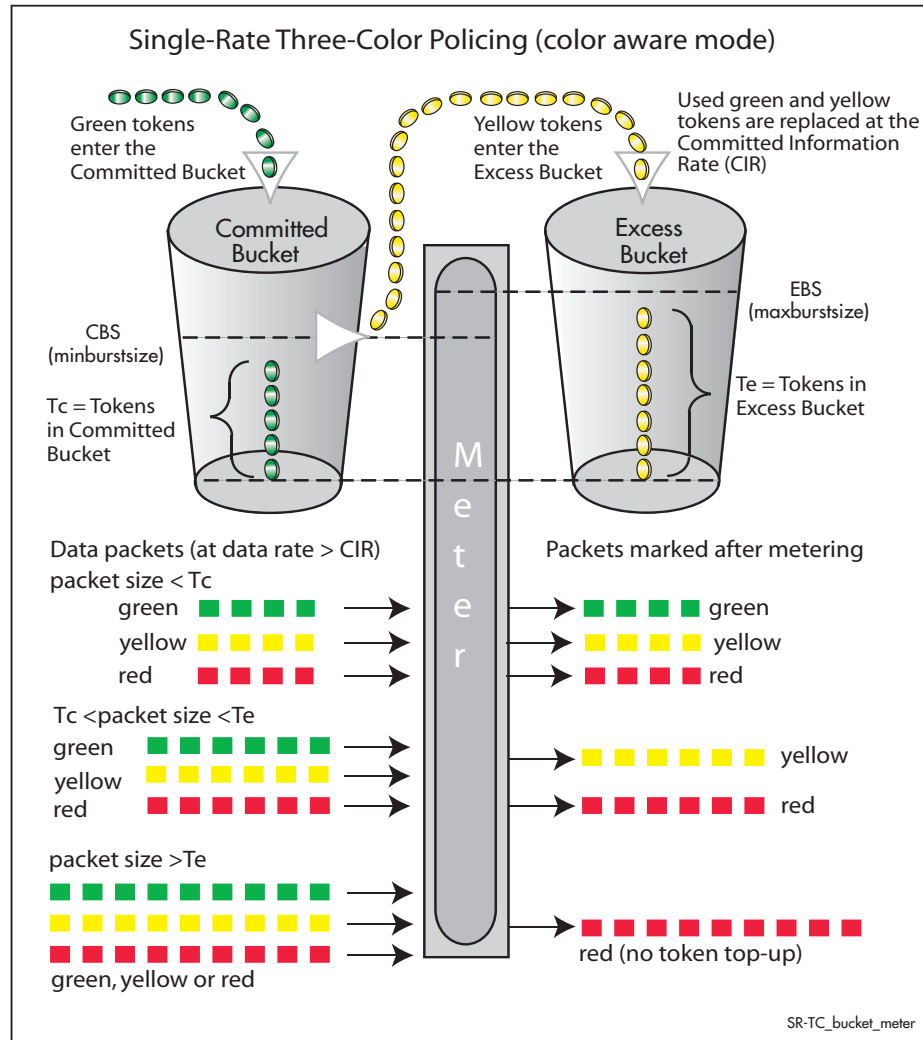

Each byte entering the meter is paired with a token in one of the buckets, and a token is removed as each byte is accepted. If the input data rate is the same as the CIR then the data passes through the port at the same rate as its bucket fills. Hence the bucket level remains constant. In this model, the data buffer is represented by two data buckets. You can specify the CIR using the `police single-rate action` command.

Initially both buckets have their full token count. A surge of data exceeding the CIR will begin to empty the bucket. As the data and tokens are paired, data bytes that match tokens below the CBS level are marked green, those that are between CBS and EBS will be marked yellow, and those that are above EBS are marked red.

Note that although the data is metered per byte, the color marking process is applied per packet. This means that if there were only sufficient tokens available to match part of a packet, then the whole packet would be marked red. Then, depending on the **action** parameter of the `police single-rate action` command, the whole packet will be either dropped or forwarded. In either situation, the red marked packet will leave the bucket counts unchanged.

Two-rate Three-color Policing

This policing method is based on that defined in RFC 2698. The principle of two-rate three-color policing is shown in Figure 52-8.

Figure 52-8: Two-rate Three-color Policer

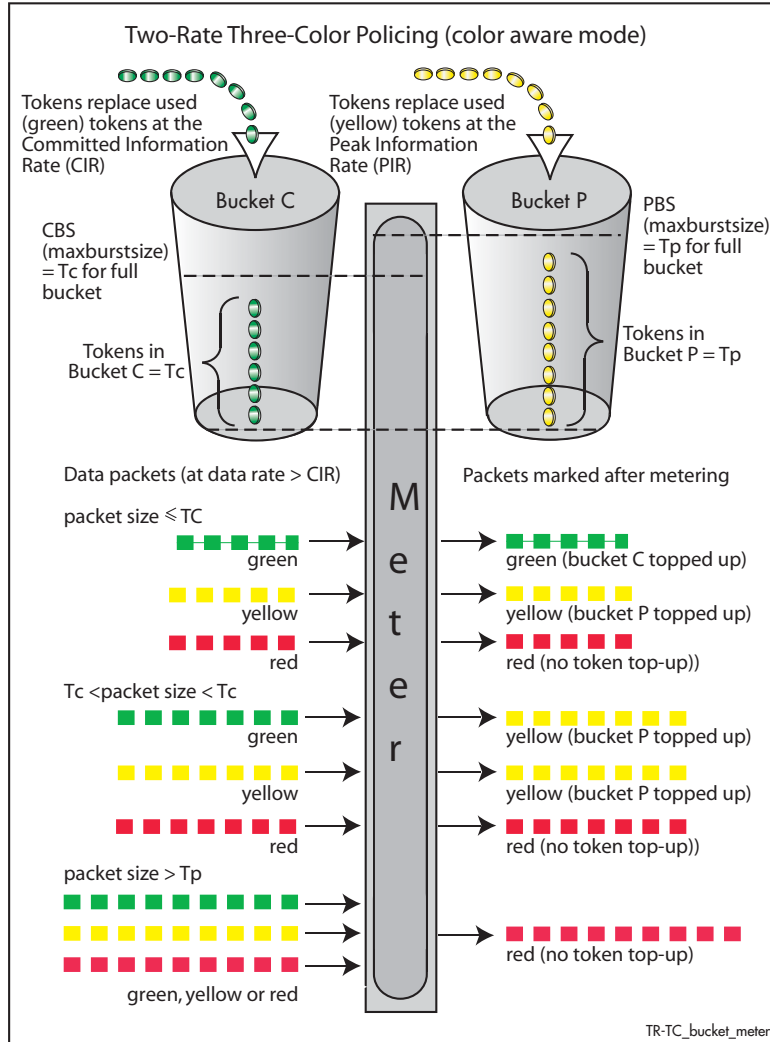

For a given class-map, the meter monitors the token count in both buckets, and the input data flow. Initially tokens enter both buckets until full. As the data enters a port, the meter pairs each byte to a token in one of the buckets, then removes a token from the appropriate bucket. Bucket C is topped up with tokens at the Committed Information Rate (CIR), and bucket P is topped up at the Peak Information Rate (PIR).

When data enters the port at the CIR, the bucket fills at the same rate as the incoming data, thus the token count in bucket C remains constant. Similarly, if data enters the port at the PIR, then the token count in bucket P remains constant. You can specify the CIR and the PIR by using either the `police twin-rate action drop-red` command or the `mls qos aggregate-police action` command. The function of each of these commands is explained in the section “Configuring and Applying a Policer” on page 52.19.

A surge of data exceeding the CIR will begin to empty bucket C. If bucket C empties to a point where it has insufficient tokens to match to an incoming data packet, then the data packet will be marked yellow. The data will now be measured against the level in bucket P and tokens will be removed from this bucket to match the incoming data. If the incoming data rate drops to less than the CIR then the data will continue to be marked yellow until the level in bucket C has had a chance to fill, whereupon it will be marked *green*.

If the incoming data is greater than the PIR, then bucket P begins to empty. If bucket P empties to a point where it has insufficient tokens to match to an incoming data packet, then the data packet will be marked *red*. In this situation no tokens are removed from either bucket.

Note that although the data is metered per byte, the color marking process is applied per packet. This means that if there were only sufficient tokens available to match part of a packet, then the whole packet would be marked red. Then, depending on the **action** parameter of the `police twin-rate action drop-red` command, the whole packet will be either dropped, or marked and forwarded. In either situation, the red marked packet will leave the bucket counts unchanged.

Configuring and Applying a Policer

The previous section showed how the policer works and how to select either the single rate or twin rate action. There are two methods to apply a policy to class maps.

1. Select your policy-map and class-map from the command prompt, then enter either the `police single-rate action` command or the `police twin-rate action drop-red` command whilst selecting the appropriate command parameters.

This will apply the command to the selected class-map. By running this command several times, each for a different class-map, you can apply separate meter settings to each class-map.

2. Use the `mls qos aggregate-policer` action to create a "named" aggregate policer whilst selecting the appropriate command parameters. Once you have done this, you can use the `police aggregate` command to apply the aggregator to the policy-map and class-map selected from the command prompt. Note that you cannot apply an aggregate policer to a class map that has already been attached to a policer by using either the `police single-rate action`, or the `police twin-rate action drop-red` commands.

The main difference between these two methods is that you use method (1) to apply policing to a number of class-maps, each having its own individually configured meter settings; whereas you use method (2) to apply policing to a number of class-maps and police them all using a single meter setting.

Note  A set of class-maps that contribute traffic into a given aggregate policer can belong to different policy-maps. This means that the aggregate policer can meter packets destined for different egress ports.

Remarking Your Data

The remarking process enables you to change the QoS tagging and queue assignments etc from data that has already been marked by the policer. To do this you fill entries in the remarking table by using the [mls qos map policed-dscp to command on page 53.31](#). In order to remark your data ensure that the **action** parameter of either the [police single-rate action](#) or the [police twin-rate action drop-red](#) is set to **policed-dscp-transmit**.

The following table shows the remarking options

Table 52-7: Remarking Options

Existing DSCP	BANDWIDTH CLASS		
	Green	Yellow	Red
DSCP value in the packet leaving the meter	New value for Dscp New value for CoS Tag New bandwidth class (Red, Yellow, or Green) New value for egress queue	New value for Dscp New value for CoS Tag New bandwidth class (Red, Yellow, or Green) New value for egress queue	New value for Dscp New value for CoS Tag New bandwidth class (Red, Yellow, or Green) New value for egress queue

Example Traffic whose existing DSCP value is 15 and has its data marked either Green, Yellow or Red is to be remarked to have its existing policed green traffic tagged as follows:

- « new DSCP of 20
- « new CoS of 3
- « new queue of 4
- « new bandwidth class of yellow

Table 52-8: Remarking Table Example

DSCP	BANDWIDTH CLASS		
	Green	Yellow	Red
Existing dscp = 1	Remapping for DSCP 1	Remapping for DSCP 1	Remapping for DSCP 1
...	Remapping for DSCPs 2 to 14	Remapping for DSCPs 2 to 14	Remapping for DSCPs 2 to 14
Existing dscp = 15	New DSCP = 20 New CoS Tag = 3 New bandwidth class = Yellow New egress queue = 4		
...	Remapping for DSCPs 2 to 62	Remapping for DSCPs 2 to 62	Remapping for DSCPs 2 to 62
Existing dscp = 63	Remapping for DSCP 63	Remapping for DSCP 63	Remapping for DSCP 63

To configure this setting, you would enter the following commands:

```
awplus# config terminal
awplus(config)# mls qos map policed-dscp 15 bandwidth-class
green to new-dscp 20 new-cos 3 new-queue 4
new-bandwidth-class yellow
```

Configuring the Egress Queues

Previous sections have explained the ingress functions. These include, how the incoming data can be classified and marked according to its priority and allocated to an egress queue, then finally how metering and remarking is applied. At this point the data then flows across the switch to its destination egress port where its transit to the egress queues is controlled.

The means by which data is applied to the egress queues is dependant on three functions:

- Egress queue and QoS markers that are set within each data packet
- Egress controls that are applied to the whole switch
- Egress that are applied to each individual switch port

Fabric queues - The Internal Paths

Although the internal hardware functions of the switch are outside the scope of this manual, the section, "[QoS and the Switching Fabric](#)" on page 52.35 provides some background information to help you understand and use the `mls qos fabric-queue` command. Basically, the internal path that links the fabric adaptors terminates in four fabric queues. These queues schedule the data between the internal fabric adaptors and each port's egress queue.

The `mls qos fabric-queue` command, mentioned above, enables you to select the scheduling algorithm to be either strict priority, or weighted round robin (WRR). Use the `show mls qos fabric-queue` to see the present settings on your switch.

The `mls qos fabric-queue` command enables you to map the egress queues to 4 internal processor fabric queues. The commands section provides more information such as their default settings and how to reconfigure them. Use the `mls qos fabric-queue` to see the present settings on your switch.

Egress Queues and QoS markers

Once the data packets have been appropriately filtered, classified, policed, and remarked, they travel across the switch's internal paths carrying their assigned QoS tag markers such as their priority, class and destination queues. For more details on ingress data marking, refer to the earlier sections of this chapter. At the egress port these markers are read and used to determine which queues each data packet will be forwarded to, and the priorities that will be applied.

There are eight egress queues allocated to each egress port. The egress queue that a particular packet passes through is determined by either the configuration of the switch, or the markers contained within the packet itself.

Figure 52-9: Default Egress Queue

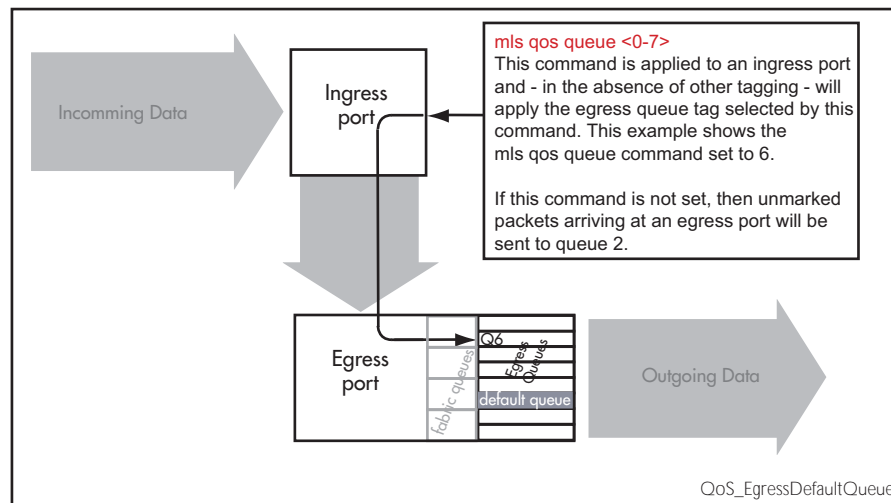

Egress Queue Commands Hierarchy

The destination queue that any one packet will take depends on the markers within the packet, and the way the queueing commands have been set. Also some queueing commands will override others. Here is how the switch prioritizes its queueing commands.

Imagine a packet entering an ingress port then traveling through the switch fabric to reach its appropriate egress port. In this situation the following hierarchy will apply:

1. If the packet enters an egress port carrying no QoS markers and no QoS queueing commands have been set on the switch, then the packet will exit the port via queue number 2.
2. If the packet containing CoS marker arrives at an egress port, then with no other configuration applying, then its queue mapping will be subject to the setting of the command, `mls qos map cos-queue to`.
3. Situations (1) and (2) can be overridden by the `mls qos queue` command. This command sets a default queue for each switch port.
4. If the `set queue` command has been applied to specific ports via its class-map / policy map combination, then the queue mapping of this command will override that set by the `mls qos queue` command for those specific ports.
5. If the `trust dscp` then the egress queue assignment will be based on the entries in the `mls qos map`, which is set by the command, `mls qos queue`. This mapping table will override all the previous commands in this list.
6. Finally all the above mappings may be modified by the remarker, by using the `mls qos map policed-dscp to`.

Egress Queue Shaping

This section is concerned with how the egress queues are cleared. It does NOT apply to ports on the XEM-2XP module.

There are two aspects to queue shaping:

- Scheduling (strict priority or weighted round robin)
- Drop Mode (tail-drop or weighted early discard)

Scheduling

The scheduler determines how packets in the eight egress port queues are serviced. Two servicing methods can be applied:

- strict priority
- weighted round robin

Strict priority servicing

By default, all queues on all ports are serviced in a strict priority order. This means that the highest numbered priority queue (queue 7) is emptied first; then when it is completely empty, the next highest priority queue is processed, and so on. Thus, for a strict priority queue to be processed, all higher priority queues must be empty.

Strict priority servicing is the default setting; however if your system is configured for weighted-round-robin, you can return it to priority queueing by using the commands shown in the following example.

Example To return queue 3 of port 1.0.1 from WRR servicing to strict priority queueing:

```
awplus# configure terminal
awplus(config)# interface port1.0.1
awplus(config-if)# priority-queue 3
```

Weighted round robin servicing

Two round robin groups can be configured. Using this configuration, all packets in group 1 are serviced first, using the weights specified for the group 1 queues. Once all queues in group 1 are empty, the queues in group 2 are serviced using the weights specified for the group 2 queues. Note that if some queues on the port have also been configured for strict priority, the strict priority queues must be empty before the first weighted round robin group will be serviced.

Example To configure wrr-queue group 1 applying a weighting value of 6 to queues 0 1 2:

```
awplus# configure terminal
awplus(config)# interface port1.0.1
awplus(config-if)# wrr-queue group 1 weight 6 queues 0 1 2
```

Example To configure wrr-queue group 2 applying a weighting value of 12 to queues 3 4 5:

```
awplus# configure terminal
awplus(config)# interface port1.0.1
awplus(config-if)# wrr-queue group 2 weight 12 queues 3 4 5
```

Example In this example port 1.0.1 has queues configured as follows:

- queues 6 and 7 are configured strict priority
- queues 3, 4 and 5 are WRR group 1 with weighting values of 6, 6 and 12 respectively
- queues 0, 1 and 2 are WRR group 2 all with a weighting value of 6

```
awplus# configure terminal
awplus(config)# interface port1.0.1
awplus(config-if)# priority-queue 6 7
awplus(config-if)# wrr-queue group 1 weight 6 queues 3 4
awplus(config-if)# wrr-queue group 1 weight 12 queues 5
awplus(config-if)# wrr-queue group 2 weight 6 queues 0 1 2
```

In this example, the queues are processed as follows:

1. Queue 7 is processed first.
2. If queue 7 is empty, Queue 6 is processed next.
3. If queues 6 and 7 are empty, queues 3, 4 and 5 are processed with a ratio of 1:1:2.
4. If queues 4 to 7 are empty, queues 0, 1 and 2 are process with equal weighting.

Drop Mode

Note that this section does not apply to ports on the XEM-2XP

The drop mode sets the limits for packets in the eight egress queues and determines how packets will be dropped if the queues become congested. Two drop methods may be employed, these are:

- Tail Drop
- Weighted Random Early Discard (WRED)

For both the above methods there are 4 pre-existing queue-sets numbered 1-4. You can configure each queue-set with a separate drop mode profile for each of the 8 egress queues.

Your switch has 4 pre-existing queue-sets, one pre-configured for 1G ports and another for 10 G ports. These configurations are shown in [Table 52-10 on page -27](#) and [Table 52-11 on page -28](#). You can name and reconfigure these profiles and change the association of queue sets to switch ports. These steps are explained later in this section.

 **Note** The default drop mode operation is Tail Drop. In this situation the value set by the `mls qos queue-set drop-probability` command is ignored, and a drop value of 0 (i.e 100%) is internally applied. Also the value set for the minimum threshold is ignored, and the averaging factor is replaced by an instantaneous comparison of queue size with the maximum threshold figure (Maxth).

Figure 52-10: Queue-Set Defaults for 1G Ports

```
awplus#show mls qos queue-set
```

Queue Set 1:
Description: 1G Defaults

	BandwidthClass	Min	Max	Drop Probability
Queue 0	Green	100 KB	125 KB	1 (50%)
	Yellow	100 KB	125 KB	1 (50%)
	Red	100 KB	125 KB	1 (50%)
Queue 1	Green	100 KB	125 KB	1 (50%)
	Yellow	100 KB	125 KB	1 (50%)
	Red	100 KB	125 KB	1 (50%)
Queue 2	Green	100 KB	125 KB	1 (50%)
	Yellow	100 KB	125 KB	1 (50%)
	Red	100 KB	125 KB	1 (50%)
Queue 3	Green	100 KB	125 KB	1 (50%)
	Yellow	100 KB	125 KB	1 (50%)
	Red	100 KB	125 KB	1 (50%)
Queue 4	Green	100 KB	125 KB	1 (50%)
	Yellow	100 KB	125 KB	1 (50%)
	Red	100 KB	125 KB	1 (50%)
Queue 5	Green	100 KB	125 KB	1 (50%)
	Yellow	100 KB	125 KB	1 (50%)
	Red	100 KB	125 KB	1 (50%)
Queue 6	Green	100 KB	125 KB	1 (50%)
	Yellow	100 KB	125 KB	1 (50%)
	Red	100 KB	125 KB	1 (50%)
Queue 7	Green	100 KB	125 KB	1 (50%)
	Yellow	100 KB	125 KB	1 (50%)
	Red	100 KB	125 KB	1 (50%)

Queue Length Averaging Factor

- Queue 0: 9
- Queue 1: 9
- Queue 2: 9
- Queue 3: 9
- Queue 4: 9
- Queue 5: 9
- Queue 6: 9
- Queue 7: 9

Figure 52-11: Queue-Set Defaults for 10 G Ports

```

Queue Set 2:
Description: 10G Defaults

-----
          BandwidthClass  Min           Max           Drop Probability
-----
Queue 0  | Green                1 MB          1 MB          1 (50%)
          | Yellow                1 MB          1 MB          1 (50%)
          | Red                   1 MB          1 MB          1 (50%)
-----
Queue 1  | Green                1 MB          1 MB          1 (50%)
          | Yellow                1 MB          1 MB          1 (50%)
          | Red                   1 MB          1 MB          1 (50%)
-----
Queue 2  | Green                1 MB          1 MB          1 (50%)
          | Yellow                1 MB          1 MB          1 (50%)
          | Red                   1 MB          1 MB          1 (50%)
-----
Queue 3  | Green                1 MB          1 MB          1 (50%)
          | Yellow                1 MB          1 MB          1 (50%)
          | Red                   1 MB          1 MB          1 (50%)
-----
Queue 4  | Green                1 MB          1 MB          1 (50%)
          | Yellow                1 MB          1 MB          1 (50%)
          | Red                   1 MB          1 MB          1 (50%)
-----
Queue 5  | Green                1 MB          1 MB          1 (50%)
          | Yellow                1 MB          1 MB          1 (50%)
          | Red                   1 MB          1 MB          1 (50%)
-----
Queue 6  | Green                1 MB          1 MB          1 (50%)
          | Yellow                1 MB          1 MB          1 (50%)
          | Red                   1 MB          1 MB          1 (50%)
-----
Queue 7  | Green                1 MB          1 MB          1 (50%)
          | Yellow                1 MB          1 MB          1 (50%)
          | Red                   1 MB          1 MB          1 (50%)
-----

Queue Length Averaging Factor
Queue 0: 9
Queue 1: 9
Queue 2: 9
Queue 3: 9
Queue 4: 9
Queue 5: 9
Queue 6: 9
Queue 7: 9

```

Assigning a queue-set description

You can use the `mls qos queue-set description` command to assign each of the queue-sets with an appropriate description. For example, you could name your triple-play traffic "Triple-Play" as shown below. You could then assign appropriate profiles for each of 8 triple-play queues within the queue-set.

Example To set the description for queue-set 4 to be "Triple-Play," use the command:

```
awplus# config terminal
awplus(config)# mls qos queue-set 4 description "Triple-Play"
```

Once you have configured your queue-sets, you can apply each to specific ports by using the `mls qos queue-set`. You also use this command to select the drop-mode to apply.

Note the following rules when applying queue-sets to queues and ports:

- a port can only have one queue-set applied to it
- a queue-set can be applied to many ports

Example To set port 1.0.1 to use queue-set 2 in random-detect mode, use the command:

```
awplus# config terminal
awplus(config)# interface port1.0.1
awplus(config-if)# mls qos queue-set 2 random-detect
```

Tail Drop

Note that this section does not apply to ports on the XEM-2XP

In this drop mode each egress queue is configured with a maximum threshold value. This value represents the point where the egress buffer queues are full and the egress port must start dropping data. The port does this by dropping data packets destined for the full queue on a "last in first dropped" basis. This enables the port to clear its data already queued for egress.

If a "reliable" transport protocol, such as TCP is used, this data should be retransmitted, but at a slower rate due to lack of returning "acknowledgements". The queue threshold value is set using the `mls qos queue-set threshold` command.

Tail drop is far simpler to configure than its alternative random-detect (RED) and in most situations offers similar performance. In some situations, such as when using the UDP protocol, it is more appropriate to use tail-drop than RED. This is because UDP (unlike TCP) is not a sliding window protocol. UDP is also a popular protocol for "real time" data such as voice and video conferencing. The defaults for tail-drop are shown in [Figure 52-10 on page 52.27](#) and [Figure 52-11 on page 52.28](#).

Note  The default drop mode operation is Tail Drop. In this situation the value set by the `mls qos queue-set drop-probability` command is ignored, and a drop value of 0 (i.e 100%) is internally applied. Also the value set for the minimum threshold is ignored, and the averaging factor is replaced by an instantaneous comparison of queue size with the maximum threshold figure (Maxth).

To reset a port from RED drop-mode to tail drop mode, use the command `mls qos queue-set`.

Example To set port 1.0.1 to tail-drop to use the command:

```
awplus# config terminal
awplus(config)# interface port1.0.1
awplus(config-if)# mls qos queue-set 2 taildrop
```

Random Early Detection (RED)

Note that this section does not apply to ports on the XEM-2XP

This drop mode was developed as a more graceful way of managing queue congestion than that obtained using the tail-drop method described in the previous section. RED is however far more complex to configure than tail-drop. As previously mentioned, in some situations, such as when using the UDP protocol, it is more appropriate to use tail-drop than RED. This is because UDP (unlike TCP) is not a sliding window protocol and so dropping packets does nothing to slow the incoming data flow. Because UDP is also a popular protocol for “real time” data such as voice and video conferences, dropping packets as the egress queue fills, can result in unnecessary performance degradation of the end-user application.

AlliedWare Plus™ enables you to create different RED curves for each traffic class. This feature is known as Weighted Random Early Detection (WRED).

The defaults for WRED configuration are shown in [Figure 52-10 on page 52.27](#) and [Figure 52-11 on page 52.28](#).

Random early detection operates in a similar way to tail drop but begins to (gracefully) drop packets as the *average queue length*¹ approaches the Maximum threshold point (Max_{th}). The concept is illustrated in [Figure 52-12 on page 52.31](#). This figure shows how packets in the three classes, Red, Yellow, and Green are progressively dropped as their egress queue begins to fill.

Each queue has an allocated buffer size, illustrated in the figure by the *MAX queue length on the graph's x axis*. Traffic entering the queue can be marked either Green (most conformant), Yellow, or Red (least conformant). As the queue length increases it will first reach point Min_{th} Red the minimum threshold for Red traffic. At this point the port begins to drop some of its red class traffic. If the current data flow continues and the queue continues to fill, traffic is dropped in increasing amounts. The vertical axis of the graph shows the probability of a packet being dropped.

1. The following equation is used to calculate the average queue length (Q_{ave}):

$$Q_{ave} = [(1 - 1/2^n) * Q_{ave}] + [1/2^n * (Current\ queue\ length)]$$

Where n = the averaging factor

See the `mls qos queue-set averaging-factor` command on page 53.38.

Figure 52-12: Random Early Detect - Drop Profile

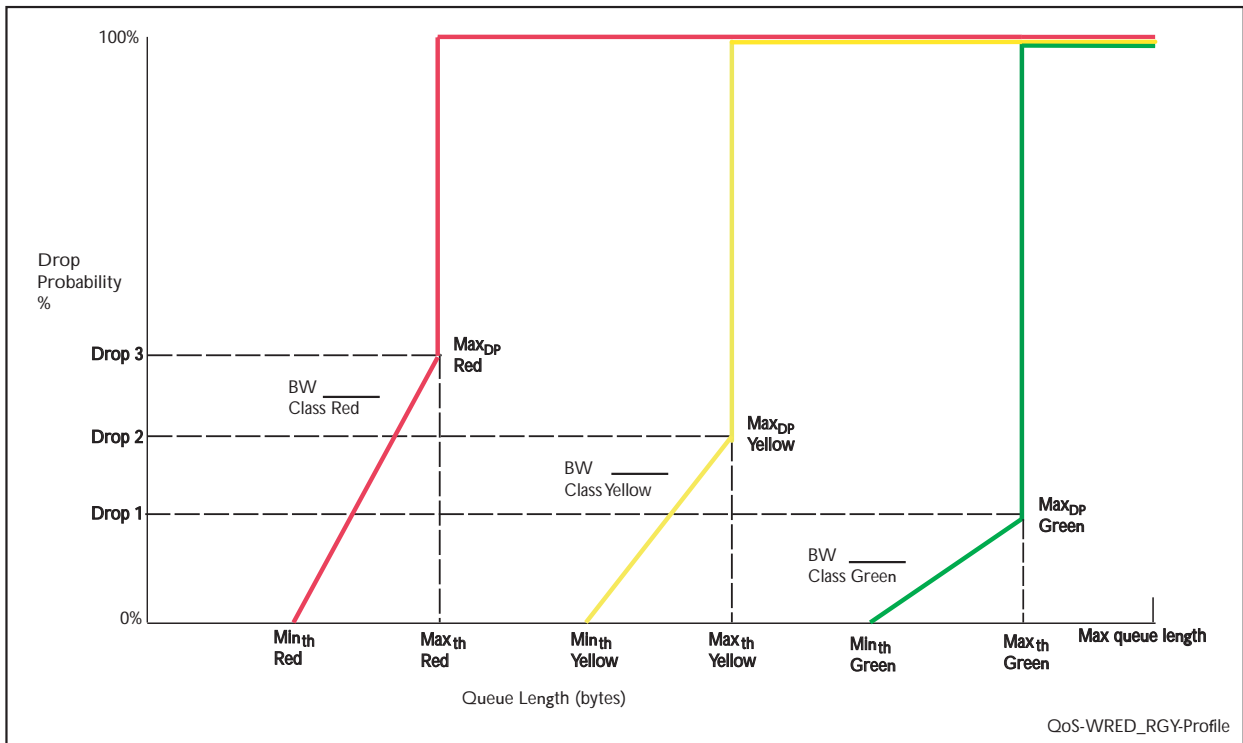

As the buffer further increases it will reach the point Max_{th} . At this point the drop probability is at the point Max_{dp} on the chart's vertical axis. From this point on, any further increase in queue size results in all packets in red traffic being dropped. This should increase the queue space for the remaining yellow and green traffic.

If the queue continues to fill, the above situation will then apply to the yellow and green traffic, as the queue size meets their own configurable thresholds Min_{th} yellow, Max_{th} yellow etc. Setting these thresholds is covered in "Configuring Tail Drop and Random Early Detection" on page 52.31.

Configuring Tail Drop and Random Early Detection

Note that this section does not apply to ports on the XEM-2XP

As previously mentioned the defaults for both drop methods can be seen from [Figure 52-10 on page 52.27](#) and [Figure 52-11 on page 52.28](#). These tables show the same output for both tail-drop and RED detection methods. However, when tail-drop is applied the values for Min_{th} and average queue length (Q_{ave}) are ignored, and the drop probability is either 0 (for a current queue size $<Max_{th}$) or 100% for a current queue size $>Max_{th}$.

The defaults shown are simply factory presets and are not intended to produce a functional configuration. The information in this section is to provide the basic guidelines required for you to set-up a tail-drop or RED detection method based on you own QoS standards.

Some Rules and Guidelines for the x.900 and SwitchBlade® x908 series switches.

- Each port on your switch will be a member of a single switch processor instance: All ports within a XEM are members of the same processor instance. On 24 port

switches, such as the x900-24 series, ports 1-12 and ports 13-24 belong to separate processors.

- Each port contains 8 egress queues; these share the total queue buffer space allocated for the port. The per port upper limit is:
 - « 1.8 MB when configured for normal size frames
 - « 8.25 MB when configured for Jumbo frames
- Each processor instance has the following buffer limits:
 - « When the switch is configured for normal frames, 8.2 MB is shared between its ports. For a 12 port processor, the buffer limit = $0.68 \text{ MB}_{\text{avg}}$ per port, and for a single port processor, such as a XEM, the buffer limit is 8.2 MB.
 - « When the switch is configured for jumbo frames 32 MB is shared between its ports. For a 12 port processor, the buffer limit = $2.6 \text{ MB}_{\text{avg}}$ per port. For a single port processor, such as a XEM, the buffer limit = 32 MB.

Note  For each queue-set, use the [wrr-queue queue-limit command on page 53.80](#) to allocate the buffer size for each of a ports 8 egress queues (see note below), then select suitable threshold values for each of the classes Red, Yellow, and Green for each queue. See [mls qos queue-set threshold command on page 53.41](#).

When setting the [wrr-queue queue-limit](#) command, we recommend setting the average queue length for a maximum queue ratio of 37% across all used queues on the particular port (i.e. 4.62% per queue when using 8 queues). This will provide 667 KB per port (83 KB per queue) when the switch is set for normal frame sizes; and 3.1 MB per port (388 KB per queue) when the switch is set to support Jumbo frames. You can then use these values to form the basis for setting the Maxth value for your Green traffic. Once you have set the Maxth Green you can work back from this point to choose appropriate values for your Red and Yellow traffic.

At this point you should be ready to apply your configurations using tail-drop. If you want to use RED you will need to take the following additional steps. Configuring RED for more than a marginal performance advantage over tail-drop, will require a good understanding of RED configuration principles and of your networks traffic profiles and service quality expectations. The following steps are intended to configure a basic RED system using some rule-of-thumb settings. You will probably want to fine tune these settings for real traffic profiles.

- Using the Drop Probability Table below, select an appropriate value for the maximum drop probability value for each of the colors. For TCP traffic we suggest using a drop probability of 3 or 4. For Green traffic using UDP we suggest using a value of 7, for reasons given in the earlier part of this section. See [mls qos queue-set drop-probability command on page 53.39](#).

Table 52-9: Drop Probability Table

Drop Value	0	1	2	3	4	5	6	7
Drop Probability	100%	50%	25%	12.5%	6.25%	3.12%	1.56%	0.78%

- For each queue-set, select suitable values for Min_{th} for each of the classes Red, Yellow, and Green for each queue within the set. We suggest that you start by setting each Min_{th} to be approximately half the value of the Max_{th} setting that you have already set for that particular color. See the [mls qos queue-set threshold command on page 53.41](#).
- Select a value for the Queue Length Averaging Factor. We suggest you initially use the default value of 9. See the [mls qos queue-set averaging-factor command on page 53.38](#).

Egress Queue Mapping

On the switch you can use the [match inner-vlan command on page 53.13](#) to select frames of a particular type. You can then assign these frames with a particular User Priority value then map them to one of eight egress queues. This facility enables you to accept frames that are already carrying meaningful priority information to be automatically assigned to an appropriate egress queue. For example, you could decide to send frames with a User Priority value of 7 to queue 3, and frames with a User Priority value of 2 to queue 7.

Frames entering a port at layer two may be tagged or untagged. VLAN tagged frames contain 3 additional fields as shown in [Figure 52-13](#) below. The User Priority field enables you to map incoming frames to any one of eight egress queues. This facility enables you can accept frames that are already carrying meaningful priority information to be automatically assigned to an appropriate egress queue. For example, you could decide to send frames with a User Priority value of 7 to queue 3, and frames with a User Priority value of 2 to queue 7.

Figure 52-13: User Priority Field

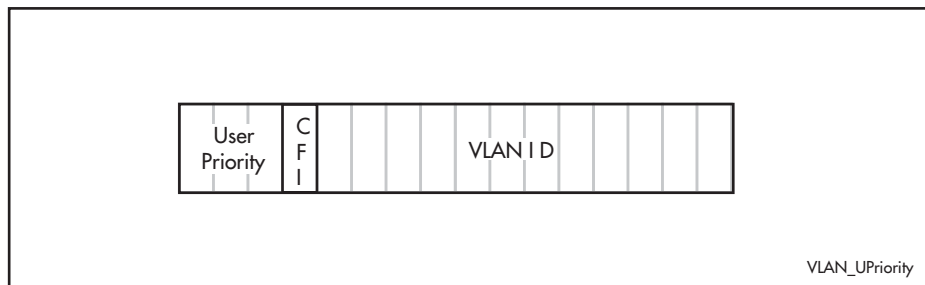

Mapping an Untagged frame to an Egress Queue

Frames entering a port with no VLAN tag and hence no User Priority Field, can be mapped to one of the eight Egress queue by using the [mls qos queue command on page 53.36](#). For example, you could decide to send all untagged frames to a low priority egress queue such as queue 7.

Mapping an IEEE 802.1P value to an Egress Queue

Immediately after ingress, a VLAN-tagged Ethernet frame can be assigned to an appropriate egress queue, based on the priority value that is set within the frame's VLAN Tag Information Field (TIF). To create the mapping between the TIF and a ports egress queue see the [mls qos map cos-queue to command on page 53.28](#).

Storm Protection

Storm protection uses QoS mechanisms to classify on traffic likely to cause a packet storm (broadcast and multicast). Unless you are running an enhanced storm protection feature such as Loop Protection, the per-port storm protection mechanism simply discards any traffic over the configured limit. However, with QoS storm protection, several actions are possible when a storm is detected:

- You can disable the port physically.
- You can disable the port logically.
- You can disable the port for a particular VLAN.

Before you can configure storm protection, you must first enable enhanced mode by using the [platform enhancedmode command on page 15.22](#). Storm protection is activated on a port after port state decisions have been made, and the port is in the STP forwarding state to forward frames and learn addresses.

When a storm is detected on a port, a message is automatically recorded in the log, and you can configure an SNMP trap to signal that a port has been disabled. When a storm is detected on a trunk or port group, the entire trunk or port group is disabled.

The following table explains the basic concepts involved with storm protection.

Concept	Description
Window	The frequency at which traffic is measured to determine whether storm protection should be activated.
Rate	The amount of traffic per second that must be exceeded before the switch takes the configured action.
Action	What the switch does when it detects a storm on a port.
Timeout	The length of time the port remains disabled after a port has been disabled due to a packet storm.

To set the action to take when triggered by QoS Storm Protection (QSP), use the [storm-action command on page 53.70](#).

To set the time to re-enable the port once disabled by QSP, use the [storm-downtime command on page 53.71](#).

To enable the Policy Based Storm Protection QSP, use the [storm-protection command on page 53.72](#).

QoS and the Switching Fabric

Ports on the x900 series switches belong to one of four switch processor instances: two on the base board and one on each expansion module. Switch instances exchange packets over a switching fabric. The switching fabric recognizes the priorities assigned to each packet and performs QoS queuing.

The switching fabric is different from the switch processor instance in that the switching fabric has four queues, whereas each switch port in a switch processor instance has eight egress queues. These two types of queues must be mapped to each other.

To specify the mapping of the 8 switch processor port queues to the 4 fabric queues, use the command: [mls qos map fabric-queue command on page 53.29](#).

The integers *q0* to *q7* indicate the fabric queue that corresponds to an egress queue.

You can also configure the switching fabric to use different scheduling methods for each of the four fabric queues. This controls the way that fabric queues share the available bandwidth during congested times. See the [mls qos map fabric-queue command on page 53.29](#).

To display information about settings for the switching fabric, use the command: [mls qos map fabric-queue command on page 53.29](#).

Policy-Based Routing

Policy based routing provides a means to create multiple paths to the same destination. The specific path that any particular packet will take can be based on configurable network metrics such as priority, protocol, or VLAN membership. For example, policy based routing can implement policies to allow or deny paths based on the identity of user devices, application, or packet sizes.

Practical Example

The example shown makes use of policy based routing to achieve the following:

1. Ensure that traffic being sent between local VLANs is switched normally.
2. Selects a particular egress path for traffic destined for the wide area networks.

Configuration Overview

A large government building houses employees from three separate government departments: Health, Welfare, and Employment. Each department has its own local subnet, and an associated VLAN; these are:

- 10.10.0.0/16 Health, VLAN 10
- 10.20.0.0/16 Welfare, VLAN 20
- 10.30.0.0/16 Employment, VLAN 30

Enquiries to each department are fed through a common Allied Telesis switch. The switch has 3 uplink ports, each of which (for simplicity) will be in a different VLAN and each will supply a connection to its relevant government department and to the Internet via each departments particular ISP (Internet Service Provider). These are:

- Port 1.0.1 Health Uplink, VLAN 110
- Port 1.0.5 Welfare Uplink, VLAN 120
- Port 1.0.21 Employment Uplink, VLAN 130

This configuration is illustrated in [Figure 52-14](#):

Figure 52-14: Policy-Based Routing Example

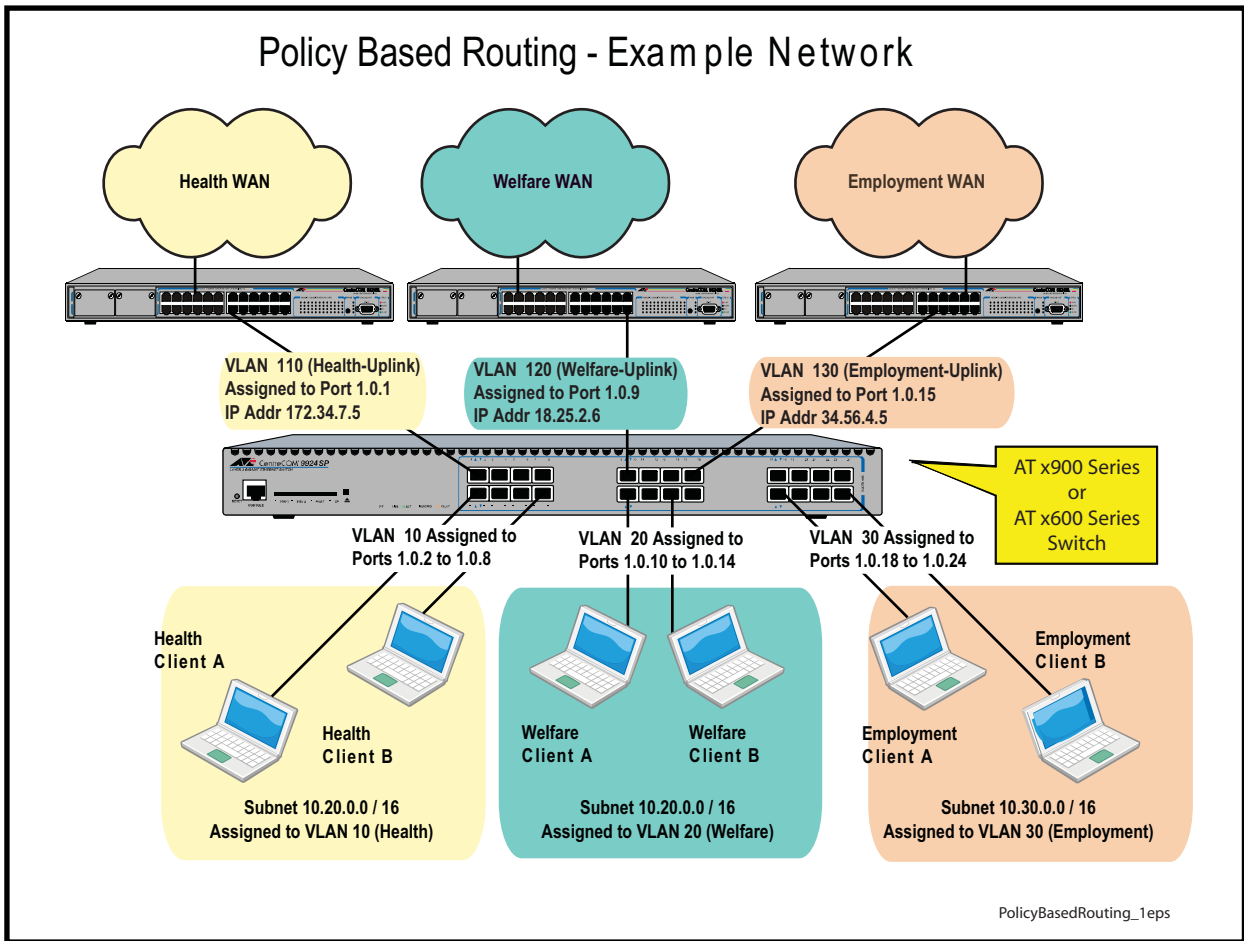

Configuration Steps

The following steps can be used to setup this example network. Since each step involves entering several instances of a command type, a single practical command entry is shown at the end of each step. The set of steps comprise the following:

1. Create VLANs on the switch.
2. Create access control lists (ACLs) that will match the data flows between local subnets.
3. Create ACLs that will match the data flows between local devices and other destinations.
4. Setup class-maps for each department and apply an access-list to each of the class maps.
5. Setup class-maps for each department's wide area connection and apply an access-list to each of these class maps.
6. Create the departmental policy-maps and associate them with their appropriate class-maps.
7. Apply these policy-maps to their appropriate ports.

These class-maps and ACLs are shown diagrammatically in [Figure 52-15](#) below.

Figure 52-15: Policy Based Routing Example - ClassMaps and ACLs

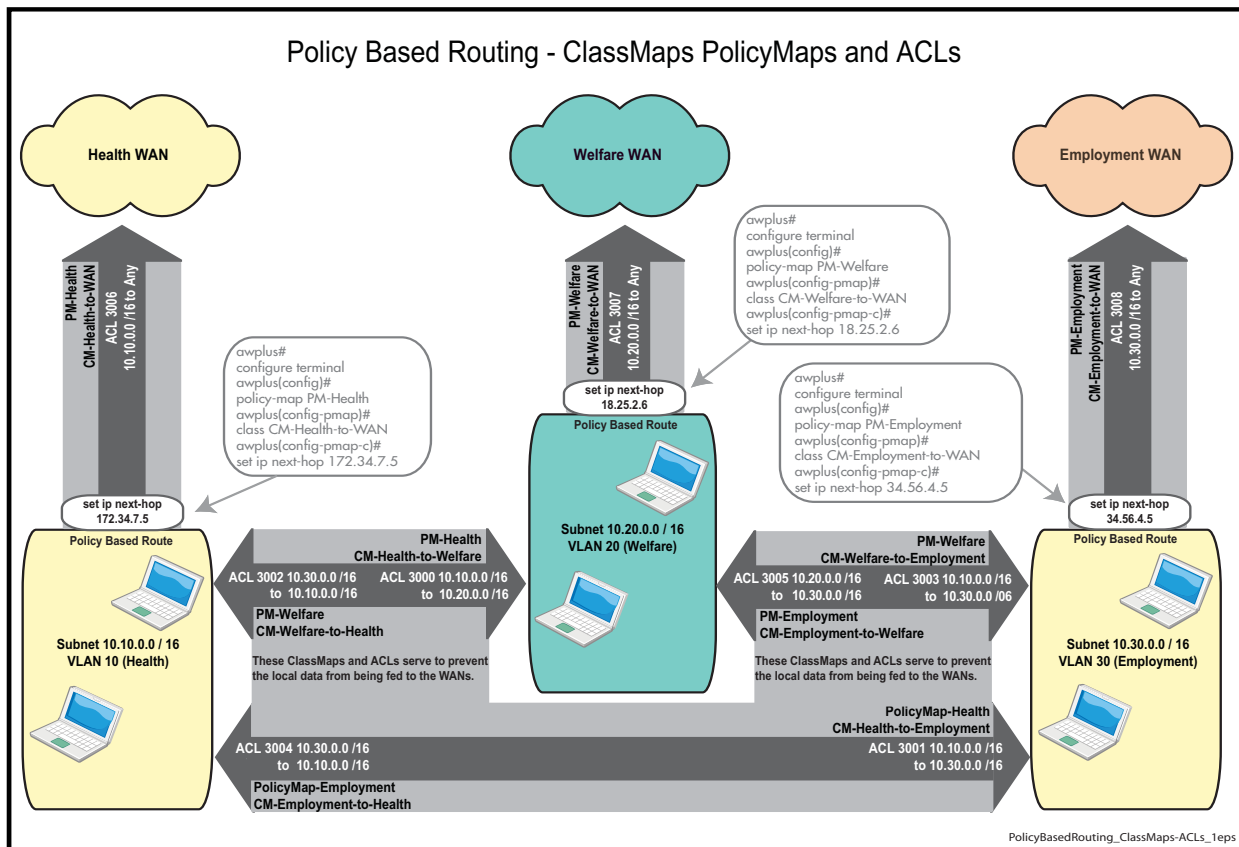

Step 1: Create VLANs on the switch

- Create VLANs 10, 20, and 30
- Apply these VLANs to their appropriate local ports

Practical example: Create VLAN 10 and apply it to ports 1.0.2 to 1.0.8 .

```

awplus# configure terminal

awplus(config)# interface port port1.0.2-port1.0.8

awplus(config)# switchport mode access

awplus(config)# switchport access vlan 10

```

- Create VLANs 110, 120, and 130
- Apply these VLANs to their appropriate WAN ports

Practical example: Create VLAN 110 and apply it to port 1.0.1.

```

awplus# configure terminal

awplus(config)# interface port port1.0.1

awplus(config)# switchport mode access

awplus(config)# switchport access vlan 110

```

Step 2: Create access control lists (ACLs) that will match the data flows between local user devices.

- `access-list 3000 permit ip 10.10.0.0/16 10.20.0.0/16`
Matches for packets from the Health user devices to Welfare user devices.
- `access-list 3001 permit ip 10.10.0.0/16 10.30.0.0/16`
Matches packets from the Health user devices to Employment user devices.
- `access-list 3002 permit ip 10.20.0.0/16 10.10.0.0/16`
Matches packets from the Welfare user devices to Health user devices.
- `access-list 3003 permit ip 10.20.0.0/16 10.30.0.0/16`
Matches packets from the Welfare user devices to Employment user devices.
- `access-list 3004 permit ip 10.30.0.0/16 10.10.0.0/16`
Matches packets from the Employment user devices to Health user devices.
- `access-list 3005 permit ip 10.30.0.0/16 10.20.0.0/16`
Matches packets from the Employment user devices to Welfare user devices.

Practical example: Create an ACL that matches packets from the Health user devices to Welfare user devices.

```
awplus# configure terminal
awplus(config)# access-list 3000 permit ip 10.10.0.0/16
10.20.0.0/16
```

Step 3: Create access control lists (ACLs) that will match the data flows between user devices and all other destinations.

- `access-list 3006 permit ip 10.10.0.0/16 any`
Matches packets from Health user devices to all other destinations.
- `access-list 3007 permit ip 10.20.0.0/16 any`
Matches packets from Welfare user devices all other destinations.
- `access-list 3008 permit ip 10.30.0.0/16 any`
Matches packets from Employment user devices to all other destinations.

Practical example: Matches packets from the Health user devices to all other destinations.

```
awplus# configure terminal
awplus(config)# access-list 3006 permit ip 10.10.0.0/16 any
```

Step 4: Setup class-maps for each department and apply an access-list to each of the class maps.

- `class-map CM-Health-to-Welfare`
Creates a class map called **CM-Health-to-Welfare**
- `match access-group 3000`
Applies the access-list 3000 to the **CM-Health-to-Welfare** class-map, so that this class-map applies to all packets matching this ACL.
- `class-map CM-Health-to-Employment`
Creates a class map called **CM-Health-to-Employment**.
- `match access-group 3001`
Applies the access-list 3001 to the **CM-Health-to-Employment** class-map, so that this class-map applies to all packets matching this ACL.
- `class-map CM-Welfare-to-Health`
Creates a class map called **CM-Welfare-to-Health**.
- `match access-group 3002`
Applies the access-list 3002 to the **CM-Welfare-to-Health** class-map, so that this class-map applies to all packets matching this ACL.
- `class-map CM-Welfare-to-Employment`
Creates a class map called **CM-Welfare-to-Employment**.
- `match access-group 3003`
Applies the access-list 3003 to the **CM-Welfare-to-Employment** class-map, so that this class-map applies to all packets matching this ACL.
- `class-map CM-Employment-to-Health`
Creates a class map called **CM-Employment-to-Health**.
- `match access-group 3004`
Applies the access-list 3004 to the **CM-Employment-to-Health** class-map, so that this class-map applies to all packets matching this ACL.
- `class-map CM-Employment-to-Health`
Creates a class map called **CM-Employment-to-Health**.
- `match access-group 3005`
Applies the access-list 3005 to the class-map **CM-Employment-to-Health** class-map, so that this class-map applies to all packets matching this ACL.

Practical example: Create the class-map Health-to-Welfare, then apply access list 3000 to it.

```
awplus# configure terminal
awplus(config)# class-map Health-to-Welfare
awplus(config-cmap)# match access-group 3000
```

Step 5: Setup class-maps for each department's wide area connection and apply an access-list to each of these class maps.

- `class-map CM-Health-to-WAN`
Creates a class map called CM-Health-to-WAN.
- `match access-group 3006`
Applies the access-list 3006 to the **CM-Health-to-WAN** class-map, so that this class-map applies to all packets matching this ACL.
- `class-map CM-Welfare-to-WAN`
Creates a class map called Welfare-to-WAN
- `match access-group 3007`
Applies the access-list 3007 to the **CM-Welfare-to-WAN** class-map, so that this class-map applies to all packets matching this ACL.
- `class-map CM-Employment-to-WAN`
Creates a class map called Employment-to-WAN.
- `match access-group 3008`
Applies the access-list 3008 to the **CM-Employment-to-WAN** class-map, so that this class-map applies to all packets matching this ACL.

Practical example: Create the class-map Health-to-Welfare, then apply access list 3006 to it.

```
awplus# configure terminal
awplus(config)# class-map CM-Health-to-WAN
awplus(config-cmap)# match access-group 3006
```

Step 6: Create the Departmental Policy-Maps and associate them with their appropriate Class-Maps.

- `policy-map PM-Health`
Creates the policy-map called PM-Health
- `class CM-Health-to-Welfare`
- `class CM-Health-to-Education`
Attaches the local Health class-maps to the PM-Health policy-map. Note that no action is applied to these two class maps. Packets that match either of these two class-maps will be forwarded across the local network using normal routing / forwarding procedures.
- `class CM-Health-to-WAN`
- `set ip next-hop 172.34.7.5`
Attaches the CM-Health-to-WAN class-map to this policy-map, and gives it a policy-routing action.
- `policy-map PM-Welfare`
Creates the policy-map called PM-Welfare
- `class CM-Welfare-to-Health`
- `class CM-Welfare-to-Employment`
Attaches the local Welfare class-maps to the PM-Welfare policy-map. Note that no action is applied to these two class maps. Packets that match either of these two class-maps will be forwarded across the local network using normal routing / forwarding procedures.
- `class CM-Welfare-to-WAN`

- `set ip next-hop 18.25.2.6`
Attaches the Welfare-to-WAN class-map to this policy-map, and gives it a policy-routing action.
- `policy-map PM-Employment`
Creates the policy-map called PM- Employment
- `class CM-Employment-to-Health`
- `class CM-Employment-to-Welfare`
Attaches the local Employment class-maps to the PM-Employment policy-map. Note that no action is applied to these two class maps. Packets that match either of these two class-maps will be forwarded across the local network using normal routing / forwarding procedures.
- `class CM-Employment-to-WAN`
- `set ip next-hop 34.56.4.5`
Attaches the Employment-to-WAN class-map to this policy-map, and gives it a policy-routing action.

Practical example: Create the policy-map called PM-Employment and attach its appropriate classmaps.

```

awplus# configure terminal
awplus(config)# policy-map PM-Employment
awplus(config-pmap)# class CM-Employment-to-Health
awplus(config-pmap-c)# exit
awplus(config-pmap)# class CM-Employment-to-Welfare
awplus(config-pmap-c)# exit
awplus(config-pmap)# class CM-Employment-to-WAN
awplus(config-pmap-c)# set ip next-hop 34.56.4.5

```

Step 7: Apply these Policy Maps to appropriate ports.

- `service-policy input Health-to-WAN`
- `service-policy input Welfare-to-WAN`
- `service-policy input Employment-to-WAN`

Practical example: To apply a policy map named pm-employment to port 1.0.15:

```

awplus# configure terminal
awplus(config)# interface port1.0.15
awplus(config-if)# service-policy input pm-employment

```

Chapter 53: QoS Commands



Command List	53.3
class	53.3
class-map	53.4
clear mls qos interface policer-counters	53.4
default-action	53.5
description (QoS policy map)	53.6
egress-rate-limit	53.7
match access-group	53.8
match cos	53.9
match dscp	53.10
match inner-cos	53.11
match inner-tpid	53.12
match inner-vlan	53.13
match ip-precedence	53.14
match mac-type	53.15
match protocol	53.16
match tcp-flags	53.19
match tpid	53.20
match vlan	53.21
mls qos aggregate-police action	53.22
mls qos cos	53.24
mls qos enable	53.25
mls qos fabric-queue	53.26
mls qos map cos-queue to	53.28
mls qos map fabric-queue	53.29
mls qos map policed-dscp to	53.31
mls qos map premark-dscp to	53.33
mls qos queue	53.36
mls qos queue-set	53.37
mls qos queue-set averaging-factor	53.38
mls qos queue-set drop-probability	53.39
mls qos queue-set description	53.40
mls qos queue-set threshold	53.41
no police	53.42
police aggregate	53.43
police single-rate action	53.44
police twin-rate action drop-red	53.46
policy-map	53.48
priority-queue	53.48
service-policy input	53.49
set bandwidth-class	53.50
set cos	53.51
set dscp	53.52
set ip next-hop (PBR)	53.53
set queue	53.54
show class-map	53.55
show mls qos aggregate-policer	53.56

show mls qos fabric-queue.....	53.57
show mls qos interface	53.57
show mls qos interface policer-counters.....	53.59
show mls qos interface queue-counters.....	53.60
show mls qos interface storm-status	53.62
show mls qos maps cos-queue.....	53.63
show mls qos maps fabric-queue.....	53.64
show mls qos maps policed-dscp	53.65
show mls qos maps premark-dscp.....	53.66
show mls qos queue-set	53.66
show policy-map.....	53.69
storm-action	53.70
storm-downtime.....	53.71
storm-protection	53.72
storm-rate.....	53.73
storm-window.....	53.74
trust dscp.....	53.75
trust dscp (XEM-2XP).....	53.76
wrr-queue disable queues.....	53.77
wrr-queue egress-rate-limit queues.....	53.78
wrr-queue group weight queues.....	53.79
wrr-queue queue-limit.....	53.80

Command List

This chapter provides an alphabetical reference for Quality of Service commands. For more information, see [Chapter 52, Quality of Service \(QoS\)](#) and [Chapter 49, Access Control Lists Introduction](#).

class

Use this command to associate an existing class map to a policy or policy map (traffic classification), and to enter Policy Map Class Configuration mode to configure the class map.

Use the **no** variant of this command to delete an existing class-map.

For more information on class-maps and policy maps, see the following sections: "[Class Maps](#)" on page 52.7 and "[Policy Maps](#)" on page 52.10.

Note that if your class map does not exist, you can create it by using the [class-map](#) command.

Syntax `class {<name>|default}`
`no class <name>`

Parameter	Description
<name>	Name of the (already existing) class map.
default	Specify the default class map.

Mode Policy Map Class

Example The following example creates the policy map `pmap1` (using the `policy-map` command), then associates this to an already existing class map named `cmap1`.

```
awplus# configure terminal
awplus(config)# policy-map pmap1
awplus(config-pmap)# class cmap1
awplus(config-pmap-c)#
```

Related Commands [class-map](#)
[policy-map](#)

class-map

Use this command to create a class map.

Use the **no** variant of this command to delete the named class map.

Syntax `class-map <name>`
`no class-map <name>`

Parameter	Description
<code><name></code>	Name of the class map to be created.

Mode Global Configuration

Example This example creates a class-map called `cmap1`:

```
awplus# configure terminal
awplus(config)# class-map cmap1
awplus(config-cmap)#
```

clear mls qos interface policer-counters

Resets an interface's policer counters to zero. This can either be for a specific class-map or for all class-maps.

Before running this command you must first enable the QoS counter platform enhanced mode.

Syntax `clear mls qos interface <port> policer-counters`
`[class-map <class-map>]`

Parameter	Description
<code><port></code>	The port may be a switch port (e.g. <code>port1.1.4</code>), a static channel group (e.g. <code>sa3</code>), or a dynamic (LACP) channel group (e.g. <code>po4</code>).
<code>class-map</code>	Select a class-map.
<code><class-map></code>	Class-map name.

Mode Privileged Exec

Example To reset the policy counters to zero for all class maps for `port1.0.1`:

```
awplus# clear mls qos interface port1.0.1 policer-counters
```

Related Commands [platform enhancedmode](#)
[show mls qos interface policer-counters](#)

default-action

Sets the action for the default class-map belonging to a particular policy-map. The action for a non-default class-map depends on the action of any ACL that is applied to the policy-map.

The default action can therefore be thought of as specifying the action that will be applied to any data that does not meet the criteria specified by the applied matching commands.

Use the **no** variant of this command to reset to the default action of 'permit'.

Syntax `default-action [permit|deny|send-to-cpu|copy-to-cpu|copy-to-mirror|send-to-mirror]`

`no default-action`

Parameter	Description
<code>permit</code>	Packets to permit.
<code>deny</code>	Packets to deny.
<code>send-to-cpu</code>	Specify packets to send to the CPU.
<code>copy-to-cpu</code>	Specify packets to copy to the CPU.
<code>copy-to-mirror</code>	Specify packets to copy to the mirror port.
<code>send-to-mirror</code>	Specify packets to send to the mirror port.

Default The default is 'permit'.

Mode Policy Map

Example To set the action for the default class-map to deny

```
awplus(config-pmap)# default-action deny
```

description (QOS policy map)

Adds a textual description of the policy-map. This can be up to 80 characters long.

Use the **no** variant of this command to remove the current description from the policy-map.

Syntax `description <line>`

`no description`

Parameter	Description
<code><line></code>	Up to 80 character long line description.

Mode Policy Map

Example To add the description, VOIP traffic:

```
awplus(config-pmap)# description VOIP traffic
```

egress-rate-limit

Sets a limit on the amount of traffic that can be transmitted per second from this port. The default unit is in Kb, but Mb or Gb can also be specified. The minimum is 651 Kb.

Use the **no** variant of this command to disable the limiting of traffic egressing on the interface.

Syntax `egress-rate-limit <bandwidth>`
`no egress-rate-limit`

Parameter	Description
<code><bandwidth></code>	Bandwidth <1-10000000 kbits per second> (usable units: k, m, g).

Mode Interface Configuration

Usage Note that the command syntax is not case sensitive, so a value such as 20 mb will be taken to mean 20 mega bits.

Examples To enable egress rate limiting on a port enter the commands:

```
awplus# configure terminal
awplus(config)# interface port1.0.1
awplus(config-if)# egress-rate-limit 500m
% Egress rate limit has been set to 500 Mb
```

To disable egress rate limiting on a port enter the commands:

```
awplus# configure terminal
awplus(config)# interface port1.0.1
awplus(config-if)# no egress-rate-limit
```

match access-group

Use this command to define match criterion for a class map.

Syntax `match access-group <group-number>`
`no match access-group <group-number>`

Parameter	Description
<code><group-number></code>	The access-group number (this will have the same number as the access list it is applying). The number selected can be any between the following ranges: 3000 to 3699 and 4000 to 4699.

Mode Global Configuration

Usage First create an access list that applies the appropriate permit, deny requirements etc. Then use the **match access-group** command to apply this access list for matching to a class map. Note that this command will apply the access list matching only to *incoming* data packets.

Example The following example configures a class map named `cmap1` with one match criterion: `access-list 3001`, which allows traffic from any source to any destination:

```
awplus# configure terminal
awplus(config)# access-list 3001 permit any any
awplus(config)# class-map cmap1
awplus(config-cmap)# match access-group 3001
```

Related Commands `class-map`

match cos

Sets the CoS for a class-map to match on.

Use the **no** variant of this command to remove CoS.

Syntax `match cos <0-7>`

`no match cos`

Parameter	Description
<code><0-7></code>	Specify the CoS value.

Mode Class Map

Examples To set the class-map's CoS to 4:

```
awplus# config terminal
awplus(config)# class-map cmap1
awplus(config-cmap)# match cos 4
```

To remove CoS from a class-map:

```
awplus# config terminal
awplus(config)# class-map cmap1
awplus(config-cmap)# no match cos
```

match dscp

Use this command to define the DSCP to match against incoming packets.

Use the **no** variant of this command to remove a previously defined DSCP.

Syntax `match dscp <0-63>`

`no match dscp`

Parameter	Description
<0-63>	Specify DSCP value (only one value can be selected).

Mode Class Map

Usage Use the **match dscp** command to define the match criterion after creating a class map.

Examples To configure a class map named `cmap1` with criterion that matches IP DSCP 56.

```
awplus# configure terminal
awplus(config)# class-map cmap1
awplus(config-cmap)# match dscp 56
```

To remove a previously defined DSCP from a class map named `cmap1`:

```
awplus# configure terminal
awplus(config)# class-map cmap1
awplus(config-cmap)# no match dscp
```

Related Commands `class-map`

match inner-cos

Sets the Inner CoS for a class-map to match on.

Use the **no** variant of this command to remove CoS.

Syntax `match inner-cos <0-7>`
`no match inner-cos`

Parameter	Description
<0-7>	Specify the Inner CoS value.

Mode Class Map

Examples To set the class-map's inner-cos to 4:

```
awplus# config terminal
awplus(config)# class-map cmap1
awplus(config-cmap)# match inner-cos 4
```

To remove CoS from the class_map:

```
awplus# config terminal
awplus(config)# class-map cmap1
awplus(config-cmap)# no match inner-cos
```

match inner-tpid

Sets the Inner Tag Protocol Identifier (TPID) for a class-map to match on.

Use the **no** variant of this command to remove the TPID for a class-map.

Syntax `match inner-tpid <tpid>`

`no match inner-tpid`

Parameter	Description
<code><tpid></code>	Two byte hexadecimal number representing the TPID.

Mode Class Map

Examples To set the class-map's inner-tpid to 0x9100:

```
awplus# config terminal
awplus(config)# class-map cmap1
awplus(config-cmap)# match inner-tpid 0x9100
```

To remove the class-map's inner-tpid:

```
awplus# config terminal
awplus(config)# class-map cmap1
awplus(config-cmap)# no match inner-tpid
```

match inner-vlan

Use this command to define the inner VLAN ID used as match criteria to classify a traffic class.

Use the **no** variant of this command to disable the VLAN ID used as match criteria.

Syntax `match inner-vlan <1-4094>`

`no match inner-vlan`

Parameter	Description
<code><1-4094></code>	The VLAN number.

Mode Class Map

Usage This command is used in double-tagged networks to match on a VLAN ID belonging to the client network. For more information on VLAN double-tagged networks, see [“VLAN Double Tagging \(VLAN Stacking\)” on page 16.5](#).

Examples To configure a class-map named `cmap1` to include traffic from inner VLAN 3:

```
awplus# config terminal
awplus(config)# class-map cmap1
awplus(config-cmap)# match inner-vlan 3
```

To disable the configured VLAN ID as a match criteria for the class-map named `cmap1`:

```
awplus# config terminal
awplus(config)# class-map cmap1
awplus(config-cmap)# no match inner-vlan
```

match ip-precedence

Use this command to identify IP precedence values as match criteria.

Use the **no** variant of this command to remove IP precedence values from a class map.

Syntax `match ip-precedence <0-7>`
`no match ip-precedence`

Parameter	Description
<0-7>	The precedence value to be matched.

Mode Class Map

Example To configure a class-map named `cmap1` to evaluate all IPv4 packets for a precedence value of 5:

```
awplus# configure terminal
awplus(config)# class-map cmap1
awplus(config-cmap)# match ip-precedence 5
```

match mac-type

Use this command to set the mac type for a class-map to match on.

Use **no** variant of this command to remove mac type.

Syntax `match mac-type {l2bcast|l2mcast|l2ucast}`

`no match mac-type`

Parameter	Description
l2bcast	Layer 2 Broadcast.
l2mcast	Layer 2 Multicast.
l2ucast	Layer 2 Unicast.

Mode Class Map

Examples To set the class-map's MAC type to layer 2 broadcast:

```
awplus# config terminal
awplus(config)# class-map cmap1
awplus(config-cmap)# match mac-type l2bcast
```

To remove the class-map's MAC type:

```
awplus# config terminal
awplus(config)# class-map cmap1
awplus(config-cmap)# no match mac-type
```

match protocol

Sets the ethernet format and protocol for a class-map to match on. Select one layer two eth-format "and" one layer three protocol.

Use the **no** variant of this command to remove ethernet format and protocol from a class-map.

Syntax `match eth-format {<layer-two-format>} protocol {<layer-three-protocol>}`

`no match eth-format protocol`

Parameter	Description
<i><layer-two-formats></i>	
802dot2-tagged	802.2 Tagged Packets (enter the parameter name)
802dot2-untagged	802.2 Untagged Packets (enter the parameter name)
ethii-tagged	EthII Tagged Packets (enter the parameter name)
ethii-untagged	EthII Untagged Packets (enter the parameter name)
netwareraw-tagged	Netware Raw Tagged Packets (enter the parameter name)
netwareraw-untagged	Netware Raw Untagged Packets (enter the parameter name)
snap-tagged	SNAP Tagged Packets (enter the parameter name)
snap-untagged	SNAP Untagged Packets (enter the parameter name)
<i><layer-three-protocols></i>	
<word>	A Valid Protocol Number in hexadecimal
any	Any protocol
sna-path-control	Protocol Number 04 (enter the parameter name or its number)
proway-lan	Protocol Number 0E (enter the parameter name or its number)
eia-rs Protocol	Number 4E (enter the parameter name or its number)
proway Protocol	Number 8E (enter the parameter name or its number)
ipx-802dot2	Protocol Number E0 (enter the parameter name or its number)
netbeui	Protocol Number F0 (enter the parameter name or its number)
iso-clns-is	Protocol Number FE (enter the parameter name or its number)
xdot75-internet	Protocol Number 0801(enter the parameter name or its number)

Parameter (cont.)	Description (cont.)
nbs-internet	Protocol Number 0802 (enter the parameter name or its number)
ecma-internet	Protocol Number 0803 (enter the parameter name or its number)
chaosnet	Protocol Number 0804 (enter the parameter name or its number)
xdot25-level-3	Protocol Number 0805 (enter the parameter name or its number)
arp Protocol	Number 0806 (enter the parameter name or its number)
xns-compat	Protocol Number 0807 (enter the parameter name or its number)
banyan-systems	Protocol Number 0BAD (enter the parameter name or its number)
bbn-simnet	Protocol Number 5208 (enter the parameter name or its number)
dec-mop-dump-ld	Protocol Number 6001 (enter the parameter name or its number)
dec-mop-rem-cdots	Protocol Number 6002 (enter the parameter name or its number)
dec-decnet	Protocol Number 6003 (enter the parameter name or its number)
dec-lat	Protocol Number 6004 (enter the parameter name or its number)
dec-diagnostic	Protocol Number 6005 (enter the parameter name or its number)
dec-customer	Protocol Number 6006 (enter the parameter name or its number)
dec-lavc	Protocol Number 6007 (enter the parameter name or its number)
rarp	Protocol Number 8035 (enter the parameter name or its number)
dec-lanbridge	Protocol Number 8038 (enter the parameter name or its number)
dec-encryption	Protocol Number 803D (enter the parameter name or its number)
appletalk	Protocol Number 809B (enter the parameter name or its number)
ibm-sna	Protocol Number 80D5 (enter the parameter name or its number)
appletalk-aarp	Protocol Number 80F3 (enter the parameter name or its number)

Parameter (cont.)	Description (cont.)
snmp	Protocol Number 814Cv
ethertalk-2	Protocol Number 809B (enter the parameter name or its number)
ethertalk-2-aarp	Protocol Number 80F3 (enter the parameter name or its number)
ipx-snap	Protocol Number 8137 (enter the parameter name or its number)
ipx-802dot3	Protocol Number FFFF (enter the parameter name or its number)
ip	Protocol Number 0800 (enter the parameter name or its number)
ipx	Protocol Number 8137 (enter the parameter name or its number)
ipv6	Protocol Number 86DD (enter the parameter name or its number)

Mode Class Map

Examples To remove the eth-format and protocol from the class-map:

```
awplus# config terminal
awplus(config)# class-map cmap1
awplus(config-cmap)# no match eth-format protocol
```

The following command sets the class-map's eth-format to ethii-tagged and protocol to 0800 (IP).

```
awplus# config terminal
awplus(config)# class-map
awplus(config-cmap)# match eth-format ethii-tagged protocol
0800
or
awplus(config-cmap)# match eth-format ethii-tagged protocol ip
```

match tcp-flags

Sets one or more tcp flags (control bits) for a class-map to match on.

Use the **no** variant of this command to remove one or more tcp flags for a class-map to match on.

Syntax `match tcp-flags {[ack][fin][rst][syn][urg]}`
`no match tcp-flags {[ack][fin][rst][syn][urg]}`

Parameter	Description
ack	Acknowledge
fin	Finish
rst	Reset
syn	Synchronize
urg	Urgent

Mode Class Map

Examples To set the class-map's tcp flags to ack and syn:

```
awplus# config terminal
awplus(config)# class-map
awplus(config-cmap)# match tcp-flags ack syn
```

To remove the tcp-flags ack and rst:

```
awplus# config terminal
awplus(config)# class-map
awplus(config-cmap)# no match tcp-flags ack rst
```

match tpid

Sets the Tag Protocol Identifier (TPID) for a class map to match on.

Use the **no** variant of this command to remove the TPID for a class-map.

Syntax `match tpid <tpid>`

`no match tpid`

Parameter	Description
<code><tpid></code>	Specify the Tag Protocol Identifier.

Mode Class Map

Examples To set the TPID of class map named `cmap1` to `0x9100`:

```
awplus# configure terminal
awplus(config)# class-map cmap1
awplus(config-cmap)# match tpid 0x9100
```

To remove the TPID set previously for class map named `cmap1`:

```
awplus# configure terminal
awplus(config)# class-map cmap1
awplus(config-cmap)# no match tpid
```

match vlan

Use this command to define the VLAN ID used as match criteria to classify a traffic class.

Use the **no** variant of this command to disable the VLAN ID used as match criteria.

Syntax `match vlan <1-4094>`

`no match vlan`

Parameter	Description
<code><1-4094></code>	The VLAN number.

Mode Class Map Mode

Examples To configure a class-map named `cmap1` to include traffic from VLAN 3:

```
awplus# config terminal
awplus(config)# class-map cmap1
awplus(config-cmap)# match vlan 3
```

To disable the configured VLAN ID as a match criteria for the class-map named `cmap1`:

```
awplus# config terminal
awplus(config)# class-map cmap1
awplus(config-cmap)# no match vlan
```

mls qos aggregate-police action

This command creates or reconfigures an aggregate policer for a class-map.

The **no** variant of this command removes a previously configured exceed action.

Syntax For single rate metering:

```
mls qos aggregate-police <name> single-rate <CIR> <CBS> <EBS>
  action [drop-red|policed-dscp-transmit]
```

For twin rate metering:

```
mls qos aggregate-police <name> twin-rate <CIR> <CBS> <EIR> <PBS>
  action [drop-red|policed-dscp-transmit]
```

```
no mls qos aggregate-police <name>
```

Parameter	Description
<name>	Specify aggregate-policer name
single-rate	Single rate meter (one rate and two burst sizes)
twin-rate	Twin rate meter (two rates and two burst sizes)
<CIR>	The Committed Information Rate. Specify an average traffic rate, 1-16000000 (kbps)
<CBS>	The amount by which the data is allowed to burst beyond the value set by the CIR. Specify a value from 0-16777216 (bytes)
<EIR>	Excess Information Rate. Specify an average traffic rate, 1-16000000 (kbps)
<EBS>	<i>For single-rate metering</i> , this is the amount by which the data is allowed to burst beyond the value set by the CIR.
<PBS>	<i>For twin-rate metering</i> , this is the amount by which the data is allowed to burst beyond the value set by the EIR. Specify a value from 1-16777216 (bytes)
action	Specify the action: either drop-red or policed-dscp-transmit
drop-red	Drop the red packets
policed-dscp-transmit	Change packet per policed-dscp map and send it

Mode Policy Map Class

Usage A policer can be used to meter the traffic classified by the class-map and as a result will be given one of three bandwidth classes. These are green (conforming), yellow (partially-conforming), and red (non-conforming).

Once you have created an aggregate policer, you can use the [police aggregate command on page 53.43](#) to assign it to one or more class-maps. This enables traffic classified by different characteristics to have accumulative application to the same policer. Another application of aggregate policers is to attach them to a single class-map but apply the class-maps to multiple ports (via its policy-map). This enables the same traffic to have accumulative policed application over multiple ports.

A single-rate policer is based on three values. These are:

- average rate (or Committed Information Rate CIR)
- minimum burst (or Committed Burst Size CBS)
- maximum burst (or Excess Burst Size EBS)

Traffic is classed as green if the rate is less than the combined CIR plus CBS values. Traffic is classed as yellow if the data rate is between the CBS and the EBS. Traffic is classed as red if the rate exceeds the average rate and the EBS.

A dual-rate policer is based on four values. These are:

- average rate (or Committed Information Rate CIR)
- minimum burst (or Committed Burst Size CBS)
- maximum burst (or Excess Burst Size EBS)
- Excess Information Rate (EIR)

Traffic is classed as green if the rate is less than the CIR and CBS. Traffic is classed as yellow if the rate is between the CBS and the EBS. Traffic is classed as red if the rate exceeds the average rate and the EBS.

Using an action of **drop-red** will result in all packets classed as red being discarded.

When using an action of **policed-dscp-transmit** the packet will be remarked with the values configured in the policed-dscp map. The index into this map is determined by the DSCP in the packet. If a DSCP index is to be forced regardless of the packet DSCP the [set dscp](#) command can be used to achieve this. If no DSCP is present in the packet an index of 0 will be used.

Example This example shows a single rate meter measuring traffic of 10 Mbps that drops any traffic bursting over 30000 bytes:

```
awplus# config terminal
awplus(config)# policy-map name
awplus(config-pmap)# class classname
awplus(config-pmap-c)# mls qos aggregate-police ap1 single-rate
10000 20000 30000 action drop-red
```

Related Commands [mls qos map policed-dscp to police aggregate](#)
[show mls qos aggregate-policer](#)
[show mls qos maps policed-dscp](#)

mls qos cos

This command assigns a CoS (Class of Service) user-priority value to untagged frames entering a specified interface. By default, all untagged frames are assigned a CoS value of 0.

Use the **no** variant of this command to return the interface to the default CoS setting for untagged frames entering the interface.

Syntax `mls qos cos <0-7>`
`no mls qos cos`

Parameter	Description
<0-7>	The Class of Service, user-priority value.

Default By default, all untagged frames are assigned a CoS value of 0. Note that for tagged frames, the default behavior is not to alter the CoS value.

Mode Interface

Example To assign a CoS user priority value of 3 to all untagged packets entering ports 1.0.1 to 1.0.20, use the commands:

```
awplus# config terminal
awplus(config)# interface port1.0.1-port1.0.20
awplus(config-if)# mls qos cos 3
```

mls qos enable

Use this command to globally enable QoS on the switch or stack.

Use the **no** variant of this command to globally disable QoS and remove all QoS configuration. The **no** variant of this command removes all class-maps policy-maps policers queue-sets that have been created. Running the **no mls qos** command will therefore remove all pre-existing QoS configurations on the switch.

Mode Global Configuration

Syntax `mls qos enable`

`no mls qos`

Example To enable QoS on the switch:

```
awplus# config terminal
awplus(config)# mls qos enable
```

mls qos fabric-queue

Configures the scheduling algorithm for one or more fabric queues. If the scheduler is weighted round robin (WRR), a weighting can also be specified. You must specify at least one queue when setting this command.

The **no** variant of this command resets the scheduling algorithm for one or more input fabric queues. Default is priority.

Syntax `mls qos fabric-queue {[0][1][2][3]}{priority|wrr [weight <1-30>]}`
`no mls qos fabric-queue [0][1][2][3]`

Parameter	Description
0, 1, 2, 3	fabric queues being configured.
priority	Applies strict priority queue servicing to the selected queues.
wrr	Applies weighted round robin queue servicing to the selected queues.
weight	The weight for weighted round robin selection. Queues will then be serviced in proportion to their applied weights. Default is 1.
<1-30>	The weight value.

Mode Global Configuration

Usage Queues can be serviced in either priority sequence or a weighted round-robin sequence. By default all queues are set to priority servicing.

Priority Sequencing

In this mode the queue with the highest number, i.e. queue 3 will be emptied first, then queues 2, 1 and 0. Note that the lower queues will only be serviced if there is no data waiting in the higher numbered queues.

Weighted Round Robin Sequencing

In this mode the weighting that you assign to each queue will determine how often it is serviced with respect to the other WRR queues. For example, if queue 0 is configured with a weight of 5 and queue 1 is configured with a weight of 1, then queue 0 will be serviced 5 times more than queue 1. Setting all weights to the same value will therefore apply an unweighted round selection method.

Mixed Sequencing

If you configure the queues with a mix of priority queueing and WRR, the priority queues will be completely emptied, before the any WRR queue is serviced.

Examples To set the scheduler for fabric queues 0 and 1 to WRR and both have a weight of 5 use the command:

```
awplus# config terminal
awplus(config)# mls qos fabric-queue 0 1 wrr weight 5
```

To reset the scheduling algorithm for fabric-queues 0 and 1, use the command:

```
awplus# config terminal
awplus(config)# no mls qos fabric-queue 0 1
```

Related Commands `mls qos map fabric-queue`
`show mls qos fabric-queue`
`show mls qos maps fabric-queue`

mls qos map cos-queue to

Used to set the default CoS to queue mapping. This is the default queue mapping for packets that do not get assigned a queue via any other QoS functionality.

Use the **no** variant of this command to reset the cos-queue map back to its default setting. The default mappings for this command are:

CoS Priority :	0	1	2	3	4	5	6	7

CoS QUEUE:	2	0	1	3	4	5	6	7

For more information see, “Mapping CoS tags to traffic types” on page 52.13.

Syntax `mls qos map cos-queue <cos-priority> to <queue-number>`
`no mls qos map cos-queue`

Parameter	Description
<code><cos-priority></code>	CoS priority value. Can take a value 0 to 7.
<code><queue-number></code>	Queue number. Can take a value 0 to 7.

Mode Global Configuration

Examples To set the cos-queue map back to its defaults, use the command:

```
awplus# config terminal
awplus(config)# no mls qos map cos-queue
```

:To map CoS 2 to queue 3:

```
awplus# config terminal
awplus(config)# mls qos map cos-queue 2 to 3
```

Related Commands `mls qos map fabric-queue`
`show mls qos fabric-queue`
`show mls qos maps fabric-queue`
`mls qos queue-set averaging-factor`
`mls qos queue-set description`
`mls qos queue-set drop-probability`
`mls qos queue-set threshold`
`show mls qos interface`
`show mls qos queue-set`

mls qos map fabric-queue

This command maps eight egress queues to four fabric queues. Note that when entering this command, you must supply a mapping for all eight egress queues.

Use the **no** variant of this command to reset the fabric queue map. This table maps eight egress queues to four fabric-queues. The default maps egress queues 0 and 1 to fabric queue 0, egress queues 2 and 3 to fabric queues 1, egress queues 4 and 5 to fabric queue 2 and egress queues 6 and 7 to fabric queue 3.

Syntax `mls qos map fabric-queue q0 q1 q2 q3 q4 q5 q6 q7`
`no mls qos map fabric-queue`

Parameter	Description
q0	Egress queue 0 (Select a value 0 to 3 to map this egress queue to one of the four fabric queues q0-q4).
q1	Egress queue 1 (Select a value 0 to 3 to map this egress queue to one of the four fabric queues q0-q4).
q2	Egress queue 2 (Select a value 0 to 3 to map this egress queue the one of the four fabric queues q0-q4).
q3	Egress queue 3 (Select a value 0 to 3 to map this egress queue to one of the four fabric queues q0-q4).
q4	Egress queue 4 (Select a value 0 to 3 to map this egress queue to one of the four fabric queues q0-q4).
q5	Egress queue 5 (Select a value 0 to 3 to map this egress queue to one of the four fabric queues q0-q4).
q6	Egress queue 6 (elect a value 0 to 3 to map this egress queue to one of the four fabric queues q0-q4).
q7	Egress queue 7 (Select a value 0 to 3 to map this egress queue to one of the four fabric queues q0-q4).

Mode Global Configuration

Examples This example maps egress queue 7 to fabric queue 3, egress queue 6 to fabric queue 2, egress queue 5 to fabric queue 1, and the rest of the egress queues to fabric queue 0, as shown in [Figure 53-1 on page 53.30](#) use the command:

```
awplus# config terminal
awplus(config)# mls qos map fabric-queue 0 0 0 0 0 1 2 3
```

The following table shows how the queue mapping operates in the above example:

Egress Queue	0	1	2	3	4	5	6	7
Fabric Queue Mapping	0	0	0	0	0	1	2	3

Figure 53-1: Egress Queue to Fabric Queue mapping:

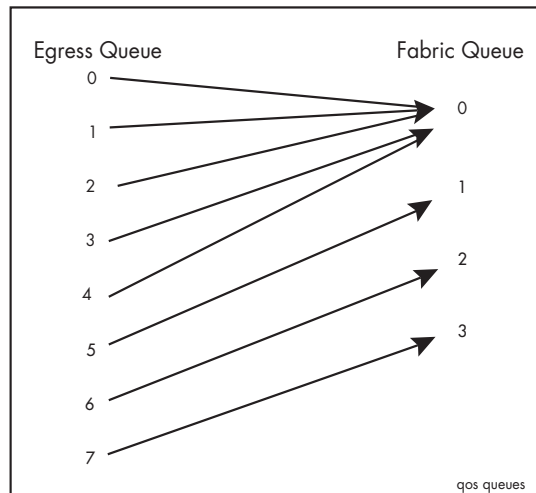

To reset the fabric-queue map, use the command:

```
awplus# config terminal  
awplus(config)# no mls qos map fabric-queue
```

Related Commands

- mls qos fabric-queue
- show mls qos fabric-queue
- show mls qos maps fabric-queue

mls qos map policed-dscp to

Configures the policed-dscp map. This is used when a policer is configured with an exceed action of 'policed-dscp-transmit'. Bandwidth-class is optional - if omitted, the changes will be applied to all bandwidth classes. At least one 'new' parameter must be specified.

Use the **no** variant of this command to reset the policed-dscp map to its default. This is used when a policer is configured with an exceed action of 'policed-dscp-transmit'. Specifying DSCP and bandwidth-class is optional. If no DSCP is specified then all DSCP entries will be reset to their defaults. If no bandwidth-class is specified then all bandwidth-class entries will be reset to their defaults.

Syntax

```
mls qos map policed-dscp <existing-dscp> [bandwidth-class {green|yellow|red}] to {[new-dscp <0-63>] [new-cos <0-7>] [new-queue <0-7>] [new-bandwidth-class {green|yellow|red}]}
no mls qos map policed-dscp [<new-dscp>] [bandwidth-class {green|yellow|red}]
```

Parameter	Description
<existing-dscp>	The value of the DSCP when it leaves the policer (meter) <0-63>.
bandwidth-class	Bandwidth Class.
green	Mark the packet as green.
yellow	Mark the packet as yellow.
red	Mark the packet as red.
to	Change the value to:
new-dscp	Modify Egress DSCP.
<0-63>	Egress DSCP value (marked down DSCP).
new-cos	Modify Egress CoS.
<0-7>	Egress CoS value (marked down CoS).
new-queue	Modify Egress Queue.
<0-7>	Egress Queue value (marked down Queue).
new-bandwidth-class	Modify Egress Bandwidth-class.
green	Egress Bandwidth-class green (marked down Bandwidth-class).
yellow	Egress Bandwidth-class yellow (marked down Bandwidth-class).
red	Egress Bandwidth-class red (marked down Bandwidth-class).
<new-dscp>	DSCP entry to reset.
bandwidth-class	bandwidth class to reset.
green	Green traffic.

Parameter (cont.)	Description (cont.)
yellow	Yellow traffic.
red	Red traffic.

Mode Global Configuration

Example To set the entry at DSCP 2 to remark the policed green traffic to a new DSCP of 2, a new CoS of 3, and new queue of 4 and a new bandwidth class of `yellow`, use the command:

```
awplus# config terminal
```

```
awplus(config)# mls qos map policed-dscp 2 bandwidth-class  
green to new-dscp 5 new-cos 3 new-queue 4 new-  
bandwidth-class yellow
```

Related Commands `mls qos map policed-dscp to`
`police single-rate action`
`police twin-rate action drop-red`
`show mls qos maps policed-dscp`

mls qos map premark-dscp to

The operation of this command varies by platform type. These platform types are:

- Generic platform - when applied to ports on the x900 chassis and non 2XP XEMs.
- XEM-2XP platform - when applied to ports on the XEM-2XP module.

Generic Platform

This command configures the premark-dscp map. It is used when traffic is classified by a class-map that has `trust dscp` configured. Based on a lookup DSCP, the map determines a new DSCP, COS, queue and bandwidth class for the traffic.

If the `set dscp` command has also been specified for that class-map, the set value is used for the lookup of the premark-dscp map. Otherwise the DSCP value in the packet is used for the lookup.

The `no` variant of this command resets the premark-dscp map to its defaults. If no DSCP is specified then all DSCP entries will be reset to their defaults.

Syntax

```
mls qos map premark-dscp <0-63> to {[new-dscp <0-63>]
    [new-cos <0-7>] [new-queue <0-7>] [new-bandwidth-class {green|
    yellow|red}]}
```

```
no mls qos map premark-dscp [<0-63>]
```

Parameter	Description
<code>premark-dscp <0-63></code>	The DSCP value on ingress.
<code>new-dscp <0-63></code>	The DSCP value that the packet will have on egress. If unspecified, this value will remain the DSCP ingress value.
<code>new-cos <0-7></code>	The CoS value that the packet will have on egress. If unspecified, this value will be set to zero.
<code>new-queue <0-7></code>	Modify Egress Queue.
<code>new-bandwidth-class</code>	Modify Egress Bandwidth-class. If unspecified, this value will be set to green.
<code>green</code>	Egress Bandwidth-class green (marked down Bandwidth-class).
<code>yellow</code>	Egress Bandwidth-class yellow (marked down Bandwidth-class).
<code>red</code>	Egress Bandwidth-class red (marked down Bandwidth-class).

Mode Global Configuration

Usage With the `"trust dscp"` on page 53.75 set, this command (`mls qos map premark-dscp`) enables you to remap any or all of the dscp, CoS, output queue, or bandwidth class values in one step, i.e. a single run of this command.

Example To set the entry for DSCP 1 to use a new DSCP of 2, a new CoS of 3, a new queue of 4 and a new bandwidth class of yellow, use the command:

```
awplus# config terminal
awplus(config)# mls qos map premark-dscp 1 to new-dscp 2 new-
cos 3 new-queue 4 new-bandwidth-class yellow
```

XEM-2XP Platform

Configures the premark-dscp map. This is used when traffic is classified by a policy-map that has [trust dscp](#) configured. Based on a lookup DSCP, the map determines a new DSCP, COS, queue and bandwidth class for the traffic. The DSCP value in the packet is used for the lookup.

The **no** variant of this command resets the premark-dscp map to its defaults. If no DSCP is specified then all DSCP entries will be reset to their defaults.

Syntax `mls qos map premark-dscp <0-63> to {[new-dscp <0-63>] [new-cos <0-7>] [new-queue <0-7>] [new-bandwidth-class{green|yellow|red}]}`
`no mls qos map premark-dscp [<0-63>]`

Parameter	Description
<code>premark-dscp <0-63></code>	The DSCP value on ingress.
<code>new-dscp <0-63></code>	The DSCP value that the packet will have on egress. If unspecified, this value will remain the DSCP ingress value.
<code>new-cos <0-7></code>	The CoS value that the packet will have on egress. If unspecified, this value will retain its value on ingress.
<code>new-queue <0-7></code>	Modify Egress Queue.
<code>new-bandwidth-class</code>	Modify Egress Bandwidth-class. If unspecified, this value will be set to green.
<code>green</code>	Egress Bandwidth-class green (marked down Bandwidth-class).
<code>yellow</code>	Egress Bandwidth-class yellow (marked down Bandwidth-class).
<code>red</code>	Egress Bandwidth-class red (marked down Bandwidth-class).

Mode Global Configuration

Usage With the [“trust dscp” on page 53.75](#) set, this command (`mls qos map premark-dscp`) enables you to make the following changes:

1. remap the dscp (leaving the other settings unchanged)
2. remap any or all of CoS, output queue, or bandwidth class values (leaving the dscp unchanged)

Note  If you attempt to remap both the dscp and another setting, only the dscp remap will take effect.

Example To set the entry for DSCP 1 to use a new DSCP of 2, a new CoS of 3, a new queue of 4 and a new bandwidth class of `yellow`, use the commands:

```
awplus# config terminal
awplus(config)# mls qos map premark-dscp 1 to new-dscp 2
awplus(config)# mls qos map premark-dscp 2 to new-cos 3
awplus(config)# mls qos map premark-dscp 2 to new-queue 4
awplus(config)# mls qos map premark-dscp 2 to new-bandwidth-
class yellow
```

Generic and XEM-2XP Platforms

To reset the entry for DSCP 1 use the command:

```
awplus# config terminal
awplus(config)# no mls qos map premark-dscp 1
```

Related Commands `mls qos map policed-dscp to`
`set dscp`
`show mls qos maps premark-dscp`
`trust dscp`

mls qos queue

Configures the default egress queue for any packet arriving on the specified interface. When no default queue is configured the cos-queue map is used to choose the queue for the packet.

Use the **no** variant of this command to turn off the use of a default queue on the interface.

Syntax `mls qos queue <0-7>`

`no mls qos queue`

Parameter	Description
<0-7>	The particular queue number.

Mode Interface Configuration

Examples To set the default egress queue to 7:

```
awplus# config terminal
awplus(config)# interface port1.0.1
awplus(config-if)# mls qos queue 6
```

To turn off the default mls queue usage on port1.0.1 use the command:

```
awplus# config terminal
awplus(config)# interface port1.0.1
awplus(config-if)# no mls qos queue
```

Related Commands [show mls qos interface](#)

mls qos queue-set

Sets an interface to use the specified queue-set in either taildrop or random-detect mode.

When operating in taildrop mode only the maximum threshold parameters for each bandwidth-class are used from the queue-set. When the actual queue-length for any bandwidth-class exceeds this threshold the packets are discarded instead of being enqueued to the egress port.

When operating in random-detect mode all the parameters from the queue-set are used. The queue-length that is used in this mode is a calculated "average" queue length which can vary depending on what the averaging-factor has been configured to. This provides a more randomized discarding of packets during congestion and prevents TCP global flow synchronization. The down side of this is that more packets are dropped.

By default all ports are assigned to a queue-set created for each class of port (100 M, 1G or 10 G). All ports are also set to operate in taildrop mode. Also all traffic destined for the CPU will use queue-set 4.

Use the **no** variant of this command to reset a queue-set back to its default values. If one or more queues are specified then only those queue's will be reset. Otherwise, if no queue is specified the entire queue-set will be reset.

Syntax `mls qos queue-set <1-4> [random-detect|taildrop]`
`no mls qos queue-set <1-4> queues [0] [1] [2] [3] [4] [5] [6] [7]`

Parameter	Description
<1-4>	Queue-set ID.
random-detect	Apply this queue-set via Weighted Random Detect mode.
taildrop	Apply this queue-set via Taildrop mode.
[0] [1] ...etc	Egress queues.

Mode Interface Configuration

Usage This command is not applied to ports on the XEM-2XP module.

Examples To set port1.0.1 to use queue-set 2 in random-detect mode, use the command:

```
awplus# config terminal
awplus(config)# interface port1.0.1
awplus(config-if)# mls qos queue-set 2 random-detect
```

To reset queue-set 2 back to its default values for queues 1-3 use the command:

```
awplus# config terminal
awplus(config)# no mls qos queue-set 2 queues 1 2 3
```

Related Commands [mls qos queue-set averaging-factor](#)
[mls qos queue-set description](#)

```

mls qos queue-set drop-probability
mls qos queue-set threshold
show mls qos interface
show mls qos queue-set

```

mls qos queue-set averaging-factor

Sets the averaging-factor for the specified queue-set and queue. This determines how quickly the *average* queue length follows the *actual* queue length. With a small averaging-factor, the average queue length follows the actual queue length quickly. As you increase the averaging-factor the average queue length will take longer to follow the actual queue length.

The **queues** parameter is optional and if not specified will default to setting the thresholds for all queues.

This parameter is only valid when a port is using this queue-set in random-detect mode.

Syntax `mls qos queue-set <1-4> queues {0 |1 |2 |3 |4 |5 |6 |7} averaging-factor <0-15>`

Parameter	Description
<1-4>	Queue-set ID.
queues	List of queues to configure. Up to 8 queues (0-7) can be configured within a particular queue set.
averaging-factor	Configure queue length averaging factor.
<0-15>	Averaging factor value.

Mode Global Configuration

Usage This command is not applicable to ports on the XEM-2XP

Example To set the averaging-factor for queues 1-3 in queue-set 1 to be 4, use the command:

```

awplus# config terminal

awplus(config)# mls qos queue-set 1 queues 1 2 3 averaging-
factor 4

```

Related Commands

```

mls qos queue-set
mls qos queue-set description
mls qos queue-set drop-probability
mls qos queue-set threshold
show mls qos interface
show mls qos queue-set

```

mls qos queue-set drop-probability

Sets the drop probability for each bandwidth-class. This probability is the likelihood that a packet is dropped when the average queue length is between the minimum and maximum threshold for that bandwidth class. Once the average queue length is above the maximum threshold the probability jumps to 100%.

The queues parameter is optional and if not specified will default to setting the thresholds for all queues. This parameter is only valid when a port is using this queue-set in random-detect mode.

Syntax `mls qos queue-set <1-4> queues [0] [1] [2] [3] [4] [5] [6] [7]
drop-probability <0-15> <0-15> <0-15>`

Parameter	Description
<1-4>	Queue-set ID.
[0] . . . [7]	List of queues to configure. Up to 8 queues (0-7) can be configured within a particular queue set.
drop-probability	Configure maximum drop probability for each bandwidth-class. See the following Drop Probability table.
<0-15>	Maximum drop-probability factor for green traffic.
<0-15>	Maximum drop-probability factor for yellow traffic.
<0-15>	Maximum drop-probability factor for red traffic.

The drop probability is 100% for a setting of 0 and halves for each integer value increase. The following table shows probability values for drop values of 0 to 7. Default: 1.

Drop Probability

Drop Value	0	1	2	3	4	5	6	7
	100%	50%	25%	12.5%	6.25%	3.125	1.562	0.781
Drop Probability						%	%	%

Mode Global Configuration

Usage This command is not applied to ports on the XEM-2XP module.

Example To set the drop-probability for queues 1-3 in queue-set 2 to be 50%, use the command:

```
awplus# config terminal
awplus(config)# mls qos queue-set 2 queues 1 2 3 drop-
probability 1 1 1
```

The drop-probability parameter specifies the maximum drop-probability for packets when using the random-detect (RED) drop mode. This is the probability that a packet will be dropped when the computed average queue length reaches the Max threshold value setting for a specific traffic class within a specific queue.

The drop-probability is 100% for a drop value of 0, and halves with each increment. For example, a drop1 value of 4 gives a drop probability of 1/16, or 6.25%. The default is 1.

Related Commands `mls qos queue-set`
`mls qos queue-set averaging-factor`
`mls qos queue-set description`
`mls qos queue-set threshold`
`show mls qos interface`
`show mls qos queue-set`

mls qos queue-set description

Sets the description for the specified queue-set. This is a textual string that can be up to 80 characters long.

Syntax `mls qos queue-set <1-4> description <line>`

Parameter	Description
<code><1-4></code>	Queue-set ID.
<code><line></code>	Description up to 80 characters.

Mode Global Configuration

Example To set the description for queue-set 1 to be "Customized defaults", use the command:

```
awplus# config terminal
awplus(config)# mls qos queue-set 1 description "Customized
defaults"
```

Related Commands `mls qos queue-set averaging-factor`
`mls qos queue-set drop-probability`
`mls qos queue-set threshold`
`show mls qos interface`

mls qos queue-set threshold

Sets the threshold parameters for the specified queue-set. There are six threshold parameters, which comprise a minimum and a maximum threshold value for each bandwidth-class.

The queues parameter is optional and if not specified will default to setting the thresholds for all queues. The minimum parameters are only valid when a port is using this queue-set in random-detect mode.

Note that only the **maximum threshold** setting will be applied when tail-drop mode is selected. However you must still enter a value for the **minimum threshold**; one method is to enter the same value for both maximum and minimum entries. See examples.

Syntax `mls qos queue-set <1-4> queues {0|1|2|3|4|5|6|7} threshold
<1-16000000> <1-16000000> <1-16000000> <1-16000000> <1-16000000>
<1-16000000>`

Parameter	Description
<1-4>	Queue-set ID.
queues	List of queues to configure. Up to 8 queues (0-7) can be configured within a particular queue set.
threshold	Configure thresholds.
<1-16000000>	Minimum threshold for green traffic (Bytes).
<1-16000000>	Maximum threshold for green traffic (Bytes).
<1-16000000>	Minimum threshold for yellow traffic (Bytes).
<1-16000000>	Maximum threshold for yellow traffic (Bytes).
<1-16000000>	Minimum threshold for red traffic (Bytes).
<1-16000000>	Maximum threshold for red traffic (Bytes).

Mode Global Configuration

Usage This command is not applied to ports on the XEM-2XP module.

Examples Random Early Discard (RED) Example
To set the thresholds for queues 1-3 in queue-set 1 to a minimum of 1KB and a maximum of 2 KB use the command:

```
awplus# config terminal
awplus(config)# mls qos queue-set 1 queues 1 2 3 threshold
1024 2048 1024 2048 1024 2048
```

Tail Drop Example

To set the thresholds for queue 2 in queue-set 1 to 1KB use the command:

```
awplus# config terminal
awplus(config)# mls qos queue-set 1 queues 2 threshold 1024
1024 1024 1024 1024 1024
```

Related Commands mls qos queue-set
mls qos queue-set averaging-factor
mls qos queue-set description
mls qos queue-set drop-probability
show mls qos interface
show mls qos queue-set

no police

Disables any policer previously configured on the class-map.

Syntax no police

Mode Priority Map Class

Usage This command disables any policer previously configured on the class-map

Example To disable policing on a class-map use the command:

```
awplus# config
awplus(config)# policymap name
awplus(config-pmap)# class classname
awplus(config-pmap-c)# no police
```

Related Commands mls qos map policed-dscp to
police single-rate action
police twin-rate action drop-red
show mls qos maps policed-dscp

police aggregate

Applies a previously created aggregate-policer to the class-map.

Use the **no** variant of this command to remove a previously created aggregate-policer from the class-map.

Syntax `police aggregate <name>`
`no police aggregate <name>`

Parameter	Description
<name>	Specify a aggregate policer name.

Mode Policy Map Class

Usage This command enables you to apply an aggregate policer to a number of different class maps, and meter them as one group. Note that you cannot apply this command to any class map that already has a policer assigned by using the **police single (or twin) rate exceed action** command.

Examples To apply aggregate policer `ap1` to a class-map use the command:

```
awplus# config terminal
awplus(config)# policy-map name
awplus(config-pmap)# class classname
awplus(config-pmap-c)# police aggregate ap1
```

To remove a previously created aggregate-policer from the class-map use the command:

```
awplus# config terminal
awplus(config)# policy-map name
awplus(config-pmap)# class classname
awplus(config-pmap-c)# no police aggregate ap1
```

Related Commands `mls qos aggregate-police action`
`mls qos map premark-dscp to`
`mls qos map policed-dscp to`
`show mls qos aggregate-policer`
`show mls qos maps policed-dscp`

police single-rate action

Configures a single-rate policer for a class-map.

Syntax `police single-rate <cir> <cbs> <ebs> action`
`{drop-red|policed-dscp-transmit}`

Parameter	Description
<code><cir></code>	Specify the Committed Information Rate (CIR) (1-16000000 kbps).
<code><cbs></code>	Specify the Committed Burst Size (CBS) (0-16777216 bytes).
<code><ebs></code>	Specify a Excess Burst Size (EBS) (0-16777216 bytes).
<code>action</code>	Specify the action if rate is exceeded.
<code>drop-red</code>	Drop the red packets.
<code>policed-dscp-transmit</code>	Change packet per policed-dscp map and send it.
<code>policed-dscp-transmit</code>	Modify packets using the <i>policed-dscp map</i> , then transmit. You can configure the remark policed-dscp map using the mls qos map policed-dscp to command on page 53.31 .

Mode Policy Map Class

Usage A policer can be used to meter the traffic classified by the class-map and as a result will be given one of three bandwidth classes. These are green (conforming), yellow (partially-conforming), and red (non-conforming). A single-rate policer is based on three values. These are the average rate, minimum burst and maximum burst.

Color	Definition
green	The traffic rate is less than the average rate and minimum burst.
yellow	The traffic rate is between the minimum burst and the maximum burst.
red	The traffic rate exceeds the average rate and the maximum burst.

Using an action of drop-red means that any packets classed as red will be discarded.

Note  This command will not take effect when applied to a class map that attaches to a channel group whose ports span processor instances.

Example To configure a single rate meter measuring traffic of 10 Mbps that drops any traffic bursting over 1024 bytes of this use the command:

```
awplus# config
awplus(config)# policy-map name
awplus(config-pmap)# class classname
awplus(config-pmap-c)# police single-rate 10000 512 1024 action
drop-red
```

Related Commands mls qos map policed-dscp to
no police
police twin-rate action drop-red
show mls qos maps policed-dscp

police twin-rate action drop-red

Configures a twin-rate policer for a class-map.

Syntax `police twin-rate <cir> <pir> <pbs> <pbs> action {drop-red|policed-dscp-transmit|}`

Parameter	Description
<code><cir></code>	Specify the Committed Information Rate (CIR) (1-16000000 kbps).
<code><pir></code>	Specify the Peak Information Rate (PIR) (kbps).
<code><pbs></code>	Specify the Peak Burst Size (PBS) (0-16777216 bytes).
<code>action</code>	Specify the action if rate is exceeded.
<code>drop-red</code>	Drop the packet.
<code>policed-dscp-transmit</code>	Change packet per policed-dscp map and send it.

Mode Policy Map Class

Usage A policer can be used to meter the traffic classified by the class-map and as a result will be given one of three bandwidth classes. These are green (conforming), yellow (partially-conforming), and red (non-conforming).

A twin-rate policer is based on four values. These are the minimum rate, minimum burst size, maximum rate, and maximum burst size.

Bandwidth Class	Definition
<code>green</code>	The sum of the number of existing (buffered) bytes plus those arriving at the port per unit time, result in a value that is less than that set for the CBS.
<code>yellow</code>	The sum of the number of existing (buffered) bytes plus those arriving at the port per unit time, result in a value that is between those set for the CBS and the PBS
<code>red</code>	The sum of the number of existing (buffered) bytes plus those arriving at the port per unit time, result in a value that exceeds that set for the PBS

Using an action of drop-red means that any packets classed as red will be discarded.

When using an action of policed-dscp-transmit the packet will be remarked with the values configured in the policed-dscp map. The index into this map is determined by the DSCP in the packet. If a DSCP index is to be forced regardless of the packet DSCP the `set dscp` command can be used to achieve this. If no DSCP is present in the packet an index of 0 will be used.

Example To configure a twin rate meter measuring a minimum rate of 10 Mbps and a maximum rate of 20 Mbps that uses the policed-dscp map to remark any non-conforming traffic, use the command: bursting over 1024 bytes of this use the command:

```
awplus# config
awplus(config)# policy-map name
awplus(config-pmap)# class classname
awplus(config-pmap-c)# police twin-rate 10000 20000 1024 1024
                        action policed-dscp-transmit
```

Related Commands mls qos map policed-dscp to
no police
police twin-rate action drop-red
show mls qos maps policed-dscp

policy-map

Use this command to create a policy map and to enter Policy Map Configuration mode to configure the specified policy map.

Use the **no** variant of this command to delete an existing policy map.

Syntax `policy-map <name>`
`no policy-map <name>`

Parameter	Description
<code><name></code>	Name of the policy map.

Mode Global Configuration

Example To create a policy-map called `pmap1` use the commands

```
awplus# configure terminal
awplus(config)# policy-map pmap1
awplus(config-pmap)#
```

Related Commands [class-map](#)

priority-queue

Configures strict priority based scheduling on the specified egress queues. You must specify at least one queue.

Syntax `priority-queue {1} [2] [3] [4] [5] [6] [7] [8]`

Parameter	Description
<code>1 to 8</code>	Specify the queues to apply the scheduling rule.

Mode Interface Configuration

Example To apply priority based scheduling to egress queues 5, 6 and 7 use the following commands:

```
awplus# configure terminal
awplus(config)# interface port1.1.12
awplus(config-if)# priority-queue 5 6 7
```

service-policy input

Use this command to apply a policy map to the input of an interface.

Use the **no** variant of this command to remove a policy map and interface association.

Syntax `service-policy input <policy-map>`
`no service-policy input <policy-map>`

Parameter	Description
<code><policy-map></code>	Policy map name that the input will applied to.

Mode Interface Configuration

Usage This command can be applied to switch ports or static channel groups, but not to dynamic (LACP) channel groups.

Example To apply a policy map named `pmap1` to interface `port1.1.2`:

```
awplus# configure terminal
awplus(config)# interface port1.1.2
awplus(config-if)# service-policy input pmap1
```

set bandwidth-class

Use this command to set a bandwidth-class color to assign to classified traffic. The color represents the traffic's conformance to the policers allocated bandwidth. Green traffic is assumed to be conforming, yellow is semi-conforming, and red is non-conforming.

Use the **no** variant of this command to negate turn off a bandwidth-class color assigned to classified traffic.

Syntax `set bandwidth-class {green|yellow|red}`
`no set bandwidth-class {green|yellow|red}`

Parameter	Description
green	Mark the packet as green.
yellow	Mark the packet as yellow.
red	Mark the packet as red.

Mode Policy Map Class

Examples To set the bandwidth class for all traffic classified by this class-map use the command:

```
awplus# configure terminal
awplus(config)# policy-map pmap1
awplus(config-pmap)# class cmap1
awplus(config-pmap-c)# set bandwidth-class green
```

Note that the class-map and p-maps should already have been created by using the [class-map command on page 53.4](#) and the [policy-map command on page 53.48](#).

To turn off the setting of a packets in the green bandwidth-class, for the policy `pmap1` and the class `cmap1`, use the command:

```
awplus# configure terminal
awplus(config)# policy-map pmap1
awplus(config-pmap)# class cmap1
awplus(config-pmap-c)# no set bandwidth-class green
```

Related Commands [class-map](#)
[set cos](#)
[set dscp](#)
[set queue](#)
[trust dscp](#)

set cos

Use this command to set a CoS value to assign to classified traffic.

Use the no variant of this command to turn off the CoS value assigned to classified traffic.

Note that this command is not valid with [trust dscp](#).

Syntax `set cos <0-7>`

`no set cos`

Parameter	Description
<code><0-7></code>	The new CoS value to be assigned.

Mode Policy Map Class

Examples To set the CoS value to 7 for all traffic classified by the selected class-map and policy-map use the command:

```
awplus# configure terminal
awplus(config)# policy-map pmap1
awplus(config-pmap)# class cmap1
awplus(config-pmap-c)# set cos 7
```

To turn off the above setting, use the command:

```
awplus# configure terminal
awplus(config)# policy-map pmap1
awplus(config-pmap)# class cmap1
awplus(config-pmap-c)# no set cos
```

Related Commands [set bandwidth-class](#)
[set dscp](#)
[set queue](#)
[set dscp](#)

set dscp

For a specific class-map and policy-map this command will assign or change the DSCP value within the packet. Note that where more than one class map has been assigned to a particular DSCP, the switch will apply the action of the class-map that was created first.

If `trust dscp` has also been specified, the value determined by the `set dscp` command (i.e. that assigned to the class map and policy map) will be the value that is used by the lookup process in the premark-dscp mapping. The result of the lookup will then be assigned to the traffic.

The `no` variant of this command will negate the DSCP value specified with the `set dscp` command.

Syntax `set dscp <0-63>`

`no set dscp`

Parameter	Description
<code><0-63></code>	The new DSCP value. A value between 0 and 63.

Mode Policy Map Class

Example To set a DSCP value of 35 to all traffic classified by a class-map of `cmap1` and a policy map of `pmap1`, use the command:

```
awplus# configure terminal
awplus(config)# policy-map pmap1
awplus(config-pmap)# class cmap1
awplus(config-pmap-c)# set dscp 35
```

Related Commands `set bandwidth-class`
`set cos`
`set dscp`
`set queue`
`trust dscp`

set ip next-hop (PBR)

Forwards traffic matching this class map to the specified nexthop.

When this command is set, all packets that match a selected class map will be forwarded to the specified nexthop.

The **no** variant of this command removes the next-hop address (in the context of its policy-map and class-map) from the configuration.

Syntax `set ip next-hop <ip-addr>`

`no set ip next-hop`

Parameter	Description
<ip-addr>	The IP address of the next hop destination.

Mode Policy Map Class

Usage In typical deployments of policy-based routing, some traffic types require normal routing (i.e. via the routes in the IP routing table) while other traffic types require policy based routing.

Where the traffic to be policy routed is a subset of the traffic that is to be normally routed, then the configuration is reasonably simple. The policy-map will contain one or more classes that match the traffic to be policy routed, and will have their next-hop configured by this command - **set ip next-hop (PBR)**. The remaining traffic will be conventionally routing routed according to the rules set for the default class - providing that this is not subject to the **set ip next-hop (PBR)**.

The situation becomes a little more complex where the traffic requiring normal routing is a subset of the traffic to be policy-routed. In this situation the policy-map would need to contain one, or more, classes that match the requirement for normal routing. These classes would not be configured with a **set ip next-hop (PBR)** command. Then the remaining traffic classes that require normal routing would have the **set ip next-hop (PBR)** command applied to them. Note that this traffic could be just the default class, if ALL other traffic types were to be policy-routed.

Also note that the order in which the classes are configured in the policy-map is important; because traffic is matched against the classes in the order that they were assigned to the policy map.

Details of a practical example of such a policy-based routing is shown in [“Policy-Based Routing” on page 52.36](#).

Example To forward a packet to a 192.168.1.1 use the commands:

```
awplus# configure terminal
awplus(config)# policy-map pmap1
awplus(config-pmap)# class cmap1
awplus(config-pmap-c)# set ip next-hop 192.168.1.1
```

Related Commands [set bandwidth-class](#)
[set cos](#)
[set dscp](#)
[set queue](#)

set queue

Use this command to set a queue value to assign to classified traffic. This will override the default queue as configured by [mls qos queue command on page 53.36](#), but may be overridden by subsequent QoS mechanisms (such as remarking).

Use the **no** variant of this command to negate the queue value assigned to classified traffic by the [set queue](#) command.

This command is not valid if the [trust dscp command on page 53.75](#) is set.

Syntax `set queue <0-7>`
`no set queue`

Parameter	Description
<0-7>	Specify a new Queue value.

Mode Policy Map Class

Example To set the queue to value 7 for all traffic classified as `cmap1` and `pmap1`, use the command:

```
awplus# configure terminal
awplus(config)# policy-map pmap1
awplus(config-pmap)# class cmap1
awplus(config-pmap-c)# set queue 7
```

Related Commands [set bandwidth-class](#)
[set cos](#)
[set dscp](#)
[trust dscp](#)

show class-map

Use this command to display the QoS class maps to define the match criteria to classify traffic.

Syntax `show class-map <class-map name>`

Parameter	Description
<code><class-map name></code>	Name of the class map.

Mode User Exec and Privileged Exec

Example To display the QoS class maps to define the match criteria to classify traffic, use the command:

```
awplus# show class-map cmap1
```

Output Figure 53-2: Example output from the `show class-map` command

```
CLASS-MAP-NAME: cmap1
  Set IP DSCP: 56
  Match IP DSCP: 7
```

Related Commands [class-map](#)

show mls qos aggregate-policer

Displays all or a single aggregate-policer. If no name is specified, all aggregate policers will be displayed.

Syntax `show mls qos aggregate-policer [<name>]`

Parameter	Description
<name>	Aggregate policer name.

Mode User Exec and Privileged Exec

Example To display all aggregate-policers, use the command:

```
awplus# show mls qos aggregate-policer
```

Output Figure 53-3: Example output from the `show mls qos aggregate-policer` command

```
AGGREGATE-POLICER-NAME: ap1
Policer single-rate action drop-red:
average rate(1 kbps) minimum burst(2 B) maximum burst(3 B)
AGGREGATE-POLICER-NAME: ap2
Policer twin-rate action drop-red policed-dscp-tx:
minimum rate(1 kbps) maximum rate(2 kbps) minimum burst(3 B)
maximum burst(4 B)
```

Related Commands `mls qos aggregate-police action`
`police aggregate`

show mls qos fabric-queue

Displays the scheduling algorithms for the fabric queues.

Syntax `show mls qos fabric-queue`

Mode User Exec and Privileged Exec

Example To display all scheduling algorithms for the fabric-queues, use the command:

```
awplus# show mls qos fabric-queue
```

Output Figure 53-4: Example output from the `show mls qos fabric-queue` command

```
fabric queue: 0
Scheduler: WRR
Weight: 5
Fabric Queue: 1
Scheduler: WRR
Weight: 1
Fabric Queue: 2
Scheduler: Priority
Fabric Queue: 3
Scheduler: Priority
```

Related Commands [mls qos fabric-queue](#)
[show mls qos maps fabric-queue](#)

show mls qos interface

Displays the current settings for the interface. This includes its default CoS and queue, scheduling used for each queue, and any policies/maps that are attached.

Syntax `show mls qos interface [<port>]`

Parameter	Description
<port>	Switch port.

Mode User Exec and Privileged Exec

Example To display current CoS and queue settings for interface `port1.0.1`, use the command:

```
awplus# show mls qos interface port1.0.1
```

Output Figure 53-5: Example output from the `show mls qos interface` command

```

Default CoS: 7
Default Queue: 7
Number of egress queues: 8
Queue Set: 1
Egress Queue: 0
  Status: Enabled
  Scheduler: Strict Priority
  Queue Limit: 12%
  Egress Rate Limit: 0 Kb
Egress Queue: 1
  Status: Enabled
  Scheduler: Strict Priority
  Queue Limit: 12%
  Egress Rate Limit: 0 Kb
Egress Queue: 2
  Status: Enabled
  Scheduler: Strict Priority
  Queue Limit: 12%
  Egress Rate Limit: 0 Kb
Egress Queue: 3
  Status: Enabled
  Scheduler: Wrr Group 2
  Weight: 10
  Queue Limit: 12%
  Egress Rate Limit: 0 Kb
Egress Queue: 4
  Status: Enabled
  Scheduler: Wrr Group 1
  Weight: 10
  Queue Limit: 12%
  Egress Rate Limit: 0 Kb
Egress Queue: 5
  Status: Enabled
  Scheduler: Strict Priority
  Queue Limit: 12%
  Egress Rate Limit: 0 Kb
Egress Queue: 6
  Status: Enabled
  Scheduler: Strict Priority
  Queue Limit: 12%
  Egress Rate Limit: 0 Kb
Egress Queue: 7
  Status: Enabled
  Scheduler: Strict Priority
  Queue Limit: 12%
  Egress Rate Limit: 0 Kb

```

Table 53-1: Parameters in the output of the `show mls qos interface` command

Parameter	Description
Default CoS	The default CoS priority that will be applied to all packets arriving on this interface.
Default Queue	The default queue that will be applied to all packets arriving on this interface.
Number of egress queues	The total number of egress queues available on this interface.
Queue Set	Drop queue set that has been applied to the port. This could either be operating in threshold or random-detect mode.
Egress Queue X	Number of this egress queue.
Status	Queue can either be enabled or disabled.
Scheduler	The scheduling mode being used for servicing the transmission of packets on this port.

Table 53-1: Parameters in the output of the `show mls qos interface` command (cont.)

Parameter	Description
Queue Limit	The percentage of the ports buffers that have been allocated to this queue.
Egress Rate Limit	The amount of traffic that can be transmitted via this queue per second. 0 Kb means there is currently no rate-limiting enabled.

Related Commands `mls qos queue`
`wrr-queue group weight queues`
`wrr-queue queue-limit`

show mls qos interface policer-counters

Display an interface's policer counters. This can either be for a specific class-map or for all class-maps attached to the interface. If no class-map is specified all class-map policer counters attached to the interface will be displayed.

These are the counters based on metering performed on the specified class-map. Therefore, the 'Dropped packets' counter is the number of bytes dropped due to metering. This is different from the packets dropped via a 'deny' action in the ACL.

You must enable the QoS counter platform enhancemode before running this command.

Syntax `show mls qos interface <port> policer-counters`
`[class-map <class-map>]`

Parameter	Description
<port>	Switch port.
class-map	Select a class-map.
<class-map>	Class-map name.

Mode User Exec and Privileged Exec

Example To show the counters for all class-maps attached to `port1.0.1` enter the command

```
awplus# show mls qos interface port1.0.1 policer-counters
```

Output **Figure 53-6: Example output from the `show mls qos interface policer-counters` command**

```
Interface:          port1.0.1
Class-map:         cmap1
Aggregate Bytes:   128
Green Bytes:       128
Yellow Bytes:      0
Red Bytes:         0
Dropped Bytes:     0
```

Related Commands `mls qos queue`
`wrr-queue group weight queues`
`wrr-queue queue-limit`

show mls qos interface queue-counters

Display an interface's egress queue counters. This can either be for a specific queue or for all queues on the interface. If no queue is specified all queue counters on the interface will be displayed.

The counters show the number of frames currently in the queue and the maximum number of frames allowed in the queue, for individual egress queues and the port's queue (which will be a sum of all eight egress queues).

Syntax `show mls qos interface <port> queue-counters queue [<0-7>]`

Parameter	Description
<port>	Switch port.
<0-7>	Queue.

Mode User Exec and Privileged Exec

Usage The output of this command is now device specific. **Specific output** applies to switch ports on the XEM-2XP module, **generic output** applies to all other switch ports.

On the XEM-2XP, the maximum value of 219 represents (73+73+73) frames, where the value 73 (219 divided by 3) is the drop precedence, red, green, and yellow. It is therefore possible that for unmetered traffic (where all traffic is treated as being green) the queue length of 73 frames could be exceeded. Note also that the figure of 219 shown in the example is derived from the settings made in the [wrr-queue queue-limit command on page 53.80](#) command.

Example Generic Port

To show the counters for all queues on `port1.0.1` enter the command:

```
awplus# show mls qos interface port1.0.1 queue-counters
```

Output Generic Ports

Figure 53-7: Example output from the `show mls qos interface queue-counters` command

```
Interface port1.0.1 Queue Counters:
  Port queue length      0 (maximum 896)
  Egress Queue length:
    Queue 0              0 (maximum 112)
    Queue 1              0 (maximum 112)
    Queue 2              0 (maximum 112)
    Queue 3              0 (maximum 112)
    Queue 4              0 (maximum 112)
    Queue 5              0 (maximum 112)
    Queue 6              0 (maximum 112)
    Queue 7              0 (maximum 112)
```

Output
XEM-2XP Ports

Figure 53-8: Example output from the `show mls qos interface queue-counters` command

```

Interface port1.1.1 Queue Counters:
  Port queue length      0 (maximum 600)
  Egress Queue length:
    Queue 0              0 (maximum 219)
    Queue 1              0 (maximum 219)
    Queue 2              0 (maximum 219)
    Queue 3              0 (maximum 219)
    Queue 4              0 (maximum 219)
    Queue 5              0 (maximum 219)
    Queue 6              0 (maximum 219)
    Queue 7              0 (maximum 219)
    
```

Table 53-2: Parameters in the output of the `show mls qos interface queue-counters` command

Parameter	Description
Interface	Port we are showing the counters for
Port queue length	Number of frames in the port's queue. This will be the sum of all egress queues on the port.
Egress Queue length	Number of frames in a specific egress queue, subject to the specific operation on the XEM-2XP module - see Usage Section.

Related Commands `wrr-queue queue-limit`

show mls qos interface storm-status

Show the current configuration and status of the QoS Storm Protection (QSP) on the given port.

Syntax `show mls qos interface <port> storm-status`

Parameter	Description
<port>	Switch port.

Mode User Exec and Privileged Exec

Example To see the QSP status on port1.0.1, use command:

```
awplus# show mls qos interface port1.0.1 storm-status
```

Output Figure 53-9: Example output from the `show mls qos interface storm-status` command

```
Interface:          port1.0.1
Storm-Protection:   Enabled
Port-status:        Enabled
Storm Action:       vlandisable
Storm Window:       5000 ms
Storm Downtime:     0 s
Timeout Remaining: 0 s
Last read data-rate: 0 kbps
Storm Rate:         1000 kbps
```

Related Commands

- [storm-action](#)
- [storm-downtime](#)
- [storm-protection](#)
- [storm-rate](#)
- [storm-window](#)

show mls qos maps cos-queue

Show the current configuration of the cos-queue map.

Syntax `show mls qos maps cos-queue`

Mode User Exec and Privileged Exec

Example To display the current configuration of the cos-queue map, use the command:

```
awplus# show mls qos maps cos-queue
```

Output Figure 53-10: Example output from the `show mls qos maps cos-queue` command

COS-TO-QUEUE-MAP:							
COS :	0	1	2	3	4	5	6 7

QUEUE:	0	7	1	3	4	5	6 7

Related Commands `mls qos map cos-queue to`

show mls qos maps fabric-queue

Displays the fabric queue map, which is a table mapping eight egress queues to four input fabric queues.

Syntax `show mls qos maps fabric-queue`

Mode User Exec and Privileged Exec

Example To display the `fabric-queue` map, use the command:

```
awplus# show mls qos maps fabric-queue
```

Output Figure 53-11: Example output from the `show mls qos maps fabric-queue` command

Egress Queue	Fabric Queue
0	0
1	0
2	1
3	1
4	2
5	2
6	3
7	3

Output Parameter	Meaning
Egress Queue	Egress queue indexing the table
Fabric Queue	Resulting fabric queue for the egress queue lookup.

Related Commands `mls qos fabric-queue`
`mls qos map fabric-queue`
`show mls qos fabric-queue`

show mls qos maps policed-dscp

Displays the policed-dscp map. This is used when a policer is configured with an exceed action of 'policed-dscp-transmit'.

Syntax `show mls qos maps policed-dscp [<0-63>]`

Parameter	Description
<0-63>	DSCP table entry.

Mode User Exec and Privileged Exec

Example To display the policed-dscp map for DSCP 1 enter the command:

```
awplus# show mls qos maps policed-dscp 1
```

Output Figure 53-12: Example output from the `show mls qos maps policed-dscp` command

```
POLICED-DSCP-MAP:
DSCP 1
Bandwidth Class Green Yellow Red
-----
New DSCP 1 1 1
New CoS 0 0 0
New Queue 0 0 0
New Bandwidth Class green yellow red
```

Related Commands `mls qos map premark-dscp to no police`
`police single-rate action`
`police twin-rate action drop-red`

show mls qos maps premark-dscp

Displays the premark-dscp map. This map is used when the [trust dscp](#) command has been specified for a policymap's class-map to replace the DSCP, CoS, queue, and bandwidth class of a packet matching the class-map based on a lookup DSCP value.

If the [set dscp](#) command has also been specified for that class-map, the set value is used for the lookup of the premark-dscp map. Otherwise the DSCP value in the packet is used for the lookup.

Syntax `show mls qos maps premark-dscp [<0-63>]`

Parameter	Description
<0-63>	DSCP table entry.

Mode User Exec and Privileged Exec

Example To display the premark-dscp map for DSCP 1 enter the command:

```
awplus# show mls qos maps premark-dscp 1
```

Output [Figure 53-13: Example output from the show mls qos maps premark-dscp command](#)

```
PREMARK-DSCP-MAP:
  DSCP 1
  Bandwidth Class      Green   Yellow  Red
  -----
  New DSCP              1      -      -
  New CoS               0      -      -
  New Queue             0      -      -
  New Bandwidth Class  green  -      -
```

Related Commands [mls qos map premark-dscp to set dscp](#)
[trust dscp](#)

show mls qos queue-set

Displays the specified queue-set and its parameters. If no queue-set is specified then all queue sets will be displayed.

Syntax `show mls qos queue-set [<1-4>]`

Parameter	Description
<1-4>	Queue Set ID.

Mode User Exec and Privileged Exec

Usage This show output is invalid for ports on the XEM-2XP module.

Example To display `queue-set 1` use the command:

```
awplus# show mls qos queue-set 1
```

Output Figure 53-14: Example output from the `show mls qos queue-set` command

```

Queue Set 1:
  Description: 1G Defaults

Probability      BandwidthClass  Min           Max           Drop
-----
Queue 0         | Green          100 KB        125 KB        1 (50%)
                | Yellow         100 KB        125 KB        1 (50%)
                | Red            100 KB        125 KB        1 (50%)
-----
Queue 1         | Green          100 KB        125 KB        1 (50%)
                | Yellow         100 KB        125 KB        1 (50%)
                | Red            100 KB        125 KB        1 (50%)
-----
Queue 2         | Green          100 KB        125 KB        1 (50%)
                | Yellow         100 KB        125 KB        1 (50%)
                | Red            100 KB        125 KB        1 (50%)
-----
Queue 3         | Green          100 KB        125 KB        1 (50%)
                | Yellow         100 KB        125 KB        1 (50%)
                | Red            100 KB        125 KB        1 (50%)
-----
Queue 4         | Green          100 KB        125 KB        1 (50%)
                | Yellow         100 KB        125 KB        1 (50%)
                | Red            100 KB        125 KB        1 (50%)
-----
Queue 5         | Green          100 KB        125 KB        1 (50%)
                | Yellow         100 KB        125 KB        1 (50%)
                | Red            100 KB        125 KB        1 (50%)
-----
Queue 6         | Green          100 KB        125 KB        1 (50%)
                | Yellow         100 KB        125 KB        1 (50%)
                | Red            100 KB        125 KB        1 (50%)
-----
Queue 7         | Green          100 KB        125 KB        1 (50%)
                | Yellow         100 KB        125 KB        1 (50%)
                | Red            100 KB        125 KB        1 (50%)
-----

Queue Length Averaging Factor
Queue 0: 9
Queue 1: 9
Queue 2: 9
Queue 3: 9
Queue 4: 9
Queue 5: 9
Queue 6: 9
Queue 7: 9

```

Table 53-3: Parameters in the output of the `show mls qos queue-set` command

Parameter	Description
Queue Set	queue-set number.
Description	Textual description for this queue-set.
Queue X	Parameter set for egress queue X.
BandwidthClass	Parameter set per-bandwidth-class per-queue.
Min	The amount of traffic required in the queue before packets start getting dropped.
Max	The amount of traffic required in the queue before all packets are dropped.
Drop Probability	The probability that a packet is dropped when the queue length is between the minimum and maximum for the bandwidth-class.
Averaging Factor	Determines how quickly the average queue length follows the actual queue length. A small averaging factor will cause the average to follow the actual more quickly and visa versa for a large averaging factor.

Related Commands

- `mls qos queue-set`
- `mls qos queue-set averaging-factor`
- `mls qos queue-set description`
- `mls qos queue-set drop-probability`
- `mls qos queue-set threshold`
- `show mls qos interface`
- `show mls qos queue-set`

show policy-map

Displays the policy-maps configured on the switch. The output also shows whether or not they are connected to a port (attached / detached) and shows their associated class-maps.

Syntax `show policy-map [<name>]`

Parameter	Description
<name>	The name of a specific policy map.

Mode User Exec and Privileged Exec

Example To display a listing of the policy-maps configured on the switch:

```
awplus# show policy-map
```

Output Figure 53-15: Example output from the `show policy-map` command

```
POLICY-MAP-NAME: general-traffic
State: attached
  Default class-map action: permit
CLASS-MAP-NAME: default
CLASS-MAP-NAME: database-traffic
```

Related Commands `no police`
`service-policy input`

storm-action

Sets the action to take when triggered by QoS Storm Protection (QSP). There are three available options:

- **portdisable** will disable the port in software.
- **vlandisable** will disable the port from the VLAN matched by the class-map in class-map.
- **linkdown** will physically bring the port down. The **vlandisable** requires the match vlan class-map to be present in the class-map.

The **no** variant of this command will negate the action set by the **storm-action** command.

Syntax `storm-action {portdisable|vlandisable|linkdown}`
`no storm-action`

Parameter	Description
<code>portdisable</code>	Disable the port in software.
<code>vlandisable</code>	Disable the VLAN.
<code>linkdown</code>	Shutdown the port physically.

Mode Policy Map Class

Example To apply the storm protection of `vlandisable` to the policy map named `pmap2`, and the class-map named `cmap1`, use commands:

```
awplus(config)# policy-map pmap2
awplus(config-pmap)# class cmap1
awplus(config-pmap-c# storm-action vlandisable
```

Related Commands `storm-downtime`
`storm-protection`
`storm-rate`
`storm-window`

storm-downtime

Sets the time to re-enable the port once disabled by QoS Storm Protection (QSP). The time is given in seconds, from a minimum of one second to maximum of 86400 seconds (i.e. one day).

The **no** variant of this command resets the time to the default, 10 seconds.

Syntax `storm-downtime <1-86400>`

`no storm-downtime`

Parameter	Description
<code><1-86400></code>	Seconds.

Default 10 seconds

Mode Policy Map Class

Example To re-enable the port in 1 minute, use command:

```
awplus(config)# policy-map pmap2
awplus(config-pmap)# class cmap1
awplus(config-pmap-c)# storm-downtime 60
```

Related Commands [storm-action](#)
[storm-protection](#)
[storm-rate](#)
[storm-window](#)

storm-protection

Enables the Policy Based Storm Protection (such as QSP - QoS Storm Protection). Storm protection is activated on a port after port state decisions have been made.

The **no** variant of this command disables Policy Based Storm Protection.

Syntax `storm-protection`
`no storm-protection`

Mode Policy Map Class

Example To enable QSP on `cmap2` in `pmap2`, use the commands:

```
awplus# policy-map pmap2
awplus(config-pmap)# class cmap2
awplus(config-pmap-c)# storm-protection
```

Related Commands [storm-action](#)
[storm-downtime](#)
[storm-rate](#)
[storm-window](#)

storm-rate

Sets the data rate that triggers the storm-action. The rate is in kbps and the range is from 1kbps to 10Gbps.

Note that this setting is made in conjunction with the **storm window** command.

Use the **no** variant of this command to negate the **storm-rate** command.

Syntax `storm-rate <1-10000000>`

`no storm-rate`

Parameter	Description
<code><1-10000000></code>	The range of the storm-rate.

Default No default

Mode Policy Map Class

Usage This setting is made in conjunction with the [storm-window command on page 53.74](#).

Example To the limit to 1Mbps, use the commands:

```
awplus# policy-map pmap2
awplus(config-pmap)# class cmap2
awplus(config-pmap-c)# storm-rate 1000
```

Related Commands [storm-action](#)
[storm-downtime](#)
[storm-protection](#)
[storm-window](#)

storm-window

Sets the window size of QoS Storm Protection (QSP). This sets the time to poll the data-rate every given milliseconds. Minimum window size of 100 ms and the maximum is 60 sec.

Use the **no** variant of this command to negate the **storm-window** command.

Syntax `storm-window <100-60000>`
`no storm-window`

Parameter	Description
<code><100-60000></code>	The window size, measured in milliseconds.

Default No default

Mode Policy Map Class

Usage This command should be set in conjunction with the [storm-rate command on page 53.73](#).

Example To set the QSP window size to 5000 ms, use the commands:

```
awplus(config)# policy-map pmap2
awplus(config-pmap)# class cmap2
awplus(config-pmap-c)# storm-window 5000
```

Related Commands [storm-action](#)
[storm-downtime](#)
[storm-protection](#)
[storm-rate](#)

trust dscp

On switch ports other than the XEM-2XP, this command enables the premark-dscp map to replace the bandwidth-class, cos, dscp, and queue of classified traffic based on a lookup DSCP value.

With the **no** variant of this command, no premark-dscp mapping function will be applied for the selected class-map. QoS components of the packet existing either at ingress, or applied by the class-map, will pass unchanged.

Syntax `trust dscp`
`no trust dscp`

Mode Policy Map Class

Usage If the `set dscp` command has also been specified for the class-map, the set value is used for the lookup of the premark-dscp map. Otherwise the DSCP value in the packet is used for the lookup.

Note that the set bandwidth-class, set cos and set queue are not valid with **trust dscp**.

Example To enable the premark-dscp map lookup use the command:

```
awplus# configure terminal
awplus(config)# policy-map pmap
awplus(config-pmap)# class cmap1
awplus(config-pmap-c)# trust dscp
```

Related Commands `mls qos map premark-dscp to`
`set bandwidth-class`
`set cos`
`set dscp`
`set queue`
`trust dscp (XEM-2XP)`

trust dscp (XEM-2XP)

On the XEM-2XP module, use this command to enable the premark-dscp map to replace the bandwidth-class, cos, dscp, and queue of classified traffic within a policy-map based on a lookup DSCP value.

With the **no** variant of this command, no premark-dscp mapping function will be applied for the selected policy-map. QoS components of the packet existing at ingress will pass unchanged.

Syntax `trust dscp`
`no trust dscp`

Mode Policy Map

Usage The DSCP value in the packet is used for lookup, regardless of whether the policy-map has any class-map (with an assigned DSCP) attached to it.

Example To enable the premark-dscp map lookup use the command:

```
awplus# configure terminal
awplus(config)# policy-map pmap1
awplus(config-pmap)# trust dscp
```

Related Commands `mls qos map premark-dscp to`
`set bandwidth-class`
`set cos`
`set dscp`
`set queue`
`trust dscp`

wrr-queue disable queues

The command `wrr-queue disable queues` disables an egress queue from transmitting traffic.

The command `no wrr-queue disable queues` enables an egress queue to transmit traffic.

Syntax `wrr-queue disable queues [0] [1] [2] [3] [4] [5] [6] [7]`
`no wrr-queue disable queues [0] [1] [2] [3] [4] [5] [6] [7]`

Parameter	Description
[1] [2] . . . [7]	Selects one or more queues numbered 0 to 7.

Mode Interface Configuration

Examples To enable queues 1-3 to transmit traffic use the commands:

```
awplus# configure terminal
awplus(config)# interface port1.0.1
awplus(config-if)# no wrr-queue disable queues 1 2 3
```

To disable queues 1-3 from transmitting traffic use the commands:

```
awplus# configure terminal
awplus(config)# interface port1.0.1
awplus(config-if)# wrr-queue disable queues 1 2 3
```

Related Commands [show mls qos interface](#)

wrr-queue egress-rate-limit queues

Sets a limit on the amount of traffic that can be transmitted per second from these queues. The default unit is in Kb, but Mb or Gb can also be specified. The minimum is 651Kb.

Syntax `wrr-queue egress-rate-limit <bandwidth> queues
[0] [1] [2] [3] [4] [5] [6] [7]`

`no wrr-queue egress-rate-limit <bandwidth> queues
[0] [1] [2] [3] [4] [5] [6] [7]`

Parameter	Description
<bandwidth>	Bandwidth <1-10000000 kbits> (usable units: k, m, g).
[1] [2] . . . [7]	Selects one or more queues numbered 0 to 7.

Mode Interface Configuration

Example To set enable egress rate limiting on queues 1-3 enter the commands:

```
awplus# configure terminal
awplus(config)# interface port1.0.1
awplus(config-if)# wrr-queue egress-rate-limit 500M
queues 1 2 3
```

Related Commands `show mls qos interface`

wrr-queue group weight queues

Configures weighted round-robin based scheduling on the specified egress queues. The queues can be placed into either group 1 or group 2. Both groups are still serviced in a round-robin order according to the specified weights, but all queues in group 1 must be empty before any packets in group 2 can be sent. The weights are specified as ratios relative to each other. Note that ports within a round robin group must be contiguous.

Syntax `wrr-queue group <1-2> weight <6-255> queues [0] [1] [2] [3] [4] [5] [6] [7]`

Parameter	Description
<1-2>	Wrr group 1 or 2.
<6-255>	Weight.
[0] [1] . . . [7]	Egress queues 0-7.

Mode Interface Configuration

Example To configure wrr-queue group 1 weight 6 queues 0 1 2, use the following commands:

```
awplus# configure terminal
awplus(config)# interface port1.0.1
awplus(config-if)# wrr-queue group 1 weight 6 queues 0 1 2
```

Related Commands [priority-queue](#)
[show mls qos interface](#)

wrr-queue queue-limit

Sets the percentages of a ports total buffer pool that each queue is allowed to use. This queue limit is applicable no matter what type of scheduling is configured for the specified queues (i.e. WRR or strict priority).

Syntax `wrr-queue queue-limit <1-100> <1-100> <1-100> <1-100> <1-100> <1-100> <1-100> <1-100>`
`no wrr-queue queue-limit <1-100> <1-100> <1-100> <1-100> <1-100> <1-100> <1-100> <1-100>`

Parameter	Description
<1-100>	Queue ratio for Queue 0.
<1-100>	Queue ratio for Queue 1.
<1-100>	Queue ratio for Queue 2.
<1-100>	Queue ratio for Queue 3.
<1-100>	Queue ratio for Queue 4.
<1-100>	Queue ratio for Queue 5.
<1-100>	Queue ratio for Queue 6.
<1-100>	Queue ratio for Queue 7.

Mode Interface Configuration

Usage Note that for ports on the XEM-2XP module, the portion of the port's buffer pool that is assigned to each queue is divided by three, with one third applied to each of the three drop precedence colors, red, green, and yellow.

Where no color metering is applied, the queue limit is effectively reduced to a third of the configured value, because in this situation all traffic is classed as green. For example, if the overall queue size available is 792 frames, and equal portions (12.5% of 792 = 99 frames) are assigned to each queue, then 33 frames are assigned to each of the three drop precedence colors. Where no color metering is applied, all traffic is (by default) defined as green, and so is allocated 33 frames per queue. Tail dropping is then applied when each queue is only one third full.

On ports other than the XEM-2XP, no per precedence queuing is applied; therefore in the above example all 99 frames per queue would be available.

Example To configure a wrr-queue queue-limit on port1.0.1 to port1.0.12 for each queue, use the following commands:

```
awplus# configure terminal
awplus(config)# interface port1.0.1-port1.0.12
awplus(config-if)# wrr-queue queue-limit 12 12 12 12 12 12 12 12
```

Related Commands [show mls qos interface](#)

Chapter 54: 802.1X Configuration



Introduction.....	54.2
The 802.1X Implementation.....	54.2
Configuring 802.1X.....	54.2

Introduction

The IEEE Standard 802.1X provides a method of restricting access to networks based on authentication information. 802.1X provides port-based network access control for devices connected to the Ethernet. This allows a network controller to restrict external devices from gaining access to the network behind an 802.1X controlled port. External devices that wish to access services via a port under 802.1X control must firstly authenticate themselves and gain authorization before any packets originating from, or destined for, the external device are allowed to pass through the 802.1X controlled port.

The 802.1X Implementation

802.1X port access control is achieved by making devices attached to a controlled port authenticate themselves via communication with an authentication server before these devices are allowed to access the network behind the controlled port.

Authentication is required on a per-port basis. The main components of an 802.1X implementation are:

- the authenticator - the port on this device that wishes to enforce authentication before allowing access to services that are accessible behind it.
- the supplicant - the port that wishes to access services offered by the authenticator's system. The supplicant may be a port on a PC or other device connected to this device.
- the authentication server - a device that uses the authentication credentials supplied by the supplicant, via the authenticator, to determine if the authenticator should grant access to its services.

Configuring 802.1X

The following example explains how to configure 802.1X. In this example, the RADIUS Server keeps the Client information, validating the identity of the Client and updating the switch about the authentication status of the client. The switch is the physical access between the two clients and the server. It requests information from the client, relays information to the server and then back to the client.

To configure 802.1X authentication, first enable authentication on port1.0.1 and port1.0.2 and then specify the RADIUS Server IP address and port.

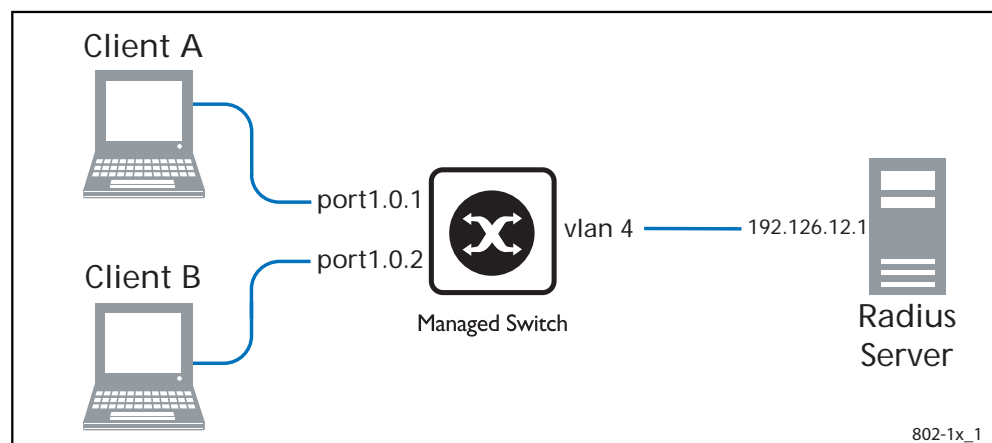

Table 54-1: 802.1X configuration on the switch

<code>awplus# configure terminal</code>	Enter the Global Configuration mode.
<code>awplus(config)# aaa authentication dot1x default group radius</code>	Enable authentication globally.
<code>awplus(config)# interface port1.0.1</code>	Specify the interface (<code>port1.0.1</code>) to be configured and enter the Interface mode.
<code>awplus(config-if)# dot1x port-control auto</code>	Enable authentication (via RADIUS) on <code>port1.0.1</code> .
<code>awplus(config-if)# dot1x control-direction both</code>	Block traffic in both directions, other than authentication packets, until authentication is complete.
<code>awplus(config-if)# exit</code>	Exit the Interface Configuration mode and enter the Global Configuration mode.
<code>awplus(config)# interface port1.0.2</code>	Specify the interface (<code>port1.0.2</code>) you are configuring and enter the Interface mode.
<code>awplus(config-if)# dot1x port-control auto</code>	Enable authentication (via Radius) on <code>port1.0.2</code> .
<code>awplus(config-if)# exit</code>	Exit the Interface Configuration mode and enter the Global Configuration mode.
<code>awplus(config)# radius-server host 192.126.12.1 auth-port 1812</code>	Specify the Radius Server address (<code>192.126.12.1</code>) and authentication port.
<code>awplus(config)# radius-server key secret</code>	Specify the shared key <code>secret</code> between the radius server and the client.
<code>awplus(config)# interface vlan4</code>	Specify the vlan (<code>vlan4</code>) to be configured and enter the Interface mode.
<code>awplus(config-if)# ip address 192.126.12.2/24</code>	Set the IP address on <code>vlan4</code> .

Names of Commands Used

`dot1x port-control`
`radius-server host`
`radius-server key`

Validation Commands

`show dot1x`
`show dot1x interface`

Chapter 55: 802.1X Commands



Command List	55.2
debug dot1x	55.2
dot1x control-direction	55.3
dot1x eap	55.4
dot1x eapol-version	55.5
dot1x initialize interface	55.6
dot1x keytransmit	55.7
dot1x max-auth-fail	55.8
dot1x max-reauth-req	55.9
dot1x port-control	55.10
dot1x timeout tx-period	55.11
show debugging dot1x	55.12
show dot1x	55.13
show dot1x diagnostics	55.15
show dot1x interface	55.16
show dot1x sessionstatistics	55.21
show dot1x statistics interface	55.22
show dot1x supplicant	55.23
show dot1x supplicant interface	55.25
undebug dot1x	55.26

Command List

This chapter provides an alphabetical reference of commands used to configure 802.1X port access control. For more information, see [Chapter 54, 802.1X Configuration](#).

debug dot1x

Use this command to enable 802.1X IEEE Port-Based Network Access Control troubleshooting functions.

Use the **no** variant of this command to disable this function.

Syntax `debug dot1x [all|auth-web|event|nsm|packet|timer]`
`no debug all dot1x`
`no debug dot1x [all|auth-web|event|nsm|packet|timer]`

Parameter	Description
all	Used with the no variant of this command exclusively; turns off all debugging for 802.1X.
auth-web	Specifies debugging for 802.1X auth-web information.
events	Specifies debugging for 802.1X events.
nsm	Specifies debugging for NSM messages.
packet	Specifies debugging for 802.1X packets.
timer	Specifies debugging for 802.1X timers.

Mode Privileged Exec and Global Configuration

Usage This command without any parameters turns on normal 802.1X debug information.

```
awplus# debug dot1x
```

```
awplus# show debugging dot1x
```

```
802.1X debugging status:
 802.1X events debugging is
 802.1X timer debugging is on
 802.1X packets debugging is on
 802.1X NSM debugging is on
```

Examples

```
awplus# debug dot1x
```

```
awplus# debug dot1x all
```

Related Commands [show debugging dot1x](#)
[undebug dot1x](#)

dot1x control-direction

This command sets the direction of the filter for the unauthorized interface.

If the optional **in** parameter is specified with this command then packets entering the specified port are discarded. The **in** parameter discards the ingress packets received from the supplicant.

If the optional **both** parameter is specified with this command then packets entering (ingress) and leaving (egress) the specified port are discarded. The **both** parameter discards the packets received from the supplicant and sent to the supplicant.

The **no** variant of this command sets the direction of the filter to **both**. The port will then discard both ingress and egress traffic.

Syntax `dot1x control-direction {in|both}`
`no dot1x control-direction`

Parameter	Description
<code>in</code>	Discard received packets from the supplicant (ingress packets).
<code>both</code>	Discard received packets from the supplicant (ingress packets) and transmitted packets to the supplicant (egress packets).

Default The authentication port direction is set to **both** by default.

Mode Interface Configuration for a static channel, a dynamic (LACP) channel group, or a switch port.

Example To set the port direction to the default (**both**) for `port1.0.2`, use the following commands:

```
awplus# configure terminal
awplus(config)# interface port1.0.2
awplus(config-if)# no dot1x control-direction
```

To set the port direction to **in** for `port1.0.2`, use the following commands:

```
awplus# configure terminal
awplus(config)# interface port1.0.2
awplus(config-if)# dot1x control-direction in
```

Validation Commands [show dot1x](#)
[show dot1x interface](#)
[show auth-mac interface](#)
[show auth-web interface](#)

dot1x eap

This command selects the transmit mode for the EAP packet. If the authentication feature is not enabled then EAP transmit mode is not enabled. The default setting discards EAP packets.

Syntax `dot1x eap {discard|forward|forward-untagged-vlan|forward-vlan}`

Parameter	Description
<code>discard</code>	Discard.
<code>forward</code>	Forward to all ports on the switch.
<code>forward-untagged-vlan</code>	Forward to ports with the same untagged VLAN.
<code>forward-vlan</code>	Forward to ports with the same VLAN.

Default The transmit mode is set to `discard` EAP packets by default.

Mode Global Configuration

Example To set the transmit mode of EAP packet to `forward` to forward EAP packets to all ports on the switch, use the following commands:

```
awplus# configure terminal
awplus(config)# dot1x eap forward
```

To set the transmit mode of EAP packet to `discard` to discard EAP packets, use the following commands:

```
awplus# configure terminal
awplus(config)# dot1x eap discard
```

To set the transmit mode of EAP packet to `forward-untagged-vlan` to forward EAP packets to ports with the same untagged vlan, use the following commands:

```
awplus# configure terminal
awplus(config)# dot1x eap forward-untagged-vlan
```

To set the transmit mode of EAP packet to `forward-vlan` to forward EAP packets to ports with the same vlan, use the following commands:

```
awplus# configure terminal
awplus(config)# dot1x eap forward-vlan
```

dot1x eapol-version

This command sets the EAPOL protocol version for EAP packets when 802.1X port authentication is applied.

Use the **no** variant of this command to set the EAPOL protocol version to 1.

The default EAPOL protocol version is version 1.

Syntax `dot1x eapol-version {1|2}`
`no dot1x eapol-version`

Parameter	Description
1	EAPOL version.
2	EAPOL version.

Default The EAP version for 802.1X authentication is set to 1 by default.

Mode Interface Configuration for a static channel, a dynamic (LACP) channel group, or a switch port.

Example To set the EAPOL protocol version to 2 for `port1.0.2`, use the following commands:

```
awplus# configure terminal
awplus(config)# interface port1.0.2
awplus(config-if)# dot1x eapol-version 2
```

To set the EAPOL protocol version to the default version (1) for interface `port1.0.2`, use the following commands:

```
awplus# configure terminal
awplus(config)# interface port1.0.2
awplus(config-if)# no dot1x eapol-version
```

Validation Commands `show dot1x`
`show dot1x interface`

dot1x initialize interface

This command initializes the 802.1X status on the specified interface, and attempts reauthentication.

Use this command to unauthorize a port, and attempt reauthentication on the specified interface, which may be a static channel (or static aggregator) or a dynamic (or LACP) channel group or a switch port.

Syntax `dot1x initialize interface <interface-list>`

Parameter	Description
<code><interface-list></code>	<p>The interfaces or ports to configure. An interface-list can be:</p> <ul style="list-style-type: none"> ■ an interface (e.g. <code>vlan2</code>), a switch port (e.g. <code>port1.1.12</code>), a static channel group (e.g. <code>sa3</code>) or a dynamic (LACP) channel group (e.g. <code>po4</code>) ■ a continuous range of interfaces, ports, static channel groups or dynamic (LACP) channel groups separated by a hyphen; e.g. <code>vlan2-8</code>, or <code>port1.1.1-1.1.24</code>, or <code>sa2-4</code>, or <code>po1-3</code> ■ a comma-separated list of the above; e.g. <code>port1.0.1,port1.1.1-1.2.24</code>. Do not mix interface types in a list. <p>The specified interfaces must exist.</p>

Mode Privileged Exec

Example To initialize 802.1X port authentication on the interface `port1.0.2`, use the following command:

```
awplus# dot1x initialize interface port1.0.12
```

To unauthorize switch port 1.0.1 and attempt reauthentication on switch `port1.0.1` enter:

```
awplus# dot1x initialize interface port1.0.1
```

To unauthorize all switch ports for a 24 switch port device and attempt reauthentication enter:

```
awplus# dot1x initialize interface port1.0.1-port1.0.24
```

dot1x keytransmit

This command enables key transmission on the interface specified previously in Interface mode. The **no** variant of this command disables key transmission on the interface specified.

Syntax dot1x keytransmit
no dot1x keytransmit

Default Key transmission for port authentication is enabled by default.

Mode Interface Configuration for a static channel, a dynamic (LACP) channel group, or a switch port.

Usage Use this command to enable key transmission over an Extensible Authentication Protocol (EAP) packet between the authenticator and supplicant. Use the **no** variant of this command to disable key transmission.

Example To enable the key transmit feature on interface `port1.0.2`, after it has been disabled by negation, use the following commands:

```
awplus# configure terminal
awplus(config)# interface port1.0.2
awplus(config-if)# dot1x keytransmit
```

To disable the key transmit feature from the default startup configuration on interface `port1.0.2`, use the following commands:

```
awplus# configure terminal
awplus(config)# interface port1.0.2
awplus(config-if)# no dot1x keytransmit
```

Validation show dot1x
Commands show dot1x interface

dot1x max-auth-fail

Use this command to configure the maximum number of login attempts for a supplicant (client device) using the **auth-fail vlan** feature, when using 802.1X port authentication on an interface.

The **no** variant of this command resets the maximum login attempts for a supplicant (client device) using the auth-fail vlan feature, to the default configuration of 3 login attempts.

Syntax `dot1x max-auth-fail <1-10>`

`no dot1x max-auth-fail`

Parameter	Description
<1-10>	Specify the maximum number of login attempts for supplicants on an interface using 802.1X port authentication.

Default The default maximum number of login attempts for a supplicant on an interface using 802.1X port authentication is three (3) login attempts.

Mode Interface Configuration for a static channel, a dynamic (LACP) channel group, or a switch port.

Usage This command sets the maximum number of login attempts for supplicants on an interface. The supplicant is moved to the auth-fail VLAN from the Guest VLAN after the number of failed login attempts using 802.1X authentication is equal to the number set with this command.

See the related [auth auth-fail vlan command on page 57.3](#). See also the section [“Failed authentication VLAN” on page 56.11](#) for information about the auth-fail VLAN feature.

See the section [“Limitations on allowed feature combinations” on page 56.12](#) for information about restrictions regarding combinations of authentication enhancements working together.

Examples To configure the maximum number of login attempts for a supplicant on interface `port1.0.2` to a single (1) login attempt, use the following commands:

```
awplus# configure terminal
awplus(config)# interface port1.0.2
awplus(config-if)# dot1x max-auth-fail 1
```

To configure the maximum number of login attempts for a supplicant on interface `port1.0.2` to the default number of three (3) login attempts, use the following commands:

```
awplus# configure terminal
awplus(config)# interface port1.0.2
awplus(config-if)# no dot1x max-auth-fail
```

Validation Commands `show running-config`

Related Commands `auth auth-fail vlan`
`dot1x max-reauth-req`
`show dot1x interface`

dot1x max-reauth-req

This command sets the number of reauthentication attempts before an interface is unauthorized.

The **no** variant of this command resets the reauthentication delay to the default.

Syntax `dot1x max-reauth-req <1-10>`

`no dot1x max-reauth-req`

Parameter	Description
<1-10>	Specify the maximum number of reauthentication attempts for supplicants on an interface using 802.1X port authentication.

Default The default maximum reauthentication attempts for interfaces using 802.1X port authentication is two (2) reauthentication attempts, before an interface is unauthorized.

Mode Interface Configuration for a static channel, a dynamic (LACP) channel group, or a switch port.

Usage Use this command to set the maximum reauthentication attempts after failure.

Examples To configure the maximum number of reauthentication attempts for interface `port1.0.2` to a single (1) reauthentication request, use the following commands:

```
awplus# configure terminal
awplus(config)# interface port1.0.2
awplus(config-if)# dot1x max-reauth-req 1
```

To configure the maximum number of reauthentication attempts for interface `port1.0.2` to the default maximum number of two (2) reauthentication attempts, use the following commands:

```
awplus# configure terminal
awplus(config)# interface port1.0.2
awplus(config-if)# no dot1x max-reauth-req
```

Validation Commands `show running-config`

Related Commands `dot1x max-auth-fail`
`show dot1x interface`

dot1x port-control

This command enables 802.1X port authentication on the interface specified, and sets the control of the authentication port. When **port-control** is set to **auto**, the 802.1X authentication feature is executed on the interface, but only if the **aaa authentication dot1x** command has been issued.

The **no** variant of this command disables the port authentication on the interface specified.

Syntax `dot1x port-control {force-unauthorized|force-authorized|auto}`
`no dot1x port-control`

Parameter	Description
<code>force-unauthorized</code>	Force port state to unauthorized. Specify to force a port to always be in an unauthorized state.
<code>force-authorized</code>	Force port state to authorized. Specify to force a port to always be in an authorized state.
<code>auto</code>	Allow port client to negotiate authentication. Specify to enable authentication on port.

Default 802.1X port control is disabled by default.

Mode Interface Configuration for a static channel, a dynamic (LACP) channel group, or a switch port.

Usage Use this command to force a port state. Note that all **dot1x** commands can only be applied to switch ports. They cannot be applied to dynamic (LACP) or static channel groups.

Example To enable port authentication on the interface `port1.0.2`, use the following commands:

```
awplus# configure terminal
awplus(config)# interface port1.0.2
awplus(config-if)# dot1x port-control auto
```

To enable port authentication force authorized on the interface `port1.0.2`, use the following commands:

```
awplus# configure terminal
awplus(config)# interface port1.0.2
awplus(config-if)# dot1x port-control force-authorized
```

To disable port authentication on the interface `port1.0.2`, use the following commands:

```
awplus# configure terminal
awplus(config)# interface port1.0.2
awplus(config-if)# no dot1x port-control
```

Validation Commands `show dot1x interface`

Related Commands `aaa authentication dot1x`

dot1x timeout tx-period

This command sets the transmit timeout for the authentication request on the specified interface.

The **no** variant of this command resets the transmit timeout period to the default (30 seconds).

Syntax `dot1x timeout tx-period <1-65535>`
`no dot1x timeout tx-period`

Parameter	Description
<code><1-65535></code>	Seconds.

Default The default transmit period for port authentication is 30 seconds.

Mode Interface Configuration for a static channel, a dynamic (LACP) channel group, or a switch port.

Usage Use this command to set the interval between successive attempts to request an ID.

Example To set the transmit timeout period to 5 seconds on interface `port1.0.2`, use the below commands:

```
awplus# configure terminal
awplus(config)# interface port1.0.2
awplus(config-if)# dot1x timeout tx-period 5
```

To reset transmit timeout period to the default (30 seconds) on interface `port 1.0.2`, use the following commands:

```
awplus# configure terminal
awplus(config)# interface port1.0.2
awplus(config-if)# no dot1x timeout tx-period
```

Validation Commands `show dot1x`
`show dot1x interface`

show debugging dot1x

Use this command to display the 802.1X debugging option set.

For information on output options, see [“Controlling “show” Command Output” on page 1.35.](#)

Syntax `show debugging dot1x`

Mode Privileged Exec

Usage This is a sample output from the `show debugging dot1x` command.

```
awplus# debug dot1x
```

```
awplus# show debugging dot1x
```

```
802.1X debugging status:
 802.1X events debugging is on
 802.1X timer debugging is on
 802.1X packets debugging is on
 802.1X NSM debugging is on
```

Example

```
awplus# show debugging dot1x
```

Related Commands [debug dot1x](#)

show dot1x

This command shows authentication information for dot1x (802.1X) port authentication.

If you specify the optional **all** parameter then this command also displays all authentication information for each port available on the switch.

For information on output options, see ["Controlling "show" Command Output" on page 1.35.](#)

Syntax `show dot1x [all]`

Parameter	Description
all	All.

Mode User Exec and Privileged Exec

Example

```
awplus# show dot1x all
```

Table 55-1: Example output from the **show dot1x** command

```
awplus# show dot1x all
802.1X Port-Based Authentication Enabled
RADIUS server address: 150.87.18.89:1812
Next radius message id: 5
RADIUS client address: not configured
Authentication info for interface port1.0.12
portEnabled: true - portControl: Auto
portStatus: Authorized
reAuthenticate: disabled
reAuthPeriod: 3600
PAE: quietPeriod: 60 - maxReauthReq: 2 - txPeriod: 30
BE: suppTimeout: 30 - serverTimeout: 30
CD: adminControlledDirections: in
KT: keyTxEnabled: false
critical: disabled
guestVlan: disabled
dynamicVlanCreation: single-dynamic-vlan
    assignFailActionRule: deny
hostMode: multi-supPLICANT
    maxSupPLICANT: 1024
dot1x: enabled
    protocolVersion: 1
authMac: enabled
    method: PAP
    reauthRelearning: disabled
authWeb: enabled
    method: PAP
    lockCount: 3
    packetForwarding: disabled
```

Table 55-1: Example output from the **show dot1x** command (cont.)

```

supplicantMac: none
Supplicant name: manager
Supplicant address: 00d0.59ab.7037
  authenticationMethod: 802.1X Authentication
  portStatus: Authorized - currentId: 1
  abort:F fail:F start:F timeout:F success:T
  PAE: state: Authenticated - portMode: Auto
  PAE: reAuthCount: 0 - rxRespId: 0
  PAE: quietPeriod: 60 - maxReauthReq: 2 - txPeriod: 30
  BE: state: Idle - reqCount: 0 - idFromServer: 0
  CD: adminControlledDirections: in - operControlledDirections: in
  CD: bridgeDetected: false
  KR: rxKey: false
  KT: keyAvailable: false - keyTxEnabled: false
  criticalState: off
  dynamicVlanId: 2
802.1X statistics for interface port1.0.12
  EAPOL Frames Rx: 5 - EAPOL Frames Tx: 16
  EAPOL Start Frames Rx: 0 - EAPOL Logoff Frames Rx: 0
  EAP Rsp/Id Frames Rx: 3 - EAP Response Frames Rx: 2
  EAP Req/Id Frames Tx: 8 - EAP Request Frames Tx: 2
  Invalid EAPOL Frames Rx: 0 - EAP Length Error Frames Rx: 0
  EAPOL Last Frame Version Rx: 1 - EAPOL Last Frame Src: 00d0.59ab.7037
Authentication session statistics for interface port1.0.12
  session user name: manager
  session authentication method: Remote server
  session time: 19440 secs
  session terminate cause: Not terminated yet
Authentication Diagnostics for interface port1.0.12
  Supplicant address: 00d0.59ab.7037
  authEnterConnecting: 2
  authEaplogoffWhileConnecting: 1
  authEnterAuthenticating: 2
  authSuccessWhileAuthenticating: 1
  authTimeoutWhileAuthenticating: 1
  authFailWhileAuthenticating: 0
  authEapstartWhileAuthenticating: 0
  authEaplogoggWhileAuthenticating: 0
  authReauthsWhileAuthenticated: 0
  authEapstartWhileAuthenticated: 0
  authEaplogoffWhileAuthenticated: 0
  BackendResponses: 2
  BackendAccessChallenges: 1
  BackendOtherrequestToSupplicant: 3
  BackendAuthSuccess: 1
  BackendAuthFails: 0

```

show dot1x diagnostics

This command shows 802.1X authentication diagnostics for the specified interface (optional), which may be a static channel (or static aggregator) or a dynamic (or LACP) channel group or a switch port.

If no interface is specified then authentication diagnostics are shown for all interfaces.

For information on output options, see ["Controlling "show" Command Output" on page 1.35.](#)

Syntax `show dot1x diagnostics [interface <interface-list>]`

Parameter	Description
<code>interface</code>	Specify a port to show.
<code><interface-list></code>	<p>The interfaces or ports to configure. An interface-list can be:</p> <ul style="list-style-type: none"> ■ an interface (e.g. <code>vlan2</code>), a switch port (e.g. <code>port1.1.12</code>), a static channel group (e.g. <code>sa3</code>) or a dynamic (LACP) channel group (e.g. <code>po4</code>) ■ a continuous range of interfaces, ports, static channel groups or dynamic (LACP) channel groups separated by a hyphen; e.g. <code>vlan2-8</code>, or <code>port1.1.1-1.1.24</code>, or <code>sa2-4</code>, or <code>po1-3</code> ■ a comma-separated list of the above; e.g. <code>port1.0.1, port1.1.1-1.2.24</code>. Do not mix interface types in a list. <p>The specified interfaces must exist.</p>

Mode User Exec and Privileged Exec

Example See the sample output below showing 802.1X authentication diagnostics for port 1.0.12:

```
awplus# show dot1x diagnostics interface port1.0.12
```

Output Figure 55-1: Example output from the `show dot1x diagnostics` command

```
Authentication Diagnostics for interface port1.0.12
  Supplicant address: 00d0.59ab.7037
    authEnterConnecting: 2
    authEaplogoffWhileConnecting: 1
    authEnterAuthenticating: 2
    authSuccessWhileAuthenticating: 1
    authTimeoutWhileAuthenticating: 1
    authFailWhileAuthenticating: 0
    authEapstartWhileAuthenticating: 0
    authEaplogoggWhileAuthenticating: 0
    authReauthsWhileAuthenticated: 0
    authEapstartWhileAuthenticated: 0
    authEaplogoffWhileAuthenticated: 0
  BackendResponses: 2
  BackendAccessChallenges: 1
  BackendOtherrequestToSupplicant: 3
  BackendAuthSuccess: 1
```

show dot1x interface

This command shows the status of 802.1X port-based authentication on the specified interface, which may be a static channel (or static aggregator) or a dynamic (or LACP) channel group or a switch port.

Use the optional **diagnostics** parameter to show authentication diagnostics for the specified interfaces. Use the optional **sessionstatistics** parameter to show authentication session statistics for the specified interfaces. Use the optional **statistics** parameter to show authentication diagnostics for the specified interfaces. Use the optional **supplicant** parameter to show the supplicant state for the specified interfaces.

For information on output options, see [“Controlling “show” Command Output” on page 1.35.](#)

Syntax `show dot1x interface <interface-list>
[diagnostics|sessionstatistics|statistics|supplicant [brief]]`

Parameter	Description
<code><interface-list></code>	<p>The interfaces or ports to configure. An interface-list can be:</p> <ul style="list-style-type: none"> ■ an interface (e.g. <code>vlan2</code>), a switch port (e.g. <code>port1.1.12</code>), a static channel group (e.g. <code>sa3</code>) or a dynamic (LACP) channel group (e.g. <code>po4</code>) ■ a continuous range of interfaces, ports, static channel groups or dynamic (LACP) channel groups separated by a hyphen; e.g. <code>vlan2-8</code>, or <code>port1.1.1-1.1.24</code>, or <code>sa2-4</code>, or <code>po1-3</code> ■ a comma-separated list of the above; e.g. <code>port1.0.1, port1.1.1-1.2.24</code>. Do not mix interface types in a list. <p>The specified interfaces must exist.</p>
<code>diagnostics</code>	Diagnostics.
<code>sessionstatistics</code>	Session Statistics.
<code>statistics</code>	Statistics.
<code>supplicant</code>	Supplicant.
<code>brief</code>	Brief summary of supplicant state.

Mode User Exec and Privileged Exec

Example See the sample output below showing 802.1X authentication status for port1.0.12:

```
awplus# show dot1x interface port1.0.12
```

Table 55-2: Example output from the **show dot1x interface** command for a port

```
awplus#show dot1x interface port1.0.12
Authentication info for interface port1.0.12
  portEnabled: true - portControl: Auto
  portStatus: Authorized
  reAuthenticate: disabled
  reAuthPeriod: 3600
  PAE: quietPeriod: 60 - maxReauthReq: 2 - txPeriod: 30
  BE: suppTimeout: 30 - serverTimeout: 30
  CD: adminControlledDirections: in
  KT: keyTxEnabled: false
  critical: disabled
  guestVlan: disabled
  dynamicVlanCreation: single-dynamic-vlan
    assignFailActionRule: deny
  hostMode: multi-supPLICANT
    maxSupPLICANT: 1024
  dot1x: enabled
    protocolVersion: 1
  authMac: enabled
    method: PAP
    reauthRelearning: disabled
  authWeb: enabled
    method: PAP
    lockCount: 3
    packetForwarding: disabled
  supPLICANTMac: none
```

See the sample output below showing 802.1X authentication session statistics for port1.0.12:

```
awplus# show dot1x interface port1.0.12 sessionstatistics
```

```
awplus#show dot1x interface port1.0.12 sessionstatistics
Authentication session statistics for interface port1.0.12
  session user name: manager
  session authentication method: Remote server
  session time: 19440 secs
  session terminat cause: Not terminated yet
```

See sample output below showing 802.1X authentication diagnostics for port1.0.12:

```
awplus# show dot1x interface port1.0.12 diagnostics
```

```
awplus#show dot1x interface port1.0.12 diagnostics
Authentication Diagnostics for interface port1.0.12
  Supplicant address: 00d0.59ab.7037
    authEnterConnecting: 2
    authEaplogoffWhileConnecting: 1
    authEnterAuthenticating: 2
    authSuccessWhileAuthenticating: 1
    authTimeoutWhileAuthenticating: 1
    authFailWhileAuthenticating: 0
    authEapstartWhileAuthenticating: 0
    authEaplogoggWhileAuthenticating: 0
    authReauthsWhileAuthenticated: 0
    authEapstartWhileAuthenticated: 0
    authEaplogoffWhileAuthenticated: 0
    BackendResponses: 2
    BackendAccessChallenges: 1
    BackendOtherrequestToSupplicant: 3
    BackendAuthSuccess: 1
```

See sample output below showing the supplicant on the interface port1.0.12:

```
awplus# show dot1x interface port1.0.12 supplicant
```

```
awplus#show dot1x interface port1.0.12 supplicant
authenticationMethod: dot1x
  totalSupplicantNum: 1
  authorizedSupplicantNum: 1
    macBasedAuthenticationSupplicantNum: 0
    dot1xAuthenticationSupplicantNum: 1
    webBasedAuthenticationSupplicantNum: 0
Supplicant name: manager
Supplicant address: 00d0.59ab.7037
  authenticationMethod: dot1x
  portStatus: Authorized - currentId: 4
  abort:F fail:F start:F timeout:F success:T
  PAE: state: Authenticated - portMode: Auto
  PAE: reAuthCount: 0 - rxRespId: 0
  PAE: quietPeriod: 60 - maxReauthReq: 2 - txPeriod: 30
  BE: state: Idle - reqCount: 0 - idFromServer: 3
  BE: suppTimeout: 30 - serverTimeout: 30
  CD: adminControlledDirections: in - operControlledDirections:
in
  CD: bridgeDetected: false
  KR: rxKey: false
  KT: keyAvailable: false - keyTxEnabled: false
```

See sample output below showing 802.1X (dot1x) authentication statistics for port1.0.12:

```
awplus# show dot1x statistics interface port1.0.12
```

```
awplus#show dot1x statistics interface port1.0.12
802.1X statistics for interface port1.0.12
EAPOL Frames Rx: 5 - EAPOL Frames Tx: 16
EAPOL Start Frames Rx: 0 - EAPOL Logoff Frames Rx: 0
EAP Rsp/Id Frames Rx: 3 - EAP Response Frames Rx: 2
EAP Req/Id Frames Tx: 8 - EAP Request Frames Tx: 2
Invalid EAPOL Frames Rx: 0 - EAP Length Error Frames Rx: 0
EAPOL Last Frame Version Rx: 1 - EAPOL Last Frame
Src:00d0.59ab.7037
```

Output

Table 55-3: Parameters in the output of the **show dot1x interface** command

Parameter	Description
portEnabled	Interface operational status (Up=true/down=false).
portControl	Current control status of the port for 802.1X control.
portStatus	802.1X status of the port (authorized/unauthorized).
reAuthenticate	Reauthentication enabled/disabled status on port.
reAuthPeriod	Value holds meaning only if reauthentication is enabled.
abort	Indicates that authentication should be aborted when set to true.
fail	Indicates failed authentication attempt when set to false.
start	Indicates authentication should be started when set to true.
timeout	Indicates authentication attempt timed out when set to true.
success	Indicates authentication successful when set to true.
state	Current 802.1X operational state of interface.
mode	Configured 802.1X mode.
reAuthCount	Reauthentication count.
quietperiod	Time between reauthentication attempts.
reAuthMax	Maximum reauthentication attempts.
BE	Backend authentication state machine variables and constants.
state	State of the state machine.
reqCount	Count of requests sent to server.
suppTimeout	Supplicant timeout.
serverTimeout	Server timeout.
maxReq	Maximum requests to be sent.
CD	Controlled Directions State machine.

Table 55-3: Parameters in the output of the **show dot1x interface** command (cont.)

Parameter	Description
adminControlledDirections	Administrative value (Both/In).
operControlledDirections	Operational Value (Both/In).
KR	Key receive state machine.
rxKey	True when EAPOL-Key message is received by supplicant or authenticator. false when key is transmitted.
KT	Ket Transmit State machine.
keyAvailable	False when key has been transmitted by authenticator, true when new key is available for key exchange.
keyTxEnabled	Key transmission enabled/disabled status.

Related Commands

- [show auth-web diagnostics](#)
- [show dot1x sessionstatistics](#)
- [show dot1x statistics interface](#)
- [show dot1x supplicant interface](#)

show dot1x sessionstatistics

This command shows authentication session statistics for the specified interface, which may be a static channel (or static aggregator) or a dynamic (or LACP) channel group or a switch port.

For information on output options, see [“Controlling “show” Command Output” on page 1.35.](#)

Syntax `show dot1x sessionstatistics [interface <interface-list>]`

Parameter	Description
interface	Specify a port to show.
<interface-list>	<p>The interfaces or ports to configure. An interface-list can be:</p> <ul style="list-style-type: none"> ■ an interface (e.g. <code>vlan2</code>), a switch port (e.g. <code>port1.1.12</code>), a static channel group (e.g. <code>sa3</code>) or a dynamic (LACP) channel group (e.g. <code>po4</code>) ■ a continuous range of interfaces, ports, static channel groups or dynamic (LACP) channel groups separated by a hyphen; e.g. <code>vlan2-8</code>, or <code>port1.1.1-1.1.24</code>, or <code>sa2-4</code>, or <code>po1-3</code> ■ a comma-separated list of the above; e.g. <code>port1.0.1,port1.1.1-1.2.24</code>. Do not mix interface types in a list. <p>The specified interfaces must exist.</p>

Mode User Exec and Privileged Exec

Example See sample output below showing 802.1X (`dot1x`) authentication session statistics for port 1.0.12:

```
awplus# show dot1x sessionstatistics interface port1.0.12
```

```
Authentication session statistics for interface port1.0.12
session user name: manager
session authentication method: Remote server
session time: 19440 secs
session terminat cause: Not terminated yet
```

show dot1x statistics interface

This command shows the authentication statistics for the specified interface, which may be a static channel (or static aggregator) or a dynamic (or LACP) channel group or a switch port.

For information on output options, see [“Controlling “show” Command Output” on page 1.35.](#)

Syntax `show dot1x statistics interface <interface-list>`

Parameter	Description
<code><interface-list></code>	<p>The interfaces or ports to configure. An interface-list can be:</p> <ul style="list-style-type: none"> ■ an interface (e.g. <code>vlan2</code>), a switch port (e.g. <code>port1.1.12</code>), a static channel group (e.g. <code>sa3</code>) or a dynamic (LACP) channel group (e.g. <code>po4</code>) ■ a continuous range of interfaces, ports, static channel groups or dynamic (LACP) channel groups separated by a hyphen; e.g. <code>vlan2-8</code>, or <code>port1.1.1-1.1.24</code>, or <code>sa2-4</code>, or <code>po1-3</code> ■ a comma-separated list of the above; e.g. <code>port1.0.1,port1.1.1-1.2.24</code>. Do not mix interface types in a list. <p>The specified interfaces must exist.</p>

Mode User Exec and Privileged Exec

Example See sample output below showing 802.1X authentication statistics for `port1.0.12`:

```
awplus# show dot1x statistics interface port1.0.12
```

```
802.1X statistics for interface port1.0.12
EAPOL Frames Rx: 5 - EAPOL Frames Tx: 16
EAPOL Start Frames Rx: 0 - EAPOL Logoff Frames Rx: 0
EAP Rsp/Id Frames Rx: 3 - EAP Response Frames Rx: 2
EAP Req/Id Frames Tx: 8 - EAP Request Frames Tx: 2
Invalid EAPOL Frames Rx: 0 - EAP Length Error Frames Rx: 0
EAPOL Last Frame Version Rx: 1 - EAPOL Last Frame
Src:00d0.59ab.7037
```

show dot1x supplicant

This command shows the supplicant state of the authentication mode set for the switch.

This command shows a summary when the optional **brief** parameter is used.

For information on output options, see [“Controlling “show” Command Output” on page 1.35.](#)

Syntax `show dot1x supplicant [<macadd>] [brief]`

Parameter	Description
<macadd>	MAC (hardware) address of the Supplicant.
brief	Brief summary of the Supplicant state.

Mode User Exec and Privileged Exec

Example See sample output below showing the 802.1X authenticated supplicant on the switch:

```
awplus# show dot1x supplicant
```

```
authenticationMethod: dot1x
totalSupplicantNum: 1
authorizedSupplicantNum: 1
macBasedAuthenticationSupplicantNum: 0
dot1xAuthenticationSupplicantNum: 1
webBasedAuthenticationSupplicantNum: 0
Supplicant name: manager
Supplicant address: 00d0.59ab.7037
  authenticationMethod: dot1x
  portStatus: Authorized - currentId: 4
  abort:F fail:F start:F timeout:F success:T
  PAE: state: Authenticated - portMode: Auto
  PAE: reAuthCount: 0 - rxRespId: 0
  PAE: quietPeriod: 60 - maxReauthReq: 2 - txPeriod: 30
  BE: state: Idle - reqCount: 0 - idFromServer: 3
  BE: suppTimeout: 30 - serverTimeout: 30
  CD: adminControlledDirections: in - operControlledDirections:
in
  CD: bridgeDetected: false
  KR: rxKey: false
  KT: keyAvailable: false - keyTxEnabled: false
```

See sample output below showing the supplicant on the switch using the `brief` parameter:

```
awplus# show dot1x supplicant 00d0.59ab.7037 brief
```

```
Interface port1.0.12
  authenticationMethod: dot1x
  totalSupplicantNum: 1
  authorizedSupplicantNum: 1
    macBasedAuthenticationSupplicantNum: 0
    dot1xAuthenticationSupplicantNum: 1
    webBasedAuthenticationSupplicantNum: 0
Interface VID Mode MAC Address Status IP Address Username
===== == == =====
port1.0.12 2 D 00d0.59ab.7037Authenticated 192.168.2.201 manager
```

Related Commands [show dot1x supplicant interface](#)

show dot1x supplicant interface

This command shows the supplicant state of the authentication mode set for the interface, which may be a static channel (or static aggregator) or a dynamic (or LACP) channel group or a switch port.

This command shows a summary when the optional **brief** parameter is used.

For information on output options, see ["Controlling "show" Command Output" on page 1.35.](#)

Syntax `show dot1x supplicant interface <interface-list> [brief]`

Parameter	Description
<code><interface-list></code>	<p>The interfaces or ports to configure. An interface-list can be:</p> <ul style="list-style-type: none"> ■ an interface (e.g. <code>vlan2</code>), a switch port (e.g. <code>port1.1.12</code>), a static channel group (e.g. <code>sa3</code>) or a dynamic (LACP) channel group (e.g. <code>po4</code>) ■ a continuous range of interfaces, ports, static channel groups or dynamic (LACP) channel groups separated by a hyphen; e.g. <code>vlan2-8</code>, or <code>port1.1.1-1.1.24</code>, or <code>sa2-4</code>, or <code>po1-3</code> ■ a comma-separated list of the above; e.g. <code>port1.0.1, port1.1.1-1.2.24</code>. Do not mix interface types in a list. <p>The specified interfaces must exist.</p>
<code>brief</code>	Brief summary of the Supplicant state.

Mode User Exec and Privileged Exec

Example See sample output below showing the supplicant on the interface `port1.0.19`:

```
awplus# show dot1x supplicant interface port1.0.19
```

```
Interface port1.0.19
authenticationMethod: dot1x
totalSupplicantNum: 1
authorizedSupplicantNum: 1
  macBasedAuthenticationSupplicantNum: 0
  dot1xAuthenticationSupplicantNum: 1
  webBasedAuthenticationSupplicantNum: 0
  otherAuthenticationSupplicantNum: 0

Supplicant name: VCSPCVLAN10
Supplicant address: 0000.cd07.7b60
authenticationMethod: 802.1X
portStatus: Authorized - currentId: 3
abort:F fail:F start:F timeout:F success:T
PAE: state: Authenticated - portMode: Auto
PAE: reAuthCount: 0 - rxRespId: 0
PAE: quietPeriod: 60 - maxReauthReq: 2
BE: state: Idle - reqCount: 0 - idFromServer: 2
CD: adminControlledDirections:in - operControlledDirections:in
CD: bridgeDetected: false
KR: rxKey: false
KT: keyAvailable: false - keyTxEnabled: false
```

See sample output below showing the supplicant on the switch using the `brief` parameter:

```
awplus# show dot1x supplicant interface brief
```

```
Interface port1.0.12
  authenticationMethod: dot1x
  totalSupplicantNum: 1
  authorizedSupplicantNum: 1
    macBasedAuthenticationSupplicantNum: 0
    dot1xAuthenticationSupplicantNum: 1
    webBasedAuthenticationSupplicantNum: 0

Interface VID Mode MAC Address      Status          IP Address      Username
===== === =====
port1.0.12 2   D   00d0.59ab.7037 Authenticated  192.168.2.201  manager
```

See the sample output below for static channel group (static aggregator) interface `sa1`:

```
awplus# show dot1x interface sa1 supplicant brief
```

```
awplus#show dot1x interface sa1 supplicant brief
Interface sa1
  authenticationMethod: dot1x
  totalSupplicantNum: 1
  authorizedSupplicantNum: 1
    macBasedAuthenticationSupplicantNum: 0
    dot1xAuthenticationSupplicantNum: 1
    webBasedAuthenticationSupplicantNum: 0
    otherAuthenticationSupplicantNum: 0

Interface  VID  Mode  MAC Address      Status          IP Address      Username
=====  ==  ==  =====
sa1         1   D    00d0.59ab.7037  Authenticated  --              test1
```

Related Commands [show dot1x supplicant](#)

undebug dot1x

This command applies the functionality of the [no debug dot1x command on page 55.2](#).

Chapter 56: Authentication Configuration



Authentication Introduction	56.2
Tri-Authentication Introduction	56.2
Tri-Authentication Configuration	56.2
Configuring a Guest VLAN	56.3
Roaming Authentication	56.4
Roaming Authentication Overview	56.5
Roaming Authentication Feature Interactions	56.6
Unauthenticated Supplicant Traffic	56.6
Deciding when a supplicant fails authentication	56.8
Authentication Enhancements	56.9
Web-authentication Enhancements	56.9
Guest VLAN Enhancements	56.10
Failed authentication VLAN	56.11
Limitations on allowed feature combinations	56.12

Authentication Introduction

Authentication commands enable you to specify three different types of device authentication: 802.1X authentication, MAC authentication, and Web-authentication. These are collectively called tri-authentication when applied to authenticate any devices connected to switch ports.

Tri-Authentication Introduction

The switch supports three types of authentication for devices that connect to switch ports:

- 802.1X authentication of devices connecting to switch ports
- MAC authentication of devices connecting to switch ports
- Web-authentication of devices connecting to switch ports

All three types can be configured to run simultaneously on a switch port. The simultaneous configuration and authentication of all three types on a port is called tri-authentication.

Tri-Authentication Configuration

Follow the below three steps to configure tri-authentication across a range of switch ports:

Step 1: Define the RADIUS Server:

Define the RADIUS Server where the switch will send authentication requests using the below commands:

```
awplus# configure terminal
awplus(config)# radius-server host <ip-address> key <key-string>
```

These commands add the RADIUS Server address and set parameters to the RADIUS server. The key parameter specifies the secret key for the server.



Note The RADIUS Server, where the switch sends authentication requests, could be the switch's own Local RADIUS Server. For information on how to configure Local RADIUS Server see [Chapter 62, Local RADIUS Server Introduction and Configuration](#).

Step 2: Define the default authentication server lists:

Define the default authentication server lists for 802.1X authentication, Web-based authentication, and MAC-based authentication:

```
awplus# configure terminal
awplus(config)# aaa authentication dot1x default group radius
awplus(config)# aaa authentication auth-web default group radius
awplus(config)# aaa authentication auth-mac default group radius
```

Step 3: Configure 802.1X, Web-based, and MAC-based authentication:

Configure 802.1X authentication, Web-authentication, MAC-authentication on switch ports to attach supplicant devices:

```
awplus# configure terminal
awplus(config)# interface <interface-range>
awplus(config-if)# switchport mode access
awplus(config-if)# switchport access vlan 1
awplus(config-if)# auth-web enable
awplus(config-if)# auth-mac enable
awplus(config-if)# dot1x port-control auto
awplus(config-if)# auth dynamic-vlan-creation
```

Configuring a Guest VLAN

You can configure 802.1X to accept a Dynamic VLAN assignment, or fall back to a Guest VLAN upon failure.

If 802.1X authentication has been configured on access ports in the network, you might still want to provide limited network access to those users whose devices do not have 802.1x supplicant enabled, or who have unrecognized authentication credentials.

The mechanism to achieve this is known as a guest VLAN. The idea is that if the users device fails 802.1X authentication, or is not even performing any 802.1X authentication, then its connection port can be put into the Guest VLAN.

To configure a switch to perform 802.1x authentication, and assign VLAN IDs to ports where devices authentication successfully, and put non-authenticated users into a Guest VLAN, proceed as follows:

```
awplus# configure terminal
awplus(config)# radius-server host <ip-address> key <key-string>
awplus(config)# aaa authentication dot1x default group radius
awplus(config)# interface <interface-range>
awplus(config-if)# switchport mode access
awplus(config-if)# dot1x port-control auto
awplus(config-if)# auth dynamic-vlan-creation
awplus(config-if)# auth guest-vlan 100
```

Roaming Authentication

When network security is required, the usability of network security must be considered. The Roaming Authentication feature improves the usability of network security by enabling users to move within the network without requiring them to re-authenticate each time they move.

If a supplicant (client device) moves from one wireless access point to another wireless access point, and the wireless access points are connected to different ports, then the switch (authenticator) recognizes that the supplicant has been authenticated and accepts the supplicant without requiring re-authentication.

Figure 56-1: Diagram showing **Roaming Authentication** running on a standalone switch

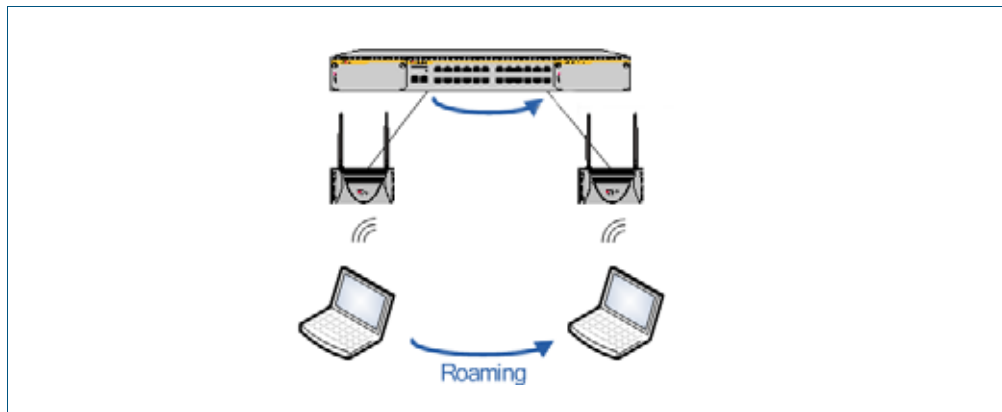

Web and MAC authentication are the authentication methods in a Wireless LAN environment, and 802.1X is the authentication method used for supplicants attached to edge switches.

Roaming Authentication is normally enabled using the [auth roaming enable command on page 57.16](#) command. However, Roaming Authentication has been extended (with the [auth roaming disconnected command on page 57.14](#)) to work where an interface is link down. This allows you to enable supplicants to move from authenticated interfaces that are link down, without requiring re-authentication. Roaming Authentication is available for use with the VCStack feature, and is available on static and dynamic (LACP) channel group interfaces.

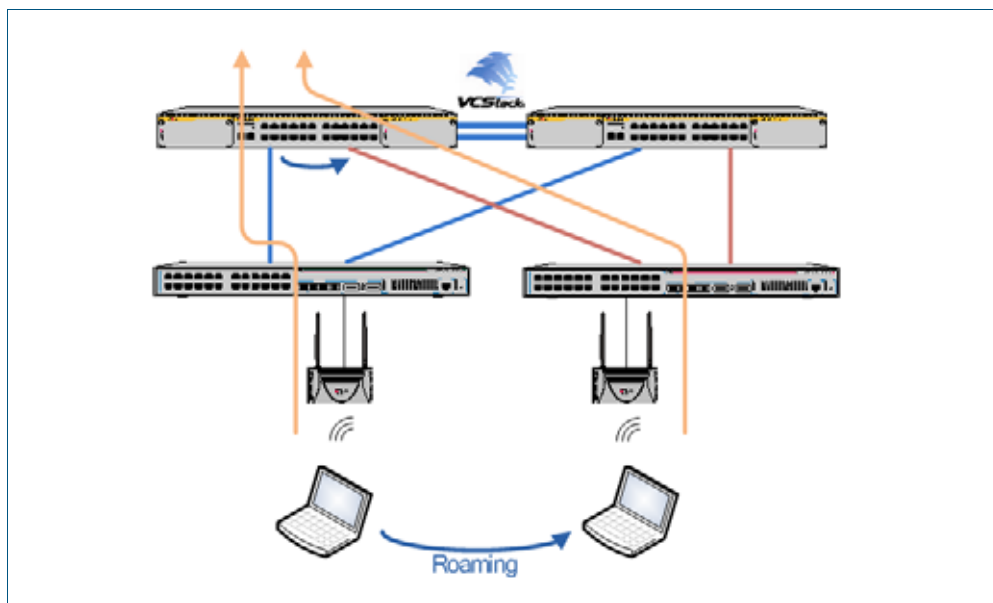
Figure 56-2: Diagram showing **Roaming Authentication** running with VCStack

Roaming Authentication Overview

Without the Roaming Authentication feature enabled, if a supplicant moves from one switch port to another switch port, the supplicant's authenticated status, authentication, and assigned VLAN is deleted and the supplicant is re-authenticated so the supplicant can access the network, and all traffic from the supplicant is dropped while the supplicant is being re-authenticated.

With the Roaming Authentication feature enabled, a switch port inherits the status of a supplicant from the switch port that the supplicant was moved from. If the Roaming Authentication feature is enabled on a switch, then once a supplicant (client device) is authenticated on the switch it does not have to be re-authenticated if it moves between ports of that switch. Supplicant traffic is not dropped because there is no delay for re-authentication, during which the supplicant cannot access the network.

For example, when the Roaming Authentication feature is used in a wireless LAN environment with wireless access points, then the wireless clients can roam between wireless access points connected to different switch ports without re-authentication.

The Roaming Authentication feature also supports VCStack operation and works on defined static channel group (static aggregators) and dynamic channel group (LACP) interfaces. When VCStack and Roaming Authentication features are used together, the status of a supplicant is inherited from one aggregated interface to another aggregated interface over the stack.

See the [auth roaming disconnected command on page 57.14](#) and the [auth roaming enable command on page 57.16](#) for further information about configuring Roaming Authentication.

Roaming Authentication Feature Interactions

When the Roaming Authentication feature is disabled, a supplicant must be re-authenticated on the destination interface when it roams. When the Roaming Authentication is enabled, the following supplicant authentication status and information is inherited from the source interface:

- Authentication status
- Authentication method
- Supplicant MAC address
- Supplicant IP address
(if an authenticated interface is configured for Web authentication)
- Supplicant name
- Authorized dynamic VLAN ID
- Authorized RADIUS server
- Reauthentication timer
(if configured using the [auth timeout reauth-period command on page 57.21](#))

Roaming Authentication is only supported between interfaces with the same authentication configuration. If source and destination interfaces have different authentication configuration then the supplicant will be re-authenticated at the destination interface.

When the host mode is set with the [auth host-mode command on page 57.10](#), a supplicant is not authenticated on a destination interface, and the authentication status is deleted on the source interface.

When a supplicant moves from an interface with authentication configured to an interface without authentication configured, the supplicant's authentication status is deleted.

A supplicant is re-authenticated when it moves to a destination interface that is configured on a different VLAN than the VLAN that is configured for the source interface.

See the below Roaming Authentication feature interactions on x900 and x908 series switches:

- The Roaming Authentication feature will not function with Dynamic VLANs.
- The Roaming Authentication feature will not function with Guest VLANs.

When the Roaming Authentication feature is configured for use on a stack with the VCStack feature, note that supplicants are initialized and re-authenticated if a VCStack fail over occurs.

Unauthenticated Supplicant Traffic

When any authentication is configured on a switch port, the question arises as to what the switch does with packets that arrive into the switch port from unauthenticated supplicants.

Unauthenticated supplicants fall into three categories listed below:

- Newly attached supplicants, which are still in the process of their first authentication attempt
- Supplicants that have made an authentication attempt, but have failed authentication
- Supplicants that have been attached, but have not made an authentication attempt. For example, on a port that has only 802.1x authentication enabled, any supplicant that has no 802.1x client software will not be able to attempt 802.1x authentication.

In switches that are running the AlliedWare Plus™ Operating System, packets from all these three categories of unauthenticated supplicants are treated equally; no distinction is made between these three categories. The treatment of the traffic from unauthenticated supplicants does, however, depend on two factors:

- Whether a Guest VLAN has been configured on the switch port to which the supplicant is attached
- Whether Web authentication has been configured on the switch port to which the supplicant is attached

The rules governing the treatment of packets from unauthenticated supplicants are laid out in the table below:

Switch port configuration	No Guest VLAN configured	Guest VLAN configured
Web authentication configured	<p>Packets from unauthenticated supplicants are associated with the Native VLAN of the port. Packets from unauthenticated supplicants are processed according these rules:</p> <ul style="list-style-type: none"> ■ Packets destined to the WebAuth server IP address/TCP port are forwarded to the server (which may well be the switch itself). ■ DHCP packets are sent to the CPU, to be processed by a local DHCP server, or relayed to another DHCP server, depending on the configuration of the switch. ■ DNS packets are forwarded to the CPU, and then sent on to a DNS server, if the switch is configured with a DNS server address. ■ ARP packets are forwarded to the CPU, and an ARP entry for the supplicant is learnt. ■ If web-auth forwarding is enabled for particular types of packets, then those packets will be forwarded within the Native VLAN ■ All other packets are dropped. 	<p>Packets from unauthenticated supplicants are associated with the Guest VLAN of the port. Packets from unauthenticated supplicants are processed according to these rules:</p> <ul style="list-style-type: none"> ■ Packets destined to the WebAuth server IP address/TCP port are forwarded to the server (which may well be the switch itself). ■ DHCP packets are sent to the CPU, to be processed by a local DHCP server, or relayed to another DHCP server, depending on the configuration of the switch. ■ DNS packets are forwarded to the CPU, and then sent on to a DNS server, if the switch is configured with a DNS server address. ■ ARP packets are forwarded to the CPU, and an ARP entry for the supplicant is learnt. ■ Drop all other packets destined to the IP address of the Guest VLAN. ■ Layer-2 forward packets destined to other addresses within the Guest VLAN. ■ All other packets are dropped.
No Web authentication configured	<p>All non-eap packets from unauthenticated supplicants are dropped.</p>	<p>Packets from unauthenticated supplicants are associated with the Guest VLAN of the port. The packets are processed according to these rules:</p> <ul style="list-style-type: none"> ■ Drop packets destined to the IP address of the Guest VLAN. ■ Layer-2 forward packets destined to other addresses within the Guest VLAN. ■ Drop all other packets.

Deciding when a supplicant fails authentication

Although the treatment of packets from unauthenticated supplicants does not differentiate between the three categories of supplicant, it is still useful to know for sure when the switch decides that a supplicant has failed authentication.

The rules for deciding that a supplicant has failed authentication are listed below for each type of authentication available:

Deciding when a supplicant fails 802.1X authentication

If the supplicant responds to EAP authentication requests, and the supplicant's authentication information is sent to the RADIUS server, and the RADIUS server replies with an Authentication-Reject, then the supplicant is immediately deemed to have failed authentication.

If the supplicant does not respond to EAP authentication requests, then the switch will resend the authentication requests up to a maximum number of attempts set by the command `dot1x max-reauth-req` (the default is 2). The interval between the attempts is set by the command `dot1x timeout tx-period` (the default is 30 seconds). If the supplicant still has not responded after this, it is deemed to have not attempted authentication.

See [Chapter 55, 802.1X Commands](#) for 802.1X authentication command information.

Deciding when a supplicant fails Web authentication

As soon as the supplicant attempts any web-browsing, the switch will intercept the web session, and present the supplicant with an authentication request page. If the user enters a username and password, and clicks the login button, then the switch will send the username and password to the RADIUS server. If the RADIUS server replies with an Authentication-Reject, then the supplicant is immediately deemed to have failed authentication.

Until the supplicant has attempted any web-browsing, or has received the authentication request page, but not yet clicked the login button, the supplicant is deemed to be not yet authenticated (as against not able to authenticate).

See [Chapter 57, Authentication Commands](#) for Web authentication command information.

Deciding when a supplicant fails MAC authentication

As soon as the supplicant sends any packet, the source MAC address from the packet will be sent to the RADIUS server for authentication. If the RADIUS server replies with an Authentication-Reject, then the supplicant is immediately deemed to have failed authentication.

With MAC auth there really is no concept of not-yet-attempted authentication, because authentication is attempted as soon as a supplicant sends a packet.

See [Chapter 57, Authentication Commands](#) for MAC authentication command information.

Authentication Enhancements

The authentication enhancements introduced in this release fall into three areas:

- **Web-authentication Enhancements**
Improvements to Web-authentication
- **Guest VLAN Enhancements**
Increased flexibility in the operation of the Guest VLAN
- **Failed authentication VLAN**
Introduction of the auth-fail VLAN

See the section [“Limitations on allowed feature combinations” on page 56.12](#) for information about restrictions regarding combinations of authentication enhancements working together.

Web-authentication Enhancements

Web-authentication can now operate as seamlessly as 802.1X authentication.

In previous releases there were limitations in the operation of Web-authentication. In particular, the authenticating switch had to be the default gateway for the client PC, or the user on the client PC had to browse explicitly to the IP address of the switch. As a result, previous web-authentication would not reliably interoperate with a client PC that had static IP configuration.

The aim of the enhancements in this release is to ensure that the client PC user is presented with the Web-authentication login page as soon as they start web browsing to **any** address, irrespective of the IP configuration (whether or not it is static or dynamic) on their client PC.

There are three aspects to the enhancements that have been implemented in order to do this:

- **DHCP Server for Web-authentication**
- **Interception of clients' ARPs**
- **Proxy DNS response**

DHCP Server for Web-authentication

In previous releases, a DHCP service could be configured on the authenticating switch, serving IP addresses in the subnet used on the Guest VLAN. While this did facilitate Web-authentication for client PCs with dynamic IP configuration, it was not an ideal solution, since the DHCP service was shared between Web-authentication clients and Guest VLAN users.

In this release there is now a DHCP server dedicated to serving IP addresses for use by Web-authentication clients.

See the [auth-web-server dhcp ip address command on page 57.32](#) and the [auth-web-server dhcp lease command on page 57.33](#) for details about configuring the Web-authentication DHCP Server.

Interception of clients' ARPs

A client PC's IP communications will always be preceded by sending out ARP (Address Resolution Protocol) requests for host addresses in its local subnet, or for its gateway address. If the IP address and gateway address have been statically configured on the client PC, and the subnet used in this static configuration is different to that on the authenticating switch, then the ARP requests will receive no reply, and the PC will not begin IP communications.

So, a switch operating as a Web Authenticator needs a method for replying to arbitrary ARP requests, to enable the client PC to proceed to the HTTP session required to perform Web-authentication.

In this release, the Web-authentication server can operate in three modes:

- **No interception:** only responds to ARP requests for its own IP address (this is the operation of the Web-authentication server in previous versions of AlliedWare Plus™).
- **Intercept mode:** will respond to ARP requests from any IP address that is in the same subnet as the switch's own IP address, and will provide its own MAC address in the ARP reply, irrespective of what IP address (within its own subnet) was being requested.
- **Promiscuous mode:** will respond to any ARP request, irrespective of whether the requested IP address is in the same subnet as the switch's IP address or not. It will provide its own MAC address in the ARP reply, irrespective of what IP address was being requested.

The addition of this functionality allows you to configure the Web-authentication server to interoperate with any static IP configuration on a client PC.

See the [auth-web-server mode command on page 57.36](#) for command information about setting the Web-authentication mode.

Proxy DNS response

Typically, an HTTP session from a web browser is preceded by a DNS request for the IP address of the website the user wishes to browse to. If the DNS request does not receive a reply, then the web browser will never proceed to connect an HTTP session.

Hence the Web-authentication server needs a mechanism to reply to DNS requests, so that the Web-authentication session can begin. The Web-authentication modes also control the operation of Proxy DNS replies from the Web-authentication server as listed below:

- **No interception:** does not respond to DNS requests
- **Intercept mode:** responds to DNS request whose source IP address is within the same subnet as the IP address on the switch. The IP address provided as the resolution of the DNS lookup is the switch's own IP address, so that the subsequent HTTP traffic will be directed to the switch.
- **Promiscuous mode:** responds to DNS requests from any source IP address. The IP address provided as the resolution of the DNS lookup is the switch's own IP address, so that the subsequent HTTP traffic will be directed to the switch.

The combination of these enhancements ensure that, irrespective of the IP configuration on the client PC, Web-authentication will proceed smoothly.

See the [auth-web-server mode command on page 57.36](#) for command information about setting the Web-authentication mode.

Guest VLAN Enhancements

In previous releases, traffic from unauthenticated supplicants in the Guest VLAN could only be L2 switched within the Guest VLAN.

As a result, it was not possible for DHCP requests from host in the Guest VLAN to be relayed to a DHCP server in another VLAN. Hence, for hosts in the Guest VLAN to obtain DHCP leases, the DHCP Server needed to have an interface in the Guest VLAN, or the authenticating switch needed to act as a DHCP Server. Either of these options could be inconvenient, or possibly even something of a security risk.

Additionally, supplicants in the Guest VLAN who needed to log into a Domain Controller, as part of becoming integrated into a NAC solution, could not access the Domain Controller if it was in another VLAN.

In this release, there is now an option to enable routing from the Guest VLAN. By default, traffic from unauthenticated supplicants in the Guest VLAN will still only be L2 switched within the Guest VLAN. But, if the **routing** parameter for the **auth guest vlan** command is configured, then the switch will route unauthenticated supplicants' traffic to other VLANs if required, and will relay their DHCP requests to servers in other VLANs if required.

See the [auth guest-vlan command on page 57.8](#) for command information about Guest VLAN feature enhancements.

Failed authentication VLAN

The auth-fail VLAN feature allows the Network Administrator to separate the supplicants who attempted authentication, but failed, from the supplicants who did not attempt authentication.

This feature enables the Network Administrator to enact a security policy in which the supplicants who fail authentication are given extremely limited access, or are given access to remedial applications.

If the Guest VLAN and auth-fail VLAN are both configured on a switch, then a newly connected supplicant initially belongs to the Guest VLAN. If newly connected supplicants attempt 802.1X port authentication or Web-authentication and fail, then they are moved from the Guest VLAN to the auth-fail VLAN.

The criteria for how many failed authentication attempts are allowed before the supplicant is moved to the auth-fail VLAN differs, depending on the authentication method used.

If Web-authentication is used, then the supplicant is moved to the auth-fail VLAN after the first failed attempt. If 802.1X port authentication is used, then the supplicant is moved to the auth-fail VLAN after the number of failed attempts is equal to the value configured by the **dot1x max-auth-fail** command (by default, three failed 802.1X authentication attempts are allowed).

Note that the auth-fail VLAN feature is not applicable for MAC authentication. Supplicants failing MAC authentication remain in the Guest VLAN and will not move to the auth-fail VLAN.

See the [auth auth-fail vlan command on page 57.3](#) and the [dot1x max-auth-fail command on page 55.8](#) for command information about the failed authentication vlan feature when using 802.1X port authentication on an interface.

Limitations on allowed feature combinations

Note that the Web-authentication feature and enhancements cannot be used with the Guest VLAN or auth-fail VLAN features. For further limitation information see the below tables:

Figure 56-3: Interoperation of authentication types with Guest VLAN and auth-fail VLAN

Authentication Type:	Guest VLAN (without routing mode)	Guest VLAN (with routing mode)	Failed Authentication VLAN
802.1X Port-based Authentication	No change in functionality from previous releases	Unauthorized supplicant can access Guest VLAN. Use ACL for security on the interface.	Failed authentication supplicant can access auth-fail VLAN. See limitations table below for ACL usage limitation.
MAC Authentication	No change in functionality from previous releases	Unauthorized supplicant can access Guest VLAN. Use ACL for security on the interface.	(Not Available)
Web-based Authentication (without intercept mode)	No change in functionality from previous releases	Unauthorized supplicant can access Guest VLAN. Use ACL for security on the interface.	Failed authentication supplicant can access auth-fail VLAN. See limitations table below for ACL usage limitation.
Web-based Authentication (with intercept mode)	(Not Available)	(Not Available)	(Not Available)

Figure 56-4: Interactions between Guest VLAN and auth-fail VLAN

Authentication Feature:	Guest VLAN (without routing mode)	Guest VLAN (with routing mode)	Failed Authentication VLAN
Guest VLAN (without routing mode)	(Not Available)	(Not Available)	Cannot configure ACLs on the Guest VLAN when it is not in routing mode. The Guest VLAN without routing mode has reserved ACLs already attached to it.
Guest VLAN (with routing mode)	(Not Available)	(Not Available)	Configuration of ACLs for additional interface security is recommended.
Failed Authentication VLAN	Cannot configure ACLs on the Guest VLAN when it is not in routing mode. The Guest VLAN without routing mode has reserved ACLs already attached to it.	Configuration of ACLs for additional interface security is recommended.	(Not Available)

Chapter 57: Authentication Commands



Command List	57.3
auth auth-fail vlan	57.3
auth critical.....	57.5
auth dynamic-vlan-creation	57.6
auth guest-vlan.....	57.8
auth host-mode	57.10
auth log	57.11
auth max-suppliant.....	57.12
auth reauthentication.....	57.13
auth roaming disconnected.....	57.14
auth roaming enable.....	57.16
auth supplicant-mac.....	57.18
auth timeout quiet-period	57.20
auth timeout reauth-period	57.21
auth timeout server-timeout.....	57.22
auth timeout supp-timeout.....	57.23
auth-mac enable	57.24
auth-mac method.....	57.25
auth-mac reauth-relearning.....	57.26
auth-web enable.....	57.27
auth-web forward.....	57.28
auth-web max-auth-fail.....	57.30
auth-web method.....	57.31
auth-web-server dhcp ip address.....	57.32
auth-web-server dhcp lease.....	57.33
auth-web-server http-redirect.....	57.34
auth-web-server ipaddress.....	57.35
auth-web-server mode.....	57.36
auth-web-server ping-poll enable.....	57.38
auth-web-server ping-poll failcount.....	57.39
auth-web-server ping-poll interval	57.40
auth-web-server ping-poll reauth-fresh.....	57.41
auth-web-server ping-poll timeout.....	57.42
auth-web-server port	57.43
auth-web-server redirect-url.....	57.44
auth-web-server session-keep.....	57.45
auth-web-server ssl.....	57.45
auth-web-server sslport	57.46
copy web-auth-https-file.....	57.47
erase web-auth-https-file.....	57.47
show auth-mac.....	57.48
show auth-mac diagnostics.....	57.49
show auth-mac interface	57.50
show auth-mac sessionstatistics.....	57.52
show auth-mac statistics interface.....	57.53
show auth-mac supplicant	57.54
show auth-mac supplicant interface.....	57.55

show auth-web.....	57.56
show auth-web diagnostics.....	57.57
show auth-web interface	57.58
show auth-web sessionstatistics.....	57.60
show auth-web statistics interface.....	57.61
show auth-web supplicant	57.62
show auth-web supplicant interface.....	57.63
show auth-web-server.....	57.64

Command List

This chapter provides an alphabetical reference for Authentication commands. For more information, see [Chapter 56, Authentication Configuration](#), and [Chapter 59, AAA Commands](#).

auth auth-fail vlan

Use this command to enable the **auth-fail vlan** feature on the specified vlan interface. This feature assigns supplicants (client devices), which have failed port authentication, to the specified VLAN interface.

Use the **no** variant of this command to disable the **auth-fail vlan** feature for a specified VLAN interface.

Syntax `auth auth-fail vlan <1-4094>`

`no auth auth-fail vlan`

Parameter	Description
<1-4094>	Assigns the VLAN ID to any supplicants that have failed port authentication.

Default The **auth-fail vlan** feature is disabled by default.

Mode Interface Configuration for a static channel, a dynamic (LACP) channel group, or a switch port.

Usage Use the **auth-fail vlan** feature when using Web-authentication instead of the Guest VLAN feature, when you need to separate networks where one supplicant (client device) requires authentication and another supplicant does not require authentication from the same interface.

This is because the DHCP lease time using the Web authentication feature is shorter, and the **auth fail vlan** feature enables assignment to a different VLAN if a supplicant fails authentication.

When using 802.1X port authentication, use a **dot1x max-auth-fail** command to set the maximum number of login attempts. Three login attempts are allowed by default for 802.1X port authentication before supplicants trying to authenticate are moved from the Guest VLAN to the auth-fail VLAN. See the [“dot1x max-auth-fail” on page 55.8](#) for command information.

See the section [“Failed authentication VLAN” on page 56.11](#) in [Chapter 56, Authentication Configuration](#) for further overview information about the auth-fail VLAN feature, which allows the Network Administrator to separate the supplicants who attempted authentication, but failed, from the supplicants who did not attempt authentication.

See the section [“Limitations on allowed feature combinations” on page 56.12](#) for information about restrictions regarding combinations of authentication enhancements working together.

Use appropriate ACLs (Access Control Lists) on interfaces for extra security if a supplicant allocated to the designated auth-fail vlan can access the same network as a supplicant on the Guest VLAN. For more information about ACL concepts, and configuring ACLs see [Chapter 49, Access Control Lists Introduction](#). For more information about ACL commands see [Chapter 50, IPv4 Access Control List \(ACL\) Commands](#) and [Chapter 51, IPv6 Access Control List \(ACL\) Commands](#).

Examples To enable **auth-fail vlan** for `port1.0.2` and assign VLAN 100, use the below commands:

```
awplus# configure terminal
awplus(config)# interface port1.0.2
awplus(config-if)# auth auth-fail vlan 100
```

To disable the **auth-fail vlan** feature for `port1.0.2`, use the below commands:

```
awplus# configure terminal
awplus(config)# interface port1.0.2
awplus(config-if)# no auth auth-fail vlan
```

**Validation
Commands** `show running-config`

Related Commands `dot1x max-auth-fail`
`show dot1x`
`show dot1x interface`

auth critical

This command enables the critical port feature on the interface. When the critical port feature is enabled on an interface, and all the RADIUS servers are unavailable, then the interface becomes authorized.

The **no** variant of this command disables critical port feature on the interface.

Syntax `auth critical`

`no auth critical`

Default The critical port of port authentication is disabled.

Mode Interface Configuration for a static channel, a dynamic (LACP) channel group, or a switch port.

Examples To enable the critical port feature on interface `port1.0.2`, use the commands:

```
awplus# configure terminal
awplus(config)# interface port1.0.2
awplus(config-if)# auth critical
```

To disable the critical port feature on interface `port1.0.2`, use the commands:

```
awplus# configure terminal
awplus(config)# interface port1.0.2
awplus(config-if)# no auth critical
```

**Validation
Commands** `show auth-web-server`
`show dot1x`
`show dot1x interface`
`show running-config`

auth dynamic-vlan-creation

This command enables and disables the Dynamic VLAN assignment feature.

The Dynamic VLAN assignment feature allows a supplicant (client device) to be placed into a specific VLAN based on information returned from the RADIUS server during authentication, on a given interface.

Use the **no** variant of this command to disable the Dynamic VLAN assignment feature.

Syntax `auth dynamic-vlan-creation [rule {deny|permit}]`

`no auth dynamic-vlan-creation`

Parameter	Description
<code>rule</code>	VLAN assignment rule
<code>deny</code>	Deny a differently assigned VLAN ID. This is the default rule.
<code>permit</code>	Permit a differently assigned VLAN ID

Default By default, the Dynamic VLAN assignment feature is disabled.

Mode Interface Configuration for a static channel, a dynamic (LACP) channel group, or a switch port.

Usage If the Dynamic VLAN assignment feature is enabled (disabled by default), VLAN assignment is dynamic. If the Dynamic VLAN assignment feature is disabled then RADIUS attributes are ignored and configured VLANs are assigned to ports.

The optional **rule** parameter specifies the VLAN assignment rule when the second supplicant's VLAN ID is different from VLAN ID from the first supplicant. If the **deny** value is applied with the command then the second supplicant with a different VLAN ID is rejected. If the **permit** value is applied with the command then the second supplicant with a different VLAN ID is accepted and assigned to the first supplicant's VLAN.

If you issue an **auth dynamic-vlan-creation** command without an optional **rule** parameter and a required **deny** or **permit** keyword value then a second supplicant with a different VLAN ID is rejected. It is not assigned to the first supplicant's VLAN. Issuing an **auth dynamic-vlan-creation** command without an optional **rule** parameter has the same effect as issuing an **auth dynamic-vlan-creation rule deny** command rejecting supplicants with differing VLAN IDs.

Examples To enable the Dynamic VLAN assignment feature on interface `port1.0.2`, use the commands:

```
awplus# configure terminal
awplus(config)# interface port1.0.2
awplus(config-if)# auth dynamic-vlan-creation
```

To disable the Dynamic VLAN assignment feature on interface `port1.0.2`, use the commands:

```
awplus# configure terminal
awplus(config)# interface port1.0.2
awplus(config-if)# no auth dynamic-vlan-creation
```

**Validation
Commands** `show dot1x`
 `show dot1x interface`
 `show running-config`

Related Commands `auth host-mode`

auth guest-vlan

This command enables and configures the Guest VLAN feature on the interface specified by associating a Guest VLAN with an interface. This command does not start authentication. The supplicant's (client device's) traffic is associated with the native VLAN of the interface if its not already associated with another VLAN. The **routing** option enables routing from the Guest VLAN to another VLAN, so the switch can lease DHCP addresses and accept access to a limited network.

The **no** variant of this command disables the guest vlan feature on the interface specified.

Syntax `auth guest-vlan <1-4094> [routing]`
`no auth guest-vlan [routing]`

Parameter	Description
<1-4094>	VLAN id (VID).
routing	Enables routing from the Guest VLAN to other VLANs.

Default The Guest VLAN authentication feature is disabled by default.

Mode Interface Configuration for a static channel, a dynamic (LACP) channel group, or a switch port.

Usage The Guest VLAN feature may be used by supplicants (client devices) that have not attempted authentication, or have failed the authentication process. Note that if a port is in multi-supplicant mode with per-port dynamic VLAN configuration, after the first successful authentication, subsequent hosts cannot use the guest VLAN due to the change in VLAN ID. This may be avoided by using per-user dynamic VLAN assignment.

When using the Guest VLAN feature with the multi-host mode, a number of supplicants can communicate via a guest VLAN before authentication. A supplicant's traffic is associated with the native VLAN of the specified switch port. The supplicant must belong to a VLAN before traffic from the supplicant can be associated.

Note that you must first define the VLAN with the **vlan** command that you will assign as a guest VLAN using this command. Also note that 802.1X must first be enabled on the port.

Guest VLAN authentication cannot be enabled if DHCP snooping is enabled ([service dhcp-snooping command on page 68.21](#)), and vice versa.

The Guest VLAN feature in previous releases had some limitations that have been removed. Until this release the Guest VLAN feature could not lease the IP address to the supplicant using DHCP Server or DHCP Relay features unless Web authentication was also applied. When using NAP authentication, the supplicant should have been able to log on to a domain controller to gain certification, but the Guest VLAN would not accept access to another VLAN.

The Guest VLAN routing mode in this release overcomes these issues. With the Guest VLAN routing mode, the switch can lease DHCP addresses and accept access to a limited network.

See the section "[Guest VLAN Enhancements](#)" on [page 56.10](#) for further overview information about the enhancements to the Guest VLAN feature.

See the section [“Limitations on allowed feature combinations”](#) on page 56.12 for information about restrictions regarding combinations of authentication enhancements working together.

Examples To define `vlan100` and assign the guest VLAN feature to `vlan100` on interface `port1.0.2`, and enable routing from the guest vlan to other VLANs, use the following commands:

```
awplus# configure terminal
awplus(config)# vlan database
awplus(config-vlan)# vlan 100
awplus(config-vlan)# exit
awplus(config)# interface port1.0.2
awplus(config-if)# dot1x port-control auto
awplus(config-if)# auth guest-vlan 100 routing
```

To disable the guest vlan feature on interface `port1.0.2`, use the following commands:

```
awplus# configure terminal
awplus(config)# interface port1.0.2
awplus(config-if)# no auth guest-vlan
```

**Validation
Commands** `show dot1x`
`show dot1x interface`
`show running-config`

Related Commands `dot1x port-control`
`vlan`

auth host-mode

This command selects host mode on the interface. Multi-host is an extension to IEEE802.1X. Use the **no** variant of this command to set host mode to the default setting (single host).

Syntax `auth host-mode {single-host|multi-host|multi-supPLICANT}`
`no auth host-mode`

Parameter	Description
single-host	Single host mode.
multi-host	Multi host mode.
multi-supPLICANT	Multi supplicant (client device) mode.

Default The default host mode for port authentication is for a single host.

Mode Interface Configuration for a static channel, a dynamic (LACP) channel group, or a switch port.

Examples To set the host mode to multi-supPLICANT on interface port 1.0.2, use the following commands:

```
awplus# configure terminal
awplus(config)# interface port1.0.2
awplus(config-if)# auth host-mode multi-supPLICANT
```

To set the host mode to default (single host) on interface port 1.0.2, use the following commands:

```
awplus# configure terminal
awplus(config)# interface port1.0.2
awplus(config-if)# no auth host-mode
```

Validation Commands `show dot1x`
`show dot1x interface`
`show running-config`

auth log

Use this command to configure the types of authentication feature log messages that are output to the log file.

Use the **no** variant of this command to remove either specified types or all types of authentication feature log messages that are output to the log file.

Syntax `auth log {dot1x|auth-mac|auth-web} {success|failure|logoff|all}`
`no auth log {dot1x|auth-mac|auth-web} {success|failure|logoff|all}`

Parameter	Description
<code>dot1x</code>	Specify only 802.1X authentication log messages are output to the log file.
<code>auth-mac</code>	Specify only MAC authentication log messages are output to the log file.
<code>auth-web</code>	Specify only Web authentication log messages are output to the log file.
<code>success</code>	Specify only successful authentication log messages are output to the log file.
<code>failure</code>	Specify only authentication failure log messages are output to the log file.
<code>logoff</code>	Specify only authentication logoff messages are output to the log file. Note that link down, age out and expired ping polling messages will be included.
<code>all</code>	Specify all types of authentication log messages are output to the log file. Note that this is the default behavior for the authentication logging feature.

Default All types of authentication log messages are output to the log file by default.

Mode Interface Configuration

Examples To configure the logging of MAC authentication failures to the log file for supplicants (client devices) connected to interface `port1.0.2`, use the following commands:

```
awplus# configure terminal
awplus(config)# interface port1.0.2
awplus(config-if)# auth log auth-mac failure
```

To configure the logging of all types of authentication log messages to the log file for supplicants (client devices) connected to interface `port1.0.2`, use the following commands:

```
awplus# configure terminal
awplus(config)# interface port1.0.2
awplus(config-if)# no auth log all
```

Validation Commands `show running-config`

auth max-supPLICant

This command sets the maximum number of supplicants (client devices) on the interface that can be authenticated. After this value is exceeded supplicants are not authenticated.

The **no** variant of this command resets the maximum supplicant number to the default (1024).

Syntax `auth max-supPLICant <2-1024>`

`no auth max-supPLICant`

Parameter	Description
<2-1024>	Limit number.

Default The max supplicant of port authentication is 1024.

Mode Interface Configuration for a static channel, a dynamic (LACP) channel group, or a switch port.

Examples To set the maximum number of supplicants to 10 on interface `port1.0.2`, use the following commands:

```
awplus# configure terminal
awplus(config)# interface port1.0.2
awplus(config-if)# auth max-supPLICant 10
```

To reset the maximum number of supplicant to default on interface `port1.0.2`, use the following commands:

```
awplus# configure terminal
awplus(config)# interface port1.0.2
awplus(config-if)# no auth max-supPLICant
```

Validation Commands `show dot1x`
`show dot1x interface`
`show running-config`

auth reauthentication

This command enables re-authentication on the interface specified in the Interface mode, which may be a static channel group (or static aggregator) or a dynamic (or LACP) channel group or a switch port.

Use the **no** variant of this command to disables reauthentication on the interface.

Syntax `auth reauthentication`
`no auth reauthentication`

Default Reauthentication of port authentication is disabled by default.

Mode Interface Configuration for a static channel, a dynamic (LACP) channel group, or a switch port.

Examples To enable reauthentication on interface `port1.0.2`, use the following commands:

```
awplus# configure terminal
awplus(config)# interface port1.0.2
awplus(config-if)# auth reauthentication
```

To disable reauthentication on interface `port1.0.2`, use the following commands:

```
awplus# configure terminal
awplus(config)# interface port1.0.2
awplus(config-if)# no auth reauthentication
```

**Validation
Commands** `show dot1x`
`show dot1x interface`
`show running-config`

auth roaming disconnected

This command enables the roaming authentication feature on an authenticated interface that is link down. A supplicant (a client device) is not reauthenticated when moved between authenticated interfaces, providing both interfaces have the roaming authentication feature enabled before the supplicant is moved.

Use the [auth roaming enable](#) command before using this command. The [auth roaming disconnected](#) command on its own will have no effect on the operation of the switch. This command will only come into effect once the base Roaming Authentication feature is enabled, using the [auth roaming enable](#) command.

The **no** variant of this command disables the roaming authentication feature on an interface, and forces a supplicant to be reauthenticated when moving between interfaces.

See [“Roaming Authentication” on page 56.4](#) for further information about this feature.

Syntax `auth roaming disconnected`
`no auth roaming disconnected`

Default The roaming authentication `disconnected` feature is disabled by default on an interface. Authentication status for a roaming supplicant is deleted by default when an interface goes down.

Mode Interface Configuration for a static channel, a dynamic (LACP) channel group, or a switch port.

Usage This command allows a supplicant to move to another authenticating interface without reauthentication, if the link is down for the interface that the supplicant is moved from.

Note that 802.1X port authentication, or MAC authentication, or Web Authentication must first be enabled on an interface to use this feature. The port that the supplicant is moving to must have the same authentication configuration as the port the supplicant is moving from.

Configure [auth roaming enable](#) on an interface before configuring [auth roaming disconnected](#) if you require [auth roaming disconnected](#) configured on an interface for a roaming supplicant.

Roaming authentication cannot be enabled if DHCP snooping is enabled ([service dhcp-snooping command on page 68.21](#)), and vice versa.

Examples To enable roaming authentication `disconnected` feature for `port1.0.2`, after enabling 802.1x authentication and enabling roaming authentication `enable`, use the commands:

```
awplus# configure terminal
awplus(config)# interface port1.0.2
awplus(config-if)# dot1x port-control auto
awplus(config-if)# auth roaming enable
awplus(config-if)# auth roaming disconnected
```

To disable roaming authentication disconnected feature for port1.0.2, use the commands:

```
awplus# configure terminal
awplus(config)# interface port1.0.2
awplus(config-if)# no auth roaming disconnected
```

**Validation
Commands** show running-config

Related Commands auth-mac enable
auth roaming enable
auth-web enable
dot1x port-control
show auth-mac interface
show auth-web interface
show dot1x interface

auth roaming enable

This command enables the roaming authentication feature on an authenticated interface that is link up. A supplicant (a client device) is not reauthenticated when moved between authenticated interfaces, providing both interfaces have the roaming authentication feature enabled before the supplicant is moved.

Use the [auth roaming enable](#) command before using [auth roaming disconnected](#) command. The [auth roaming disconnected](#) command on its own will have no effect on the operation of the switch. This command will only come into effect once the base Roaming Authentication feature is enabled, using the [auth roaming enable](#) command.

The **no** variant of this command disables the roaming authentication feature on an interface, and forces a supplicant to be reauthenticated when moving between interfaces.

See [“Roaming Authentication” on page 56.4](#) for further information about this feature.

Syntax `auth roaming enable`
`no auth roaming enable`

Default The roaming authentication enable feature is disabled by default on an interface. Authentication status for a roaming supplicant is deleted by default when an interface goes down.

Mode Interface Configuration for a static channel, a dynamic (LACP) channel group, or a switch port.

Usage This command allows a supplicant to move to another authenticating interface without reauthentication, providing the link is up for the interface that the supplicant is moved from.

Note that 802.1X port authentication, or MAC authentication, or Web Authentication must first be enabled on an interface to use this feature. The port that the supplicant is moving to must have the same authentication configuration as the port the supplicant is moving from.

Configure [auth roaming enable](#) on an interface before configuring [auth roaming disconnected](#) if you require [auth roaming disconnected](#) configured on an interface for a roaming supplicant.

Roaming authentication cannot be enabled if DHCP snooping is enabled ([service dhcp-snooping command on page 68.21](#)), and vice versa.

Examples To enable the roaming authentication enable feature for interface `port1.0.4`, after enabling 802.1x authentication, since an authentication method is required, use the following commands:

```
awplus# configure terminal
awplus(config)# interface port1.0.4
awplus(config-if)# dot1x port-control auto
awplus(config-if)# auth roaming enable
```

To disable roaming authentication enable for `port1.0.4`, use the following commands:

```
awplus# configure terminal
awplus(config)# interface port1.0.4
awplus(config-if)# no auth roaming enable
```

**Validation
Commands** show running-config

Related Commands auth-mac enable
 auth roaming disconnected
 auth-web enable
 dot1x port-control
 show auth-mac interface
 show auth-web interface
 show dot1x interface

auth supplicant-mac

This command adds a supplicant (client device) mac address on a given interface with the parameters as specified in the table below.

Use the **no** variant of this command to delete the supplicant MAC address added by the **auth supplicant-mac** command, and resets to the default for the supplicant parameter.

Syntax

```

auth supplicant <mac-addr>
  [max-reauth-req <1-10>]
  [port-control {auto | force-authorized | force-unauthorized}]
  [quiet-period <1-65535>]
  [reauth-period <1-4294967295>]
  [supp-timeout <1-65535>]
  [server-timeout <1-65535>] [reauthentication]

no auth supplicant-mac <macadd> [reauthentication]

```

Parameter	Description
<mac-addr>	MAC (hardware) address of the Supplicant entry in HHHH.HHHH.HHHH MAC address hexadecimal format.
port-control	Port control commands.
auto	Allow port client to negotiate authentication.
force-authorized	Force port state to authorized.
force-unauthorized	Force port state to unauthorized.
quiet-period	Quiet period in the HELD state (default 60 seconds).
<1-65535>	Seconds for quiet period.
reauth-period	Seconds between reauthorization attempts (default 3600 seconds).
<1-4294967295>	Seconds for reauthorization attempts (reauth-period).
supp-timeout	Supplicant response timeout (default 30 seconds).
<1-65535>	Seconds for supplicant response timeout.
server-timeout	Authentication server response timeout (default 30 seconds).
<1-65535>	Seconds for authentication server response timeout.
reauthentication	Enable reauthentication on a port.
max-reauth-req	No of reauthentication attempts before becoming unauthorized (default 2).
<1-10>	Count of reauthentication attempts.

Default No supplicant MAC address for port authentication exists by default until first created with the `auth supplicant-mac` command. The defaults for parameters applied are as shown in the table.

Mode Interface Configuration for a static channel, a dynamic (LACP) channel group, or a switch port.

Examples To add the supplicant MAC address 0009.41A4.5943 to force authorized port control for interface `port1.0.2`, use the following commands:

```
awplus# configure terminal
awplus(config)# interface port1.0.2
awplus(config-if)# auth supplicant-mac 0009.41A4.5943 port-
control force-authorized
```

To delete the supplicant MAC address 0009.41A4.5943 for interface `port1.0.2`, use the following commands:

```
awplus# configure terminal
awplus(config)# interface port1.0.2
awplus(config-if)# no auth supplicant-mac 0009.41A4.5943
```

To reset reauthentication to disable for the supplicant MAC address 0009.41A4.5943, for interface `port1.0.2` use the following commands:

```
awplus# configure terminal
awplus(config)# interface port1.0.2
awplus(config-if)# no auth supplicant-mac 0009.41A4.5943
reauthentication
```

**Validation
Commands** `show dot1x`
`show dot1x interface`
`show running-config`

auth timeout quiet-period

This command sets the time period for which the authentication request is not accepted on a given interface, after the authentication request has failed an authentication.

Use the **no** variant of this command to reset quiet period to the default (60 seconds).

Syntax `auth timeout quiet-period <1-65535>`
`no auth timeout quiet-period`

Parameter	Description
<1-65535>	Seconds.

Default The quiet period of port authentication is 60 seconds.

Mode Interface Configuration for a static channel, a dynamic (LACP) channel group, or a switch port.

Examples To set the quiet period to 10 for interface `port1.0.2`, use the following commands:

```
awplus# configure terminal
awplus(config)# interface port1.0.2
awplus(config-if)# auth timeout quiet-period 10
```

To reset the quiet period to the default (60 seconds) for interface `port1.0.2`, use the following commands:

```
awplus# configure terminal
awplus(config)# interface port1.0.2
awplus(config-if)# no auth timeout quiet-period
```

auth timeout reauth-period

This command sets the timer for reauthentication on a given interface. The re-authentication for the supplicant (client device) is executed at this timeout. The timeout is only applied if the `auth reauthentication` command is applied.

Use the `no` variant of this command to reset the `reauth-period` parameter to the default value (3600 seconds).

Syntax `auth timeout reauth-period <1-4294967295>`

`no auth timeout reauth-period`

Parameter	Description
<code><1-4294967295></code>	Seconds.

Default The default reauthentication period for port authentication is 3600 seconds, when reauthentication is enabled on the port.

Mode Interface Configuration for a static channel, a dynamic (LACP) channel group, or a switch port.

Examples To set the reauthentication period to 1 day for interface `port1.0.2`, use the following commands:

```
awplus# configure terminal
awplus(config)# interface port1.0.2
awplus(config-if)# auth timeout reauth-period 86400
```

To reset the reauthentication period to the default (3600 seconds) for interface `port1.0.2`, use the following commands:

```
awplus# configure terminal
awplus(config)# interface port1.0.2
awplus(config-if)# no auth timeout reauth-period
```

**Validation
Commands** `show dot1x`
`show dot1x interface`
`show running-config`

Related Commands `auth reauthentication`

auth timeout server-timeout

This command sets the timeout for the waiting response from the RADIUS server on a given interface.

The **no** variant of this command resets the server-timeout to the default value (30 seconds).

Syntax

```
auth timeout server-timeout <1-65535>
no auth timeout server-timeout
```

Parameter	Description
<1-65535>	Seconds.

Default The server timeout for port authentication is 30 seconds.

Mode Interface Configuration for a static channel, a dynamic (LACP) channel group, or a switch port.

Examples To set the server timeout to 120 seconds for interface `port1.0.2`, use the following commands:

```
awplus# configure terminal
awplus(config)# interface port1.0.2
awplus(config-if)# auth timeout server-timeout 120
```

To set the server timeout to the default (30 seconds) for interface `port1.0.2`, use the following commands:

```
awplus# configure terminal
awplus(config)# interface port1.0.2
awplus(config-if)# no auth timeout server-timeout
```

Validation Commands

```
show dot1x
show dot1x interface
show running-config
```

auth timeout supp-timeout

This command sets the timeout of the waiting response from the supplicant (client device) on a given interface.

The **no** variant of this command resets the supplicant timeout to the default (30 seconds).

Syntax `auth timeout supp-timeout <1-65535>`

`no auth timeout supp-timeout`

Parameter	Description
<1-65535>	Seconds.

Default The supplicant timeout of port authentication is 30 seconds.

Mode Interface Configuration for a static channel, a dynamic (LACP) channel group, or a switch port.

Examples To set the server timeout to 2 seconds for interface `port1.0.2`, use the following commands:

```
awplus# configure terminal
awplus(config)# interface port1.0.2
awplus(config-if)# auth timeout supp-timeout 2
```

To reset the server timeout to the default (30 seconds) for interface `port1.0.2`, use the following commands:

```
awplus# configure terminal
awplus(config)# interface port1.0.2
awplus(config-if)# no auth timeout supp-timeout
```

Validation Commands `show dot1x`
`show dot1x interface`
`show running-config`

auth-mac enable

This command enables MAC based authentication on the interface specified in the Interface command mode.

Use the **no** variant of this command to disable MAC based authentication on an interface.

Syntax `auth-mac enable`
`no auth-mac enable`

Default MAC authentication is disabled by default.

Mode Interface Configuration for a static channel, a dynamic (LACP) channel group, or a switch port.

Usage Enabling **spanning-tree edgeport** on ports after enabling MAC based authentication avoids unnecessary re-authentication when the port state changes, which does not happen when spanning tree edgeport is enabled. Note that re-authentication is correct behavior without **spanning-tree edgeport** enabled.

Applying **switchport mode access** on ports is also good practice to set the ports to access mode with ingress filtering turned on, whenever ports for MAC authentication are in a VLAN.

Examples To enable MAC authentication on interface port 1.0.2 , use the following commands:

```
awplus# configure terminal
awplus(config)# interface port1.0.2
awplus(config-if)# auth-mac enable
awplus(config-if)# spanning-tree edgeport
awplus(config-if)# switchport mode access
```

To disable MAC authentication on interface port 1.0.2 , use the following commands:

```
awplus# configure terminal
awplus(config)# interface port1.0.2
awplus(config-if)# no auth-mac enable
```

Validation Commands `show auth-mac`
`show auth-mac interface`
`show running-config`

Related Commands `aaa accounting auth-mac default`
`aaa authentication auth-mac`
`spanning-tree edgeport (RSTP and MSTP)`
`switchport mode access`

auth-mac method

This command sets the type of authentication method for MAC authentication that is used with RADIUS on the interface specified in the Interface command mode.

The **no** variant of this command resets the authentication method used to the default method (PAP) as the RADIUS authentication method used by the MAC authentication.

Syntax `auth-mac method [eap-md5|pap]`
`no auth-mac method`

Parameter	Description
<code>eap-md5</code>	Enable EAP-MD5 of authentication method.
<code>pap</code>	Enable PAP of authentication method.

Default The mac authentication method is PAP.

Mode Interface Configuration for a static channel, a dynamic (LACP) channel group, or a switch port.

Examples To set the MAC authentication method to `pap` on interface `port1.0.2`, use the following commands:

```
awplus# configure terminal
awplus(config)# interface port1.0.2
awplus(config-if)# auth-mac method pap
```

To set the MAC authentication method to the default on interface `port1.0.2`, use the following commands:

```
awplus# configure terminal
awplus(config)# interface port1.0.2
awplus(config-if)# no auth-mac method
```

Validation Commands `show auth-mac`
`show auth-mac interface`
`show running-config`

auth-mac reauth-relearning

This command sets the MAC address learning of the supplicant (client device) to re-learning for re-authentication on the interface specified in the Interface command mode.

Use the **no** variant of this command to disable the auth-mac re-learning option.

Syntax `auth-mac reauth-relearning`

`no auth-mac reauth-relearning`

Default Re-learning for port authentication is disabled by default.

Mode Interface Configuration for a static channel, a dynamic (LACP) channel group, or a switch port.

Examples To enable the re-authentication re-learning feature on interface `port1.0.2`, use the following commands:

```
awplus# configure terminal
awplus(config)# interface port1.0.2
awplus(config-if)# auth-mac reauth-relearning
```

To disable the re-authentication re-learning feature on interface `port1.0.2`, use the following commands:

```
awplus# configure terminal
awplus(config)# interface port1.0.2
awplus(config-if)# no auth-mac reauth-relearning
```

**Validation
Commands** `show auth-mac`
`show auth-mac interface`
`show running-config`

auth-web enable

This command enables Web-based authentication in Interface mode on the interface specified.

Use the **no** variant of this command to disable Web-based authentication on an interface.

Syntax `auth-web enable`
`no auth-web enable`

Default Web authentication is disabled by default.

Mode Interface Configuration for a static channel or a switch port.

Usage Web-based authentication cannot be enabled if DHCP snooping is enabled ([service dhcp-snooping command on page 68.21](#)), and vice versa.

Examples To enable Web authentication on static-channel-group 2, use the following commands:

```
awplus# configure terminal
awplus(config)# interface port1.0.2
awplus(config-if)# static-channel-group 2
awplus(config-if)# exit
awplus(config)# interface sa2
awplus(config-if)# auth-web enable
```

To disable Web authentication on static-channel-group 2, use the following commands:

```
awplus# configure terminal
awplus(config)# interface port1.0.2
awplus(config-if)# static-channel-group 2
awplus(config-if)# exit
awplus(config)# interface sa2
awplus(config-if)# no auth-web enable
```

**Validation
Commands** `show auth-web`
`show auth-web interface`
`show running-config`

Related Commands `aaa accounting auth-web default`
`aaa authentication auth-web`

auth-web forward

This command enables the web authentication packet forwarding feature on the interface specified. This command also enables ARP forwarding, and adds forwarded packets to the **tcp** or **udp** port number specified.

The **no** variant of this command disables or deletes the packet forwarding feature on the interface.

Syntax `auth-web forward {arp|dhcp|dns|tcp <1-65535>|udp <1-65535>}`
`no auth-web forward [arp|dhcp|dns|tcp <1-65535>|udp <1-65535>]`

Parameter	Description
arp	Enable forwarding of ARP.
dhcp	Enable forwarding of DHCP (67/udp).
dns	Enable forwarding of DNS (53/udp).
tcp	Enable forwarding of TCP specified port number.
<1-65535>	TCP Port number.
udp	Enable forwarding of UDP specified port number.
<1-65535>	UDP Port number.

Default Packet forwarding for port authentication is disabled by default.

Mode Interface Configuration for a static channel, a dynamic (LACP) channel group, or a switch port.

Examples To enable the arp forwarding feature on interface `port1.0.2`, use the following commands:

```
awplus# configure terminal
awplus(config)# interface port1.0.2
awplus(config-if)# auth-web forward arp
```

To add the tcp forwarding port 137 on interface `port1.0.2`, use the following commands:

```
awplus# configure terminal
awplus(config)# interface port1.0.2
awplus(config-if)# auth-web forward tcp 137
```

To disable the ARP forwarding feature on interface `port1.0.2`, use the following commands:

```
awplus# configure terminal
awplus(config)# interface port1.0.2
awplus(config-if)# no auth-web forward arp
```

To delete the tcp forwarding port 137 on interface `port1.0.2`, use the following commands:

```
awplus# configure terminal
awplus(config)# interface port1.0.2
awplus(config-if)# no auth-web forward tcp 137
```

To delete the all of tcp forwarding on interface `port1.0.2`, use the following commands:

```
awplus# configure terminal
awplus(config)# interface port1.0.2
awplus(config-if)# no auth-web forward tcp
```

Validation `show auth-web`
Commands `show auth-web interface`
`show running-config`

auth-web max-auth-fail

This command sets the number of authentication failures allowed before rejecting further authentication requests. When the supplicant (client device) fails more than has been set to the maximum number of authentication failures then login requests are refused during the quiet period.

The **no** variant of this command resets the maximum number of authentication failures to the default value (3 authentication failures).

Syntax `auth-web max-auth-fail <0-10>`

`no auth-web max-auth-fail`

Parameter	Description
<code><0-10></code>	Lock count specified.

Default The **max-auth-fail** lock counter is set to 3 authentication failures by default.

Mode Interface Configuration for a static channel, a dynamic (LACP) channel group, or a switch port.

Examples To set the lock count to 5 on interface `port1.0.2`, use the following commands:

```
awplus# configure terminal
awplus(config)# interface port1.0.2
awplus(config-if)# auth-web max-auth-fail 5
```

To set the lock count to the default on interface `port1.0.2`, use the following commands:

```
awplus# configure terminal
awplus(config)# interface port1.0.2
awplus(config-if)# no auth-web max-auth-fail
```

Validation Commands `show auth-web`
`show auth-web interface`
`show running-config`

Related Commands `auth timeout quiet-period`

auth-web method

This command sets the authentication method of WEB authentication that is used with RADIUS on the interface specified.

The **no** variant of this command sets the authentication method to PAP for the interface specified when Web authentication is also used with the RADIUS authentication method.

Syntax `auth-web method {eap-md5|pap}`
`no auth-web method`

Parameter	Description
<code>eap-md5</code>	Enable EAP-MD5 as the authentication method.
<code>pap</code>	Enable PAP as the authentication method.

Default The web authentication method is set to PAP by default.

Mode Interface Configuration for a static channel, a dynamic (LACP) channel group, or a switch port.

Example To set the web authentication method to eap-md5 on interface port 1.0.2, use the following commands:

```
awplus# configure terminal
awplus(config)# interface port1.0.2
awplus(config-if)# auth-web method eap-md5
```

Validation Commands `show auth-web`
`show auth-web interface`
`show running-config`

auth-web-server dhcp ip address

Use this command to assign an IP address and enable the DHCP service on the web authentication server for supplicants (client devices).

Use the **no** variant of this command to remove an IP address and disable the DHCP service on the web authentication server for supplicants.

Syntax `auth-web-server dhcp ip address <ip-address/prefix-length>`
`no auth-web-server dhcp ip address`

Parameter	Description
<code><ip-addr/prefix-length></code>	The IPv4 address and prefix length assigned for the DHCP service on the web authentication server for supplicants.

Default No IP address for the web authentication server is set by default.

Mode Global Configuration

Usage See the section [“DHCP Server for Web-authentication” on page 56.9](#) in [Chapter 56, Authentication Configuration](#) for further overview information about the Web-authentication enhancements, allowing Web-authentication to work as seamlessly as 802.1X authentication.

See the section [“Limitations on allowed feature combinations” on page 56.12](#) for information about restrictions regarding combinations of authentication enhancements working together.

Examples To assign the IP address 10.0.0.1 to the web authentication server, use the following commands:

```
awplus# configure terminal
awplus(config)# auth-web-server dhcp ip address 10.0.0.1/8
```

To remove an IP address on the web authentication server, use the following commands:

```
awplus# configure terminal
awplus(config)# no auth-web-server dhcp ip address
```

Validation Commands `show running-config`

Related Commands `show auth-web-server`
`auth-web-server dhcp lease`

auth-web-server dhcp lease

Use this command to set the DHCP lease time for supplicants (client devices) using the DHCP service on the web authentication server.

Use the **no** variant of this command to reset to the default DHCP lease time for supplicants using the DHCP service on the web authentication server.

Syntax `auth-web-server dhcp lease <20-60>`
`no auth-web-server dhcp lease`

Parameter	Description
<20-60>	DHCP lease time for supplicants using the DHCP service on the web authentication server in seconds.

Default The default DHCP lease time for supplicants using the DHCP service on the web authentication server is set to 30 seconds.

Mode Global Configuration

Usage See the section [“DHCP Server for Web-authentication” on page 56.9](#) in [Chapter 56, Authentication Configuration](#) for further overview information about the Web-authentication enhancements, allowing Web-authentication to work as seamlessly as 802.1X authentication.

See the section [“Limitations on allowed feature combinations” on page 56.12](#) for information about restrictions regarding combinations of authentication enhancements working together.

Examples To set the DHCP lease time to 1 minute for supplicants using the DHCP service on the web authentication server, use the following commands:

```
awplus# configure terminal
awplus(config)# auth-web-server dhcp lease 60
```

To reset the DHCP lease time to the default setting (30 seconds) for supplicants using the DHCP service on the web authentication server, use the following commands:

```
awplus# configure terminal
awplus(config)# no auth-web-server dhcp lease
```

Validation Commands `show running-config`

Related Commands `show auth-web-server`
`auth-web-server dhcp ip address`

auth-web-server http-redirect

This command enables the HTTP redirect feature on every interface on which web-based port authentication is enabled. When the HTTP redirect feature is enabled, any HTTP request received on an unauthorized interface is redirected to the web authentication server automatically.

Use the **no** variant of this command to disable the HTTP redirect feature.

Syntax `auth-web-server http-redirect`
`no auth-web-server http-redirect`

Default The HTTP redirect feature is enabled by default.

Mode Global Configuration

Examples To disable the HTTP redirect feature, use the following commands:

```
awplus# configure terminal
awplus(config)# no auth-web-server http-redirect
```

To re-enable the HTTP redirect feature, use the following commands:

```
awplus# configure terminal
awplus(config)# auth-web-server http-redirect
```

**Validation
Commands** `show auth-web`
`show auth-web-server`
`show running-config`

auth-web-server ipaddress

This command sets the IP address for the web authentication server.

Use the **no** variant of this command to delete the IP address for the web authentication server.

Syntax `auth-web-server ipaddress <ip-address>`
`no auth-web-server ipaddress`

Parameter	Description
<code><ip-address></code>	Web authentication server dotted decimal IP address in A.B.C.D format.

Default The web authentication server address on the system is not set by default.

Mode Global Configuration

Examples To set the IP address 10.0.0.1 to the web authentication server, use the following commands:

```
awplus# configure terminal
awplus(config)# auth-web-server ipaddress 10.0.0.1
```

To delete the IP address from the web authentication server, use the following commands:

```
awplus# configure terminal
awplus(config)# no auth-web-server ipaddress
```

Validation Commands `show auth-web`
`show auth-web-server`
`show running-config`

auth-web-server mode

Use this command with required keyword to configure an intercept mode (from the intercept, none, or promiscuous modes available) on the web authentication server for supplicants (client devices). The intercept modes available affect the interception of clients' ARPs and the proxy DNS response when using Web-authentication. These enhancements ensure that Web-authentication will proceed smoothly irrespective of the IP configuration on the client PC.

Use the **no** variant of this command to disable the intercept mode (either the intercept, none, or promiscuous intercept modes) configured on the web authentication server for supplicants.

Syntax `auth-web-server mode {intercept|none|promiscuous}`
`no auth-web-server mode {intercept|promiscuous}`

Parameter	Description
<code>intercept</code>	Selecting this parameter results in web authentication server on the switch intercepting and replying to ARP and DNS messages from the same interface and IP address.
<code>none</code>	Selecting this parameter disables the intercept mode on the web authentication server. No ARP and DNS messages are intercepted and replied to from the switch from any interfaces or from any IP addresses.
<code>promiscuous</code>	Selecting this parameter results in the web authentication server on the switch intercepting and replying to any ARP or DNS messages from any IP address.

Default Intercept mode on the web authentication server is set to **none** by default.

Mode Global Configuration

Usage See the section [“Web-authentication Enhancements” on page 56.9](#) in [Chapter 56, Authentication Configuration](#) for further overview information about the Web-authentication enhancements, allowing Web-authentication to work as seamlessly as 802.1X authentication.

See the sub-sections [“Interception of clients' ARPs” on page 56.9](#) and [“Proxy DNS response” on page 56.10](#) for an details of the associated usage of the available intercept modes.

See the section [“Limitations on allowed feature combinations” on page 56.12](#) for information about restrictions regarding combinations of authentication enhancements working together.

Examples To enable the intercept mode on the web authentication server, resulting in the switch intercepting and replying to ARP and DNS messages from the same interface and IP address, use the following commands:

```
awplus# configure terminal
awplus(config)# auth-web-server mode intercept
```

To disable the intercept mode on the web authentication server, use the following commands:

```
awplus# configure terminal
awplus(config)# no auth-web-server mode intercept
```

To reset the intercept mode to the default setting of none on the web authentication server, use the following commands:

```
awplus# configure terminal
awplus(config)# auth-web-server mode none
```

To enable the promiscuous mode on the web authentication server, resulting in the switch intercepting and replying to any ARP or DNS messages from any IP address, use the following commands:

```
awplus# configure terminal
awplus(config)# auth-web-server mode promiscuous
```

To disable the promiscuous mode on the web authentication server, use the following commands:

```
awplus# configure terminal
awplus(config)# no auth-web-server mode promiscuous
```

**Validation
Commands** `show running-config`

Related Commands `show auth-web-server`

auth-web-server ping-poll enable

This command enables the ping polling to the supplicant (client device) that is authenticated by web authentication.

The **no** variant of this command disables the ping polling to the supplicant that is authenticated by web authentication.

Syntax `auth-web-server ping-poll enable`
`no auth-web-server ping-poll enable`

Default The ping polling feature for web authentication is disabled by default.

Mode Global Configuration

Examples To enable the ping polling feature for web authentication, use the following commands:

```
awplus# configure terminal
awplus(config)# auth-web-server ping-poll enable
```

To disable the ping polling feature for web authentication, use the following commands:

```
awplus# configure terminal
awplus(config)# no auth-web-server ping-poll enable
```

**Validation
Commands** `show auth-web`
`show auth-web-server`
`show running-config`

auth-web-server ping-poll failcount

This command sets a fail count for the ping polling feature when used with web authentication. The **failcount** parameter specifies the number of unanswered pings. A supplicant (client device) is logged off when the number of unanswered pings are greater than the failcount set with this command.

Use the **no** variant of this command to resets the fail count for the ping polling feature to the default (5 pings).

Syntax `auth-web-server ping-poll failcount <1-100>`

`no auth-web-server ping-poll failcount`

Parameter	Description
<1-100>	Count.

Default The default failcount for ping polling is 5 pings.

Mode Global Configuration

Examples To set the failcount of ping polling to 10 pings, use the following commands:

```
awplus# configure terminal
```

```
awplus(config)# auth-web-server ping-poll failcount 10
```

To set the failcount of ping polling to default, use the following commands:

```
awplus# configure terminal
```

```
awplus(config)# no auth-web-server ping-poll failcount
```

**Validation
Commands** `show auth-web`
`show auth-web-server`
`show running-config`

auth-web-server ping-poll interval

This command is used to change the ping poll interval. The interval specifies the time period between pings when the supplicant (client device) is reachable.

Use the **no** variant of this command to reset to the default period for ping polling (30 seconds).

Syntax `auth-web-server ping-poll interval <1-65535>`
`no auth-web-server ping-poll interval`

Parameter	Description
<1-65535>	Seconds

Default The interval for ping polling is 30 seconds by default.

Mode Global Configuration

Examples To set the interval of ping polling to 60 seconds, use the following commands:

```
awplus# configure terminal
awplus(config)# auth-web-server ping-poll interval 60
```

To set the interval of ping polling to the default (30 seconds), use the following commands:

```
awplus# configure terminal
awplus(config)# no auth-web-server ping-poll interval
```

Validation Commands `show auth-web`
`show auth-web-server`
`show running-config`

auth-web-server ping-poll reauth-fresh

This command modifies the **reauth-fresh** parameter for the web-authentication feature. The **reauth-fresh** parameter specifies whether a re-authentication timer is reset and when the response from a supplicant (a client device) is received.

Use the **no** variant of this command to reset the **reauth-fresh** parameter to the default setting (disabled).

Syntax `auth-web-server ping-poll reauth-fresh`
`no auth-web-server ping-poll reauth-fresh`

Default The reauth-fresh parameter is disabled by default.

Mode Global Configuration

Examples To enable the **reauth-fresh** timer, use the following commands:

```
awplus# configure terminal
awplus(config)# auth-web-server ping-poll reauth-fresh
```

To disable the **reauth-fresh** timer, use the following commands:

```
awplus# configure terminal
awplus(config)# no auth-web-server ping-poll reauth-fresh
```

**Validation
Commands** `show auth-web`
`show auth-web-server`
`show running-config`

auth-web-server ping-poll timeout

This command modifies the ping poll **timeout** parameter for the web authentication feature. The **timeout** parameter specifies the time in seconds to wait for a response to a ping packet.

Use the **no** variant of this command to reset the timeout of ping polling to the default (1 second).

Syntax `auth-web-server ping-poll timeout <1-30>`
`no auth-web-server ping-poll timeout`

Parameter	Description
<1-30>	Seconds.

Default The default timeout for ping polling is 1 second.

Mode Global Configuration

Examples To set the timeout of ping polling to 2 seconds, use the command:

```
awplus# configure terminal
awplus(config)# auth-web-server ping-poll timeout 2
```

To set the timeout of ping polling to the default (1 second), use the command:

```
awplus# configure terminal
awplus(config)# no auth-web-server ping-poll timeout
```

Validation Commands `show auth-web`
`show auth-web-server`
`show running-config`

auth-web-server port

This command sets the HTTP port number for the web authentication server.

Use the **no** variant of this command to reset the HTTP port number to the default value (80).

Syntax `auth-web-server port <port-number>`

`no auth-web-server port`

Parameter	Description
<code><port-number></code>	Set the local web authentication server port within the TCP port number range 1 to 65535.

Default The web authentication server HTTP port number is set to 80 by default.

Mode Global Configuration

Examples To set the HTTP port number 8080 for the web authentication server, use the following commands:

```
awplus# configure terminal
awplus(config)# auth-web-server port 8080
```

To reset to the default HTTP port number 80 for the web authentication server, use the following commands:

```
awplus# configure terminal
awplus(config)# no auth-web-server port
```

**Validation
Commands** `show auth-web`
`show auth-web-server`
`show running-config`

auth-web-server redirect-url

This command sets a URL for supplicant (client device) authentication. When a supplicant is authorized it will be automatically redirected to the specified URL. Note that if the http redirect feature is used then this command is ignored.

Use the **no** variant of this command to delete the URL string set previously.

Syntax `auth-web-server redirect-url <url>`
`no auth-web-server redirect-url`

Parameter	Description
<code><url></code>	URL (hostname or dotted IP notation).

Default The redirect URL for the web authentication server feature is not set by default (null).

Mode Global Configuration

Examples To enable and set redirect a URL string `www.alliedtelesis.com` for the web authentication server, use the following commands:

```
awplus# configure terminal
awplus(config)# auth-web-server redirect-url
                www.alliedtelesis.com
```

To delete a redirect URL string, use the following commands:

```
awplus# configure terminal
awplus(config)# no auth-web-server redirect-url
```

**Validation
Commands** `show auth-web`
`show auth-web-server`
`show running-config`

Related Commands `auth-web-server http-redirect`

auth-web-server session-keep

This command enables the session-keep feature to jump to the original URL after being authorized by web authentication.

Use the **no** variant of this command to disable the session keep feature.

Syntax `auth-web-server session-keep`
`no auth-web-server session-keep`

Default The session-keep feature is disabled by default.

Mode Global Configuration

Examples To enable the session-keep feature, use the following commands:

```
awplus# configure terminal
awplus(config)# auth-web-server session-keep
```

To disable the session-keep feature, use the following commands:

```
awplus# configure terminal
awplus(config)# no auth-web-server session-keep
```

**Validation
Commands** `show auth-web`
`show auth-web-server`
`show running-config`

auth-web-server ssl

This command enables HTTPS functionality for the web authentication server feature.

Use the **no** variant of this command to disable HTTPS functionality for the web authentication server.

Syntax `auth-web-server ssl`
`no auth-web-server ssl`

Default HTTPS functionality for the web authentication server feature is disabled by default.

Mode Global Configuration

Examples To enable HTTPS functionality for the web authentication server feature, use the following commands:

```
awplus# configure terminal
awplus(config)# auth-web-server ssl
```

To disable HTTPS functionality for the web authentication server feature, use the following commands:

```
awplus# configure terminal
awplus(config)# no auth-web-server ssl
```

Validation Commands `show auth-web`
`show auth-web-server`
`show running-config`

auth-web-server sslport

This command sets the HTTPS port number for the web authentication server feature.

Use the **no** variant of this command to reset the HTTPS port number to the default port number (443) for the web authentication server feature.

Syntax `auth-web-server sslport <1-65535>`
`no auth-web-server sslport`

Parameter	Description
<code><1-65535></code>	Set the local web authentication server port within the TCP port number range 1 to 65535.

Default The HTTPS port number for the web authentication server feature is set to 443 by default.

Mode Global Configuration

Examples To set the HTTPS port number to 4433 for the web authentication server, use the command:

```
awplus# configure terminal
awplus(config)# auth-web-server sslport 4433
```

To reset the HTTPS port number for the web authentication server to the default (443), use the command:

```
awplus# configure terminal
awplus(config)# no auth-web-server sslport
```

Validation Commands `show auth-web`
`show auth-web-server`
`show running-config`

copy web-auth-https-file

Use this command to download the SSL server certificate for web-based authentication. The file must be in PEM (Privacy Enhanced Mail) format, and contain the private key and the server certificate.

Syntax `copy <filename> web-auth-https-file`

Parameter	Description
<code><filename></code>	The URL of the server certificate file.

Mode Privileged Exec

Example To download the server certificate file `verisign_cert.pem` from the TFTP server directory `server`, use the command:

```
awplus# copy tftp://server/verisign_cert.pem web-auth-https-file
```

Related Commands [auth-web-server ssl](#)
[erase web-auth-https-file](#)
[show auth-web-server](#)

erase web-auth-https-file

Use this command to remove the SSL server certificate for web-based authentication.

Syntax `erase web-auth-https-file`

Use this command to remove the SSL server certificate for web-based authentication.

Mode Privileged Exec

Example To remove the SSL server certificate file for web-based authentication use the command:

```
awplus# erase web-auth-https-file
```

Related Commands [auth-web-server ssl](#)
[copy web-auth-https-file](#)
[show auth-web-server](#)

show auth-mac

This command shows authentication information for MAC-based authentication.

Syntax `show auth-mac [all]`

Parameter	Description
all	Display all authentication information for each interface available on the switch.

Mode User Exec and Privileged Exec

Example To display all MAC based authentication information, enter the command:

```
awplus# show auth-mac all
```

Output Figure 57-1: Example output from the **show auth-mac** command

```
802.1X Port-Based Authentication Disabled
MAC-based Port Authentication Enabled
WEB-based Port Authentication Disabled
```

Related Commands [show dot1x](#)
[show auth-web](#)

show auth-mac diagnostics

This command shows MAC authentication diagnostics, optionally for the specified interface, which may be a static channel (or static aggregator) or a dynamic (or LACP) channel group or a switch port.

If no interface is specified then authentication diagnostics are shown for all interfaces.

Syntax `show auth-mac diagnostics [interface <interface-list>]`

Parameter	Description
interface	Specify an interface to show
<interface-list>	<p>The interfaces or ports to configure. An interface-list can be:</p> <ul style="list-style-type: none"> ■ an interface (e.g. <code>vlan2</code>), a switch port (e.g. <code>port1.1.12</code>), a static channel group (e.g. <code>sa3</code>) or a dynamic (LACP) channel group (e.g. <code>po4</code>) ■ a continuous range of interfaces, ports, static channel groups or dynamic (LACP) channel groups separated by a hyphen; e.g. <code>vlan2-8</code>, or <code>port1.1.1-1.1.24</code>, or <code>sa2-4</code>, or <code>po1-3</code> ■ a comma-separated list of the above; e.g. <code>port1.0.1,port1.1.1-1.2.24</code>. Do not mix interface types in a list. <p>The specified interfaces must exist.</p>

Mode User Exec and Privileged Exec

Example To display authentication diagnostics for `port1.0.12`, enter the command:

```
awplus# show auth-mac diagnostics interface port1.0.12
```

Output Figure 57-2: Example output from the `show auth-mac diagnostics` command

```
Authentication Diagnostics for interface port1.0.12
  Supplicant address: 00d0.59ab.7037
    authEnterConnecting: 2
    authEaplogoffWhileConnecting: 1
    authEnterAuthenticating: 2
    authSuccessWhileAuthenticating: 1
    authTimeoutWhileAuthenticating: 1
    authFailWhileAuthenticating: 0
    authEapstartWhileAuthenticating: 0
    authEaplogoggWhileAuthenticating: 0
    authReauthsWhileAuthenticated: 0
    authEapstartWhileAuthenticated: 0
    authEaplogoffWhileAuthenticated: 0
  BackendResponses: 2
  BackendAccessChallenges: 1
  BackendOtherrequestToSupplicant: 3
  BackendAuthSuccess: 1
```

show auth-mac interface

This command shows the status for MAC based authentication on the specified interface, which may be a static channel (or static aggregator) or a dynamic (or LACP) channel group or a switch port.

Use the optional **diagnostics** parameter to show authentication diagnostics for the specified interface. Use the optional **sessionstatistics** parameter to show authentication session statistics for the specified interface. Use the optional **statistics** parameter to show authentication diagnostics for the specified interface. Use the optional **supplicant** (client device) parameter to show the supplicant state for the specified interface.

Syntax `show auth-mac interface <interface-list>
[diagnostics|sessionstatistics|statistics|supplicant [brief]]`

Parameter	Description
<interface-list>	The interfaces or ports to configure. An interface-list can be: <ul style="list-style-type: none"> ■ an interface (e.g. <code>vlan2</code>), a switch port (e.g. <code>port1.1.12</code>), a static channel group (e.g. <code>sa3</code>) or a dynamic (LACP) channel group (e.g. <code>po4</code>) ■ a continuous range of interfaces, ports, static channel groups or dynamic (LACP) channel groups separated by a hyphen; e.g. <code>vlan2-8</code>, or <code>port1.1.1-1.1.24</code>, or <code>sa2-4</code>, or <code>po1-3</code> ■ a comma-separated list of the above; e.g. <code>port1.0.1,port1.1.1-1.2.24</code>. Do not mix interface types in a list. The specified interfaces must exist.
<code>diagnostics</code>	Diagnostics.
<code>sessionstatistics</code>	Session statistics.
<code>statistics</code>	Statistics.
<code>supplicant</code>	Supplicant (client device).
<code>brief</code>	Brief summary of supplicant state.

Mode User Exec and Privileged Exec

Examples To display MAC based authentication status for `port1.0.12`, enter the command:

```
awplus# show auth-mac interface port1.0.2
```

```
% Port-Control not configured on port1.0.2
```

To display MAC authentication diagnostics for `port1.0.12`, enter the command:

```
awplus# show auth-mac interface port1.0.12 diagnostics
```

```

Authentication Diagnostics for interface port1.0.12
  Supplicant address: 00d0.59ab.7037
    authEnterConnecting: 2
    authEaplogoffWhileConnecting: 1
    authEnterAuthenticating: 2
    authSuccessWhileAuthenticating: 1
    authTimeoutWhileAuthenticating: 1
    authFailWhileAuthenticating: 0
    authEapstartWhileAuthenticating: 0
    authEaplogoggWhileAuthenticating: 0
    authReauthsWhileAuthenticated: 0
    authEapstartWhileAuthenticated: 0
    authEaplogoffWhileAuthenticated: 0
    BackendResponses: 2
    BackendAccessChallenges: 1
    BackendOtherrequestToSupplicant: 3
    BackendAuthSuccess: 1
  
```

To display authentication session statistics for **port1.0.12**, enter the command:

```
awplus# show auth-mac interface port1.0.12 sessionstatistics
```

```

Authentication session statistics for interface port1.0.12
  session user name: manager
    session authentication method: Remote server
    session time: 19440 secs
    session terminat cause: Not terminated yet
  
```

To display MAC authentication statistics for **port1.0.12**, enter the command:

```
awplus# show auth-mac interface port1.0.12 statistics
```

To display the MAC authenticated supplicant on interface **port1.0.12**, enter the command:

```
awplus# show auth-mac interface port1.0.12 supplicant
```

Related Commands

- [show auth-web diagnostics](#)
- [show dot1x sessionstatistics](#)
- [show dot1x statistics interface](#)
- [show dot1x supplicant interface](#)

show auth-mac sessionstatistics

This command shows authentication session statistics for the specified interface, which may be a static channel (or static aggregator) or a dynamic (or LACP) channel group or a switch port.

Syntax `show auth-mac sessionstatistics [interface <interface-list>]`

Parameter	Description
<code>interface</code>	Specify an interface to show.
<code><interface-list></code>	<p>The interfaces or ports to configure. An interface-list can be:</p> <ul style="list-style-type: none"> ■ an interface (e.g. <code>vlan2</code>), a switch port (e.g. <code>port1.1.12</code>), a static channel group (e.g. <code>sa3</code>) or a dynamic (LACP) channel group (e.g. <code>po4</code>) ■ a continuous range of interfaces, ports, static channel groups or dynamic (LACP) channel groups separated by a hyphen; e.g. <code>vlan2-8</code>, or <code>port1.1.1-1.1.24</code>, or <code>po1-3</code> ■ a comma-separated list of the above; e.g. <code>port1.0.1, port1.1.1-1.2.24</code>. Do not mix interface types in a list. <p>The specified interfaces must exist.</p>

Mode User Exec and Privileged Exec

Example To display output displaying MAC authentication session statistics for `port1.0.12`, enter the command:

```
awplus# show auth-mac sessionstatistics interface port1.0.12
```

Output Figure 57-3: Example output from the `show auth-mac sessionstatistics` command

```
Authentication session statistics for interface port1.0.12
  session user name: manager
    session authentication method: Remote server
    session time: 19440 secs
    session terminat cause: Not terminated yet
```

show auth-mac statistics interface

This command shows the authentication statistics for the specified interface, which may be a static channel (or static aggregator) or a dynamic (or LACP) channel group or a switch port.

Syntax `show auth-mac statistics [interface <interface-list>]`

Parameter	Description
<code>interface</code>	Specify ports to show.
<code><interface-list></code>	The interfaces or ports to configure. An interface-list can be: <ul style="list-style-type: none"> ■ an interface (e.g. <code>vlan2</code>), a switch port (e.g. <code>port1.1.12</code>), a static channel group (e.g. <code>sa3</code>) or a dynamic (LACP) channel group (e.g. <code>po4</code>) ■ a continuous range of interfaces, ports, static channel groups or dynamic (LACP) channel groups separated by a hyphen; e.g. <code>vlan2-8</code>, or <code>port1.1.1-1.1.24</code>, or <code>sa2-4</code>, or <code>po1-3</code> ■ a comma-separated list of the above; e.g. <code>port1.0.1,port1.1.1-1.2.24</code>. Do not mix interface types in a list. The specified interfaces must exist.

Mode User Exec and Privileged Exec

Example To display MAC authentication statistics for `port1.0.12`, enter the command:

```
awplus# show auth-mac statistics interface port1.0.12
```

Related Commands [show dot1x interface](#)

show auth-mac supplicant

This command shows the supplicant (client device) state when MAC authentication is configured for the switch. This command shows a summary when the optional **brief** parameter is used.

Syntax `show auth-mac supplicant [<macadd>] [brief]`

Parameter	Description
<macadd>	Mac (hardware) address of the Supplicant Entry format is HHHH.HHHH.HHHH (hexadecimal).
brief	Brief summary of the Supplicant state.

Mode User Exec and Privileged Exec

Example To display the MAC authenticated supplicant for MAC address **00d0.59ab.7037**, enter the command:

```
awplus# show auth-mac supplicant 00d0.59ab.7037
```

show auth-mac supplicant interface

This command shows the supplicant (client device) state for the MAC authenticated interface, which may be a static channel (or static aggregator) or a dynamic (or LACP) channel group or a switch port. This command shows a summary when the optional **brief** parameter is used.

Syntax `show auth-mac supplicant [interface <interface-list>] [brief]`

Parameter	Description
<code>interface</code>	Specify ports to show.
<code><interface-list></code>	<p>The interfaces or ports to configure. An interface-list can be:</p> <ul style="list-style-type: none"> ■ an interface (e.g. <code>vlan2</code>), a switch port (e.g. <code>port1.1.12</code>), a static channel group (e.g. <code>sa3</code>) or a dynamic (LACP) channel group (e.g. <code>po4</code>) ■ a continuous range of interfaces, ports, static channel groups or dynamic (LACP) channel groups separated by a hyphen; e.g. <code>vlan2-8</code>, or <code>port1.1.1-1.1.24</code>, or <code>sa2-4</code>, or <code>po1-3</code> ■ a comma-separated list of the above; e.g. <code>port1.0.1, port1.1.1-1.2.24</code>. Do not mix interface types in a list. <p>The specified interfaces must exist.</p>
<code>brief</code>	Brief summary of the supplicant state.

Mode User Exec and Privileged Exec

Examples To display the MAC authenticated supplicant on the interface `port1.0.12`, enter the command:

```
awplus# show auth-mac supplicant interface port1.0.12
```

To display brief summary output for the MAC authenticated supplicant, enter the command:

```
awplus# show auth-mac supplicant brief
```

show auth-web

This command shows authentication information for Web-based authentication.

Syntax `show auth-web [all]`

Parameter	Description
all	Display all authentication information for each authenticated interface, which may be a static channel (or static aggregator) or a dynamic (or LACP) channel group or a switch port, available on the switch.

Mode User Exec and Privileged Exec

Example To display all Web authentication information, enter the command:

```
awplus# show auth-web all
```

Output Figure 57-4: Example output from the `show auth-web` command

```
802.1X Port-Based Authentication Disabled
MAC-based Port Authentication Disabled
WEB-based Port Authentication Enabled
```

Related Commands `show dot1x`
`show auth-mac`

show auth-web diagnostics

This command shows Web authentication diagnostics, optionally for the specified interface, which may be a static channel (or static aggregator) or a dynamic (or LACP) channel group or a switch port.

If no interface is specified then authentication diagnostics are shown for all interfaces.

Syntax `show auth-web diagnostics [interface <interface-list>]`

Parameter	Description
<code>interface</code>	Specify ports to show.
<code><interface-list></code>	<p>The interfaces or ports to configure. An interface-list can be:</p> <ul style="list-style-type: none"> ■ an interface (e.g. <code>vlan2</code>), a switch port (e.g. <code>port1.1.12</code>), a static channel group (e.g. <code>sa3</code>) or a dynamic (LACP) channel group (e.g. <code>po4</code>) ■ a continuous range of interfaces, ports, static channel groups or dynamic (LACP) channel groups separated by a hyphen; e.g. <code>vlan2-8</code>, or <code>port1.1.1-1.1.24</code>, or <code>sa2-4</code>, or <code>po1-3</code> ■ a comma-separated list of the above; e.g. <code>port1.0.1, port1.1.1-1.2.24</code>. Do not mix interface types in a list. <p>The specified interfaces must exist.</p>

Mode User Exec and Privileged Exec

Example To display authentication diagnostics for `port1.0.12`, enter the command:

```
awplus# show auth-web diagnostics interface port1.0.12
```

Output Figure 57-5: Example output from the `show auth-web diagnostics` command

```
Authentication Diagnostics for interface port1.0.12
  Supplicant address: 00d0.59ab.7037
    authEnterConnecting: 2
    authEaplogoffWhileConnecting: 1
    authEnterAuthenticating: 2
    authSuccessWhileAuthenticating: 1
    authTimeoutWhileAuthenticating: 1
    authFailWhileAuthenticating: 0
    authEapstartWhileAuthenticating: 0
    authEaplogoggWhileAuthenticating: 0
    authReauthsWhileAuthenticated: 0
    authEapstartWhileAuthenticated: 0
    authEaplogoffWhileAuthenticated: 0
  BackendResponses: 2
  BackendAccessChallenges: 1
  BackendOtherrequestToSupplicant: 3
  BackendAuthSuccess: 1
```

Related Commands [show dot1x interface](#)

show auth-web interface

This command shows the status for Web based authentication on the specified interface, which may be a static channel (or static aggregator) or a dynamic (or LACP) channel group or a switch port.

Use the optional **diagnostics** parameter to show authentication diagnostics for the specified interface. Use the optional **sessionstatistics** parameter to show authentication session statistics for the specified interface. Use the optional **statistics** parameter to show authentication diagnostics for the specified interface. Use the optional **supplicant** (client device) parameter to show the supplicant state for the specified interface.

Syntax `show auth-web interface <interface-list>
[diagnostics|sessionstatistics|statistics|supplicant [brief]]`

Parameter	Description
<interface-list>	The interfaces or ports to configure. An interface-list can be: <ul style="list-style-type: none"> ■ an interface (e.g. <code>vlan2</code>), a switch port (e.g. <code>port1.1.12</code>), a static channel group (e.g. <code>sa3</code>) or a dynamic (LACP) channel group (e.g. <code>po4</code>) ■ a continuous range of interfaces, ports, static channel groups or dynamic (LACP) channel groups separated by a hyphen; e.g. <code>vlan2-8</code>, or <code>port1.1.1-1.1.24</code>, or <code>sa2-4</code>, or <code>po1-3</code> ■ a comma-separated list of the above; e.g. <code>port1.0.1, port1.1.1-1.2.24</code>. Do not mix interface types in a list. The specified interfaces must exist.
<code>diagnostics</code>	Diagnostics.
<code>sessionstatistics</code>	Session statistics.
<code>statistics</code>	Statistics.
<code>supplicant</code>	Supplicant (client device).
<code>brief</code>	Brief summary of supplicant state.

Mode User Exec and Privileged Exec

Example To display the Web based authentication status for `port1.0.12`, enter the command:

```
awplus# show auth-web interface port1.0.2
```

```
% Port-Control not configured on port1.0.2
```

To display Web authentication diagnostics for **port 1.0.12**, enter the command:

```
awplus# show auth-web interface port1.0.12 diagnostics
```

```
Authentication Diagnostics for interface port1.0.12
  Supplicant address: 00d0.59ab.7037
    authEnterConnecting: 2
    authEaplogoffWhileConnecting: 1
    authEnterAuthenticating: 2
    authSuccessWhileAuthenticating: 1
    authTimeoutWhileAuthenticating: 1
    authFailWhileAuthenticating: 0
    authEapstartWhileAuthenticating: 0
    authEaplogoggWhileAuthenticating: 0
    authReauthsWhileAuthenticated: 0
    authEapstartWhileAuthenticated: 0
    authEaplogoffWhileAuthenticated: 0
  BackendResponses: 2
  BackendAccessChallenges: 1
  BackendOtherrequestToSupplicant: 3
  BackendAuthSuccess: 1
```

To display Web authentication session statistics for **port1.0.12**, enter the command:

```
awplus# show auth-web interface port1.0.12 sessionstatistics
```

```
Authentication session statistics for interface port1.0.12
  session user name: manager
    session authentication method: Remote server
    session time: 19440 secs
    session terminat cause: Not terminated yet
```

To display Web authentication statistics for **port 1.0.12**, enter the command:

```
awplus# show auth-web statistics interface port1.0.12
```

To display the Web authenticated supplicant on interface **port1.0.12**, enter the command:

```
awplus# show auth-web interface port1.0.12 supplicant
```

Related Commands

- [show auth-web diagnostics](#)
- [show dot1x sessionstatistics](#)
- [show dot1x statistics interface](#)
- [show dot1x supplicant interface](#)

show auth-web sessionstatistics

This command shows authentication session statistics for the specified interface, which may be a static channel (or static aggregator) or a dynamic (or LACP) channel group or a switch port.

Syntax `show auth-web sessionstatistics [interface <interface-list>]`

Parameter	Description
<code>interface</code>	Specify ports to show.
<code><interface-list></code>	<p>The interfaces or ports to configure. An interface-list can be:</p> <ul style="list-style-type: none"> ■ an interface (e.g. <code>vlan2</code>), a switch port (e.g. <code>port1.1.12</code>), a static channel group (e.g. <code>sa3</code>) or a dynamic (LACP) channel group (e.g. <code>po4</code>) ■ a continuous range of interfaces, ports, static channel groups or dynamic (LACP) channel groups separated by a hyphen; e.g. <code>vlan2-8</code>, or <code>port1.1.1-1.1.24</code>, or <code>sa2-4</code>, or <code>po1-3</code> ■ a comma-separated list of the above; e.g. <code>port1.0.1,port1.1.1-1.2.24</code>. Do not mix interface types in a list. <p>The specified interfaces must exist.</p>

Mode User Exec and Privileged Exec

Example To display authentication statistics for `port 1.0.12`, enter the command:

```
awplus# show auth-web sessionstatistics interface port1.0.12
```

Output Figure 57-6: Example output from the `show auth-web sessionstatistics` command

```
Authentication session statistics for interface port1.0.12
  session user name: manager
  session authentication method: Remote server
  session time: 19440 secs
  session terminat cause: Not terminated yet
```

show auth-web statistics interface

This command shows the authentication statistics for the specified interface, which may be a static channel (or static aggregator) or a dynamic (or LACP) channel group or a switch port.

Syntax `show auth-web statistics interface <interface-list>`

Parameter	Description
<interface-list>	<p>The interfaces or ports to configure. An interface-list can be:</p> <ul style="list-style-type: none"> ■ an interface (e.g. <code>vlan2</code>), a switch port (e.g. <code>port1.1.12</code>), a static channel group (e.g. <code>sa3</code>) or a dynamic (LACP) channel group (e.g. <code>po4</code>) ■ a continuous range of interfaces, ports, static channel groups or dynamic (LACP) channel groups separated by a hyphen; e.g. <code>vlan2-8</code>, or <code>port1.1.1-1.1.24</code>, or <code>sa2-4</code>, or <code>po1-3</code> ■ a comma-separated list of the above; e.g. <code>port1.0.1, port1.1.1-1.2.24</code>. Do not mix interface types in a list. <p>The specified interfaces must exist.</p>

Mode User Exec and Privileged Exec

Example To display Web authentication statistics for `port1.0.12`, enter the command:

```
awplus# show dot1x statistics interface port1.0.12
```

Related Commands [show dot1x interface](#)

show auth-web supplicant

This command shows the supplicant (client device) state when Web authentication is configured for the switch. This command shows a summary when the optional **brief** parameter is used.

Syntax `show auth-web supplicant [<macadd>] [brief]`

Parameter	Description
<macadd>	Mac (hardware) address of the supplicant Entry format is HHHH.HHHH.HHHH (hexadecimal)
brief	Brief summary of the supplicant state

Mode User Exec and Privileged Exec

Examples To display Web authenticated supplicant information on the switch, enter the command:

```
awplus# show auth-web supplicant
```

To display brief summary output for the Web authenticated supplicant on the switch, enter the command:

```
awplus# show auth-web supplicant brief
```

show auth-web supplicant interface

This command shows the supplicant (client device) state for the Web authenticated interface, which may be a static channel (or static aggregator) or a dynamic (or LACP) channel group or a switch port. This command shows a summary when the optional **brief** parameter is used.

Syntax `show auth-web supplicant interface <interface-list> [brief]`

Parameter	Description
<code><interface-list></code>	<p>The interfaces or ports to configure. An interface-list can be:</p> <ul style="list-style-type: none"> ■ an interface (e.g. <code>vlan2</code>), a switch port (e.g. <code>port1.1.12</code>), a static channel group (e.g. <code>sa3</code>) or a dynamic (LACP) channel group (e.g. <code>po4</code>) ■ a continuous range of interfaces, ports, static channel groups or dynamic (LACP) channel groups separated by a hyphen; e.g. <code>vlan2-8</code>, or <code>port1.1.1-1.1.24</code>, or <code>sa2-4</code>, or <code>po1-3</code> ■ a comma-separated list of the above; e.g. <code>port1.0.1,port1.1.1-1.2.24</code>. Do not mix interface types in a list. <p>The specified interfaces must exist.</p>
<code>brief</code>	Brief summary of the supplicant state.

Mode User Exec and Privileged Exec

Examples To display the Web authenticated supplicant on the interface `port1.0.12`, enter the command:

```
awplus# show auth-web supplicant interface port1.0.12
```

To display brief summary output for the Web authenticated supplicant, enter the command:

```
awplus# show auth-web supplicant brief
```

show auth-web-server

This command shows the web authentication server configuration and status on the switch.

Syntax `show auth-web-server`

Mode User Exec and Privileged Exec

Example To display web authentication server configuration and status, enter the command:

```
awplus# show auth-web-server
```

Output Figure 57-7: Example output from the `show auth-web-server` command

```
Web authentication server
  Server status: enabled
  Server address: -
  HTTP Port No: 80
  Security: enabled
  Certification: default
  SSL Port No: 443
  Redirect URL:
  HTTP Redirect: disabled
  Session keep: disabled
  PingPolling: disable
  PingInterval: 30
  Timeout: 1
  FailCount: 5
  ReauthFresh: disabled
```

Related Commands

- `auth-web-server http-redirect`
- `auth-web-server ipaddress`
- `auth-web-server port`
- `auth-web-server redirect-url`
- `auth-web-server session-keep`
- `auth-web-server ssl`
- `auth-web-server sslport`

Chapter 58: AAA Introduction and Configuration



AAA Introduction.....	58.2
Available functions and server types.....	58.2
Server Groups and Method Lists.....	58.2
Configuring AAA Login Authentication.....	58.4
AAA Configuration Tasks.....	58.4
Sample Authentication Configurations.....	58.6
Sample 802.1X Authentication Configuration.....	58.6
Sample MAC Authentication Configuration.....	58.7
Sample Web-Authentication Configuration.....	58.8
Sample Tri-Authentication Configuration.....	58.9

AAA Introduction

AAA is the collective title for the three related functions of Authentication, Authorization and Accounting. These function can be applied in a variety of methods with a variety of servers. The purpose of the AAA commands is to map instances of the AAA functions to sets of servers.

The Authentication function can be performed in multiple contexts, such as authentication of users logging in at a console, or 802.1x authentication of devices connecting to Ethernet ports.

For each of these contexts, you may want to use different sets of servers for examining the proffered authentication credentials and deciding if they are valid. AAA Authentication commands enable you to specify which servers will be used for different types of authentication.

Available functions and server types

Authentication and Accounting functions are available.

Authentication is performed in the following contexts:

- Login authentication of user shell sessions on the console port, and via telnet/SSH
- 802.1x authentication of devices connecting to switch ports
- MAC authentication of devices connecting to switch ports
- Web-based authentication of devices connecting to switch ports

Accounting is performed in the following contexts

- Accounting of console login sessions
- Accounting of 802.1x-authenticated connections
- Accounting of MAC-authenticated connections
- Accounting of Web-authenticated connections

There are two types of servers that can be used:

- Local user database
- RADIUS servers

Server Groups and Method Lists

There are two constructs that underlie the structure of the AAA commands:

- Server groups are lists of RADIUS servers
- Method Lists are lists of server types

A server group is defined by the command `aaa group server`. This command puts you into Server Group configuration mode. Once in that mode you can add servers to the group by using the command `server auth-port`.

Any number of servers can be added to a group. Typically, you will add servers which have already been configured by the command `radius-server host`. If you add a server that has not yet been configured by the command `radius-server host`, you will receive a warning that the server has not yet been configured, but the command will be accepted.

There is one server group that is always present on the switch by default that cannot be removed. It is the group simply named **radius** that comprises all servers that have been configured using the command **radius-server host**. As soon as a server is configured by the command **radius-server host**, it is automatically a member of the server group **radius** and cannot be removed from it.

A method list defines the set of server types that you want to be used for authenticating a user/device, and the order in which you want the server types to be used.

- You may want the usernames proffered for logging in at the console to be checked for in the user database first then checked for on a group of RADIUS servers if not found in the user database. You can create a server list that specifies **local** followed by **group**.
- You may want to check the RADIUS servers first, and resort to the local user database if none of the RADIUS servers respond. You can create a server list that specifies **group** first, followed by **local**.

A method list defines the servers where authentication requests are sent. The first server listed is used to authenticate users; if that server fails then the next authentication server type in the method list is selected. This process continues until there is a successful authentication or until all server types fail.

Default Method Lists

For every authentication or accounting type, it is always possible to define a method list called **default**. For most of the authentication and accounting types, the only method list that can be defined is **default**.

As soon as the default method list is defined for a given authentication or accounting type, it is automatically applied as the method list to be used for any instance of that type of authentication or accounting, except for instances to which another named method list has been specifically applied.

Configuring AAA Login Authentication

To configure AAA authentication, create default or a named method list for different authentication types. In the case of login authentication, the named method lists are then applied to consoles or VTY lines.

AAA Configuration Tasks

There are three steps to define how a given accounting or authentication type will be applied to a given port or line:

- Create a server group using the `aaa group server radius` command
- Create a method list for the authentication or accounting type as required
- Apply that method list to the port or line as required

Step 1: Define a group of RADIUS Servers:

- Create a server group using the `aaa group server radius` command:

To create a RADIUS server group named `GROUP1` with hosts `192.168.1.1`, `192.168.2.1` and `192.168.3.1`, use the commands:

```
awplus(config)# aaa group server radius GROUP1

awplus(config-sg)# server 192.168.1.1 auth-port 1812 acct-
port 1813

awplus(config-sg)# server 192.168.2.1 auth-port 1812 acct-
port 1813

awplus(config-sg)# server 192.168.3.1 auth-port 1812 acct-
port 1813
```

Step 2: Specify the login authentication Method List:

- Create a method list for the authentication or accounting type as required:

To configure a user login authentication method list called `USERS` to use first the local user database and then the RADIUS server group `GROUP1` for user login authentication, use the following commands:

```
awplus# configure terminal

awplus(config)# aaa authentication login USERS local group
GROUP1
```

Step 3: Apply Method List to Interface Port or Line:

- Apply that method list to the port or line as required:

```
awplus# configure terminal

awplus(config)# line console 0

awplus(config-line)# login authentication USERS
```

For most Authentication and Accounting types, the only possible server list is **default**, and the only server that can be put into it is **radius**. You will typically use all RADIUS servers, so the **group radius** can be used, rather than having to create a specific user group. Often the configuration of a given Authentication or Accounting type will consist of a single command, the command that defines the default server list, which contains just one server.

AAA 802.1x Authentication Configuration:

- AAA 802.1x authentication will typically be configured with the following commands:

To enable 802.1x Authentication globally for all RADIUS servers, use the following commands:

```
awplus# configure terminal
awplus(config)# aaa authentication dot1x default group radius
```

Sample Authentication Configurations

Sample 802.1X Authentication Configuration

See the below sample configuration script for a sample 802.1X authentication configuration. Copy and paste then edit the sample 802.1X authentication configuration in your config file. See the [edit](#) command in the [Chapter 7, File Management Commands](#) for further information.

Output

Figure 58-1: Sample 802.1X Authentication Configuration

```
!
radius-server host 127.0.0.1 key awplus-local-radius-server
!
aaa authentication dot1x default group radius
!
radius-server local
server enable
nas 127.0.0.1 key awplus-local-radius-server
user guest password guest!
!
no spanning-tree rstp enable
!
interface port1.0.1
switchport
switchport mode access
dot1x port-control auto
!
interface vlan1
ip address 192.168.1.120/24
!
```

The 802.1X authentication feature needs the [aaa authentication dot1x](#) command and the [dot1x port-control](#) command configured on an interface. See [Chapter 59, AAA Commands](#) and [Chapter 55, 802.1X Commands](#) for command information to edit this configuration.

Local RADIUS Server has been configured to use 802.1X authentication in this sample configuration. See the [radius-server local](#) and [server enable](#) commands in [Chapter 63, Local RADIUS Server Commands](#) for command information to edit this sample configuration.

This sample configuration enables 802.1X authentication on interface `vlan1` with IP address `192.168.1.120`. Change the VLAN ID and IP address as required for your configuration.

Sample MAC Authentication Configuration

See the below sample configuration script for a sample MAC authentication configuration. Copy, paste, and edit the sample MAC authentication configuration in the config file. See the [edit](#) command in the [Chapter 7, File Management Commands](#) for further information.

Output

Figure 58-2: Sample MAC Authentication Configuration

```
!  
radius-server host 127.0.0.1 key awplus-local-radius-server  
!  
aaa authentication auth-mac default group radius  
!  
radius-server local  
server enable  
nas 127.0.0.1 key awplus-local-radius-server  
user 00-d0-59-ab-70-37 password 00-d0-59-ab-70-37  
!  
no spanning-tree rstp enable  
!  
interface port1.0.1  
switchport  
switchport mode access  
auth-mac enable  
!  
interface vlan1  
ip address 192.168.1.120/24  
!
```

The MAC authentication feature needs the [aaa authentication auth-mac](#) and the [auth-mac enable](#) commands configured on an interface. See [Chapter 59, AAA Commands](#) and [Chapter 57, Authentication Commands](#) for command information to edit this configuration.

Local RADIUS Server has been configured to use MAC authentication in this sample configuration. See the [radius-server local](#) and [server enable](#) commands in [Chapter 63, Local RADIUS Server Commands](#) for command information to edit this sample configuration.

See the [user \(RADIUS server\)](#) command in [Chapter 63, Local RADIUS Server Commands](#) for command information to edit the MAC address of the supplicant for use with local RADIUS server as the RADIUS user name and the user password, as shown in the above configuration.

This configuration enables MAC authentication on `vlan1` with IP address `192.168.1.120`. Change the interface VLAN ID, MAC, and IP addresses as needed in your configuration.

Sample Web-Authentication Configuration

See the below sample configuration script for a sample Web-authentication configuration. Copy, paste, and edit the sample Web-authentication configuration for your config file. See the [edit](#) command in the [Chapter 7, File Management Commands](#) for further information.

Output

Figure 58-3: Sample Web-Authentication Configuration

```
!  
 radius-server host 127.0.0.1 key awplus-local-radius-server  
!  
 aaa authentication auth-web default group radius  
!  
 radius-server local  
 server enable  
 nas 127.0.0.1 key awplus-local-radius-server  
 user guest encrypted password  
 1+1WcLjLm29bCAXwWRPHXK0PF1sA7gNpR+P7wO4kwQQ=  
!  
 no spanning-tree rstp enable  
!  
 interface port1.0.1  
 switchport  
 switchport mode access  
 auth-web enable  
!  
 interface vlan1  
 ip address 192.168.1.120/24  
!
```

The Web-authentication feature needs the [aaa authentication auth-web](#) and the [auth-web enable](#) commands configured on an interface. See [Chapter 59, AAA Commands](#) and [Chapter 57, Authentication Commands](#) for command information to edit this configuration.

Local RADIUS Server has been configured to use Web-authentication in this sample configuration. See the [radius-server local](#) and [server enable](#) commands in [Chapter 63, Local RADIUS Server Commands](#) for command information to edit this sample configuration.

The above sample Web-authentication configuration requires the user name 'guest' with password 'guest!' on IP address 192.168.1.120 from interface port1.0.1.

Sample Tri-Authentication Configuration

See the below sample configuration script for a sample tri-authentication configuration that configures 802.1X authentication, MAC authentication, and Web-authentication on the same interface. Copy, paste, and edit the sample tri-authentication configuration for your config file. See the [edit](#) command in the [Chapter 7, File Management Commands](#) for further information.

Output

Figure 58-4: Sample Tri-Authentication Configuration

```
!  
radius-server host 127.0.0.1 key awplus-local-radius-server  
!  
aaa authentication dot1x default group radius  
aaa authentication auth-mac default group radius  
aaa authentication auth-web default group radius  
!  
radius-server local  
server enable  
nas 127.0.0.1 key awplus-local-radius-server  
user guest password guest!  
user 00-d0-59-ab-70-37 password 00-d0-59-ab-70-37  
!  
no spanning-tree rstp enable  
!  
interface port1.0.1  
switchport  
switchport mode access  
dot1x port-control auto  
auth-mac enable  
auth-web enable  
!  
interface vlan1  
ip address 192.168.1.120/24  
!
```

The 802.1X authentication feature needs the [aaa authentication dot1x](#) command and the [dot1x port-control](#) command configured on an interface. See [Chapter 59, AAA Commands](#) and [Chapter 55, 802.1X Commands](#) for command information to edit this configuration.

The MAC authentication feature needs the [aaa authentication auth-mac](#) and the [auth-mac enable](#) commands configured on an interface. See [Chapter 59, AAA Commands](#) and [Chapter 57, Authentication Commands](#) for command information to edit this configuration.

The Web-authentication feature needs the [aaa authentication auth-web](#) and the [auth-web enable](#) commands configured on an interface. See [Chapter 59, AAA Commands](#) and [Chapter 57, Authentication Commands](#) for command information to edit this configuration.

Local RADIUS Server has been configured to use tri-authentication in this sample configuration. See the [radius-server local](#) and [server enable](#) commands in [Chapter 63, Local RADIUS Server Commands](#) for command information to edit this sample configuration.

This sample tri-authentication configuration requires a user name 'guest' with password 'guest!' on IP address 192.168.1.120 from port1.0.1. Note this sample also configures 802.1X and MAC authentication on vlan1 with IP address 192.168.1.120. Change the interface VLAN ID, MAC and IP address as needed for your configuration.

Note that when tri-authentication is applied to the same interface then the order of execution is MAC authentication first, then 802.1X or Web-authentication, if MAC authentication fails.

Chapter 59: AAA Commands



Command List	59.2
aaa accounting auth-mac default	59.2
aaa accounting auth-web default	59.4
aaa accounting dot1x	59.6
aaa accounting login	59.8
aaa accounting update	59.10
aaa authentication auth-mac	59.11
aaa authentication auth-web	59.12
aaa authentication dot1x	59.13
aaa authentication login	59.14
aaa group server	59.16
aaa local authentication attempts lockout-time	59.17
aaa local authentication attempts max-fail	59.18
accounting login	59.19
clear aaa local user lockout	59.20
debug aaa	59.21
login authentication	59.22
show debugging aaa	59.23
undebug aaa	59.23

Command List

This chapter provides an alphabetical reference for AAA commands for Authentication, Authorization and Accounting. For more information, see [Chapter 58, AAA Introduction and Configuration](#).

aaa accounting auth-mac default

This command configures a default accounting method list for MAC-based Authentication. The default accounting method list specifies what type of accounting messages are sent and specifies which RADIUS Servers the accounting messages are sent to. The default accounting method list is automatically applied to interfaces with MAC-based Authentication enabled.

There are two ways to define servers where RADIUS accounting messages will be sent:

- **group radius** : use all RADIUS servers configured by radius-server host command
- **group <group-name>** : use the specified RADIUS server group

Configure the <group-name> using the [aaa group server](#) command. Configure the RADIUS server for **group radius** using the [radius-server host](#) command.

The accounting event to send to the RADIUS server is configured with the following options:

- **start-stop** : sends a **start** accounting message at the beginning of a session and a **stop** accounting message at the end of the session.
- **stop-only** : sends a **stop** accounting message at the end of a session.
- **none** : disables accounting.

Use the **no** variant of this command to disable AAA accounting for MAC-based Authentication globally.

Syntax

```
aaa accounting auth-mac default {start-stop|stop-only|none} group
    {<group-name>|radius}

no aaa accounting auth-mac default
```

Parameter	Description
start-stop	Start and stop records to be sent.
stop-only	Stop records to be sent.
none	No accounting record to be sent.
<group-name>	Server group name.
radius	Use all RADIUS servers

Default RADIUS accounting for MAC-based Authentication is disabled by default

Mode Global Configuration

Examples To enable RADIUS accounting for MAC-based Authentication, and use all available RADIUS Servers, use the commands:

```
awplus# configure terminal
awplus(config)# aaa accounting auth-mac default start-stop
group radius
```

To disable RADIUS accounting for MAC-based Authentication, use the commands:

```
awplus# configure terminal
awplus(config)# no aaa accounting auth-mac default
```

Related Commands [aaa authentication auth-mac](#)

aaa accounting auth-web default

This command configures a default accounting method list for Web-based Port Authentication. The default accounting method list specifies what type of accounting messages are sent and specifies which RADIUS Servers the accounting messages are sent to. The default accounting method list is automatically applied to interfaces with Web-based Authentication enabled.

There are two ways to define servers where RADIUS accounting messages will be sent:

- **group radius** : use all RADIUS servers configured by `radius-server host` command
- **group <group-name>** : use the specified RADIUS server group

Configure the `<group-name>` using the `aaa group server` command. Configure the RADIUS server for `group radius` using the `radius-server host` command.

Configure the accounting event to be sent to the RADIUS server with the following options:

- **start-stop** : sends a **start** accounting message at the beginning of a session and a **stop** accounting message at the end of the session.
- **stop-only** : sends a **stop** accounting message at the end of a session.
- **none** : disables accounting.

Use the **no** variant of this command to disable AAA accounting for Web-based Port Authentication globally.

Syntax

```
aaa accounting auth-web default {start-stop|stop-only|none}
    group {<group-name>|radius}

no aaa accounting auth-web default
```

Parameter	Description
<code>start-stop</code>	Start and stop records to be sent.
<code>stop-only</code>	Stop records to be sent.
<code>none</code>	No accounting record to be sent.
<code><group-name></code>	Server group name.
<code>radius</code>	Use all RADIUS servers.

Default RADIUS accounting for WEB-based Port Authentication is disabled by default.

Mode Global Configuration

Examples To enable RADIUS accounting for Web-based Authentication, and use all available RADIUS Servers, use the commands:

```
awplus# configure terminal
awplus(config)# aaa accounting auth-web default start-stop
group radius
```

To disable RADIUS accounting for Web-based Authentication, use the commands:

```
awplus# configure terminal
awplus(config)# no aaa accounting auth-web default
```

Related Commands [aaa authentication auth-web](#)

aaa accounting dot1x

This command configures the default accounting method list for IEEE 802.1x-based Authentication. The default accounting method list specifies what type of accounting messages are sent and specifies which RADIUS Servers the accounting messages are sent to. The default accounting method list is automatically applied to interfaces with IEEE 802.1x-based Authentication enabled.

There are two ways to define servers where RADIUS accounting messages will be sent:

- **group radius** : use all RADIUS servers configured by radius-server host command
- **group <group-name>** : use the specified RADIUS server group

Configure the **group-name** using the **aaa group server** command. Configure the RADIUS server for **group radius** using the **radius-server host** command.

The accounting event to send to the RADIUS server is configured by the following options:

- **start-stop** : sends a **start** accounting message at the beginning of a session and a **stop** accounting message at the end of the session.
- **stop-only** : sends a **stop** accounting message at the end of a session.
- **none** : disables accounting.

Use the **no** variant of this command to disable AAA accounting for 802.1x-based Port Authentication globally.

Syntax

```
aaa accounting dot1x default {start-stop|stop-only|none}
    group {<group-name>|radius}
no aaa accounting dot1x default
```

Parameter	Description
start-stop	Start and stop records to be sent.
stop-only	Stop records to be sent.
none	No accounting record to be sent.
<group-name>	Server group name.
radius	Use all RADIUS servers.

Default RADIUS accounting for 802.1X-based Port Authentication is disabled by default. (There is no default server set by default).

Mode Global Configuration

Usage Use this command to enable accounting on all switch ports with 802.1X enabled, and to specify which accounting messages to send and the ordered list of servers to use for accounting. Use the **no** variant of this command to remove the default accounting server for 802.1X. This disables 802.1X accounting.

Example To enable RADIUS accounting for 802.1x-based Authentication, and use all available RADIUS Servers, use the commands:

```
awplus# configure terminal
awplus(config)# aaa accounting dot1x default start-stop group
radius
```

To disable RADIUS accounting for 802.1x-based Authentication, use the commands:

```
awplus# configure terminal
awplus(config)# no aaa accounting dot1x default
```

Related Commands [aaa accounting update](#)
[aaa authentication dot1x](#)
[aaa group server](#)
[dot1x port-control](#)
[radius-server host](#)

aaa accounting login

This command configures RADIUS accounting for login shell sessions. The specified method list name can be used by the **accounting login** command in the Line Configuration mode. If the **default** parameter is specified, then this creates a default method list that is applied to every console and vty line, unless another accounting method list is applied on that line.

Use the **no** variant of this command to remove an accounting method list for login shell sessions configured by an **aaa accounting login** command. If the method list being deleted is already applied to a console or vty line, accounting on that line will be disabled. If the default method list name is removed by this command, it will disable accounting on every line that has the default accounting configuration.

Syntax

```
aaa accounting login {default|<list-name>}
    {start-stop|stop-only|none} {group {<group-name>|radius}}
```

```
no aaa accounting login {default|<list-name>}
```

Parameter	Description
<list-name>	Named accounting method list.
start-stop	Start and stop records to be sent.
stop-only	Stop records to be sent.
none	No accounting record to be sent.
<group-name>	Server group name.
radius	Use all RADIUS servers.

Usage This command enables you to define a named accounting method list. The items that you define in the accounting options are:

- the types of accounting packets that will be sent
- the set of servers to which the accounting packets will be sent

You can define a default method list the name `default`) and any number of other named method list. The `<list-name>` for any method list that you define can then be used as the `<list-name>` parameter in the **accounting login** command available from Line Configuration mode.

If the method list name already exists, the command will replace the existing configuration with the new one.

There are two ways to define servers where RADIUS accounting messages will be sent:

- **group radius** : use all RADIUS servers configured by `radius-server host` command
- **group *group-name*** : use the specified RADIUS server group

Configure the *group-name* using the `aaa group server` command. Configure the RADIUS server for **group radius** using the `radius-server host` command.

The accounting event to send to the RADIUS server is configured with the following options:

- **start-stop** : sends a **start** accounting message at the beginning of a session and a **stop** accounting message at the end of the session.
- **stop-only** : sends a **stop** accounting message at the end of a session.
- **none** : disables accounting.

Default RADIUS accounting is disabled by default for all login shell sessions.

Mode Global Configuration

Examples To configure RADIUS accounting for login shell sessions, use the following commands:

```
awplus# configure terminal
awplus(config)# aaa accounting login default start-stop group
radius
```

To reset the configuration of the default accounting list, use the following commands:

```
awplus# configure terminal
awplus(config)# no aaa accounting login default
```

Related Commands [aaa authentication login](#)
[aaa accounting login](#)
[accounting login](#)

aaa accounting update

This command enables periodic accounting reporting to the RADIUS accounting server(s) wherever RADIUS accounting has been configured.

When periodic accounting report is enabled, interim accounting records are sent periodically according to the specified interval in the **periodic** parameter. The default interval is 30 minutes.

Use the **no** variant of this command to disable periodic accounting reporting to the RADIUS accounting server(s).

Syntax `aaa accounting update [periodic <1-65535>]`

`no aaa accounting update`

Parameter	Description
<code>periodic</code>	Send accounting records periodically.
<code><1-65535></code>	Intervals to send accounting update (in minutes).

Default Periodic accounting update is disabled by default.

Mode Global Configuration

Usage Use this command to enable the device to send periodic AAA accounting reports to the accounting server. When periodic accounting updates are enabled, interim accounting records are sent periodically at the specified intervals. Use the **no** variant of this command to disable periodic accounting updates to the accounting server.

Example To configure the switch to send period accounting updates every 10 minutes, use the following commands:

```
awplus# configure terminal
awplus(config)# aaa accounting update periodic 10
```

To disable periodic accounting update wherever RADIUS accounting has been configured, use the following commands:

```
awplus# configure terminal
awplus(config)# no aaa accounting update
```

Related Commands [aaa accounting auth-mac default](#)
[aaa accounting auth-web default](#)
[aaa accounting dot1x](#)

aaa authentication auth-mac

This command enables MAC-based Port Authentication globally and allows you to specify an authentication method list. It is automatically applied to every interface running MAC-based Port Authentication.

There are two ways to define servers where RADIUS authentication messages will be sent:

- **group radius** : use all RADIUS servers configured by `radius-server host` command
- **group *group-name*** : use the specified RADIUS server group

Configure the *group-name* using the `aaa group server` command. Configure the RADIUS server for **group radius** using the `radius-server host` command.

Use the **no** variant of this command to globally disable MAC-based Port Authentication.

Syntax `aaa authentication auth-mac default group {<group-name>|radius}`
`no aaa authentication auth-mac default`

Parameter	Description
<i><group-name></i>	Server group name.
radius	Use all RADIUS servers.

Default MAC-based Port Authentication is disabled by default.

Mode Global Configuration

Usage A RADIUS Server is configured using the `radius-server host` command. All configured RADIUS Servers are automatically members of the server group radius.

Other named server groups are configured using the `aaa group server` command. If a server is added to a named group, it also remains a member of the group radius.

Example To enable MAC-based Port Authentication globally for all RADIUS servers, and use all available RADIUS servers, use the commands:

```
awplus# configure terminal
awplus(config)# aaa authentication auth-mac default group
radius
```

To disable MAC-based Port Authentication, use the commands:

```
awplus# configure terminal
awplus(config)# no aaa authentication auth-mac default
```

Related Commands `aaa accounting auth-mac default`
`auth-mac enable`

aaa authentication auth-web

This command enables Web-based Port Authentication globally and allows you to enable an authentication method list (in this case, a list of RADIUS Servers). It is automatically applied to every interface running Web-based Port Authentication.

There are two ways to define servers where RADIUS authentication messages will be sent:

- **group radius** : use all RADIUS servers configured by `radius-server host` command
- **group *group-name*** : use the specified RADIUS server group

Configure the *group-name* using the `aaa group server` command. Configure the RADIUS server for **group radius** using the `radius-server host` command.

Use the **no** variant of this command to globally disable Web-based Port Authentication.

Syntax `aaa authentication auth-web default group {<group-name>|radius}`
`no aaa authentication auth-web default`

Parameter	Description
<code><group-name></code>	Server group name.
<code>radius</code>	Use all RADIUS servers.

Default Web-based Port Authentication is disabled by default.

Mode Global Configuration

Example To enable Web-based Port Authentication globally for all RADIUS servers, and use all available RADIUS servers, use the commands:

```
awplus# configure terminal
awplus(config)# aaa authentication auth-web default group
radius
```

To disable Web-based Port Authentication, use the commands:

```
awplus# configure terminal
awplus(config)# no aaa authentication auth-web default
```

Related Commands `aaa accounting auth-web default`
`auth-mac enable`

aaa authentication dot1x

This command enables 802.1X-based Port Authentication globally and allows you to enable an authentication method list. It is automatically applied to every interface running 802.1X-based Port Authentication.

There are two ways to define servers where RADIUS authentication messages will be sent:

- **group radius** : use all RADIUS servers configured by `radius-server host` command
- **group group-name** : use the specified RADIUS server group

Configure the *group-name* using the `aaa group server` command. Configure the RADIUS server for **group radius** using the `radius-server host` command.

Use the **no** variant of this command to globally disable 802.1X-based Port Authentication.

Syntax `aaa authentication dot1x default group {<group-name>|radius}`
`no aaa authentication dot1x default`

Parameter	Description
<code>radius</code>	Use all RADIUS servers.
<code><group-name></code>	Server group name.

Default 802.1x-based Port Authentication is disabled by default.

Mode Global Configuration

Usage Use this command to specify the default method list to use for authentication on all switch ports with 802.1X enabled. Use the **no** variant of this command to reset the default authentication method list for 802.1X, to its default, that is, to use the group **radius**, containing all RADIUS servers configured by the `radius-server host` command.

Example To enable 802.1X-based Port Authentication globally with all RADIUS servers, and use all available RADIUS servers, use the command:

```
awplus# configure terminal
awplus(config)# aaa authentication dot1x default group radius
```

To disable 802.1X-based Port Authentication, use the command:

```
awplus# configure terminal
awplus(config)# no aaa authentication dot1x default
```

Related Commands `aaa accounting dot1x`
`aaa group server`
`dot1x port-control`
`radius-server host`

aaa authentication login

Use this command to create an ordered list of methods to use to authenticate user login, or to replace an existing method list with the same name. Specify one or more of the options **local** or **group**, in the order you want them to be applied. If the **default** method list name is specified, it is applied to every console and VTY line immediately unless another method list is applied to that line by the **login authentication** command. To apply a non-default method list, you must also use the **login authentication** command.

Use the **no** variant of this command to remove an authentication method list for user login. The specified method list name is deleted from the configuration. If the method list name has been applied to any console or VTY line, user login authentication on that line will fail.

Note that the **no aaa authentication login default** command does not remove the default method list. This will return the default method list to its default state (**local** is the default).

Syntax

```
aaa authentication login {default|<list-name>} [local]
    [group {radius|<group-name>}]
no aaa authentication login {default|<list-name>}
```

Parameter	Description
default	Set the default authentication server for user login.
<list-name>	Name of authentication server.
local	Use the local username database.
group	Use server group.
radius	Use all RADIUS servers configured by the radius-server host command on page 61.6 .
<group-name>	Use the specified RADIUS server group, as configured by the aaa group server command.

Default If the default server is not configured using this command, user login authentication uses the local user database only. If the **default** method list name is specified, it is applied to every console and VTY line immediately unless method list server is applied to that line by the **login authentication** command.

local is the default state for the default method list. Reset to the default method list using the **no aaa authentication login default** command.

Mode Global Configuration

Examples To configure the default authentication method list for user login to use all available RADIUS servers and then the local user database, use the following commands:

```
awplus# configure terminal
awplus(config)# aaa authentication login default group radius
local
```

To configure a user login authentication method list called `USERS` to use first the local user database and then the RADIUS server group `RAD_GROUP1` for user login authentication, use the following commands:

```
awplus# configure terminal
awplus(config)# aaa authentication login USERS local group
RAD_GROUP1
```

To return to the default method list (**local** is the default server), use the following commands:

```
awplus# configure terminal
awplus(config)# no aaa authentication login default
```

To delete an existing authentication method list `USERS` created for user login authentication, use the following commands:

```
awplus# configure terminal
awplus(config)# no aaa authentication login USERS
```

Related Commands [login authentication](#)

aaa group server

This command configures a RADIUS server group. A server group can be used to specify a subset of RADIUS servers in **aaa** commands. The group name **radius** is predefined, which includes all RADIUS servers configured by the **radius-server host** command.

RADIUS servers are added to a server group using the **server** command. Each RADIUS server should be configured using the **radius-server host** command.

Use the **no** variant of this command to remove an existing RADIUS server group.

Syntax `aaa group server radius <group-name>`

`no aaa group server`

Parameter	Description
<code><group-name></code>	Server group name.

Mode Global Configuration

Usage Use this command to create an AAA group of RADIUS servers, and to enter Server Group Configuration mode, in which you can add servers to the group. Use a server group to specify a subset of RADIUS servers in AAA commands. Each RADIUS server must be configured by the **radius-server host** command. To add RADIUS servers to a server group, use the **server** command.

Example To create a RADIUS server group named GROUP1 with hosts 192.168.1.1, 192.168.2.1 and 192.168.3.1, use the commands:

```
awplus(config)# aaa group server radius GROUP1
awplus(config-sg)# server 192.168.1.1 auth-port 1812 acct-
port 1813
awplus(config-sg)# server 192.168.2.1 auth-port 1812 acct-
port 1813
awplus(config-sg)# server 192.168.3.1 auth-port 1812 acct-
port 1813
```

To remove a RADIUS server group named GROUP1 from the configuration, use the command:

```
awplus(config)# no aaa group server radius GROUP1
```

Related Commands

- [aaa accounting auth-mac default](#)
- [aaa accounting auth-web default](#)
- [aaa accounting dot1x](#)
- [aaa accounting login](#)
- [aaa authentication auth-mac](#)
- [aaa authentication auth-web](#)
- [aaa authentication dot1x](#)
- [aaa authentication login](#)
- [radius-server host](#)
- [server \(Server Group\)](#)

aaa local authentication attempts lockout-time

This command configures the duration of the user lockout period.

Use the **no** variant of this command to restore the duration of the user lockout period to its default of 300 seconds (5 minutes).

Syntax `aaa local authentication attempts lockout-time <lockout-time>`
`no aaa local authentication attempts lockout-time`

Parameter	Description
<code><lockout-time></code>	<code><1-10000></code> . Time in seconds to lockout the user.

Mode Global Configuration

Default The default value for the lockout-time is 300 seconds (5 minutes).

Usage While locked out all attempts to login with the locked account will fail. The lockout can be manually cleared by another privileged account using the [clear aaa local user lockout](#) command.

Example To configure the lockout period to 10 minutes (600 seconds), use the commands:

```
awplus# configure terminal
awplus(config)# aaa local authentication attempts lockout-time
600
```

To restore the default lockout period of 5 minutes (300 seconds), use the commands:

```
awplus# configure terminal
awplus(config)# no aaa local authentication attempts
lockout-time
```

Related Commands [aaa local authentication attempts max-fail](#)

aaa local authentication attempts max-fail

This command configures the maximum number of failed login attempts before a user account is locked out. Every time a login attempt fails the failed login counter is incremented.

Use the **no** variant of this command to restore the maximum number of failed login attempts to the default setting (5 failed login attempts).

Syntax `aaa local authentication attempts max-fail <failed-logins>`
`no aaa local authentication attempts max-fail`

Parameter	Description
<code><failed-logins></code>	<code><1-32></code> . Number of login failures allowed before locking out a user.

Mode Global Configuration

Default The default value for the maximum number of failed login attempts is 5 failed login attempts.

Usage When the failed login counter reaches the limit configured by this command that user account is locked out for a specified duration configured by the [aaa local authentication attempts lockout-time](#) command.

When a successful login occurs the failed login counter is reset to 0. When a user account is locked out all attempts to login using that user account will fail.

Example To configure the number of login failures that will lock out a user account to 2 login attempts, use the commands:

```
awplus# configure terminal
```

```
awplus(config)# aaa local authentication attempts max-fail 2
```

To restore the number of login failures that will lock out a user account to the default number of login attempts (5 login attempts), use the commands:

```
awplus# configure terminal
```

```
awplus(config)# no aaa local authentication attempts max-fail
```

Related Commands [aaa local authentication attempts lockout-time](#)
[clear aaa local user lockout](#)

accounting login

This command applies a login accounting method list to console or vty lines for user login. When login accounting is enabled using the **aaa accounting login** command, logging events generate an accounting record to the accounting server configured using **aaa accounting login**.

The accounting method list must be configured first using the **aaa accounting login** command. If an accounting method list is specified that has not been created by the **aaa accounting login** command then accounting will be disabled on the specified lines.

The **no** variant of this command resets AAA (Authentication, Authorization, Accounting) Accounting applied to console or vty lines for local or remote login. **default** login accounting is applied after issuing the **no accounting login** command. Accounting is disabled with **default**.

Syntax `accounting login {default|<list-name>}`
`no accounting login`

Parameter	Description
<code>default</code>	Default accounting method list.
<code><list-name></code>	Named accounting method list.

Default By default login accounting is disabled in the **default** accounting server. No accounting will be performed until accounting is enabled using the **aaa accounting login** command beforehand.

Mode Line Configuration

Example To apply the accounting server `USERS` to all vty lines use the following commands:

```
awplus# configure terminal
awplus(config)# line vty 0 32
awplus(config-line)# accounting login USERS
```

To reset accounting for login sessions on the console, use the following commands:

```
awplus# configure terminal
awplus(config)# line console 0
awplus(config-line)# no accounting login
```

Related Commands [aaa accounting login](#)

clear aaa local user lockout

Use this command to clear the lockout on a specific user account or all user accounts.

Syntax `clear aaa local user lockout {username <username>|all}`

Parameter	Description
username	Clear lockout for the specified user.
<username>	Specifies the user account.
all	Clear lockout for all user accounts.

Mode Privileged Exec

Examples To unlock the user account 'bob' use the following command:

```
awplus# clear aaa local user lockout username bob
```

To unlock all user accounts use the following command:

```
awplus# clear aaa local user lockout all
```

Related Commands [aaa local authentication attempts lockout-time](#)

debug aaa

This command enables AAA debugging.

- If authentication is specified with `debug aaa`, debugging for AAA authentication is enabled.
- If accounting is specified with `debug aaa`, debugging for AAA accounting is enabled.
- If all is specified with `debug aaa`, all debugging options are enabled.
- If no option is specified with `debug aaa`, all debugging options are enabled.

Use the **no** variant of this command to disable AAA debugging.

- If authentication is specified with `no debug aaa`, debugging for AAA authentication is disabled.
- If accounting is specified with `no debug aaa`, debugging for AAA accounting is disabled.
- If all is specified with `no debug aaa`, all debugging options are disabled.
- If no option is specified with `no debug aaa`, all debugging options are disabled.

Syntax `debug aaa [accounting|all|authentication]`
`no debug aaa [accounting|all|authentication]`

Parameter	Description
<code>accounting</code>	Accounting.
<code>all</code>	Turn on all debugging.
<code>authentication</code>	Authentication.

Default AAA debugging is disabled by default.

Mode Privileged Exec

Example To enable authentication debugging for AAA, use the command:

```
awplus# debug aaa authentication
```

To disable authentication debugging for AAA, use the command:

```
awplus# no debug aaa authentication
```

Related Commands `show debugging aaa`
`undebug aaa`

login authentication

Use this command to apply an AAA server for authenticating user login attempts from a console or remote logins on these console or VTY lines. The authentication method list must be specified by the **aaa authentication login** command. If the method list has not been configured by the **aaa authentication login** command, login authentication will fail on these lines.

Use the **no** variant of this command to reset AAA Authentication configuration to use the default method list for login authentication on these console or VTY lines.

Command Syntax `login authentication {default|<list-name>}`

`no login authentication`

Parameter	Description
<code>default</code>	The default authentication method list. If the default method list has not been configured by the aaa authentication login command, the local user database is used for user login authentication.
<code><list-name></code>	Named authentication server.

Default The default login authentication method list, as specified by the **aaa authentication login** command, is used to authenticate user login. (If this has not been specified, the default is to use the local user database.)

Mode Line Configuration

Examples To apply the authentication method list called `CONSOLE` to the console, use the following commands:

```
awplus# configure terminal
awplus(config)# line console 0
awplus(config-line)# login authentication CONSOLE
```

To reset user authentication configuration on all VTY lines, use the following commands:

```
awplus# configure terminal
awplus(config)# line vty 0 32
awplus(config-line)# no login authentication
```

Related Commands [aaa authentication login](#)
[line](#)

show debugging aaa

This command displays the current debugging status for AAA (Authentication, Authorization, Accounting).

Syntax `show debugging aaa`

Mode Privileged Exec

Example To display the current debugging status of AAA, use the command:

```
awplus# show debug aaa
```

Output Figure 59-1: Example output from the `show debug aaa` command

```
AAA debugging status:
  Authentication debugging is on
  Accounting debugging is off
```

undebug aaa

This command applies the functionality of the [no debug aaa command on page 59.21](#).

Chapter 60: RADIUS Introduction and Configuration



Introduction.....	60.2
RADIUS Packets	60.3
RADIUS Attributes.....	60.4
RADIUS Security	60.5
RADIUS Proxy.....	60.6
RADIUS Accounting.....	60.7
RADIUS Configuration.....	60.8
Switch Configuration Tasks.....	60.8
Switch to RADIUS Server Communication.....	60.9
AAA Server Groups Configuration	60.11
RADIUS Configuration Examples.....	60.13
RADIUS Authentication	60.13
Single RADIUS Server Configuration.....	60.15
Multiple RADIUS Server Configuration.....	60.15
RADIUS Server Group Configuration.....	60.16
RADIUS Server Configuration using Server Groups.....	60.16

Introduction

The main purpose of RADIUS (Remote Authentication Dial In User Service) is to enable the authentication of network users stored in a database on a server known as a RADIUS Server.

When users connect to the network, the switch the users connect to can challenge the users for authentication, and pass on the authentication to the RADIUS server to check. Based on the result of the check against the database, the RADIUS Server informs the switch whether or not to allow the connected user access to the network.

A RADIUS Server can do more than allow or deny access to the network. A RADIUS Server can send back parameters to the connected users, such as an IP address for the user, or a VLAN for the user, or a privilege level for a session. RADIUS also provides an accounting service. Switches can inform the RADIUS Server how long a user has been connected to the network, and how much traffic the user has sent and received while connected to the network.

The original use for RADIUS was for the authentication of users dialling into an ISP (Internet Service Provider). A PPP (Point-to-Point Protocol) connection would be established between the remote client and the ISP's access switch. The ISP's access switch would receive the client's username and password using PAP (Password Authentication Protocol) or using CHAP (Challenge Handshake Authentication Protocol) and pass on the client's username and password to the RADIUS server to authenticate the client. The RADIUS Server's response to the authentication request would be sent back to the client as a PAP or CHAP allow or deny.

RADIUS has been adapted to network access authentication applications. Network access authentication using RADIUS follows a similar method to the PPP dial-up application for ISPs. For general network access authentication there is the RADIUS Server where the database of user authentication data is stored and a NAS (Network Access Server), which is the switch that user connects to first. The RADIUS Server and the NAS communicate with each other through exchanging attributes. Usernames and passwords are treated as attributes in RADIUS packets to and from a RADIUS Server and a NAS. The RADIUS Server is configured with a list of valid NASs that are allowed to send authentication requests to the RADIUS Server.

The RADIUS Server will not accept authentication requests from a NAS that is not on the list of valid NASs. Each NAS has a shared secret, which is a shared key with the RADIUS Server that is used to authenticate requests. The RADIUS Server has access to a list of user authentication data, stored within the RADIUS Server or accessed from another server.

Communication between the NAS and RADIUS Server uses the RADIUS protocol. The RADIUS protocol uses UDP packets. There are two UDP ports used as the destination port for RADIUS authentication packets (ports 1645 and 1812). Note that port 1812 is in more common use than port 1645 for authentication packets. UDP ports (ports 1646 and 1813) are used for RADIUS accounting separately from the ports used for RADIUS authentication.

Figure 60-1: Example showing a User to a NAS to a RADIUS Server network connection:

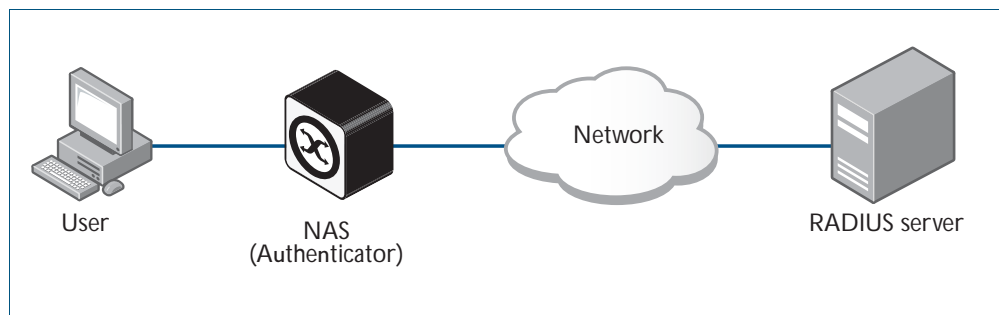

RADIUS Packets

The RADIUS RFCs define the RADIUS packet types and attributes. RADIUS authentication is defined by RFC2058, RFC2138, RFC2865, and RFC2868. RADIUS accounting is defined by RFC2059, RFC2139, RFC2866, and RFC2867. These RADIUS RFCs define over fifty attributes and six packets types (*Access-Request*, *Access-Accept*, *Access-Reject*, *Accounting-Request*, *Accounting-Response*, *Access-Challenge*).

A RADIUS exchange is initiated by the NAS when a user requests access to the NAS. The NAS obtains the user authentication data adds them into a RADIUS *Access-Request* packet type and sends the RADIUS *Access-Request* packet to the RADIUS Server.

- If a RADIUS Server has not been configured for authentication request from a NAS then it will silently discard an *Access-Request* packet from it.
- If the RADIUS Server accepts the request from the NAS it considers the authentication data provided in the *Access-Request* packet. The RADIUS Server may verify the user from its own database or it may connect to other servers to verify.
- If the RADIUS Server decides that the user is not allowed access to the NAS it responds to the NAS with an *Access-Reject* packet and the NAS will block the user.
- If the RADIUS Server decides that the user is valid but needs more information to verify that the user is not an imposter, it may send an *Access-Challenge* packet to the NAS that the NAS forwards to the user. The NAS forwards the user response to the *Access-Challenge* packet in an *Access-Request* packet to the RADIUS Server to accept or reject to allow or deny NAS user access.
- If the RADIUS Server rejects the user it sends an *Access-Reject* packet to the NAS.
- If the RADIUS Server accepts the user it sends an *Access-Accept* packet to the NAS. The *Access-Accept* packet to the NAS contains attributes that the NAS can apply.

Figure 60-2: Example showing an exchange from a Requestor to a NAS to a RADIUS Server

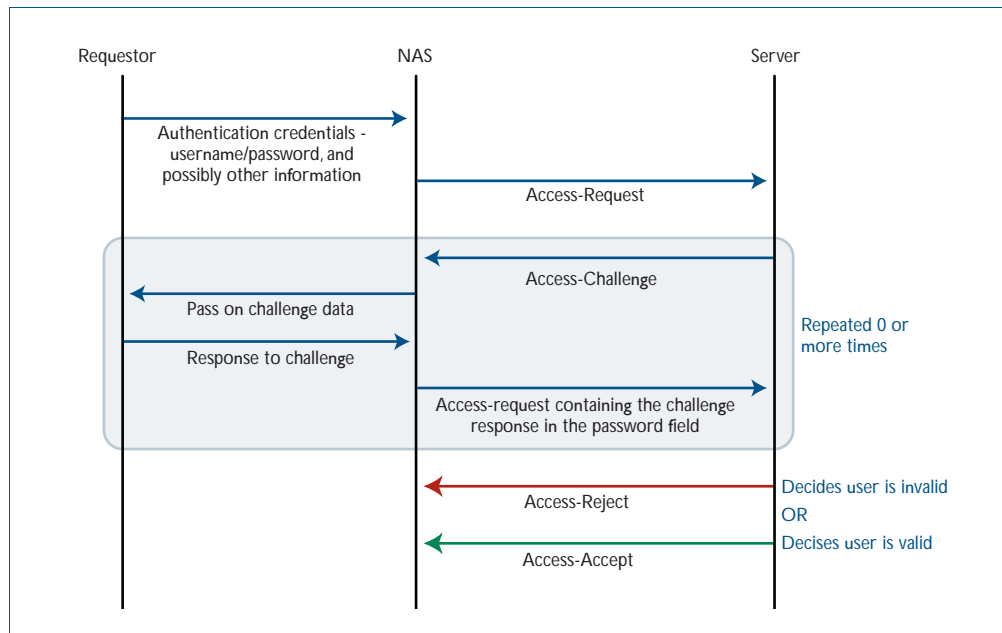

RADIUS Attributes

Each attribute is identified by its RFC-defined name, followed by its attribute ID in parenthesis.

- **User-name(1)**
User-names are strings of at least three characters and have a maximum of 253 characters, which is the the upper limit on all RADIUS attributes.
- **User-password(2)**
User-passwords are encrypted using an MD5 hash of the password, the NAS's shared secret with the RADIUS Server, and a request authenticator value. User-passwords can either be used at the initial authentication attempt or in response to an Access-Challenge packet type from the RADIUS Server to the NAS.
- **CHAP-password(3)**
CHAP-passwords are used if the NAS is using CHAP to authenticate the user, and doesn't receive the use the user's password but sends the CHAP response to the RADIUS Server instead. The CHAP password is an encrypted string that is an MD5 hash of the password and challenge value sent by the user.
- **Framed-IP-Address(8)**
Used for dial-in user making PPP connections to the NAS who are dynamically allocated an IP address that they can use for the duration of their connect. The RADIUS Server sends the Framed-IP-Address to the NAS to allocate.
- **Service-Type(6)**
Used when the NAS is authenticating a user who wants to open a management session on the NAS, and is sent by the RADIUS Server back to the NAS in an Access-Accept type packet to indicate the level of access the NAS gives a user. Service-Type(6) is mapped to a Privileged management session for AlliedWare Plus.
- **NAS-Port-Type(61)**
Identifies the type of port on which the user is accessing the NAS. The NAS-Port-Type(61) attribute is sent by the NAS to the RADIUS Server in Access-Request type packet, so the RADIUS Server may use it to choose access type. For 802.1X sessions, the NAS-Port-Type sent by the NAS is Ethernet (15).
- **802.1X VLAN assignment uses:**
Tunnel-Type(64), Tunnel-Medium-Type(65), Tunnel-Private-Group-ID(81), Egress-VLANID(56), and Egress-VLAN-Name(58) attributes (specified in RFC4675 used to specify 802.1Q tagged and untagged VLAN assignments with LLDP-MED/Voice-VLAN).

Attributes are carried within RADIUS packets in the form of TLVs (Type Length Values). Every attribute has an attribute ID number in the Type field of the TLV. The Length field holds a one-byte number that represents then length of the TLV. The Value field holds the value of the attribute.

Figure 60-3: Example showing TLVs in a RADIUS Packet from a NAS to a RADIUS Server

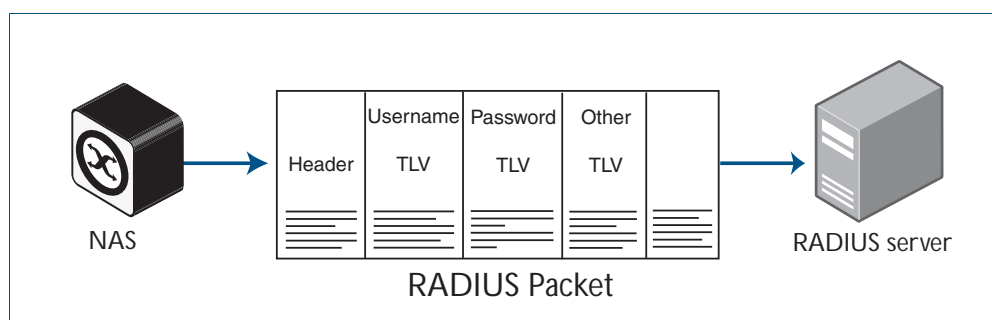

RADIUS Security

RADIUS is used for network security and carries user authentication information, so can be a target for security attacks. To counter threats there are three elements to RADIUS security:

1. Shared secret
2. Authenticator
3. Password Encryption

1. Shared Secret

Every NAS and server are configured with a pre-shared key, called the "shared secret", which is a key string, with no particular format of at least 16 characters.

The protocol has no method for choosing and sharing the secret between the NAS and the server. The secret must be manually generated and separately configured on the NAS and on the server.

The shared secret itself never appears in any RADIUS packets. It is used as an input to the algorithms used for creating encrypted values that are carried in the packets.

2. Authenticator

The authenticator is a random 16-byte value generated by the NAS. The NAS creates a new authenticator value for each `Access-Request` that it sends.

The response packets that come back from the server contain a value called the Response Authenticator. This is a value that is created by performing an MD5 hash on a string that is created by concatenating the packet type identifier, Session ID, Authenticator sent in the request packet, Attribute fields in the packet, Shared secret that the server shares with the NAS to which it is responding.

When the NAS receives the response packet, it performs the same hash on the same values, and verifies that it comes up with the same result. If not, then it must assume that the response packet has been spoofed, and silently discards it.

3. Password Encryption

The value placed in the user-password TLV of an `Access-Request` packet is not simply an exact copy of the password sent from the requestor to the NAS.

The NAS concatenates together the shared secret and the authenticator that it has randomly generated for this request and then performs manipulations (MD5, XOR) on that concatenation, and the password to create the value to go into password TLV.

When the server validates the `Access-Request`, it retrieves the user's password from the user credentials database, and performs the same manipulation upon that password. If the result matches the value in the user-password field of the `Access-Request`, then the password sent by the requestor is deemed to be correct.

RADIUS Proxy

The user database, which user credentials sent to a RADIUS server are looked up in, may not reside on the RADIUS server itself. The external user database may reside on another RADIUS server, and the communication to that server uses RADIUS. In the case where a RADIUS server communicates with a NAS, but also acts as a client to another RADIUS server, is said to be acting as a RADIUS proxy.

There are a variety of situations where RADIUS proxy is useful. Multiple RADIUS servers could have been set up, holding user databases for different purposes such as Authentication, Switch management sessions, Authenticating VPN connections, and Authenticating 802.1X sessions.

But it is convenient for there to be just one address that all the NASs in the network use as their RADIUS server. That one RADIUS server that the NASs send their requests to, can act as a proxy for all the servers holding the different user databases.

Figure 60-4: Example showing RADIUS Proxy

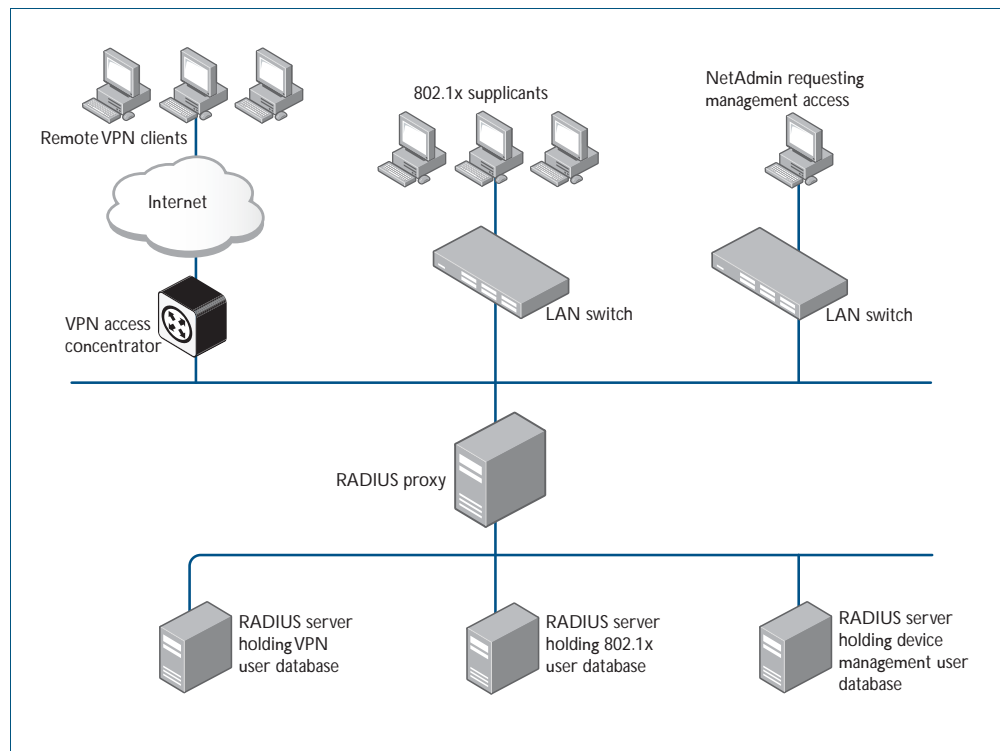

RADIUS Accounting

There are only two types of RADIUS accounting packet: `Accounting-Request` and `Accounting-Response`.

The `Accounting-Request` packets are always sent from the NAS to the server. The `Accounting-Response` packets are always sent from the server to the NAS, and are effectively ACKs of the `Accounting-Request` packets.

The `Accounting-Request` packets always carry the attribute `Acct-Status-Type`. The most commonly used values of this attribute are:

- **Start** – which denotes a packet marking that a session is beginning
- **Stop** – which denotes a packet marking that a session is ending
- **Interim update** – packets sent periodically during the session to give update reports on the statistics that are being collected.

The statistics that can be exchanged in the session are:

- **Input Octets**
- **Input Packets**
- **Output Octets**
- **Output Packets**
- **Session Duration**

There is no requirement to exchange all these statistics – NAS implementations are at liberty to choose which statistics they will send. Each of these statistics has a corresponding attribute type. The attributes are sent in Interim-Update and Stop accounting request packets.

Each accounting session has a unique session ID, which is chosen by the NAS. The session ID is carried in an `Acct-Session-Id` attribute, that should be present in every packet involved in the session. The accounting packets typically do not use the same UDP port as the authentication packets. The default port for RADIUS accounting is 1813.

Figure 60-5: Example showing RADIUS Accounting between a NAS and a RADIUS Server

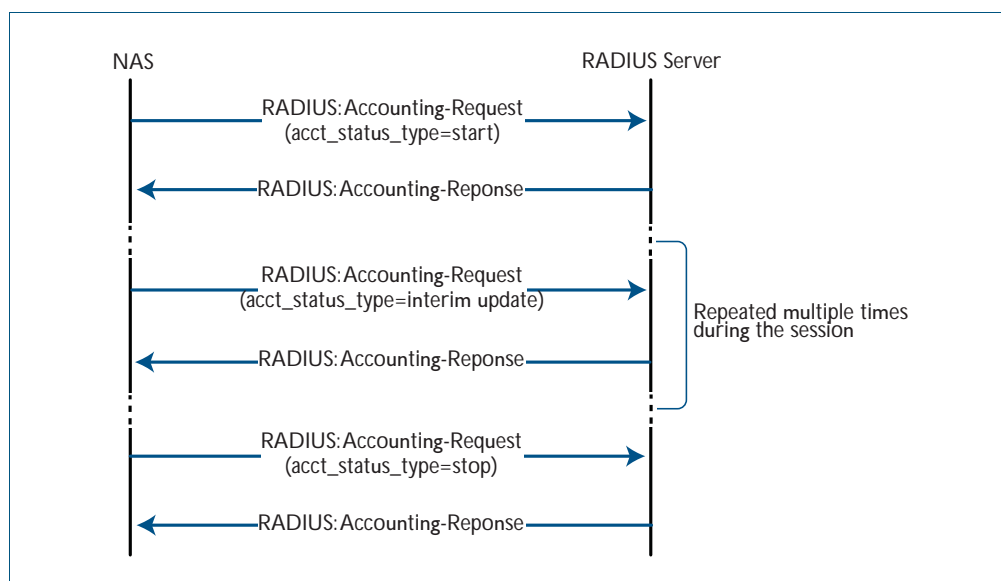

RADIUS Configuration

This section describes how to configure RADIUS with the available AAA commands. For a description of AAA commands, refer to the [AAA Commands](#) chapter. For a description of the RADIUS commands used, refer to the [RADIUS Commands](#) chapter.

RADIUS is often used in a variety of networks that need high security while maintaining access for remote users. RADIUS is suitable for the following networks that require access security:

- Networks with multiple-vendor access servers, each supporting RADIUS. For example, access servers from several vendors use a single RADIUS server-based security database.
- Networks in which a user may access a single service. Using RADIUS, you can control user access to a single host, or to a single utility such as Telnet.
- Networks that require accounting. You can use RADIUS accounting independent of RADIUS authentication. The RADIUS accounting functions allow data to be sent at the start and end of services, indicating the amount of resources (time, packets, bytes) used.

Switch Configuration Tasks

To configure RADIUS on your switch or access server, you must perform the following tasks:

- Use the **aaa authentication** command to define method lists for RADIUS authentication. For information about this command, refer to the [AAA Commands](#) chapter.
- Use authentication commands to enable the defined method lists to be used. For more information, refer to the [Authentication Commands](#) chapter.

The following configuration tasks are optional:

- You can use the **aaa group server** command to group selected RADIUS hosts for specific services. For detailed information about this command, refer to the [AAA Server Groups Configuration](#) section in this chapter and refer to the [AAA Commands](#) chapter.
- You can use the **aaa accounting login** command to enable accounting for RADIUS connections. For information about this command, refer to the [AAA Commands](#) chapter.

This section describes how to set up RADIUS for authentication and accounting on your network, and includes the following sections:

- Switch to RADIUS Server Communication (Required)
- Configuring AAA Server Groups (Optional)
- Configuring AAA Server Groups with Deadtime (Optional)
- Specifying RADIUS Authentication
- Specifying RADIUS Accounting (Optional)

For RADIUS configuration examples using the commands in this chapter, refer to the section [RADIUS Configuration Examples](#) at the end of this chapter.

Switch to RADIUS Server Communication

The RADIUS host is normally a multiuser system running RADIUS server software from a software provider. Switch to RADIUS server communication has several components:

- Host name or IP address
- Authentication destination port
- Accounting destination port
- Timeout period
- Retransmission value
- Key string

RADIUS security servers are identified on the basis of their host name or IP address, host name and specific UDP port numbers, or IP address and specific UDP port numbers. The combination of the IP address and UDP port number creates a unique identifier, allowing different ports to be individually defined as RADIUS hosts providing a specific AAA service. This unique identifier enables RADIUS requests to be sent to multiple UDP ports on a server at the same IP address.

A RADIUS server and a switch use a shared secret text string to encrypt passwords and exchange responses. To configure RADIUS using the AAA security commands, you must specify the host running the RADIUS server daemon and a secret text string that it shares with the switch, which you can specify using the **key** parameter in the `radius-server host` command.

The timeout, retransmission, and encryption key values are configurable globally for all RADIUS servers, on a per-server basis, or in some combination of global and per-server settings. To apply these settings globally to all RADIUS servers communicating with the switch, use the three global commands: `radius-server timeout`, `radius-server retransmit`, and `radius-server key`. To apply these values on a specific RADIUS server, use the `radius-server host` command.

Note: *You can configure both global and per-server timeout, retransmission, and key value commands simultaneously on the same Network Access Server.*

If both global and per-server functions are configured on a switch, the per-server timer, retransmission, and key value commands override global timer, retransmission, and key value commands.

To configure per-server RADIUS server communication, use the following command in the Global Configuration mode:

Mode and Command	Command Purpose
<pre>awplus(config)# radius-server host {<hostname> <ip-address>} [auth-port <port-number>] [acct-port <port-number>] [timeout <seconds>] [retransmit <retries>] [key <string>]</pre>	<p>Specifies the IP address or host name of the remote RADIUS server host and assigns authentication and accounting destination UDP port numbers.</p> <p>Use the <code>auth-port <port-number></code> option to configure a specific UDP port on this RADIUS server to be used solely for authentication.</p> <p>Use the <code>acct-port <port-number></code> option to configure a specific UDP port on this RADIUS server to be used solely for accounting.</p> <p>To configure the network access server to recognize more than one host entry associated with a single IP address, simply repeat this command as many times as necessary, making sure that each UDP port number is different.</p> <p>Set the timeout, retransmit, and encryption key values to use with the specific RADIUS host. If no timeout is set, the global value is used; otherwise, enter a value in the range 1 to 1000.</p> <p>If no retransmit value is set, the global value is used; otherwise enter a value in the range 1 to 1000. If no key string is specified, the global value is used.</p>

To configure global communication settings between the switch and a RADIUS server, use the following `radius-server` commands in the Global Configuration mode:

Mode and Command	Command Purpose
<pre>awplus(config)# radius-server key <key></pre>	Specifies the shared secret text string used between the switch and a RADIUS server (no default is set).
<pre>awplus(config)# radius-server retransmit <retries></pre>	Specifies how many times the switch transmits each RADIUS request to the RADIUS server before giving up (the default is 3).
<pre>awplus(config)# radius-server timeout <seconds></pre>	Specifies for how many seconds a switch waits for a reply to a RADIUS request before retransmitting the request.
<pre>awplus(config)# radius-server deadtime <minutes></pre>	Specifies for how many minutes a RADIUS server that is not responding to authentication requests is passed over by requests for RADIUS authentication.

AAA Server Groups Configuration

Configuring the switch to use AAA server groups provides a way to group existing server hosts. This allows you to select a subset of the configured server hosts and use them for a particular service. A server group is used in conjunction with a global server-host list. The server group lists the IP addresses of the selected server hosts.

Server groups also can include multiple host entries for the same server, as long as each entry has a unique identifier. The combination of an IP address and a UDP port number creates a unique identifier, allowing different ports to be individually defined as RADIUS hosts providing a specific AAA service.

To define a server host with a server group name, enter the following commands in the Global Configuration mode. The listed RADIUS server must exist in the Global Configuration mode:

Mode and Command	Command Purpose
<pre>awplus(config)# radius-server host {<hostname> <ip-address>} [auth-port <port-number>] [acct-port <port-number>] [timeout <seconds>] [retransmit <retries>] [key <string>]</pre>	<p>Specifies and defines the IP address of the server host before configuring the AAA server-group.</p> <p>Refer to the section Switch to RADIUS Server Communication of this chapter for more information on the radius-server host command.</p>
<pre>awplus(config-if)# aaa group server <group-name></pre>	<p>Defines the AAA server group with a group name.</p> <p>This command puts the switch in server group sub configuration mode.</p>
<pre>awplus(config-sg)# server {<hostname> <ip-address>} [auth-port <port-number>] [acct-port <port-number>]</pre>	<p>Associates a particular RADIUS server with the defined server group. Each security server is identified by its IP address and UDP port number.</p> <p>Repeat this step for each RADIUS server in the AAA server group.</p> <p>Each server in the group must be defined previously using the radius-server host command.</p>

Configuring AAA Server Groups with Deadtime

After you have configured a server host with a server name, you can use the `deadtime` (RADIUS server group) command to configure each server per server group. Configuring deadtime within a server group allows you to direct AAA traffic to separate groups of servers that have different operational characteristics.

Configuring `deadtime` is no longer limited to a global configuration. A separate timer has been attached to each server host in every server group. When a server is found to be unresponsive after numerous retransmissions and time-outs, the server is assumed to be dead. The timers attached to each server host in all server groups are triggered. In essence, the timers are checked and subsequent requests to a server, once it is assumed to be dead, are directed to alternate servers, if configured. When the network access server receives a reply from the server, it checks and stops all configured timers, if running, for that server in all server groups.

If the timer has expired, only the server to which the timer is attached is assumed to be alive. This becomes the only server that can be tried for later AAA requests using the server groups to which the timer belongs.

Note: *Since one server has different timers and may have different deadtime values configured in the server groups, the same server may in the future have different states, dead and alive, at the same time. To change the state of a server, you must start and stop all configured timers in all server groups.*

The size of the server group will be increased because of the addition of new timers and the deadtime attribute. The overall impact of the structure depends on the number and size of the server groups and how the servers are shared among server groups in a specific configuration.

To configure deadtime within a server group, use the following commands beginning in the Global Configuration mode:

Mode and Command	Command Purpose
<code>awplus(config)# aaa group server radius group1</code>	Defines a RADIUS type server group.
<code>awplus(config-sg)# deadtime 1</code>	Configures and defines a deadtime value in minutes.
<code>awplus(config-sg)# exit</code>	Exits server group configuration mode.

Specifying RADIUS Authentication

After you have identified the RADIUS server and defined the RADIUS authentication key, you must define method lists for RADIUS authentication. Because RADIUS authentication is facilitated through AAA, you must enter the `aaa authentication login` command, specifying RADIUS as the authentication method. For detailed `aaa authentication login` command information, refer to the [AAA Commands](#) chapter.

Specifying RADIUS Accounting

The AAA accounting feature enables you to track the services users are accessing as well as the amount of network resources they are consuming. Because RADIUS accounting is facilitated through AAA, you must issue the `aaa accounting login` command, specifying RADIUS as the accounting method. For detailed `aaa accounting login` command information, refer to the [AAA Commands](#) chapter.

Monitoring and Maintaining RADIUS

To monitor and maintain RADIUS, use the following commands in privileged EXEC mode:

Mode and Command	Command Purpose
<code>awplus# debug radius</code>	Displays information associated with RADIUS. For detailed <code>debug radius</code> command information, refer to the RADIUS Commands chapter.
<code>awplus# show radius statistics</code>	Displays the RADIUS statistics for accounting and authentication packets. For detailed <code>show radius statistics</code> command information, refer to the RADIUS Commands chapter.

RADIUS Configuration Examples

The following sections provide RADIUS configuration examples:

- [RADIUS Authentication](#)
- [Single RADIUS Server Configuration](#)
- [Multiple RADIUS Server Configuration](#)
- [RADIUS Server Group Configuration](#)
- [RADIUS Server Configuration using Server Groups](#)

RADIUS Authentication

Example The following example shows how to configure the switch to authenticate using RADIUS:

Figure 60-6: Sample RADIUS Authentication to configure the switch to authenticate users

```
!  
radius-server host 172.10.10.1  
radius-server key radiuspass  
username newuser password newpass  
aaa authentication login admin  
!
```

The lines in this example RADIUS authentication and accounting configuration are defined as follows:

- The **radius-server host** command defines the IP address of the RADIUS server host.
- The **radius-server key** command defines the shared secret text string between the network access server and the RADIUS server host.
- The **aaa authentication login** command defines a method list named **admin** for login authentication.

Example The following example shows how to configure the switch to authenticate logins using RADIUS:

Figure 60-7: Sample RADIUS Authentication to authenticate logins

```
!  
aaa authentication login radius-login group radius  
!
```

This sample RADIUS authentication configuration is defined as follows:

- The **aaa authentication login radius-login group radius** command configures the switch to use RADIUS for authentication at the login prompt.

Example The following example shows how to configure the authentication method to verify a username and password at login. In this example, if a username is entered at the username prompt, that username is used for authentication.

Figure 60-8: Sample RADIUS Authentication to verify a username and password

```
!  
aaa authentication login default group radius  
radius-server host 172.10.10.1 auth-port 1812 acct-port 1813  
!
```

The lines in this sample RADIUS authentication configuration are defined as follows:

- The **aaa authentication login default group radius** command specifies that the username and password are verified by RADIUS.
- The **radius-server host 172.10.10.1 auth-port 1812 acct-port 1813** command specifies the IP address of the RADIUS server host, the UDP destination port for authentication requests, and the UDP destination port for accounting requests.

Single RADIUS Server Configuration

Example The following example shows how to configure server-specific timeout, retransmit, and key values for the RADIUS server with IP address 172.2.2.2:

Figure 60-9: Single RADIUS Server sample configuration

```
!  
radius-server host 172.2.2.2 timeout 5 retransmit 5 key 10  
!
```

Multiple RADIUS Server Configuration

Example The following example shows how to configure two RADIUS servers with specific timeout, retransmit, and key values. The `radius-server retransmit` command changes the global retransmission value to 4 for all RADIUS servers. The `radius-server host` command configures specific timeout, retransmission, and key values for the RADIUS server hosts with IP addresses 172.2.2.2 and 172.1.1.1

Figure 60-10: Multiple RADIUS Server sample configuration

```
!  
! Enable and configure radius authentication and accounting  
! services on the switch:  
!  
aaa authentication login default group radius  
aaa accounting default start-stop group radius  
!  
! Change the retransmission value for all RADIUS servers:  
!  
radius-server retransmit 4  
!  
! Configure per-server specific timeout, retransmission, and  
! key values. Change the default auth-port and acct-port  
! values.  
!  
radius-server host 172.2.2.2 auth-port 1645 acct-port 1646  
timeout 3 retransmit 3 key radkey  
!  
! Configure per-server specific timeout and key values. This  
! server uses the global retransmission value.  
!  
radius-server host 172.1.1.1 timeout 6 key rad123  
!
```

RADIUS Server Group Configuration

Example The following example shows how to create server group `group2` with three RADIUS server members, each with the same IP address but with unique authentication and accounting ports:

Figure 60-11: RADIUS Server Group sample configuration using the same IP address

```
!
aaa group server radius group2
  server 172.1.1.1 auth-port 1645 acct-port 1646
  server 172.1.1.1 auth-port 1812 acct-port 1813
  server 172.1.1.1 auth-port 2000 acct-port 2001
!
```

RADIUS Server Configuration using Server Groups

The following example shows how to configure the network access server to recognize two different RADIUS server groups.

One of these groups, `group1`, has two different host entries on the same RADIUS server configured for the same services. The second host entry configured acts as fail over backup to the first one. Each group is individually configured for `deadtime`; `deadtime` for `group1` is one minute, and `deadtime` for `group2` is two minutes.

Figure 60-12: Multiple RADIUS Servers using Server Groups sample configuration

```
!
! The following command configures default RADIUS parameters:
!
aaa authentication login default group group1
!
! The following commands define the group1 RADIUS server group
! and associate servers with it and configures a deadtime of
! one minute:
!
aaa group server radius group1
  server 172.1.1.1 auth-port 1645 acct-port 1646
  server 172.2.2.2 auth-port 1812 acct-port 1813
  deadtime 1
!
! The following commands define the group2 RADIUS server group
! and associate servers with it and configures a deadtime of
! two minutes:
!
aaa group server radius group2
  server 172.2.2.2 auth-port 1812 acct-port 1813
  server 172.3.3.3 auth-port 2000 acct-port 2001
  deadtime 2
!
! The following commands configure the RADIUS attributes
! for each host entry associated with one of the defined
! server groups:
!
radius-server host 172.1.1.1 auth-port 1645 acct-port 1646
radius-server host 172.2.2.2 auth-port 1812 acct-port 1813
radius-server host 172.3.3.3 auth-port 2000 acct-port 2001
!
```

Chapter 61: RADIUS Commands



Command List	61.2
deadtime (RADIUS server group)	61.2
debug radius.....	61.3
ip radius source-interface	61.4
radius-server deadtime	61.5
radius-server host	61.6
radius-server key	61.10
radius-server retransmit	61.11
radius-server timeout.....	61.12
server (Server Group).....	61.14
show debugging radius.....	61.16
show radius	61.17
show radius statistics.....	61.19
undebug radius.....	61.19

Command List

This chapter provides an alphabetical reference for commands used to configure the device to use RADIUS servers.

deadtime (RADIUS server group)

Use this command to configure the **deadtime** parameter for the RADIUS server group. This command overrides the global dead-time configured by the [radius-server deadtime command on page 61.5](#). The configured deadtime is the time period in minutes to skip a RADIUS server for authentication or accounting requests if the server is "dead". Note that a RADIUS server is considered "dead" if there is no response from the server within a defined time period.

Use the **no** variant of this command to reset the deadtime configured for the RADIUS server group. If the global deadtime for RADIUS server is configured the value will be used for the servers in the group. The global deadtime for the RADIUS server is set to 0 minutes by default.

Syntax `deadtime <0-1440>`

`no deadtime`

Parameter	Description
<code><0-1440></code>	Amount of time in minutes.

Default The deadtime is set to 0 minutes by default.

Mode Server Group Configuration

Usage If the RADIUS server does not respond to a request packet, the packet is retransmitted the number of times configured for the **retransmit** parameter (after waiting for a **timeout** period to expire). The server is then marked "dead", and the time is recorded. The **deadtime** parameter configures the amount of time to skip a dead server; if a server is dead, no request message is sent to the server for the **deadtime** period.

Examples To configure the deadtime for 5 minutes for the RADIUS server group "GROUP1", use the command:

```
awplus(config)# aaa group server radius GROUP1
awplus(config-sg)# server 192.168.1.1
awplus(config-sg)# deadtime 5
```

To remove the deadtime configured for the RADIUS server group "GROUP1", use the command:

```
awplus(config)# aaa group server radius GROUP1
awplus(config-sg)# no deadtime
```

Related Commands [aaa group server](#)
[radius-server deadtime](#)

debug radius

This command enables RADIUS debugging. If no option is specified, all debugging options are enabled.

Use the **no** variant of this command to disable RADIUS debugging. If no option is specified, all debugging options are disabled.

Syntax `debug radius [packet|event|all]`
`no debug radius [packet|event|all]`

Parameter	Description
packet	Debugging for RADIUS packets is enabled or disabled.
event	Debugging for RADIUS events is enabled or disabled.
all	Enable or disable all debugging options.

Default RADIUS debugging is disabled by default.

Mode Privileged Exec

Examples To enable debugging for RADIUS packets, use the command:

```
awplus# debug radius packet
```

To enable debugging for RADIUS events, use the command:

```
awplus# debug radius event
```

To disable debugging for RADIUS packets, use the command:

```
awplus# no debug radius packet
```

To disable debugging for RADIUS events, use the command:

```
awplus# no debug radius event
```

Related Commands [show debugging radius](#)
[undebug radius](#)

ip radius source-interface

This command configures the source IP address of every outgoing RADIUS packet to use a specific IP address or the IP address of a specific interface. If the specified interface is down or there is no IP address on the interface, then the source IP address of outgoing RADIUS packets depends on the interface the packets leave.

Use the **no** variant of this command to remove the source interface configuration. The source IP address in outgoing RADIUS packets will be the IP address of the interface from which the packets are sent.

Syntax `ip radius source-interface {<interface>|<ip-address>}`
`no ip radius source-interface`

Parameter	Description
<interface>	Interface name.
<ip-address>	IP address in the dotted decimal format A.B.C.D.

Default Source IP address of outgoing RADIUS packets depends on the interface the packets leave.

Mode Global Configuration

Examples To configure all outgoing RADIUS packets to use the IP address of the interface "vlan1" for the source IP address, use the following commands:

```
awplus# configure terminal
awplus(config)# ip radius source-interface vlan1
```

To configure the source IP address of all outgoing RADIUS packets to use 192.168.1.10, use the following commands:

```
awplus# configure terminal
awplus(config)# ip radius source-interface 192.168.1.10
```

To reset the source interface configuration for all outgoing RADIUS packets, use the following commands:

```
awplus# configure terminal
awplus(config)# no ip radius source-interface
```

Related Commands [radius-server host](#)
[show radius statistics](#)

radius-server deadtime

Use this command to specify the global **deadtime** for all RADIUS servers. If a RADIUS server is considered dead, it is skipped for the specified deadtime. This command specifies for how many minutes a RADIUS server that is not responding to authentication requests is passed over by requests for RADIUS authentication.

Use the **no** variant of this command to reset the global deadtime to the default value of 0 seconds, so that RADIUS servers are not skipped even if they are dead.

Syntax `radius-server deadtime <minutes>`

`no radius-server deadtime`

Parameter	Description
<code><minutes></code>	RADIUS server deadtime in minutes in the range 0 to 1440 (24 hours).

Default The default RADIUS deadtime configured on the system is 0 seconds.

Mode Global Configuration

Usage The RADIUS client considers a RADIUS server to be dead if it fails to respond to a request after it has been retransmitted as often as specified globally by the `radius-server retransmit` command or for the server by the `radius-server host` command. To improve RADIUS response times when some servers may be unavailable, set a **deadtime** to skip dead servers.

Examples To set the dead time of the RADIUS server to 60 minutes, use the following commands:

```
awplus# configure terminal
awplus(config)# radius-server deadtime 60
```

To disable the dead time of the RADIUS server, use the following commands:

```
awplus# configure terminal
awplus(config)# no radius-server deadtime
```

Related Commands `deadtime (RADIUS server group)`
`radius-server host`
`radius-server retransmit`
`show radius statistics`

radius-server host

Use this command to specify a remote RADIUS server host for authentication or accounting, and to set server-specific parameters. The parameters specified with this command override the corresponding global parameters for RADIUS servers. This command specifies the IP address or host name of the remote RADIUS server host and assigns authentication and accounting destination UDP port numbers.

This command adds the RADIUS server address and sets parameters to the RADIUS server. The RADIUS server is added to the running configuration after you issue this command. If parameters are not set using this command then common system settings are applied.

Use the **no** variant of this command to remove the specified server host as a RADIUS authentication and/or accounting server and set the destination port to the default RADIUS server port number (1812).

Syntax

```
radius-server host {<host-name>|<ip-address>} [acct-port <0-65535>]
    [auth-port <0-65535>] [key <key-string>] [retransmit <0-100>]
    [timeout <1-1000>]

no radius-server host {<host-name>|<ip-address>}
    [acct-port <0-65535>] [auth-port <0-65535>]
```

Parameter	Description
<host-name>	Server host name. The DNS name of the RADIUS server host.
<ip-address>	The IP address of the RADIUS server host.
acct-port	Accounting port. Specifies the UDP destination port for RADIUS accounting requests. If 0 is specified, the server is not used for accounting. The default UDP port for accounting is 1813.
<0-65535>	UDP port number (Accounting port number is set to 1813 by default) Specifies the UDP destination port for RADIUS accounting requests. If 0 is specified, the host is not used for accounting.
auth-port	Authentication port. Specifies the UDP destination port for RADIUS authentication requests. If 0 is specified, the server is not used for authentication. The default UDP port for authentication is 1812.
<0-65535>	UDP port number (Authentication port number is set to 1812 by default) Specifies the UDP destination port for RADIUS authentication requests. If 0 is specified, the host is not used for authentication.
timeout	Specifies the amount of time to wait for a response from the server. If this parameter is not specified the global value configured by the radius-server timeout command is used.
<1-1000>	Time in seconds to wait for a server reply (timeout is set to 5 seconds by default) The time interval (in seconds) to wait for the RADIUS server to reply before retransmitting a request or considering the server dead. This setting overrides the global value set by the radius-server timeout command. If no timeout value is specified for this server, the global value is used.

Parameter (cont.)	Description (cont.)
<code>retransmit</code>	Specifies the number of retries before skip to the next server. If this parameter is not specified the global value configured by the radius-server retransmit command is used.
<code><0-100></code>	Maximum number of retries (maximum number of retries is set to 3 by default) The maximum number of times to resend a RADIUS request to the server, if it does not respond within the timeout interval, before considering it dead and skipping to the next RADIUS server. This setting overrides the global setting of the radius-server retransmit command. If no retransmit value is specified, the global value is used.
<code>key</code>	Set shared secret key with RADIUS servers
<code><key-string></code>	Shared key string applied Specifies the shared secret authentication or encryption key for all RADIUS communications between this device and the RADIUS server. This key must match the encryption used on the RADIUS daemon. All leading spaces are ignored, but spaces within and at the end of the string are used. If spaces are used in the string, do not enclose the string in quotation marks unless the quotation marks themselves are part of the key. This setting overrides the global setting of the radius-server key command. If no key value is specified, the global value is used.

Default The RADIUS client address is not configured (null) by default. No RADIUS server is configured.

Mode Global Configuration

Usage Multiple **radius-server host** commands can be used to specify multiple hosts. The software searches for hosts in the order they are specified. If no host-specific timeout, retransmit, or key values are specified, the global values apply to that host. If there are multiple RADIUS servers for this client, use this command multiple times—once to specify each server.

If you specify a host without specifying the auth port or the acct port, it will by default be configured for both authentication and accounting, using the default UDP ports. To set a host to be a RADIUS server for authentication requests only, set the **acct-port** parameter to 0; to set the host to be a RADIUS server for accounting requests only, set the **auth-port** parameter to 0.

A RADIUS server is identified by IP address, authentication port and accounting port. A single host can be configured multiple times with different authentication or accounting ports. All the RADIUS servers configured with this command are included in the predefined RADIUS server group **radius**, which may be used by AAA authentication, authorization and accounting commands. The client transmits (and retransmits, according to the **retransmit** and **timeout** parameters) RADIUS authentication or accounting requests to the servers in the order you specify them, until it gets a response.

Examples To add the RADIUS server 10.0.0.20, use the following commands:

```
awplus# configure terminal
awplus(config)# radius-server host 10.0.0.20
```

To set the secret key to **allied** on the RADIUS server 10.0.0.20, use the following commands:

```
awplus# configure terminal
awplus(config)# radius-server host 10.0.0.20 key allied
```

To delete the RADIUS server 10.0.0.20, use the following commands:

```
awplus# configure terminal
awplus(config)# no radius-server host 10.0.0.20
```

To configure **rad1.company.com** for authentication only, use the following commands:

```
awplus# configure terminal
awplus(config)# radius-server host rad1.company.com
acct-port 0
```

To remove the RADIUS server **rad1.company.com** configured for authentication only, use the following commands:

```
awplus# configure terminal
awplus(config)# no radius-server host rad1.company.com
acct-port 0
```

To configure **rad2.company.com** for accounting only, use the following commands:

```
awplus# configure terminal
awplus(config)# radius-server host rad2.company.com
auth-port 0
```

To configure 192.168.1.1 with authentication port 1000, accounting port 1001 and retransmit count 5, use the following commands:

```
awplus# configure terminal
awplus(config)# radius-server host 192.168.1.1 auth-port 1000
acct-port 1001 retransmit 5
```

Related Commands

- [aaa group server](#)
- [radius-server key](#)
- [radius-server retransmit](#)
- [radius-server timeout](#)
- [show radius statistics](#)

radius-server key

This command sets a global secret key for RADIUS authentication on the switch. The shared secret text string is used for RADIUS authentication between the switch and a RADIUS server.

Note that if no secret key is explicitly specified for a RADIUS server, the global secret key will be used for the shared secret for the server.

Use the **no** variant of this command to reset the secret key to the default value (null).

Syntax `radius-server key <key>`
`no radius-server key`

Parameter	Description
<key>	Shared secret among radius server and 802.1X client.

Default The RADIUS server secret key on the system is not set by default (null).

Mode Global Configuration

Usage Use this command to set the global secret key shared between this client and its RADIUS servers. If no secret key is specified for a particular RADIUS server using the **radius-server host** command, this global key is used.

After enabling AAA authentication with the **aaa authentication login** command, set the authentication and encryption key using the **radius-server key** command so the key entered matches the key used on the RADIUS server.

Examples To set the global secret key to **allied** for RADIUS server, use the following commands:

```
awplus# configure terminal
awplus(config)# radius-server key allied
```

To set the global secret key to **secret** for RADIUS server, use the following commands:

```
awplus# configure terminal
awplus(config)# radius-server key secret
```

To delete the global secret key for RADIUS server, use the following commands:

```
awplus# configure terminal
awplus(config)# no radius-server key
```

Related Commands [radius-server host](#)
[show radius statistics](#)

radius-server retransmit

This command sets the retransmit counter to use RADIUS authentication on the switch. This command specifies how many times the switch transmits each RADIUS request to the RADIUS server before giving up.

This command configures the **retransmit** parameter for RADIUS servers globally. If the **retransmit** parameter is not specified for a RADIUS server by the **radius-server host** command then the global configuration set by this command is used for the server instead.

Use the **no** variant of this command to reset the re-transmit counter to the default (3).

Syntax `radius-server retransmit <retries>`

`no radius-server retransmit`

Parameter	Description
<code><retries></code>	RADIUS server retries in the range <1-100> The number of times a request is resent to a RADIUS server that does not respond, before the server is considered dead and the next server is tried. If no retransmit value is specified for a particular RADIUS server using the radius-server host command, this global value is used.

Default The default RADIUS retransmit count on the switch is 3.

Mode Global Configuration

Examples To set the RADIUS **retransmit** count to 1, use the following commands:

```
awplus# configure terminal
awplus(config)# radius-server retransmit 1
```

To set the RADIUS **retransmit** count to the default (3), use the following commands:

```
awplus# configure terminal
awplus(config)# no radius-server retransmit
```

To configure the RADIUS **retransmit** count globally with 5, use the following commands:

```
awplus# configure terminal
awplus(config)# radius-server retransmit 5
```

To disable retransmission of requests to a RADIUS server, use the following commands:

```
awplus# configure terminal
awplus(config)# radius-server retransmit 0
```

Related Commands [radius-server deadtime](#)
[radius-server host](#)
[show radius statistics](#)

radius-server timeout

Use this command to specify the RADIUS global timeout value. This is how long the device waits for a reply to a RADIUS request before retransmitting the request, or considering the server to be dead. If no timeout is specified for the particular RADIUS server by the **radius-server host** command, it uses this global timeout value.

Note that this command configures the **timeout** parameter for RADIUS servers globally.

The **no** variant of this command resets the transmit timeout to the default (5 seconds).

Syntax `radius-server timeout <seconds>`

`no radius-server timeout`

Parameter	Description
<code><seconds></code>	RADIUS server timeout in secs in the range 1 to 1000. The global time in seconds to wait for a RADIUS server to reply to a request before retransmitting the request, or considering the server to be dead (depending on the radius-server retransmit command).

Default The default RADIUS transmit timeout on the system is 5 seconds.

Mode Global Configuration

Examples To globally set the device to wait 20 seconds before retransmitting a RADIUS request to unresponsive RADIUS servers, use the following commands:

```
awplus# configure terminal
awplus(config)# radius-server timeout 20
```

To set the RADIUS **timeout** parameter to 1 second, use the following commands:

```
awplus# configure terminal
awplus(config)# radius-server timeout 1
```

To set the RADIUS **timeout** parameter to the default (5 seconds), use the following commands:

```
awplus# configure terminal
awplus(config)# no radius-server timeout
```

To configure the RADIUS server **timeout** period globally with 3 seconds, use the following commands:

```
awplus# configure terminal
awplus(config)# radius-server timeout 3
```

To reset the global **timeout** period for RADIUS servers to the default, use the following command:

```
awplus# configure terminal
awplus(config)# no radius-server timeout
```

Related Commands radius-server deadtime
 radius-server host
 radius-server retransmit
 show radius statistics

server (Server Group)

This command adds a RADIUS server to a server group in Server-Group Configuration mode. The RADIUS server should be configured by the [radius-server host](#) command.

The server is appended to the server list of the group and the order of configuration determines the precedence of servers. If the server exists in the server group already, it will be removed before added as a new server.

The server is identified by IP address and authentication and accounting UDP port numbers. So a RADIUS server can have multiple entries in a group with different authentication and/or accounting UDP ports. The **auth-port** specifies the UDP destination port for authentication requests to the server. To disable authentication for the server, set **auth-port** to 0. If the authentication port is missing, the default port number is 1812. The **acct-port** specifies the UDP destination port for accounting requests to the server. To disable accounting for the server, set **acct-port** to 0. If the accounting port is missing, the default port number is 1812.

Use the **no** variant of this command to remove a RADIUS server from the server group.

Syntax

```
server {<hostname>|<ip-address>}
    [auth-port <0-65535>][acct-port <0-65535>]

no server {<hostname>|<ip-address>}
    [auth-port <0-65535>][acct-port <0-65535>]
```

Parameter	Description
<hostname>	Server host name
<ip-address>	Server IP address The server is identified by IP address, authentication and accounting UDP port numbers. So a RADIUS server can have multiple entries in a group with different authentication and/or accounting UDP ports.
auth-port	Authentication port The auth-port specifies the UDP destination port for authentication requests to the server. To disable authentication for the server, set auth-port to 0. If the authentication port is missing, the default port number is 1812.
<0-65535>	UDP port number (default: 1812)
acct-port	Accounting port The acct-port specifies the UDP destination port for accounting requests to the server. To disable accounting for the server, set acct-port to 0. If the accounting port is missing, the default port number is 1813.
<0-65535>	UDP port number (default: 1813)

Default The default Authentication port number is 1812 and the default Accounting port number is 1813.

Mode Server Group Configuration

Usage The RADIUS server to be added must be configured by the `radius-server host` command. In order to add or remove a server, the `auth-port` and `acct-port` parameters in this command must be the same as the corresponding parameters in the `radius-server host` command.

Examples To create a RADIUS server group RAD_AUTH1 for authentication, use the following commands:

```
awplus# configure terminal
awplus(config)# aaa group server radius RAD_AUTH1
awplus(config-sg)# server 192.168.1.1 acct-port 0
awplus(config-sg)# server 192.168.2.1 auth-port 1000 acct-
port 0
```

To create a RADIUS server group RAD_ACCT1 for accounting, use the following commands:

```
awplus# configure terminal
awplus(config)# aaa group server radius RAD_ACCT1
awplus(config-sg)# server 192.168.2.1 auth-port 0 acct-
port 1001
awplus(config-sg)# server 192.168.3.1 auth-port 0
```

To remove server 192.168.3.1 from the existing server group GROUP1, use the following commands:

```
awplus# configure terminal
awplus(config)# aaa group server radius GROUP1
awplus(config-sg)# no server 192.168.3.1
```

Related Commands

- [aaa accounting auth-mac default](#)
- [aaa accounting auth-web default](#)
- [aaa accounting dot1x](#)
- [aaa accounting login](#)
- [aaa authentication auth-mac](#)
- [aaa authentication auth-web](#)
- [aaa authentication login](#)
- [aaa group server](#)
- [radius-server host](#)

show debugging radius

This command displays the current debugging status for the RADIUS servers.

Syntax `show debugging radius`

Mode Privileged Exec

Example To display the current debugging status of RADIUS servers, use the command:

```
awplus# show debugging radius
```

Output Figure 61-1: Example output from the `show debugging radius` command

```
RADIUS debugging status:  
RADIUS event debugging is off  
RADIUS packet debugging is off
```

show radius

This command displays the current RADIUS server configuration and status.

Syntax show radius

Mode Privileged Exec

Example To display the current status of RADIUS servers, use the command:

```
awplus# show radius
```

Output Figure 61-2: Example output from the **show radius** command showing RADIUS servers

```
RADIUS Global Configuration
Source Interface : not configured
Secret Key : secret
Timeout : 5 sec
Retransmit Count : 3
Deadtime : 20 min
Server Host : 192.168.1.10
Authentication Port : 1812
Accounting Port : 1813
Secret Key : secret
Timeout : 3 sec
Retransmit Count : 2
Server Host : 192.168.1.11
Authentication Port : 1812
Accounting Port : not configured
Server Name/Auth Acct Auth Acct
IP Address Port Port Status Status
-----
192.168.1.10 1812 1813 Alive Alive
192.168.1.11 1812 N/A Alive N/A
```

Example See the sample output below showing RADIUS client status and RADIUS configuration:

```
awplus# show radius
```

Output Figure 61-3: Example output from the **show radius** command showing RADIUS client status

```
RADIUS global interface name: awplus
Secret key:
Timeout: 5
Retransmit count: 3
Deadtime: 0

Server Address: 150.87.18.89
Auth destination port: 1812
Accounting port: 1813
Secret key: swg
Timeout: 5
Retransmit count: 3
Deadtime: 0
show radius local-server group
```

Output Description

Output Parameter	Meaning
Source Interface	The interface name or IP address to be used for the source address of all outgoing RADIUS packets.
Secret Key	A shared secret key to a radius server.
Timeout	A time interval in seconds.
Retransmit Count	The number of retry count if a RADIUS server does not response.
Deadtime	A time interval in minutes to mark a RADIUS server as "dead".
Interim-Update	A time interval in minutes to send Interim-Update Accounting report.
Group Deadtime	The deadtime configured for RADIUS servers within a server group.
Server Host	The RADIUS server hostname or IP address.
Authentication Port	The destination UDP port for RADIUS authentication requests.
Accounting Port	The destination UDP port for RADIUS accounting requests.
Auth Status	<p>The status of the authentication port. The status ("dead", "error", or "alive") of the RADIUS authentication server and, if dead, how long it has been dead for.</p> <ul style="list-style-type: none"> • Alive: the server is alive. • Error: the service is not responding. • Dead: the service is detected as dead and it will not be used for deadtime period. The time displayed in the output shows the server is in dead status for that amount of time. • Unknown: the server is never used or the status is unknown.
Acct Status	<p>The status of the accounting port. The status ("dead", "error", or "alive") of the RADIUS accounting server and, if dead, how long it has been dead for.</p>

show radius statistics

This command shows the RADIUS client statistics for the switch.

Syntax `show radius statistics`

Mode Privileged Exec

Example See the sample output below showing RADIUS client statistics and RADIUS configuration:

```
awplus# show radius statistics
```

Output Figure 61-4: Example output from the `show radius statistics` command:

```
RADIUS statistics for Server: 150.87.18.89
Access-Request Tx : 5 - Retransmit : 0
Access-Accept Rx : 1 - Access-Reject Rx : 2
Access-Challenge Rx : 2
Unknown Type : 0 - Bad Authenticator: 0
Malformed Access-Resp: 0 - Wrong Identifier: 0
Bad Attribute : 0 - Packet Dropped : 0
TimeOut : 0 - Dead count : 0
Pending Request: 0
```

undebug radius

This command applies the functionality of the [no debug radius command on page 61.3](#).

Chapter 62: Local RADIUS Server Introduction and Configuration



Local RADIUS Server Introduction.....	62.2
Enable the Local RADIUS Server.....	62.2
Add the Local RADIUS Server as a RADIUS Server	62.3
Add authenticators to the list of authenticators.....	62.3
Configure the Local RADIUS Server User Database.....	62.4
Authenticating login sessions	62.4
Creating certificates for single users and all users.....	62.6
Defined RADIUS attributes list.....	62.7

Local RADIUS Server Introduction

Local RADIUS Server provides a user authentication service feature. This feature must be enabled on the switch, because it is disabled by default. For details of commands used to configure the local RADIUS server, see [Chapter 63, Local RADIUS Server Commands](#).

Enable the Local RADIUS Server

The Local RADIUS Server is disabled by default. Enter the following commands to enable the Local RADIUS Server:

```
awplus# configure terminal
awplus(config)# radius-server local
awplus(config-radsrv)# server enable
```

This will automatically initialize the internal Certificate Authority (CA) in the switch. It will also automatically create a server certificate and enrol the certificate with the Local CA by implicitly executing the following commands:

```
awplus(config)# crypto pki trustpoint local
awplus(config)# crypto pki enroll local
```

The `crypto pki trustpoint local` command declares the Local CA as the CA from which to obtain Certificates. The Local CA has been defined first so Certificates can be obtained from it. The `crypto pki enroll local` command obtains the system certificate from the Local CA.

The switch is automatically added to the list of authenticators that may send authentication requests to the Local RADIUS Server by implicitly executing the following commands:

```
awplus# configure terminal
awplus(config)# radius-server local
awplus(config-radsrv)# nas 127.0.0.1 key awplus-local-radius-server
```

Note  The key `awplus-local-radius-server` is a pre-defined component that can be used for internal exchanges between the switch's RADIUS client and its RADIUS server.

Add the Local RADIUS Server as a RADIUS Server

Although the switch is automatically defined as a NAS (Network Access Server) for the Local RADIUS Server, you must manually add the Local RADIUS Server to the server list defined for the Local RADIUS Client.

Use the following commands to add the Local RADIUS Server as a RADIUS Server. The Local RADIUS Client can then send authentication requests to its Local RADIUS Server:

```
awplus# configure terminal
awplus(config)# radius-server host 127.0.0.1 key awplus-local-
radius-server
```

Add authenticators to the list of authenticators

Authenticators can send authentication requests to the Local RADIUS Server.

Use the following commands to add other authenticators to the list of authenticators.

```
awplus# configure terminal
awplus(config)# radius-server local
awplus(config-radsrv)# nas <nas-ip-address> key <nas-keystring>
```

Configure the Local RADIUS Server User Database

Add users to the RADIUS user list without assigning VLANs

For entries that will be used to authenticate dot1x supplicants, but not assign them to a VLAN, the following commands will add users to the RADIUS user list:

```
awplus# configure terminal
awplus(config)# radius-server local
awplus(config-radsrv)# user <radius-user-name> password <user-
password>
```

Add users to the RADIUS user list and assign VLANs

Add users to the RADIUS user list, and define a VLAN ID that will be assigned to them

To add entries to be used to authenticate dot1x supplicants, and assign them to a VLAN, follow the two steps shown below:

Step 1: Create groups associated with the VLANs that will be allocated

Enter the following commands to create groups with the VLANs that will be allocated to them:

```
awplus# configure terminal
awplus(config)# radius-server local
awplus(config-radsrv)# group VLAN10Users
awplus(config-radsrv)# vlan 10
awplus(config-radsrv)# group VLAN11Users
awplus(config-radsrv)# vlan 11
```

Step 2: Add the users after creating groups

Add the users and refer to the relevant group in the command that creates the user as below:

```
awplus# configure terminal
awplus(config)# radius-server local
awplus(config-radsrv)# user VCSPCVLAN10 password VCSPCPass
group VLAN10Users
awplus(config-radsrv)# user VCSPCVLAN11 password VCSPCPass
group VLAN11Users
```

Authenticating login sessions

Authentication can be performed in multiple contexts, such as the authentication of users logging in at a console, as well as tri-authentication of devices connecting to switch ports, see [Tri-Authentication Configuration in Chapter 56, Authentication Configuration](#).

Add users to the RADIUS user list for authenticating login sessions

Adding entries to be used to authenticate login sessions on switches (by console, telnet or SSH) is also a two-step process:

Step 1: Create a group for administrative users

Create a group for administrative users and associate the appropriate service-type with this group with the following commands:

```
awplus# configure terminal
awplus(config)# radius-server local
awplus(config-radsrv)# group logins
awplus(config-radsrv)# attribute Service-Type 6
```

For a full list of attributes and values for each attribute, please refer to [Defined RADIUS attributes list](#) below.

Step 2: Add the users to the group

Add the users, and refer to the group in the command that creates the user as shown below:

```
awplus# conf t
awplus(config)# radius-server local
awplus(config-radsrv)# user netadmin password 45elephant98
group logins
```

Removing users from the RADIUS users list

To remove the user Tom from the user database of the Local RADIUS server, use the commands:

```
awplus# configure terminal
awplus(config)# radius-server local
awplus(config-radsrv)# no user Tom
```

Creating certificates for single users and all users

Create a certificate for a single user

A certificate for user Tom can be created from the local CA by using the commands:

```
awplus# configure terminal
awplus(config)# crypto pki enroll local user Tom
```

Create a certificate for all users

Certificates can be created for all currently defined users by using the commands:

```
awplus# configure terminal
awplus(config)# crypto pki enroll local local-radius-all-users
```

Exporting certificates

User certificates can be exported in PKCS12 format.

To export a certificate for user Tom and upload it to the TFTP server at 192.168.1.1, use the commands:

```
awplus# configure terminal
awplus(config)# crypto pki export local pkcs12 Tom tftp://
192.168.1.1/tomcert.pkcs
```

Defined RADIUS attributes list

This is a full list of valid attributes and pre-defined values that may be used in conjunction with the [attribute command on page 63.2](#), to show or configure defined RADIUS attributes.

[Table 62-1](#) lists all Standard attributes and values, [Table 62-2](#) lists the Vendor-Specific attribute (attribute ID 26) names and values.

More detailed information can be found in the following RFCs, defining the attributes and values for RADIUS server:

- RFC2865 : Remote Authentication Dial In User Service (RADIUS)
- RFC2866 : RADIUS Accounting
- RFC2867 : RADIUS Accounting Modifications for Tunnel Protocol Support
- RFC2868 : RADIUS Attributes for Tunnel Protocol Support
- RFC2869 : RADIUS Extensions
- RFC3579 : RADIUS (Remote Authentication Dial In User Service) Support For Extensible Authentication Protocol (EAP)
- RFC3580 : IEEE 802.1X Remote Authentication Dial In User Service (RADIUS) Usage Guidelines

Table 62-1: Standard RADIUS Attributes

Attribute ID and Name	Value Type/Pre-defined Values
1 User-Name	string
2 User-Password	string
3 CHAP-Password	octets (Hexadecimal string followed by 0x)
4 NAS-IP-Address	ipaddr (IPv4 address)
5 NAS-Port	Integer
6 Service-Type	Integer. Valid values are: <ul style="list-style-type: none"> ■ Administrative-User (6) ■ Authenticate-Only (8) ■ Authorize-Only (17) ■ Callback-Administrative (11) ■ Callback-Framed-User (4) ■ Callback-Login-User (3) ■ Callback-NAS-Prompt (9) ■ Call-Check (10) ■ Framed-User (2) ■ Login-User (1) ■ NAS-Prompt-User (7) ■ Outbound-User (5)
7 Framed-Protocol	Integer. Valid values are: <ul style="list-style-type: none"> ■ ARAP (3) ■ Gandalf-SLML (4) ■ PPP (1) ■ SLIP (2) ■ X.75-Synchronous (6) ■ Xylogics-IPX-SLIP (5)
8 Framed-IP-Address	ipaddr (IPv4 address)

Table 62-1: Standard RADIUS Attributes (cont.)

Attribute ID and Name	Value Type/Pre-defined Values
9 Framed-IP-Netmask	ipaddr (IPv4 address)
10 Framed-Routing	integer. Valid values are: <ul style="list-style-type: none"> ■ Broadcast (1) ■ Broadcast-Listen (3) ■ Listen (2) ■ None (0)
11 Filter-Id	string
12 Framed-MTU	Integer
13 Framed-Compression	Integer. Valid values are: <ul style="list-style-type: none"> ■ IPX-Header-Compression (2) ■ None (0) ■ Stac-LZS (3) ■ Van-Jacobson-TCP-IP (1)
14 Login-IP-Host	IP Address
15 Login-Service	Integer. Valid values are: <ul style="list-style-type: none"> ■ LAT (4) ■ PortMaster (3) ■ Rlogin (1) ■ TCP-Clear (2) ■ TCP-Clear-Quiet (8) ■ Telnet (0) ■ X25-PAD (5) ■ X25-T3POS (6)
16 Login-TCP-Port	Integer. Valid values are: <ul style="list-style-type: none"> ■ Rlogin (513) ■ Rsh (514) ■ Telnet (23)
18 Reply-Message	string
19 Callback-Number	string
20 Callback-Id	string
22 Framed-Route	string
23 Framed-IPX-Network	IP address
24 State	octets (Hexadecimal string followed by 0x)
25 Class	octets (Hexadecimal string followed by 0x)
26 Vendor-Specific	Use the Vendor-specific Attribute Name. For valid values, see " Vendor-Specific RADIUS Attributes " on page 62.13.
27 Session-Timeout	Integer
28 Idle-Timeout	Integer

Table 62-1: Standard RADIUS Attributes (cont.)

Attribute ID and Name	Value Type/Pre-defined Values
29 Termination-Action	Integer. Valid values are: <ul style="list-style-type: none"> ■ Default (0) ■ RADIUS-Request (1)
30 Called-Station-Id	string
31 Calling-Station-Id	string
32 NAS-Identifier	string
33 Proxy-State	octets (Hexadecimal string followed by 0x)
34 Login-LAT-Service	string
35 Login-LAT-Node	string
36 Login-LAT-Group	octets (Hexadecimal string followed by 0x)
37 Framed-AppleTalk-Link	Integer
38 Framed-AppleTalk-Network	Integer
39 Framed-AppleTalk-Zone	string
40 Acct-Status-Type	Integer. Valid values are: <ul style="list-style-type: none"> ■ Accounting-Off (8) ■ Accounting-On (7) ■ Alive (3) ■ Failed (15) ■ Interim-Update (3) ■ Start (1) ■ Stop (2) ■ Tunnel-Link-Reject (14) ■ Tunnel-Link-Start (12) ■ Tunnel-Link-Stop (13) ■ Tunnel-Reject (11) ■ Tunnel-Start (9) ■ Tunnel-Stop (10)
41 Acct-Delay-Time	Integer
42 Acct-Input-Octets	Integer
43 Acct-Output-Octets	Integer
44 Acct-Session-Id	string
45 Acct-Authentic	Integer. Valid values are: <ul style="list-style-type: none"> ■ Diameter (4) ■ Local (2) ■ RADIUS (1) ■ Remote (3)
46 Acct-Session-Time	Integer
47 Acct-Input-Packets	Integer
48 Acct-Output-Packets	Integer

Table 62-1: Standard RADIUS Attributes (cont.)

Attribute ID and Name	Value Type/Pre-defined Values
49 Acct-Terminate-Cause	Integer. Valid values are: <ul style="list-style-type: none"> ■ Admin-Reboot (7) ■ Admin-Reset (6) ■ Callback (16) ■ Host-Request (18) ■ Idle-Timeout (4) ■ Lost-Carrier (2) ■ Lost-Service (3) ■ NAS-Error (9) ■ NAS-Reboot (11) ■ NAS-Request (10) ■ Port-Disabled (22) ■ Port-Error (8) ■ Port-Preempted (13) ■ Port-Reinit (21) ■ Port-Suspended (14) ■ Port-Unneeded (12) ■ Reauthentication-Failure (20) ■ Service-Unavailable (15) ■ Session-Timeout (5) ■ Supplicant-Restart (19) ■ User-Error (17) ■ User-Request (1)
50 Acct-Multi-Session-Id	string
51 Acct-Link-Count	Integer
52 Acct-Input-Gigawords	Integer
53 Acct-Output-Gigawords	Integer
55 Event-Timestamp	date (Not supported)
56 Egress-VLANID	Integer
57 Ingress-Filters	Integer. Valid values are: <ul style="list-style-type: none"> ■ Disabled (2) ■ Enabled (1)
58 Egress-VLAN-Name	string
59 User-Priority-Table	octets (Hexadecimal string followed by 0x)
60 CHAP-Challenge	octets (Hexadecimal string followed by 0x)
61 NAS-Port-Type	Integer. Valid values are: <ul style="list-style-type: none"> ■ ADSL-CAP (12) ■ ADSL-DMT (13) ■ Async (0) ■ Cable (17) ■ Ethernet (15) ■ FDDI (21) ■ G.3-Fax (10) ■ HDLC-Clear-Channel (7)

Table 62-1: Standard RADIUS Attributes (cont.)

Attribute ID and Name	Value Type/Pre-defined Values
61 NAS-Port-Type (cont.)	Integer. Valid values are: <ul style="list-style-type: none"> ■ IDSL (14) ■ ISDN (2) ■ ISDN-V110 (4) ■ ISDN-V120 (3) ■ PIAFS (6) ■ SDSL (11) ■ Sync (1) ■ Token-Ring (20) ■ Virtual (5) ■ Wireless-802.11 (19) ■ Wireless-Other (18) ■ X.25 (8) ■ X.75 (9) ■ xDSL (16)
62 Port-Limit	Integer
63 Login-LAT-Port	Integer
64 Tunnel-Type	Integer. Valid values are: <ul style="list-style-type: none"> ■ AH (6) ■ ATMP (4) ■ DVS (11) ■ ESP (9) ■ GRE (10) ■ IP (7) ■ IP-in-IP (12) ■ L2F (2) ■ L2TP (3) ■ MIN-IP (8) ■ PPTP (1) ■ VLAN (13) ■ VTP (5)
65 Tunnel-Medium-Type	Integer. Valid values are: <ul style="list-style-type: none"> ■ Appletalk (12) ■ Banyan-Vines (14) ■ BBN-1822 (5) ■ DecNet-IV (13) ■ E.163 (7) ■ E.164 (8) ■ E.164-NSAP (15) ■ F.69 (9) ■ HDLC (4) ■ IEEE-802 (6) ■ IP (1) ■ IPv4 (1) ■ IPv6 (2) ■ IPX (11) ■ NSAP (3) ■ X.121 (10)
66 Tunnel-Client-Endpoint	string

Table 62-1: Standard RADIUS Attributes (cont.)

Attribute ID and Name	Value Type/Pre-defined Values
67 Tunnel-Server-Endpoint	string
68 Acct-Tunnel-Connection	string
69 Tunnel-Password	string
70 ARAP-Password	octets (Hexadecimal string followed by 0x)
71 ARAP-Features	octets (Hexadecimal string followed by 0x)
72 ARAP-Zone-Access	Integer. Valid values are: <ul style="list-style-type: none"> ■ Default-Zone (1) ■ Zone-Filter-Exclusive (4) ■ Zone-Filter-Inclusive (2)
73 ARAP-Security	Integer
74 ARAP-Security-Data	string
75 Password-Retry	integer
76 Prompt	integer. Valid values are: <ul style="list-style-type: none"> ■ Echo (1) ■ No-Echo (0)
77 Connect-Info	string
78 Configuration-Token	string
79 EAP-Message	octets (Hexadecimal string followed by 0x)
80 Message-Authenticator	octets (Hexadecimal string followed by 0x)
81 Tunnel-Private-Group-Id	string
82 Tunnel-Assignment-Id	string
83 Tunnel-Preference	Integer
84 ARAP-Challenge-Response	octets (Hexadecimal string followed by 0x)
85 Acct-Interim-Interval	Integer
86 Acct-Tunnel-Packets-Lost	Integer
87 NAS-Port-Id	string
88 Framed-Pool	string
89 Chargeable-User-Identity	string
90 Tunnel-Client-Auth-Id	string
91 Tunnel-Server-Auth-Id	string
95 NAS-IPv6-Address	ipv6addr (IPv6 address)
96 Framed-Interface-Id	ifid (Not supported)
97 Framed-IPv6-Prefix	ipv6prefix (Not supported)

Table 62-1: Standard RADIUS Attributes (cont.)

Attribute ID and Name	Value Type/Pre-defined Values
98 Login-IPv6-Host	ipv6addr (IPv6 address)
99 Framed-IPv6-Route	string
100 Framed-IPv6-Pool	string
101 Error-Cause	Integer. Valid values are: <ul style="list-style-type: none"> ■ Administratively-Prohibited (501) ■ Invalid-EAP-Packet (202) ■ Invalid-Request (404) ■ Missing-Attribute (402) ■ NAS-Identification-Mismatch (403) ■ Proxy-Processing-Error (505) ■ Proxy-Request-Not-Routable (502) ■ Request-Initiated (507) ■ Residual-Context-Removed (201) ■ Resources-Unavailable (506) ■ Session-Context-Not-Found (503) ■ Session-Context-Not-Removable (504) ■ Unsupported-Attribute (401) ■ Unsupported-Extension (406) ■ Unsupported-Service (405)

Table 62-2: Vendor-Specific RADIUS Attributes

Vendor-Specific Attribute Name	Value Type/Pre-defined Value
Actual-Data-Rate-Downstream	integer
Actual-Data-Rate-Upstream	integer
Actual-Interleaving-Delay-Downstream	integer
Actual-Interleaving-Delay-Upstream	integer
ADSL-Agent-Circuit-Id	string
ADSL-Agent-Remote-Id	string
Attainable-Data-Rate-Downstream	integer
Attainable-Data-Rate-Upstream	integer
call-id	string
Cisco-Abort-Cause	string
Cisco-Account-Info	string
Cisco-Assign-IP-Pool	integer
Cisco-AVPair	string
Cisco-Call-Filter	integer
Cisco-Call-Type	string

Table 62-2: Vendor-Specific RADIUS Attributes (cont.)

Vendor-Specific Attribute Name	Value Type/Pre-defined Value
Cisco-Command-Code	string
Cisco-Control-Info	string
Cisco-Data-Filter	integer
Cisco-Data-Rate	integer
Cisco-Disconnect-Cause	integer. Valid values are: <ul style="list-style-type: none"> ■ CLID-Authentication-Failure - 4 ■ Control-C-Detected - 27 ■ EXEC-Program-Destroyed - 28 ■ Exit-Raw-TCP - 24 ■ Exit-Telnet-Session - 22 ■ Failed-PPP-CHAP-Auth - 43 ■ Failed-PPP-LCP-Negotiation - 41 ■ Failed-PPP-PAP-Auth-Fail - 42 ■ Failed-PPP-Remote-Auth - 44 ■ Idle-Timeout - 21 ■ Invalid-Protocol - 120 ■ Lost-Carrier - 1 ■ No-Carrier - 0 ■ No-Detected-Result-Codes - 2 ■ No-Remote-IP-Addr - 23 ■ Password-Fail - 25 ■ PPP-Closed-Event - 46 ■ PPP-Remote-Terminate - 45 ■ Raw-TCP-Disabled - 26 ■ Session-End-Callback - 02 ■ Session-Failed-Security - 01 ■ Session-Timeout - 00 ■ Timeout-PPP-LCP - 40 ■ Unknown - 2 ■ User-Ends-Session - 20
Cisco-Email-Server-Ack-Flag	string
Cisco-Email-Server-Address	string
Cisco-Fax-Account-Id-Origin	string
Cisco-Fax-Auth-Status	string
Cisco-Fax-Connect-Speed	string
Cisco-Fax-Coverpage-Flag	string
Cisco-Fax-Dsn-Address	string
Cisco-Fax-Dsn-Flag	string
Cisco-Fax-Mdn-Address	string
Cisco-Fax-Mdn-Flag	string
Cisco-Fax-Modem-Time	string
Cisco-Fax-Msg-Id	string

Table 62-2: Vendor-Specific RADIUS Attributes (cont.)

Vendor-Specific Attribute Name	Value Type/Pre-defined Value
Cisco-Fax-Pages	string
Cisco-Fax-Process-Abort-Flag	string
Cisco-Fax-Recipient-Count	string
Cisco-Gateway-Id	string
Cisco-Idle-Limit	integer
Cisco-IP-Direct	integer
Cisco-IP-Pool-Definition	string
Cisco-Link-Compression	integer
Cisco-Maximum-Channels	integer
Cisco-Maximum-Time	integer
Cisco-Multilink-ID	integer
Cisco-NAS-Port	string
Cisco-Num-In-Multilink	integer
Cisco-Port-Used	string
Cisco-PPP-Async-Map	integer
Cisco-PPP-VJ-Slot-Comp	integer
Cisco-Pre-Input-Octets	integer
Cisco-Pre-Input-Packets	integer
Cisco-Pre-Output-Octets	integer
Cisco-Pre-Output-Packets	integer
Cisco-PreSession-Time	integer
Cisco-PW-Lifetime	integer
Cisco-Route-IP	integer
Cisco-Service-Info	string
Cisco-Target-Util	integer
Cisco-Xmit-Rate	integer
gw-final-xlated-cdn	string
gw-final-xlated-cgn	string
gw-rxd-cdn	string
gw-rxd-cgn	string
h323-billing-model	string

Table 62-2: Vendor-Specific RADIUS Attributes (cont.)

Vendor-Specific Attribute Name	Value Type/Pre-defined Value
h323-call-origin	string
h323-call-type	string
h323-conf-id	string
h323-connect-time	string
h323-credit-amount	string
h323-credit-time	string
h323-currency	string
h323-disconnect-cause	string
h323-disconnect-time	string
h323-gw-id	string
h323-incoming-conf-id	string
h323-preferred-lang	string
h323-prompt-id	string
h323-redirect-ip-address	string
h323-redirect-number	string
h323-remote-address	string
h323-return-code	string
h323-setup-time	string
h323-time-and-day	string
h323-voice-quality	string
incoming-req-uri	string
IWF-Session	octets
Maximum-Data-Rate-Downstream	integer
Maximum-Data-Rate-Upstream	integer
Maximum-Interleaving-Delay-Downstream	integer
Maximum-Interleaving-Delay-Upstream	integer
method	string
Minimum-Data-Rate-Downstream	integer
Minimum-Data-Rate-Downstream-Low-Power	integer
Minimum-Data-Rate-Upstream	integer
Minimum-Data-Rate-Upstream-Low-Power	integer

Table 62-2: Vendor-Specific RADIUS Attributes (cont.)

Vendor-Specific Attribute Name	Value Type/Pre-defined Value
MS-Acct-Auth-Type	integer. Valid values are: <ul style="list-style-type: none"> ■ CHAP - 2 ■ EAP - 5 ■ MS-CHAP-1 - 3 ■ MS-CHAP-2 - 4 ■ PAP - 1
MS-Acct-EAP-Type	integer. Valid values are: <ul style="list-style-type: none"> ■ Generic-Token-Card - 6 ■ MD5 - 4 ■ OTP - 5 ■ TLS -13
MS-ARAP-PW-Change-Reason	integer. Valid values are: <ul style="list-style-type: none"> ■ Admin-Requires-Password-Change - 3 ■ Expired-Password - 2 ■ Just-Change-Password - 1 ■ Password-Too-Short - 4
MS-BAP-Usage	integer. Valid values are: <ul style="list-style-type: none"> ■ Allowed - 1 ■ Not-Allowed - 0 ■ Required - 2
MS-CHAP2-CPW	octets
MS-CHAP2-Response	octets
MS-CHAP2-Success	octets
MS-CHAP-Challenge	octets
MS-CHAP-CPW-1	octets
MS-CHAP-CPW-2	octets
MS-CHAP-Domain	string
MS-CHAP-Error	string
MS-CHAP-LM-Enc-PW	octets
MS-CHAP-MPPE-Keys	octets
MS-CHAP-NT-Enc-PW	octets
MS-CHAP-Response	octets
MS-Filter	octets
MS-Link-Drop-Time-Limit	integer
MS-Link-Utilization-Threshold	integer
MS-MPPE-Encryption-Policy	octets
MS-MPPE-Encryption-Type	octets
MS-MPPE-Encryption-Types	octets

Table 62-2: Vendor-Specific RADIUS Attributes (cont.)

Vendor-Specific Attribute Name	Value Type/Pre-defined Value
MS-MPPE-Recv-Key	octets
MS-MPPE-Send-Key	octets
MS-New-ARAP-Password	octets
MS-Old-ARAP-Password	octets
MS-Primary-DNS-Server	ipaddr
MS-Primary-NBNS-Server	ipaddr
MS-RAS-Vendor	integer
MS-RAS-Version	string
MS-Secondary-DNS-Server	ipaddr
MS-Secondary-NBNS-Server	ipaddr
next-hop-dn	string
next-hop-ip	string
outgoing-req-uri	string
prev-hop-ip	string
prev-hop-via	string
release-source	string
remote-media-address	string
session-protocol	string
sip-hdr	string
subscriber	string

Chapter 63: Local RADIUS Server Commands



Command List	63.2
attribute	63.2
authentication	63.5
clear radius local-server statistics	63.6
copy fdb-radius-users (to file)	63.7
copy local-radius-user-db (from file)	63.9
copy local-radius-user-db (to file)	63.10
crypto pki enroll local	63.10
crypto pki enroll local local-radius-all-users	63.11
crypto pki enroll local user	63.12
crypto pki export local pem	63.13
crypto pki export local pkcs12	63.14
crypto pki trustpoint local	63.15
debug crypto	63.16
egress-vlan-id	63.17
egress-vlan-name	63.18
group	63.20
nas	63.21
radius-server local	63.22
server auth-port	63.23
server enable	63.24
show crypto pki certificates	63.25
show crypto pki certificates local-radius-all-users	63.27
show crypto pki certificates user	63.28
show crypto pki trustpoints	63.29
show radius local-server group	63.30
show radius local-server nas	63.31
show radius local-server statistics	63.32
show radius local-server user	63.33
user (RADIUS server)	63.35
vlan (RADIUS server)	63.37

Command List

This chapter provides an alphabetical reference for commands used to configure the local RADIUS server on the device. For more information, see [Chapter 62, Local RADIUS Server Introduction and Configuration](#).

attribute

Use this command to define a RADIUS attribute for the local RADIUS server user group.

For a complete list of defined RADIUS attributes and values, see [“Defined RADIUS attributes list” on page 62.7](#).

When used with the **help** parameter the **attribute** command displays a list of standard and vendor specific valid RADIUS attributes that are supported by the local RADIUS server.

If an attribute name is specified with the **help** parameter, then the **attribute** command displays a list of predefined attribute names. Note that you can only use the defined RADIUS attribute names and not define your own.

When used with the **value** parameter the **attribute** command configures RADIUS attributes to the user group. If the specified attribute is already defined then it is replaced with the new value.

Use the **no** variant of this command to delete an attribute from the local RADIUS server user group.

Syntax

```
attribute [<attribute-name>|<attribute-id>] help
attribute {<attribute-name>|<attribute-id>} <value>
no attribute {<attribute-name>|<attribute-id>}
```

Parameter	Description
<attribute-name>	RADIUS attribute name for standard attributes (see Table 62-1 on page 62.7) or Vendor-Specific attributes (see Table 62-2 on page 62.13).
<attribute-id>	RADIUS attribute numeric identifier for standard attributes (Table 62-1 on page 62.7).
<value>	RADIUS attribute value.
help	Display a list of available attribute types.

Default By default, no attributes are configured.

Mode RADIUS Server Group Configuration

Usage For the Standard attributes, the attribute may be specified using either the attribute name, or its numeric identifier. For example, command:

```
awplus(config-radsrv-group)# attribute acct-terminate-cause help
```

will produce the same results as command:

```
awplus(config-radsrv-group)# attribute 49 help
```

In the same way, where the specific attribute has a pre-defined value, the parameter *<value>* may be substituted with the Value Name or with its numeric value, for example command:

```
awplus(config-radsrv-group)# attribute acct-terminate-cause
user-request
```

will produce the same results as command:

```
awplus(config-radsrv-group)# attribute 49 1
```

or command:

```
awplus(config-radsrv-group)# attribute acct-terminate-cause 1
```

Example To check a list of all available defined RADIUS attribute names, use the following commands:

```
awplus# configure terminal
awplus(config)# radius-server local
awplus(config-radsrv)# group Admin
awplus(config-radsrv-group)# attribute help
```

A list of Vendor-specific Attributes displays after the list of defined Standard Attributes.

To get help for valid RADIUS attribute values for the attribute *Service-Type*, use the following commands:

```
awplus# configure terminal
awplus(config)# radius-server local
awplus(config-radsrv)# group Admin
awplus(config-radsrv-group)# attribute Service-Type help
```

```
Service-Type : integer (Integer number)
Pre-defined values :
Administrative-User (6)
Authenticate-Only (8)
Authorize-Only (17)
Callback-Administrative (11)
Callback-Framed-User (4)
Callback-Login-User (3)
Callback-NAS-Prompt (9)
Call-Check (10)
Framed-User (2)
Login-User (1)
NAS-Prompt-User (7)
Outbound-User (5)
```

To define the attribute name 'Service-Type' with Administrative User (6) to the RADIUS User Group 'Admin', use the following commands:

```
awplus# configure terminal
awplus(config)# radius-server local
awplus(config-radsrv)# group Admin
awplus(config-radsrv-group)# attribute Service-Type 6
```

To delete the attribute 'Service-Type' from the RADIUS User Group 'Admin', use the following commands:

```
awplus# configure terminal
awplus(config)# radius-server local
awplus(config-radsrv)# group Admin
awplus(config-radsrv-group)# no attribute Service-Type
```

Related Commands [egress-vlan-id](#)
[egress-vlan-name](#)

authentication

Use this command to enable the specified authentication methods on the local RADIUS server.

Use the **no** variant of this command to disable specified authentication methods on the local RADIUS server.

Syntax `authentication {mac|eapmd5|eaptls|peap}`
`no authentication {mac|eapmd5|eaptls|peap}`

Parameter	Description
mac	Enable MAC authentication method
eapmd5	Enable EAP-MD5 authentication method
eaptls	Enable EAP-TLS authentication method
peap	Enable EAP-PEAP authentication method

Default All authentication methods are enabled by default.

Mode RADIUS Server Configuration

Example The following commands enable EAP-MD5 authentication methods on the local RADIUS server.

```
awplus# configure terminal
awplus(config)# radius-server local
awplus(config-radsrv)# authentication eapmd5
```

The following commands disable EAP-MD5 authentication methods on Local RADIUS server.

```
awplus# configure terminal
awplus(config)# radius-server local
awplus(config-radsrv)# no authentication eapmd5
```

Related Commands `server enable`
`show radius local-server statistics`

clear radius local-server statistics

Use this command to clear the statistics stored on the switch for the local RADIUS server.

Use this command without any parameters to clear all types of local RADIUS server statistics.

Syntax `clear radius local-server statistics [nas|server|user]`

Parameter	Description
<code>nas</code>	Clear the NAS (Network Access Server) statistics on the switch. For example, clearing statistics stored for NAS server invalid passwords.
<code>server</code>	Clear the Local RADIUS Server statistics on the switch. For example, clearing Local RADIUS Servers statistics for all failed login attempts.
<code>user</code>	Clear the Local RADIUS Server user statistics. For example, clearing statistics stored for the number of successful user logins.

Mode Privileged Exec

Usage Refer to the sample output for the [show radius local-server statistics](#) for further information about the type of statistics each parameter option for this command clears. Both the `nas` and `server` parameters clear unknown username and invalid passwords statistics, while the `user` parameter clears the number of successful and failed logins for each local RADIUS server user.

Example To clear the NAS (Network Access Server) statistics stored on the switch, use the command:

```
awplus# clear radius local-server statistics nas
```

To clear the local RADIUS server statistics stored on the switch, use the command:

```
awplus# clear radius local-server statistics server
```

To clear the local RADIUS server user statistics stored on the switch, use the command:

```
awplus# clear radius local-server statistics user
```

Related Commands [show radius local-server statistics](#)

copy fdb-radius-users (to file)

Use this command to create a set of local RADIUS server users from MAC addresses in the local FDB. A local RADIUS server user created using this command can be used for MAC authentication.

Syntax `copy fdb-radius-users {local-radius-user-db|flash|nvs|card|debug|tftp|scp|<url>} [interface <port>] [vlan <vid>] [group <name>]`

Parameter	Description
<code>local-radius-user-db</code>	Copy the local RADIUS server users created to the local RADIUS server.
<code>flash</code>	Copy the local RADIUS server users created to flash memory.
<code>nvs</code>	Copy the local RADIUS server users created to NVS memory.
<code>card</code>	Copy the local RADIUS server users created to SD card.
<code>debug</code>	Copy the local RADIUS server users created to debug.
<code>tftp</code>	Copy the local RADIUS server users created to the TFTP destination.
<code>scp</code>	Copy the local RADIUS server users created to the SCP destination.
<code><url></code>	Copy the local RADIUS server users created to the specified URL.
<code>interface <port></code>	Copy only MAC addresses learned on a specified switch port. Wildcards may be used when specifying an interface name. For example, when you specify <code>interface port1.*</code> then this command generates RADIUS server users for MAC addresses learned on stack 1.
<code>vlan <vid></code>	Copy only MAC addresses learned on a specified VLAN.
<code>group <name></code>	Assign a group name to the local RADIUS server users created.

Mode Privileged Exec

Usage The local RADIUS server users created are written to a specified destination file in local RADIUS user CSV (Comma Separated Values) format. The local RADIUS server users can then be imported to a local RADIUS server using the [copy local-radius-user-db \(from file\)](#) command.

The name and password of the local RADIUS server users created use a MAC address, which can be used for MAC authentication.

This command does not copy a MAC address learned by the CPU or the management port.

This command can filter FDB entries by the interface name and the VLAN ID. When the interface name and the VLAN ID are specified, this command generates local RADIUS server users from only the MAC address learned on the specified interface and on the specified VLAN.

Examples To register the local RADIUS server users from the local FDB directly to the local RADIUS server, use the command:

```
awplus# copy fdb-radius-users local-radius-user-db
```

To register the local RADIUS server users from the interface port1.0.1 to the local RADIUS server, use the command:

```
awplus# copy fdb-radius-users local-radius-user-db interface  
port1.0.1
```

To copy output generated as local RADIUS server user data from MAC addresses learned on vlan10 on interface port1.0.1 to the file radius-user.csv, use the command:

```
awplus# copy fdb-radius-users radius-user.csv interface  
port1.0.1 vlan10
```

Related Commands [copy local-radius-user-db \(to file\)](#)
[copy local-radius-user-db \(from file\)](#)

copy local-radius-user-db (from file)

Use this command to copy the Local RADIUS server user data from a file. The file, including the RADIUS user data in the file, must be in the CSV (Comma Separated Values) format.

You can select **add** or **replace** as the copy method. The **add** parameter option copies the contents of specified file to the local RADIUS server user database. If the same user exists then the old user is removed before adding a new user. The **replace** parameter option deletes all contents of the local RADIUS server user database before copying the contents of specified file.

Syntax `copy <source-url> local-radius-user-db [add|replace]`

Parameter	Description
<code><source-url></code>	URL of the source file.
<code>add</code>	Add file contents to local RADIUS server user database.
<code>replace</code>	Replace current local RADIUS server user database with file contents.

Default When no copy method is specified with this command the **replace** option is applied.

Mode Privileged Exec

Examples To replace the current local RADIUS server user data to the contents of `http://datahost/user.csv`, use the following command:

```
awplus# copy http://datahost/user.csv local-radius-user-db
```

To add the contents of `http://datahost/user.csv` to the current local RADIUS server user database, use the following command:

```
awplus# copy http://datahost/user.csv local-radius-user-db add
```

Related commands [copy fdb-radius-users \(to file\)](#)
[copy local-radius-user-db \(to file\)](#)

copy local-radius-user-db (to file)

Use this command to copy the local RADIUS server user data to a file. The output file produced is CSV (Comma Separated Values) format.

Syntax `copy local-radius-user-db {flash|nvs|card|tftp|scp}<destination-url>`

Parameter	Description
flash	Copy to flash memory.
nvs	Copy to NVS memory.
card	Copy to SD card.
tftp	Copy to TFTP destination.
scp	Copy to SCP destination.
<destination-url>	URL of the Destination file.

Mode Privileged Exec

Example Copy the current local RADIUS server user data to http://datahost/user.csv.

```
awplus# copy local-radius-user-db http://datahost/user.csv
```

Related Commands [copy fdb-radius-users \(to file\)](#)
[copy local-radius-user-db \(from file\)](#)

crypto pki enroll local

Use this command to obtain a system certificate from the Local CA (Certificate Authority).

Use the **no** variant of this command to delete system certificates created by a Local CA (Certificate Authority).

Syntax `crypto pki enroll local`
`no crypto pki enroll local`

Default The system certificate is not available until this command is issued.

Mode Global Configuration

Example The following command obtains the system certificate from the Local CA (Certificate Authority).

```
awplus# configure terminal
awplus(config)# crypto pki enroll local
```

The following command deletes the system certificate created by the Local CA (Certificate Authority).

```
awplus# configure terminal
awplus(config)# no crypto pki enroll local
```

Related Commands [crypto pki trustpoint local group](#)

crypto pki enroll local local-radius-all-users

Use this command to create certificates for all users registered in the local RADIUS server. These certificates are created by the Local Certificate Authority (CA) on the switch.

Syntax `crypto pki enroll local local-radius-all-users`

Default By default, there are no certificates for users in the local RADIUS server.

Mode Global Configuration

Example The following command obtains the local RADIUS server certificates for the user from the Local CA (Certificate Authority).

```
awplus# configure terminal
awplus(config)# crypto pki enroll local local-radius-all-users
```

Related Commands [crypto pki trustpoint local show crypto pki certificates](#)

crypto pki enroll local user

Use this command to obtain a local user certificate from the Local CA (Certificate Authority).

Use the **no** variant of this command to delete user certificates created by the Local CA (Certificate Authority).

Syntax `crypto pki enroll local user <user-name>`
`no crypto pki enroll local user <user-name>`

Parameter	Description
<code><user-name></code>	User name.

Default By default, there is no user certificate.

Mode Global Configuration

Example The following command obtains Tom's certificate from the Local CA (Certificate Authority).

```
awplus# configure terminal
awplus(config)# crypto pki enroll local user Tom
```

The following command deletes Tom's certificates created by the Local CA (Certificate Authority):

```
awplus# configure terminal
awplus(config)# no crypto pki enroll local user Tom
```

Related Commands [crypto pki trustpoint local](#)
[show crypto pki certificates](#)

crypto pki export local pem

Use this command to export the certificate associated with the Local CA to a PEM format file.

Syntax `crypto pki export local pem url <url>`

Parameter	Description
<url>	URL string.

Mode Global Configuration

Example The following command exports the Local CA certificate to a PEM format file.

```
awplus# configure terminal
awplus(config)# crypto pki export local pem url tftp://
192.168.1.1/cacert.pem
```

Related Commands [crypto pki enroll local](#)

crypto pki export local pkcs12

Use this command to export a specified certificate to a PKCS12 format file.

This command cannot be used for exporting certificates for the local system.

Syntax `crypto pki export local pkcs12 <user-name> <destination-url>`

Parameter	Description
<code><user-name></code>	User name.
<code><destination-url></code>	Destination URL string.

Mode Global Configuration

Example The following commands exports a certificate for a user named **client** to a PKCS12 format file.

```
awplus# configure terminal
awplus(config)# crypto pki export local pkcs12 client tftp://
192.168.1.1/cacert.pem
```

To export Tom's certificate to PKSC12 format file, use the commands:

```
awplus# configure terminal
awplus(config)# crypto pki export local pksc12 Tom tftp://
192.168.1.1/tom.pfx
```

Related Commands [crypto pki enroll local](#)

crypto pki trustpoint local

Use this command to declare the Local CA (Certificate Authority) as the trustpoint that the system uses. The ca-trustpoint configuration mode is available after this command is issued.

Use the **no** variant of this command to delete all information and certificates associated with Local CA as the trustpoint.

Syntax `crypto pki trustpoint local`
`no crypto pki trustpoint local`

Default Local CA is not a trustpoint.

Mode Global Configuration

Examples Use the following commands to declare the Local CA as the trustpoint.

```
awplus# configure terminal
awplus(config)# crypto pki trustpoint local
```

Use the following commands to delete all information and certificates associated with the Local CA.

```
awplus# configure terminal
awplus(config)# no crypto pki trustpoint local
```

To create a client certificate for all users registered to the local RADIUS server, use the following commands:

```
awplus(config)# crypto pki trustpoint local
awplus(ca-trust-point)# exit
awplus(config)# crypto pki enroll local alternative
```

Related Commands `crypto pki enroll local`
`show crypto pki trustpoints`

debug crypto

Use this command to enable Public Key Infrastructure (PKI) debugging. When PKI debugging is enabled, the PKI module starts generating diagnostic messages to the system log.

Use the **no** variant of this command to disable Public Key Infrastructure (PKI) debugging. When PKI debugging is disabled, the PKI module stops generating diagnostic messages to the system log.

Syntax `debug crypto pki`
`no debug crypto pki`

Default PKI debugging is disabled by default

Mode Privileged Exec

Example To enable the PKI debugging facility, use the command:

```
awplus# debug crypto pki
```

To disable the PKI debugging facility, use the command:

```
awplus# no debug crypto pki
```

egress-vlan-id

Use this command to configure the standard RADIUS attribute 'Egress-VLANID (56)' for the local RADIUS Server user group.

Use the **no** variant of this command to remove the Egress-VLANID attribute from the local RADIUS server user group.

Syntax `egress-vlan-id <vid> [tagged|untagged]`
`no egress-vlan-id`

Parameter	Description
<code><vid></code>	The VLAN identifier to be used for the Egress VLANID attribute, in the range 1 to 4094.
<code>tagged</code>	Set frames on the VLAN as tagged. This sets the tag indication field to indicate that all frames on this VLAN are tagged.
<code>untagged</code>	Set all frames on the VLAN as untagged. This sets the tag indication field to indicate that all frames on this VLAN are untagged.

Default By default, no Egress-VLANID attributes are configured.

Mode RADIUS Server Group Configuration

Usage When a Voice VLAN is configured for dynamic VLAN allocation ([switchport voice vlan command on page 17.19](#)), the RADIUS server must be configured to send the VLAN information when an IP phone is successfully authenticated. Use either the [egress-vlan-id command](#) or the [egress-vlan-name command on page 63.18](#), and specify the **tagged** parameter.

Examples To set the 'Egress-VLANID' attribute for the NormalUsers local RADIUS server user group to VLAN identifier 200, with tagged frames, use the commands:

```
awplus# configure terminal
awplus(config)# radius-server local
awplus(config-radsrv)# group NormalUsers
awplus(config-radsrv-group)# egress-vlan-id 200 tagged
```

To remove the 'Egress-VLANID' attribute for the NormalUsers local RADIUS server user group, use the commands:

```
awplus# configure terminal
awplus(config)# radius-server local
awplus(config-radsrv)# group NormalUsers
awplus(config-radsrv-group)# no egress-vlan-id
```

Related Commands [attribute](#)
[egress-vlan-name](#)
[switchport voice vlan](#)

egress-vlan-name

Use this command to configure the standard RADIUS attribute 'Egress-VLAN-Name (58)' for the local RADIUS server user group.

Use the **no** variant of this command to remove the Egress-VLAN-Name attribute from the local RADIUS server user group.

Syntax `egress-vlan-name <vlan-name> [tagged|untagged]`
`no egress-vlan-name`

Parameter	Description
<code><vlan-name></code>	The VLAN name to be configured as the Egress-VLAN-Name attribute.
<code>tagged</code>	Set frames on the VLAN as tagged. This sets the tag indication field to indicate that all frames on this VLAN are tagged.
<code>untagged</code>	Set all frames on the VLAN as untagged. This sets the tag indication field to indicate that all frames on this VLAN are untagged.

Default By default, no Egress-VLAN-Name attributes are configured.

Mode RADIUS Server Group Configuration

Usage When a Voice VLAN is configured for dynamic VLAN allocation ([switchport voice vlan command on page 17.19](#)), the RADIUS server must be configured to send the VLAN information when an IP phone is successfully authenticated. Use either the [egress-vlan-id command on page 63.17](#) or the [egress-vlan-name](#) command, and specify the **tagged** parameter.

Examples To configure the 'Egress-VLAN-Name' attribute for the RADIUS server user group NormalUsers with the VLAN name 'vlan2' and all frames on this VLAN tagged, use the commands:

```
awplus# configure terminal
awplus(config)# radius-server local
awplus(config-radsrv)# group NormalUsers
awplus(config-radsrv-group)# egress-vlan-name vlan2 tagged
```

To delete the 'Egress-VLAN-Name' attribute for the NormalUsers group, use the commands:

```
awplus# configure terminal
awplus(config)# radius-server local
awplus(config-radsrv)# group NormalUsers
awplus(config-radsrv-group)# no egress-vlan-name
```

Related Commands [attribute](#)
 [egress-vlan-id](#)
 [switchport voice vlan](#)

group

Use this command to create a local RADIUS server user group, and enter local RADIUS Server User Group Configuration mode.

Use the **no** variant of this command to delete the local RADIUS server user group.

Syntax `group <user-group-name>`
`no group <user-group-name>`

Parameter	Description
<code><user-group-name></code>	User group name string

Mode RADIUS Server

Example The following command creates the user group NormalUsers.

```
awplus# configure terminal
awplus(config)# radius-server local
awplus(config-radsrv)# group NormalUsers
```

The following command deletes user group NormalUsers.

```
awplus# configure terminal
awplus(config)# radius-server local
awplus(config-radsrv)# no group NormalUsers
```

Related Commands `user (RADIUS server)`
`show radius local-server user`
`vlan (RADIUS server)`

nas

This command adds a client device (the Network Access Server or the NAS) to the list of devices that are able to send authentication requests to the local RADIUS server. The NAS is identified by its IP address and a shared secret (also referred to as a shared key) must be defined that the NAS will use to establish its identity.

Use the **no** variant of this command to remove a NAS client from the list of devices that are allowed to send authentication requests to the local RADIUS server.

Syntax `nas <ip-address> key <nas-keystring>`
`no nas <ip-address>`

Parameter	Description
<code><ip-address></code>	RADIUS NAS IP address
<code><nas-keystring></code>	NAS shared keystring

Mode RADIUS server

Example The following commands add the NAS with an IP address of 192.168.1.2 to the list of clients that may send authentication requests to the local RADIUS server. Note the shared key that this NAS will use to establish its identify is NAS_PASSWORD.

```
awplus# configure terminal
awplus(config)# radius-server local
awplus(config-radsrv)# nas 192.168.1.2 key NAS_PASSWORD
```

The following commands remove the NAS with an IP address of 192.168.1.2 from the list of clients that are allowed to send authentication requests to the local RADIUS server:

```
awplus# configure terminal
awplus(config)# radius-server local
awplus(config-radsrv)# no nas 192.168.1.2
```

Related Commands [show radius local-server nas](#)

radius-server local

Use this command to navigate to the Local RADIUS server configuration mode (`config-radsrv`) from the Global Configuration mode (`config`).

Syntax `radius-server local`

Mode Global Configuration

Example Local RADIUS Server commands are available from `config-radsrv` configuration mode. To change mode from User Exec mode to the Local RADIUS Server mode (`config-radsrv`), use the commands:

```
awplus# configure terminal
awplus(config)# radius-server local
awplus(config-radsrv)#
```

Output

```
awplus(config)#radius-server local
Creating Local CA repository....OK
Enrolling Local System to local trustpoint..OK
awplus(config-radsrv)#
```

Related Commands

- `server enable`
- `show radius local-server group`
- `show radius local-server nas`
- `show radius local-server statistics`
- `show radius local-server user`

server auth-port

Use this command to change the UDP port number for local RADIUS server authentication.

Use the **no** variant of this command to reset the RADIUS server authentication port back to the default.

Syntax `server auth-port <1-65535>`

`no server auth-port`

Parameter	Description
<1-65535>	UDP port number

Default The default local RADIUS server UDP authentication port number is 1812.

Mode RADIUS Server

Example The following commands set the RADIUS server authentication port to 10000.

```
awplus# configure terminal
awplus(config)# radius-server local
awplus(config-radsrv)# server port 10000
```

The following commands reset the RADIUS server authentication port back to the default UDP port of 1812.

```
awplus# configure terminal
awplus(config)# radius-server local
awplus(config-radsrv)# no server port
```

Related Commands `server enable`
`show radius local-server statistics`

server enable

This command enables the local RADIUS server. The local RADIUS server feature is started immediately when this command is issued.

The **no** variant of this command disables local RADIUS server. When this command is issued, the local RADIUS server stops operating.

Syntax `server enable`
`no server enable`

Default The local RADIUS server is disabled by default and must be enabled for use with this command.

Mode RADIUS Server

Examples To enable the local RADIUS server, use the following commands:

```
awplus# configure terminal
awplus(config)# radius-server local
awplus(config-radsrv)# server enable
```

To disable the local RADIUS server, use the command:

```
awplus# configure terminal
awplus(config)# radius-server local
awplus(config-radsrv)# no server enable
```

Related Commands `server auth-port`
`show radius local-server statistics`

show crypto pki certificates

Use this command to display certificate information for Local CA and Local System certificates.

For information on output options, see [“Controlling “show” Command Output” on page 1.35.](#)

Syntax `show crypto pki certificates [local-ca|local]`

Parameter	Description
local-ca	Local CA certificate
local	Local system certificate

Mode Privileged Exec

Example The following command displays Local CA (Certificate Authority) certificate information.

```
awplus# show crypto pki certificates local-ca
```

The following command displays Local System certificate information.

```
awplus# show crypto pki certificates local
```

The following command displays information for all Local CA and Local System certificates.

```
awplus# show crypto pki certificates
```

Output

Figure 63-1: Example output from the **show crypto pki certificates** command showing Local System and Local CA certificates

```
awplus#show crypto pki certificates
Certificate: Local System
  Data:
    Version: 3 (0x2)
    Serial Number: 4 (0x4)
    Signature Algorithm: sha1WithRSAEncryption
    Issuer: O=Allied-Telesis, CN=AlliedwarePlusCA
    Validity
      Not Before: Oct  8 07:50:55 2009 GMT
      Not After  : Oct  6 07:50:55 2019 GMT
    Subject: O=Allied-Telesis, CN=Tom
Certificate: Local CA
  Data:
    Version: 3 (0x2)
    Serial Number: 0 (0x0)
    Signature Algorithm: sha1WithRSAEncryption
    Issuer: O=Allied-Telesis, CN=AlliedwarePlusCA
    Validity
      Not Before: Oct  8 07:55:55 2009 GMT
      Not After  : Oct  6 07:55:55 2019 GMT
    Subject: O=Allied-Telesis, CN=Tom
```

Table 63-1: Parameters in the output from the `show crypto pki certificates` command

Parameter	Description
Certificate	Certificate name
Version	Protocol version
Serial Number	Serial number of the certificate
Signature Algorithm	Algorithm used for the certificate signature
Issuer	Subject of issuer creating the certificate
Validity	Validity period
Subject	Subject of the certificate

Related Commands `crypto pki enroll local`

show crypto pki certificates local-radius-all-users

Use this command to display certificate information for local RADIUS server users.

For information on output options, see “Controlling “show” Command Output” on page 1.35.

Syntax show crypto pki certificates local-radius-all-users

Mode Privileged Exec

Example The following command displays information of all local RADIUS server user certificates.

```
awplus# show crypto pki certificates local-radius-all-users
```

Output

Figure 63-2: Example output from the **show crypto pki certificates local-radius-all-users** command

```
awplus#show crypto pki certificates local-radius-all-users
Certificate:
  Data:
    Version: 3 (0x2)
    Serial Number: 2 (0x2)
    Signature Algorithm: sha1WithRSAEncryption
    Issuer: O=Allied-Telesis, CN=AlliedwarePlusCA
    Validity
      Not Before: Oct  8 07:50:55 2009 GMT
      Not After  : Oct  6 07:50:55 2019 GMT
    Subject: O=Allied-Telesis, CN=Tom
```

Table 63-2: Parameters in the output from the **show crypto pki certificates local-radius-all-users** command

Parameter	Description
Certificate	Certificate name
Version	Protocol version
Serial Number	Serial number of the certificate
Signature Algorithm	Algorithm used for the certificate signature
Issuer	Subject of issuer creating the certificate
Validity	Validity period
Subject	Subject of the certificate

Related Commands crypto pki enroll local local-radius-all-users

show crypto pki certificates user

Use this command to display certificate information for a specified local RADIUS server user.

For information on output options, see “Controlling “show” Command Output” on page 1.35.

Syntax `show crypto pki certificates user [<user-name>]`

Parameter	Description
<user-name>	user name

Mode Privileged Exec

Example The following command displays Tom's certificate information.

```
awplus# show crypto pki certificates user Tom
```

Output

Figure 63-3: Example output from the `show crypto pki certificates user` command to show certificate information for user Tom

```
awplus#show crypto pki certificates user Tom
Certificate:
  Data:
    Version: 3 (0x2)
    Serial Number: 2 (0x2)
    Signature Algorithm: sha1WithRSAEncryption
    Issuer: O=Allied-Telesis, CN=AlliedwarePlusCA
    Validity
      Not Before: Oct  8 07:50:55 2009 GMT
      Not After : Oct  6 07:50:55 2019 GMT
    Subject: O=Allied-Telesis, CN=Tom
```

Table 63-3: Parameters in the output from the `show crypto pki certificates user` command

Parameter	Description
Certificate	Certificate name
Version	Protocol version
Serial Number	Serial number of the certificate
Signature Algorithm	Algorithm used for the certificate signature
Issuer	Subject of issuer creating the certificate
Validity	Validity period
Subject	Subject of the certificate

Related Commands `crypto pki enroll local user`

show crypto pki trustpoints

Use this command to display trustpoint information.

For information on output options, see [“Controlling “show” Command Output” on page 1.35.](#)

Syntax `show crypto pki trustpoints`

Mode Privileged Exec

Example The following command displays trustpoint information.

```
awplus# show crypto pki trustpoint
```

Output

Figure 63-4: Example output from the `show crypto pki trustpoints` command

```
Trustpoint local:
Subject Name:
CN = AlliedwarePlusCA
o = Allied-Telesis
Serial Number:0C
```

Table 63-4: Parameters in the output from the `show crypto pki trustpoints` command

Parameter	Description
Subject Name	CA certificate subject
Serial Number	Current serial number of CA

Related Commands `crypto pki enroll local`

show radius local-server group

Use this command to display information about the local RADIUS server user group.

For information on output options, see “Controlling “show” Command Output” on page 1.35.

Syntax `show radius local-server group [<user-group-name>]`

Parameter	Description
<user-group-name>	User group name string

Mode Privileged Exec

Example The following command displays Local RADIUS server user group information.

```
awplus# show radius local-server group
```

Output

Figure 63-5: Example output from the **show radius local-server group** command

Group-Name	Vlan

NetworkOperators	ManagementNet
NormalUsers	CommonNet

Table 63-5: Parameters in the output from the **show radius local-server group** command

Parameter	Description
Group-Name	Group name
Vlan	VLAN name assigned to the group

Related Commands `group`

show radius local-server nas

Use this command to display information about NAS (Network Access Servers) registered to the local RADIUS server.

For information on output options, see [“Controlling “show” Command Output” on page 1.35.](#)

Syntax `show radius local-server nas [<ip-address>]`

Parameter	Description
<ip-address>	Specify NAS IP address for show output

Mode Privileged Exec

Example The following command displays NAS information.

```
awplus# show radius local-server nas
```

Output

Figure 63-6: Example output from the **show radius local-server nas** command

NAS-Address	Shared-Key
-----	-----
127.0.0.1	awplus-local-radius-server

Table 63-6: Parameters in the output from the **show radius local-server nas** command

Parameter	Description
NAS-Address	IP address of NAS
Shared-Key	Shared key used for RADIUS connection

Related Commands `nas`

show radius local-server statistics

Use this command to display statistics about the local RADIUS server.

For information on output options, see [“Controlling “show” Command Output” on page 1.35.](#)

Syntax show radius local-server statistics

Mode Privileged Exec

Usage Both unknown usernames and invalid passwords will display as failed logins in the show output.

Example The following command displays Local RADIUS server statistics.

```
awplus# show radius local-server statistics
```

Output

Figure 63-7: Example output from the **show radius local-server statistics** command

```
x900#show radius local-server statistics
Server status : Run (administrative status is enable)
Enabled methods: MAC EAP-MD5 EAP-TLS EAP-PEAP

Successes          :1  Unknown NAS          :0
Failed Logins      :0  Invalid packet from NAS :0
Internal Error     :0  Unknown Error          :0

NAS : 127.0.0.1
Successes          :0  Shared key mismatch     :0
Failed Logins      :0  Unknown RADIUS message  :0
Unknown EAP message :0  Unknown EAP auth type   :0
Corrupted packet   :0

NAS : 192.168.1.61
Successes          :0  Shared key mismatch     :0
Failed Logins      :0  Unknown RADIUS message  :0
Unknown EAP message :0  Unknown EAP auth type   :0
Corrupted packet   :0

NAS : 192.168.1.63
Successes          :1  Shared key mismatch     :0
Failed Logins      :0  Unknown RADIUS message  :0
Unknown EAP message :0  Unknown EAP auth type   :0
Corrupted packet   :0

NAS : 192.168.1.65
Successes          :0  Shared key mismatch     :0
Failed Logins      :0  Unknown RADIUS message  :0
Unknown EAP message :0  Unknown EAP auth type   :0
Corrupted packet   :0

Username          Successes  Failures
a                  1          0
admin              0          0
```

Related Commands [clear radius local-server statistics](#)
[radius-server local](#)
[server enable](#)
[server auth-port](#)

show radius local-server user

Use this command to display information about the local RADIUS server user.

For information on output options, see [“Controlling “show” Command Output” on page 1.35.](#)

Syntax `show radius local-server user [<user-name>]`
`show radius local-server user <user-name> format csv`

Parameter	Description
<code><user-name></code>	RADIUS user name. If no user name is specified, information for all users is displayed.
<code>format</code>	File format
<code>csv</code>	Comma separated value format

Mode Privileged Exec

Usage You can send output from any show command, including the CSV format output from this command, to a file. See [“Controlling “show” Command Output” on page 1.35.](#)

Example The following command displays Local RADIUS server user information for user Tom.

```
awplus# show radius local-server user Tom
```

Figure 63-8: Example output from the show radius local-server user command

User-Name	Password	Group	Vlan
Tom	abcd	NetworkOperators	ManagementNet

The following command displays all Local RADIUS server information for all users.

```
awplus# show radius local-server user
```

The following command displays Local RADIUS server user information for TOM in CSV format.

```
awplus# show radius local-server user Tom format csv
```

Figure 63-9: Example output from the show radius local-server user ... csv command

<pre>true, "NetworkOperators", "Tom", "abcd", 0, 2099/01/ 01, 1, "", "", "ManagementNet", false, 3600, false, 0, "", false, "</pre>

Table 63-7: Parameters in the output from the **show radius local-server user** command

Parameter	Description
User-Name	User name
Password	User password
Group	Group name assigned to the user
Vlan	VLAN name assigned to the user

Related Commands [group](#)
[user \(RADIUS server\)](#)

user (RADIUS server)

Use this command to register a user to the local RADIUS server.

Use the **no** variant of this command to delete a user from the local RADIUS server.

Syntax `user <radius-user-name> [encrypted] password <user-password> [group <user-group>]`
`no user <radius-user-name>`

Parameter	Description
<code><radius-user-name></code>	RADIUS user name. This can also be a MAC address in the IEEE standard format of <code>HH-HH-HH-HH-HH-HH</code> if you are configuring MAC authentication to use local RADIUS server.
<code>encrypted</code>	Specifies that the password is being entered in its encrypted form, so that it is not further encrypted. When creating a new user, enter the password in plaintext, and do not use the encrypted parameter. Use the encrypted parameter only when referring to a user that has previously been created. For instance, when adding an existing user from another RADIUS server, use the encrypted parameter, and enter the encrypted version of the password that appears in the output of show commands for the user.
<code><user-password></code>	User password. This can also be a MAC address in the IEEE standard format of <code>HH-HH-HH-HH-HH-HH</code> if you are configuring MAC authentication to use local RADIUS server.
<code>group</code>	Specify the group for the user
<code><user-group></code>	User group name

Mode RADIUS Server

Usage RADIUS user names cannot contain question mark (?), space (), or quote (" ") characters. RADIUS user names containing the below characters cannot use certificate authentication:

`/ \ ` $ & () * ; < > ` |`

Certificates cannot be created and exported for RADIUS user names that contain the above characters. We advise you to avoid using these characters in RADIUS user names if you need to use certificate authentication, because you will not be able to create and export certificates.

You also can use the IEEE standard format hexadecimal notation (HH-HH-HH-HH-HH-HH) to specify a supplicant MAC address to configure the user name and user password parameters to use local RADIUS server for MAC Authentication. See the [Sample MAC Authentication Configuration](#) in [Chapter 58, AAA Introduction and Configuration](#). See also the command `user 00-db-59-ab-70-37 password 00-db-59-ab-70-37` as shown in the command examples.

Examples The following commands add user Tom to the local RADIUS server and sets his password to QwerSD.

```
awplus# configure terminal
awplus(config)# radius-server local
awplus(config-radsrv)# user Tom password QwerSD
```

The following commands add user Tom to the local RADIUS server user group NormalUsers and sets his password QwerSD.

```
awplus# configure terminal
awplus(config)# radius-server local
awplus(config-radsrv)# user Tom password QwerSD group
NormalUsers
```

The following commands remove user Tom from the local RADIUS server:

```
awplus# configure terminal
awplus(config)# radius-server local
awplus(config-radsrv)# no user Tom
```

The following commands add the supplicant MAC address 00-d0-59-ab-70-37 to the local RADIUS server:

```
awplus# configure terminal
awplus(config)# radius-server local
awplus(config-radsrv)# user 00-db-59-ab-70-37 password 00-db-
59-ab-70-37
```

The following commands remove the supplicant MAC address 00-d0-59-ab-70-37 from the local RADIUS server:

```
awplus# configure terminal
awplus(config)# radius-server local
awplus(config-radsrv)# no user 00-db-59-ab-70-37
```

Related Commands [group](#)
[show radius local-server user](#)

vlan (RADIUS server)

Use this command to set the VLAN ID or name for the local RADIUS server user group. The VLAN information is used for authentication with the dynamic VLAN feature.

Use the **no** variant of this command to clear the VLAN ID or VLAN name for the local RADIUS server user group.

Syntax `vlan {<vid>|<vlan-name>}`
`no vlan`

Parameter	Description
<code><vid></code>	VLAN ID
<code><vlan-name></code>	VLAN name

Default VLAN information is not set by default.

Mode RADIUS Server Group

Example The following commands set VLAN ID 200 to the group named NormalUsers:

```
awplus# configure terminal
awplus(config)# radius-server local
awplus(config-radsrv)# group NormalUsers
awplus(config-radsrv-group)# vlan 200
```

The following commands remove VLAN ID 200 from the group named NormalUsers:

```
awplus# configure terminal
awplus(config)# radius-server local
awplus(config-radsrv)# group NormalUsers
awplus(config-radsrv-group)# no vlan
```

Related Commands `group`
`show radius local-server user`

Chapter 64: Secure Shell (SSH) Introduction



Introduction.....	64.2
Secure Shell on the AlliedWare Plus OS.....	64.2
Configuring the SSH Server.....	64.4
Creating a Host Key.....	64.4
Enabling the Server.....	64.4
Modifying the Server.....	64.5
Validating the Server Configuration.....	64.6
Adding SSH Users.....	64.6
Authenticating SSH Users.....	64.7
Adding a Login Banner.....	64.7
Monitoring the Server and Managing Sessions.....	64.8
Debugging the Server.....	64.8
Configuring the SSH Client.....	64.9
Modifying the Client.....	64.9
Adding SSH Servers.....	64.10
Authenticating with a Server.....	64.10
Connecting to a Server and Running Commands.....	64.11
Copying files to and from the Server.....	64.11
Debugging the Client.....	64.11

Introduction

This chapter describes how the Secure Shell protocol is implemented in the AlliedWare Plus™ Operating System. It covers:

- Support for Secure Shell.
- Configuring your device as a Secure Shell server and client.
- Using Secure Shell to manage your device.

The AlliedWare Plus™ OS supports SSH version 2 and SSH version 1.5, making it backwards compatible with SSH version 1.

Secure management is important in modern networks, as the ability to easily and effectively manage switches and routers, and the requirement for security, are two almost universal requirements. Protocols such as Telnet and rlogin allow you to manage devices remotely, but can have serious security problems, such as relying on reusable plaintext passwords that are vulnerable to wiretapping or password guessing. The Secure Shell (SSH) protocol is superior to these protocols by providing encrypted and strongly authenticated remote login sessions.

SSH provides sessions between a host running a SSH server and a machine with a SSH client. The AlliedWare Plus™ OS includes both a SSH server and a SSH client to enable you to securely—with the benefit of cryptographic authentication and encryption—manage your devices over an insecure network:

- SSH replaces Telnet for remote terminal sessions; SSH is strongly authenticated and encrypted.
- Remote command execution allows you to send commands to a device securely and conveniently, without requiring a terminal session on the device.
- SSH allows you to connect to another host from your switch or router.

The AlliedWare Plus™ OS supports Secure Copy (SCP) and SSH File Transfer Protocol (SFTP). Both these protocols allow you to securely copy files between your device and remote machines. SFTP provides additional features from SCP, such as allowing you to manipulate the remote files, and halt or resume file transfers without closing the session.

Secure Shell on the AlliedWare Plus OS

The AlliedWare Plus™ OS implementation of SSH is compatible with the following RFCs and Internet Drafts:

- The Secure Shell (SSH) Protocol Architecture (RFC 4251)
- The Secure Shell (SSH) Authentication Protocol (RFC 4252)
- The Secure Shell (SSH) Transport Layer Protocol (RFC 4253)
- The Secure Shell (SSH) Connection Protocol (RFC 4254)
- The SSH (Secure Shell) Remote Login Protocol (draft-ylonen-ssh-protocol-00.txt)
- SSH File Transfer Protocol (draft-ietf-secsh-filexfer-13.txt)

Secure Shell supports the following features for both SSH version 2 and SSH version 1.5:

- Inbound SSH connections (server mode) and outbound SSH connections (client mode).
- File loading to and from remote machines using Secure Copy, using either the SSH client or SSH server mode.
- RSA public keys with lengths of 768–32768 bits, and DSA keys with lengths of 1024 bits. Keys are stored in a format compatible with other SSH implementations, and mechanisms are provided to copy keys to and from your device.
- Secure encryption, such as Triple DES and Blowfish.
- Remote non-interactive shell that allows arbitrary commands to be sent securely to your device, possibly automatically.
- Compression of Secure Shell traffic.
- Tunnelling of TCP/IP traffic.

Secure Shell supports the following features for SSH version 2 only:

- File loading from remote machines using SSH File Transfer Protocol (SFTP).
- A login banner on the SSH server, that displays when SSHv2 clients connect to the server.

Configuring the SSH Server

This section provides instructions on:

- [Creating a Host Key](#)
- [Enabling the Server](#)
- [Modifying the Server](#)
- [Validating the Server Configuration](#)
- [Adding SSH Users](#)
- [Authenticating SSH Users](#)
- [Adding a Login Banner](#)
- [Monitoring the Server and Managing Sessions](#)
- [Debugging the Server](#)

Creating a Host Key

The SSH server uses either an RSA or DSA host key to authenticate itself with SSH clients. This key must be configured before the SSH server can operate. If no host key exists, you cannot start the SSH server.

Once created, the host key is stored securely on the device. To generate a host key for the SSH server, use the command:

```
awplus(config)# crypto key generate hostkey {dsa|rsa|rsa1} [<768-32768>]
```

This command has two parameters for creating RSA keys. The **rsa** parameter creates a host key for SSH version 2 sessions only. To create a host key for SSH version 1 sessions, use the **rsa1** parameter.

To destroy a host key, use the command:

```
awplus(config)# crypto key destroy hostkey {dsa|rsa|rsa1}
```

To display a host key stored on your device, use the command:

```
awplus(config)# show crypto key hostkey [dsa|rsa|rsa1]
```

Enabling the Server

You must enable the SSH server before connections from SSH, SCP, and SFTP clients are accepted. When the SSH server is disabled it rejects connections from SSH clients. The SSH server is disabled by default on your device.

To enable the SSH server, use the command:

```
awplus(config)# service ssh [ip|ipv6]
```

To disable the SSH server, use the command:

```
awplus(config)# no service ssh [ip|ipv6]
```

When enabled, the SSH server allows SCP and SFTP sessions by default. To disable these services, use the commands:

```
awplus(config)# no ssh server scp
```

```
awplus(config)# no ssh server sftp
```

This allows you to reject SCP or SFTP file transfer requests, while still allowing Secure Shell connections. To re-enable SCP and SFTP services, use the command:

```
awplus(config)# ssh server scp
```

```
awplus(config)# ssh server sftp
```

Modifying the Server

To modify the SSH version that the server supports, or the TCP port that the server listens to for incoming sessions, use the command:

```
awplus(config)# ssh server {[v1v2|v2only]<1-65535>}
```

The server listens on port 22 for incoming sessions, and supports both SSH version 2 and SSH version 1, by default.

To modify session and login timeouts on the SSH server, and the number of unauthenticated connections the server allows, use the command:

```
awplus(config)# ssh server {[session-timeout <0-3600>} [login-timeout <1-600>]
[max-startups <1-128>]}
```

The SSH server waits 60 seconds for a client to authenticate itself, by default. You can alter this waiting time by using the **login-timeout** parameter. If the client is still not authenticated after the set timeout, then the SSH server disconnects the session.

The SSH server only allows only 10 unauthenticated SSH sessions at any point in time, by default. You can modify the number of unauthenticated sessions it allows, by using the **max-startups** parameter.

Once a client has authenticated, the SSH session does not time out, by default. Use the **session-timeout** parameter to set a **maximum time period the server waits before deciding that a session is inactive and terminating it**

For example, to set the session timeout to 600 seconds, the login timeout to 30 seconds, and the maximum number of concurrent unauthenticated sessions to 5, use the command::

```
awplus(config)# ssh server session-timeout 600 login-timeout
30 max-startups 5
```

To remove the configured session timeout, login timeout, or maximum startups, use the command:

```
awplus(config)# no ssh server session-timeout login-timeout
max-startups
```

Validating the Server Configuration

To validate the SSH server configuration, use the command:

```
awplus(config)# show running-config ssh
```

Adding SSH Users

The SSH server requires you to register SSH users. Users that are not registered cannot access the SSH server. Ensure first that you have defined the user in the Authorized User Database of your device. To add a new user, use the command:

```
awplus(config)# username USERNAME (privilege 1-15) password  
PASSWORD
```

To register a user with the SSH server, use the command:

```
awplus(config)# ssh server allow-users <username-pattern> [<hostname-pattern>]
```

Registered entries can contain just the username, or the username with some host details, such as an IP address range. Additionally you can specify a range of users or hostname details by using an asterisk to match any string of characters. For example, to allow any user from the IP range 192.168.1.1 to 192.168.1.255, use the command:

```
awplus(config)# ssh server allow-users * 192.168.1.*
```

To display the list of allowed users, use the command:

```
awplus# show ssh server allow-users
```

To delete an entry from the list of allowed users, use the command:

```
awplus(config)# no ssh server allow-users <username-pattern> [<hostname-  
pattern>]
```

The SSH server also contains a list of denied users. The server checks all incoming sessions against this list and denies any matching session, regardless of whether the session matches an entry in the allowed users list. To add an entry to the list of denied users, use the command:

```
awplus(config)# ssh server deny-users <username-pattern> [<hostname-pattern>]
```

This allows you to deny specific users from a range of allowed users. For example, to deny a user with the IP address 192.168.1.12, use the command:

```
awplus(config)# ssh server deny-users * 192.168.1.12
```

To display the database of denied users, use the command:

```
awplus# show ssh server deny-users
```

To delete a client from the database of denied users, use the command:

```
awplus(config)# no ssh server deny-users <username-pattern> [<hostname-pattern>]
```

Authenticating SSH Users

SSH users can use either their password or public key authentication to authenticate themselves with the SSH server. To use public key authentication, copy the user's public key file from their client device to the SSH server. To associate the key with a user, use the command:

```
awplus(config)# crypto key pubkey-chain userkey <username> [<filename>]
```

For example, to associate the file `keypub` with the user "langley", use the command:

```
awplus(config)# crypto key pubkey-chain userkey langley  
key.pub
```

To add a key as text into the terminal for user "geoff", first enter the command:

```
awplus(config)# crypto key pubkey-chain userkey geoff
```

then paste or type the key in as text.

You can add multiple keys for the same user. To display the list of public keys associated with a user, use the command:

```
awplus(config)# show crypto key pubkey-chain userkey <username>[<1-65535>]
```

The `<1-65535>` parameter allows you to display an individual key.

To delete a key associated with a user from your device, use the command:

```
awplus(config)# no crypto key pubkey-chain userkey <username> <1-65535>
```

Adding a Login Banner

You can add a login banner to the SSH server for sessions with SSH version 2 clients. The server displays the banner to clients before the login prompt. To set the login banner's message, use the command:

```
awplus(config)# banner login
```

then enter your message and use Ctrl+D to finish.

To view the configured login banner, use the command:

```
awplus# show banner login
```

To remove the configured message for the login banner, use the command:

```
awplus(config)# no banner login
```

Monitoring the Server and Managing Sessions

To display the current status of the SSH server, use the command:

```
awplus# show ssh server
```

To display the current status of SSH sessions on your device, use the command:

```
awplus# show ssh
```

Note that this displays both SSH server and SSH client sessions that your Allied Telesis device is running. Use this command to view the unique identification number assigned to each incoming or outgoing SSH session. You need the ID number when terminating a specific session from your device.

To terminate a session, or all sessions, use the command:

```
awplus# clear ssh {<1-65535>|all}
```

Debugging the Server

Information which may be useful for troubleshooting the SSH server is available using the SSH debugging function. You can enable server debugging while the SSH server is functioning. Use the command:

```
awplus# debug ssh server [brief|full]
```

To disable SSH server debugging, use the command:

```
awplus# no debug ssh server
```

Configuring the SSH Client

This section provides instructions on:

- [Modifying the Client](#)
- [Adding SSH Servers](#)
- [Authenticating with a Server](#)
- [Connecting to a Server and Running Commands](#)
- [Copying files to and from the Server](#)
- [Debugging the Client](#)

Modifying the Client

You can configure a selection of variables when using the SSH client. Note that the following configuration commands apply only to client sessions initiated after the command. The configured settings are not saved; after you have logged out from the SSH client, the client returns to using the default settings. Use the command:

```
awplus(config)# ssh client {port <1-65535>|version {1|2}|session-timeout  
<0-3600>|connect-timeout <1-600>}
```

The SSH client uses TCP port 22, by default. You can change the TCP port for the remote SSH server by using the **port** parameter.

The client supports both SSH version 1 and version 2 sessions, by default. To change the SSH client to only use a specific SSH version for sessions, for example SSH version 1, use the **version** parameter.

The client **terminates sessions that are not established after 30 seconds, by default. You can change this time period by using the session-timeout parameter.**

Once the client has authenticated with a server, the client does not time out the SSH session, by default. Use the **session-timeout** parameter to set a maximum time period the client waits before deciding that a session is inactive and terminating the session.

To modify the SSH client so that it uses port 2000 for sessions, and supports only SSH version 1 connections, use the command:

```
awplus(config)# ssh client port 2000 version 1
```

To modify the SSH client so that unestablished sessions time out after 60 seconds, and inactive sessions time out after 100 seconds, use the command:

```
awplus(config)# ssh client session-timeout 100  
connect-timeout 100
```

To remove the configured port, SSH version, session timeout, and connection timeout settings, use the command:

```
awplus(config)# no ssh client port version session-timeout  
connect-timeout
```

Adding SSH Servers

SSH servers identify themselves using a host key (see “Creating a Host Key” on page 64.4). Before the SSH client establishes a session with a SSH server, it confirms that the host key sent by the server matches its database entry for the server. If the database does not contain a host key for the server, then the SSH client requires you to confirm that the host key sent from the server is correct.

To add an SSH server to the client's database, use the command:

```
awplus(config)# crypto key pubkey-chain knownhosts <hostname>
                {dsa|rsa|rsa1}
```

To display the SSH servers in the client's database, use the command:

```
awplus# show crypto key pubkey-chain knownhosts [<1-65535>]
```

To remove an entry in the database, use the command:

```
awplus(config)# no crypto key pubkey-chain knownhosts
                <1-65535>
```

Authenticating with a Server

You can authenticate your session with a server by either using a password, or using RSA or DSA public key authentication. To use public key authentication, you must generate a pair of keys, one private and one public, and copy the public key onto the SSH server.

To generate an RSA or DSA set of private and public keys for an SSH user, use the command:

```
awplus(config)# crypto key generate userkey <username> {dsa|rsa|rsa1}
                [<768-32768>]
```

You can generate one key of each encryption type per user on your client. When authenticating with an SSH server that supports SSH version 1 only, you must use a key generated by the `rsa1` parameter.

To copy the public key onto the SSH server, you must display the key onscreen. To display the public key associated with a user, use the command:

```
awplus# show crypto key userkey <username> [dsa|rsa|rsa1]
```

To display the public keys set for other users, you must specify their username. Only users with the highest privilege setting can use this command to view the keys of other users.

To delete a public and private pair of keys associated with a user, use the command:

```
awplus(config)# crypto key destroy userkey <username> {dsa|rsa|rsa1}
```

Connecting to a Server and Running Commands

To connect to a remote SSH server and execute a command, use the command:

```
awplus# ssh [ip|ipv6][{user <username>|port <1-65535>|version {1|2}}]
<hostname> [<line>]
```

By default, the SSH client attempts to use SSH version 2 with the SSH server. If this fails, the client uses SSH version 1.

For example, to connect to the SSH server at 192.168.1.2 as user "john", and execute the command "show sys", use the command:

```
awplus# ssh user john 192.168.1.2 "show sys"
```

Copying files to and from the Server

You can use either the SCP or SFTP client to transfer files from a remote SSH server. Use the command:

```
awplus# copy <source-url> <destination-url>
```

For example, to use SFTP to load a file from the SSH server 192.168.1.2, onto the flash memory of your device, use the command:

```
awplus# copy sftp://192.168.1.2/key.pub flash
```

To upload files to the SSH server, you must use SCP. For example, to upload the file bobskey.pub as the user "bob", use the command:

```
awplus# copy flash:/bobskey.pub scp://bob@192.168.1.2
```

For more information see [Chapter 6, Creating and Managing Files](#).

Debugging the Client

Information which may be useful for troubleshooting the SSH client is available using the SSH debugging function. You can enable client debugging while the SSH client is functioning. Use the command:

```
awplus# debug ssh client [brief/full]
```

To disable SSH client debugging, use the command:

```
awplus# no debug ssh client
```

Chapter 65: Secure Shell (SSH) Configuration



SSH Server Configuration Example.....	65.2
---------------------------------------	------

SSH Server Configuration Example

This chapter provides a Secure Shell server configuration example. For more information about the SSH server, see [Chapter 64, Secure Shell \(SSH\) Introduction](#). For detailed information about the commands used to configure the SSH server, see [Chapter 66, Secure Shell \(SSH\) Commands](#).

The following example configures a SSH server where:

- the SSH server uses RSA encryption
- the SSH server is compatible with both SSH version 1 and version 2 clients
- three SSH users are configured: Manager, John and Asuka. "Manager" can connect from only a defined range of hosts, while "john" and "asuka" can SSH from all hosts
- the SSH users use RSA private and public key authentication

This example shows how to create RSA encryption keys, configure the Secure Shell server, and register users to make Secure Shell connections to your device.

Step 1: Login as a highest Privileged User.

To create the keys and add users, you must login as a privileged user.

Step 2: Create encryption keys.

Two RSA private keys are required before enabling the Secure Shell server for each type of SSH version. Use the commands:

```
awplus# configure terminal
awplus(config)# crypto key generate hostkey rsa
awplus(config)# crypto key generate hostkey rsa1
awplus(config)# exit
```

To verify the key creation, use the command:

```
awplus# show crypto key hostkey
```

Step 3: Enable the Secure Shell server.

Enable Secure Shell on the device using the commands:

```
awplus# configure terminal
awplus(config)# service ssh
```

Modify the SSH server settings as desired. For example, to set the login-timeout to 60, and the session-timeout to 3600, use the commands:

```
awplus(config)# ssh server session-timeout 3600 login-timeout 60
```

To verify the server configuration, use the command:

```
awplus# show ssh
```

Step 4: Create SSH users.

In order to connect and execute commands, you must register users in the SSH user database, and in the User Authentication Database of the device.

To create the users `john` and `asuka` in the User Authentication Database, use the commands:

```
awplus# configure terminal
awplus(config)# username john privilege 15 password secret
awplus(config)# username asuka privilege 15 password very-secret
```

To register `john` and `asuka` as SSH clients, use the commands:

```
awplus(config)# ssh server allow-users john
awplus(config)# ssh server allow-users asuka
```

To register "manager" as an SSH client so that can only connect from the IP address 192.168.1.1, use the command:

```
awplus(config)# ssh server allow-users manager 192.168.1.1
```

Step 5: Set up Authentication.

SSH users cannot connect unless the server can authenticate them. There are two ways to authenticate an SSH session: password authentication, and RSA or DSA private/public key authentication. When using password authentication, the user must supply their User Authentication Database password.

To use private/public key authentication, copy the public keys for each user onto the device. To copy the files onto flash from the key directory of an attached TFTP server, use the command:

```
awplus# copy tftp://key/john.pub flash:/john.pub
awplus# copy tftp://key/asuka.pub flash:/asuka.pub
```

To associate the key file with each user, use the command:

```
awplus# configure terminal
awplus(config)# cryto key pubkey-chain userkey john john.pub
awplus(config)# cryto key pubkey-chain userkey asuka asuka.pub
awplus(config)# cryto key pubkey-chain userkey manager
manager.pub
```

Chapter 66: Secure Shell (SSH) Commands



Command List	66.2
banner login (SSH)	66.2
clear ssh	66.3
crypto key destroy hostkey	66.4
crypto key destroy userkey	66.5
crypto key generate hostkey	66.6
crypto key generate userkey	66.7
crypto key pubkey-chain knownhosts	66.8
crypto key pubkey-chain userkey	66.10
debug ssh client	66.11
debug ssh server	66.12
service ssh	66.13
show banner login	66.14
show crypto key hostkey	66.15
show crypto key pubkey-chain knownhosts	66.16
show crypto key pubkey-chain userkey	66.17
show crypto key userkey	66.18
show running-config ssh	66.19
show ssh	66.20
show ssh client	66.21
show ssh server	66.22
show ssh server allow-users	66.23
show ssh server deny-users	66.24
ssh	66.25
ssh client	66.27
ssh server	66.29
ssh server allow-users	66.31
ssh server authentication	66.33
ssh server deny-users	66.34
ssh server scp	66.35
ssh server sftp	66.36
undebug ssh client	66.36
undebug ssh server	66.36

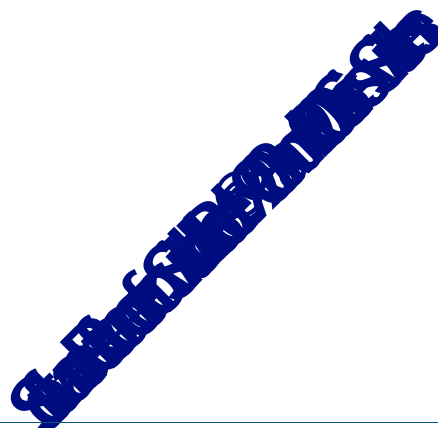

Command List

This chapter provides an alphabetical reference for commands used to configure Secure Shell (SSH). For more information, see [Chapter 64, Secure Shell \(SSH\) Introduction](#), and [Chapter 65, Secure Shell \(SSH\) Configuration](#).

banner login (SSH)

This command configures a login banner on the SSH server. This displays a message on the remote terminal of the SSH client before the login prompt. SSH client version 1 does not support this banner.

To add a banner, first enter the command **banner login**, and hit [Enter]. Write your message. You can use any character and spaces. Use Ctrl+D at the end of your message to save the text and re-enter the normal command line mode.

The banner message is preserved if the device restarts.

The **no** variant of this command deletes the login banner from the device.

Syntax banner login
no banner login

Default No banner is defined by default.

Mode Global Configuration

Examples To set a login banner message, use the commands:

```
awplus# configure terminal
awplus(config)# banner login
```

Type CNTL/D to finish.

```
... banner message comes here ...
```

```
^D
```

```
awplus(config)#
```

and enter the message. Use Ctrl+D to finish.

To remove the login banner message, use the commands:

```
awplus# configure terminal
awplus(config)# no banner login
```

Related Commands [show banner login](#)

clear ssh

This command deletes Secure Shell sessions currently active on the device. This includes both incoming and outgoing sessions. The deleted sessions are closed. You can only delete an SSH session if you are a system manager or the user who initiated the session. If **all** is specified then all active SSH sessions are deleted.

Syntax `clear ssh {<1-65535>|all}`

Parameters	Description
<1-65535>	Specify a session ID in the range 1 to 65535 to delete a specific session.
all	Delete all SSH sessions.

Mode Privileged Exec

Examples To stop the current SSH session 123, use the command:

```
awplus# clear ssh 123
```

To stop all SSH sessions active on the device, use the command:

```
awplus# clear ssh all
```

Related Commands [service ssh](#)
[ssh](#)

crypto key destroy hostkey

This command deletes the existing public and private keys of the SSH server. Note that for an SSH server to operate it needs at least one set of hostkeys configured before an SSH server is started.

Syntax `crypto key destroy hostkey {dsa|rsa|rsa1}`

Parameters	Description
<code>dsa</code>	Deletes the existing DSA public and private keys.
<code>rsa</code>	Deletes the existing RSA public and private keys configured for SSH version 2 connections.
<code>rsa1</code>	Deletes the existing RSA public and private keys configured for SSH version 1 connections.

Mode Global Configuration

Example To destroy the RSA host key used for SSH version 2 connections, use the commands:

```
awplus# configure terminal
awplus(config)# crypto key destroy hostkey rsa
```

Related Commands [crypto key generate hostkey](#)
[service ssh](#)

crypto key destroy userkey

This command destroys the existing public and private keys of an SSH user configured on the device.

Syntax `crypto key destroy userkey <username> {dsa|rsa|rsa1}`

Parameters	Description
<code><username></code>	Name of the user whose userkey you are destroying. The username must begin with a letter. Valid characters are all numbers, letters, and the underscore, hyphen and full stop symbols.
<code>dsa</code>	Deletes the existing DSA userkey.
<code>rsa</code>	Deletes the existing RSA userkey configured for SSH version 2 connections.
<code>rsa1</code>	Deletes the existing RSA userkey for SSH version 1 connections.

Mode Global Configuration

Example To destroy the RSA user key for the SSH user `remoteuser`, use the commands:

```
awplus# configure terminal
awplus(config)# crypto key destroy userkey remoteuser rsa
```

Related Commands [crypto key generate hostkey](#)
[show ssh](#)
[show crypto key hostkey](#)

crypto key generate hostkey

This command generates public and private keys for the SSH server using either an RSA or DSA cryptography algorithm. You must define a host key before enabling the SSH server. Start SSH server using the **service ssh** command. If a host key exists with the same cryptography algorithm, this command replaces the old host key with the new key.

This command is not saved in the device configuration. However, the device saves the keys generated by this command in the non-volatile memory.

Syntax `crypto key generate hostkey {dsa|rsa|rsa1} [<768-32768>]`

Parameters	Description
<code>dsa</code>	Creates a DSA hostkey. Both SSH version 1 and 2 connections can use the DSA hostkey.
<code>rsa</code>	Creates an RSA hostkey for SSH version 2 connections.
<code>rsa1</code>	Creates an RSA hostkey for SSH version 1 connections.
<code><768-32768></code>	The length in bits of the generated key. The default is 1024 bits.

Default 1024 bits is the default key length. The DSA algorithm supports 1024 bits.

Mode Global Configuration

Examples To generate an RSA host key for SSH version 2 connections that is 2048 bits in length, use the commands:

```
awplus# configure terminal
awplus(config)# crypto key generate hostkey rsa 2048
```

To generate a DSA host key, use the commands:

```
awplus# configure terminal
awplus(config)# crypto key generate dsa
```

Related Commands [crypto key destroy hostkey](#)
[service ssh](#)
[show crypto key hostkey](#)

crypto key generate userkey

This command generates public and private keys for an SSH user using either an RSA or DSA cryptography algorithm. To use public key authentication, copy the public key of the user onto the remote SSH server.

This command is not saved in the device configuration. However, the device saves the keys generated by this command in the non-volatile memory.

Syntax `crypto key generate userkey <username> {dsa|rsa|rsa1} [<768-32768>]`

Parameters	Description
<username>	Name of the user that the user key is generated for. The username must begin with a letter. Valid characters are all numbers, letters, and the underscore, hyphen and full stop symbols.
dsa	Creates a DSA userkey. Both SSH version 1 and 2 connections can use a key created with this command.
rsa	Creates an RSA userkey for SSH version 2 connections.
rsa1	Creates an RSA userkey for SSH version 1 connections.
<768-32768>	The length in bits of the generated key. The DSA algorithm supports only 1024 bits. Default: 1024.

Mode Global Configuration

Examples To generate a 2048-bits RSA user key for SSH version 2 connections for the user `bob`, use the commands:

```
awplus# configure terminal
awplus(config)# crypto key generate userkey bob rsa 2048
```

To generate a DSA user key for the user `lapo`, use the commands:

```
awplus# configure terminal
awplus(config)# crypto key generate userkey lapo dsa
```

Related Commands [crypto key destroy userkey](#)
[show crypto key userkey](#)

crypto key pubkey-chain knownhosts

This command adds a public key of the specified SSH server to the known host database on your switch. The SSH client on your switch uses this public key to verify the remote SSH server.

The key is retrieved from the server. Before adding a key to this database, check that the key sent to you is correct.

If the server's key changes, or if your SSH client does not have the public key of the remote SSH server, then your SSH client will inform you that the public key of the server is unknown or altered.

The **no** variant of this command deletes the public key of the specified SSH server from the known host database on your device.

Syntax `crypto key pubkey-chain knownhosts [ip|ipv6] <hostname> [rsa|dsa|rsa1]`

`no crypto key pubkey-chain knownhosts <1-65535>`

Parameter	Description
<code>ip</code>	Keyword used prior to specifying an IPv4 address
<code>ipv6</code>	Keyword used prior to specifying an IPv6 address
<code><hostname></code>	IPv4/IPv6 address or hostname of a remote server in the format <code>a.b.c.d</code> for an IPv4 address, or in the format <code>x:x::x:x</code> for an IPv6 address
<code>rsa</code>	Specify the RSA public key of the server to be added to the known host database.
<code>dsa</code>	Specify the DSA public key of the server to be added to the known host database.
<code>rsa1</code>	Specify the SSHv1 public key of the server to be added to the known host database.
<code><1-65535></code>	Specify a key identifier when removing a key using the no parameter.

Default If no cryptography algorithm is specified, then **rsa** is used as the default cryptography algorithm.

Mode Privilege Exec

Usage This command adds a public key of the specified SSH server to the known host database on the switch. The key is retrieved from the server. The remote SSH server is verified by using this public key. The user is requested to check the key is correct before adding it to the database.

If the remote server's host key is changed, or if the device does not have the public key of the remote server, then SSH clients will inform the user that the public key of the server is altered or unknown.

Example To add the RSA host key of the remote SSH host IPv4 address `192.0.2.11` to the known host database, use the command:

```
awplus# crypto key pubkey-chain knownhosts 192.0.2.11
```

To delete the second entry in the known host database, use the command:

```
awplus# no crypto key pubkey-chain knownhosts 2
```

Validation show crypto key pubkey-chain knownhosts
Commands

crypto key pubkey-chain userkey

This command adds a public key for an SSH user onto the SSH server. This allows the server to support public key authentication for the user. When configured, the user can access the SSH server without providing a password from the remote host.

You should import the public key file from the client node. The device can read the data from a file on the flash or user terminal.

To add a key as text into the terminal, first enter the command **crypto key pubkey-chain userkey <username>**, and hit [Enter]. Enter the key as text. Use Ctrl+D at the end to save the text and re-enter the normal command line mode.

The **no** variant of this command removes a public key for the specified SSH user that has been added to the public key chain. When a user's public key is removed, the user can no longer login using public key authentication.

Syntax `crypto key pubkey-chain userkey <username> [<filename>]`
`no crypto key pubkey-chain userkey <username> <1-65535>`

Parameters	Description
<username>	Name of the user that the SSH server associates the key with. The username must begin with a letter. Valid characters are all numbers, letters, and the underscore, hyphen and full stop symbols. Default: no default
<filename>	Filename of a key saved in flash. Valid characters are any printable character. You can add a key as a hexadecimal string directly into the terminal if you do not specify a filename.
<1-65535>	The key ID number of the user's key. Specify the key ID to delete a key.

Mode Global Configuration

Examples To add a public key for the user `graydon` from the file `key.pub`, use the commands:

```
awplus# configure terminal
awplus(config)# crypto key pubkey-chain userkey graydon key.pub
```

To add a public key for the user `tamara` from the terminal, use the commands:

```
awplus# configure terminal
awplus(config)# crypto key pubkey-chain userkey tamara
```

and enter the key. Use Ctrl+D to finish.

To remove the first key entry from the public key chain of the user `john`, use the commands:

```
awplus# configure terminal
awplus(config)# no crypto key pubkey-chain userkey john 1
```

Related Commands [show crypto key pubkey-chain userkey](#)

debug ssh client

This command enables the SSH client debugging facility. When enabled, any SSH, SCP and SFTP client sessions send diagnostic messages to the login terminal.

The **no** variant of this command disables the SSH client debugging facility. This stops the SSH client from generating diagnostic debugging message.

Syntax `debug ssh client [brief|full]`
`no debug ssh client`

Parameter	Description
brief	Enables brief debug mode.
full	Enables full debug mode.

Default SSH client debugging is disabled by default.

Mode Privileged Exec and Global Configuration

Examples To start SSH client debugging, use the command:

```
awplus# debug ssh client
```

To start SSH client debugging with extended output, use the command:

```
awplus# debug ssh client full
```

To disable SSH client debugging, use the command:

```
awplus# no debug ssh client
```

Related Commands `debug ssh server`
`show ssh client`
`undebug ssh client`

debug ssh server

This command enables the SSH server debugging facility. When enabled, the SSH server sends diagnostic messages to the system log. To display the debugging messages on the terminal, use the **terminal monitor** command.

The **no** variant of this command disables the SSH server debugging facility. This stops the SSH server from generating diagnostic debugging messages.

Syntax `debug ssh server [brief|full]`
`no debug ssh server`

Parameter	Description
brief	Enables brief debug mode.
full	Enables full debug mode.

Default SSH server debugging is disabled by default.

Mode Privileged Exec and Global Configuration

Examples To start SSH server debugging, use the command:

```
awplus# debug ssh server
```

To start SSH server debugging with extended output, use the command:

```
awplus# debug ssh server full
```

To disable SSH server debugging, use the command:

```
awplus# no debug ssh server
```

Related Commands `debug ssh client`
`show ssh server`
`undebug ssh server`

service ssh

This command enables the Secure Shell server on the device. Once enabled, connections coming from SSH clients are accepted.

SSH server needs a host key before it starts. If an SSHv2 host key does not exist, then this command fails. If SSHv1 is enabled but a host key for SSHv1 does not exist, then SSH service is unavailable for version 1.

The **no** variant of this command disables the Secure Shell server. When the Secure Shell server is disabled, connections from SSH, SCP, and SFTP clients are not accepted. This command does not affect existing SSH sessions. To terminate existing sessions, use the **clear ssh** command.

Syntax `service ssh [ip|ipv6]`
`no service ssh [ip|ipv6]`

Default The Secure Shell server is disabled by default. Both IPv4 and IPv6 Secure Shell server are enabled when you issue **service ssh** without specifying the optional **ip** or **ipv6** parameters.

Mode Global Configuration

Examples To enable both the IPv4 and the IPv6 Secure Shell server, use the commands:

```
awplus# configure terminal
awplus(config)# service ssh
```

To enable the IPv4 Secure Shell server only, use the commands:

```
awplus# configure terminal
awplus(config)# service ssh ip
```

To enable the IPv6 Secure Shell server only, use the commands:

```
awplus# configure terminal
awplus(config)# service ssh ipv6
```

To disable both the IPv4 and the IPv6 Secure Shell server, use the commands:

```
awplus# configure terminal
awplus(config)# no service ssh
```

To disable the IPv4 Secure Shell server only, use the commands:

```
awplus# configure terminal
awplus(config)# no service ssh ip
```

To disable the IPv6 Secure Shell server only, use the commands:

```
awplus# configure terminal
awplus(config)# no service ssh ipv6
```

Related Commands [crypto key generate hostkey](#)
[show running-config ssh](#)
[show ssh server](#)
[ssh server allow-users](#)
[ssh server deny-users](#)

show banner login

This command displays the banner message configured on the device. The banner message is displayed to the remote user before user authentication starts.

Syntax `show banner login`

Mode User Exec, Privileged Exec, Global Configuration, Interface Configuration, Line Configuration

Example To display the current login banner message, use the command:

```
awplus# show banner login
```

Related Commands [banner login \(SSH\)](#)

show crypto key hostkey

This command displays the SSH host keys generated by RSA and DSA algorithm.

A host key pair (public and private keys) is needed to enable SSH server. The private key remains on the device secretly. The public key is copied to SSH clients to identify the server

Syntax `show crypto key hostkey [dsa|rsa|rsa1]`

Parameter	Description
dsa	Displays the DSA algorithm public key.
rsa	Displays the RSA algorithm public key for SSH version 2 connections.
rsa1	Displays the RSA algorithm public key for SSH version 1 connections.

Mode Privileged Exec and Global Configuration

Output Figure 66-1: Example output from the `show crypto key hostkey` command

Type	Bits	Fingerprint
rsa	2058	4e:7d:1d:00:75:79:c5:cb:c8:58:2e:f9:29:9c:1f:48
dsa	1024	fa:72:3d:78:35:14:cb:9a:1d:ca:1c:83:2c:7d:08:43
rsa1	1024	e2:1c:c8:8b:d8:6e:19:c8:f4:ec:00:a2:71:4e:85:8b

Table 66-1: Parameters in output of the `show crypto key hostkey` command

Parameter	Description
Type	Algorithm used to generate the key.
Bits	Length in bits of the key.
Fingerprint	Checksum value for the public key.

Examples To show the public keys generated on the device for SSH server, use the command:

```
awplus# show crypto key hostkey
```

To display the RSA public key of the SSH server, use the command:

```
awplus# show crypto key hostkey rsa
```

Related Commands [crypto key destroy hostkey](#)
[crypto key generate hostkey](#)

show crypto key pubkey-chain knownhosts

This command displays the list of public keys maintained in the known host database on the device.

Syntax `show crypto key pubkey-chain knownhosts [<1-65535>]`

Parameter	Description
<1-65535>	Key identifier for a specific key. Displays the public key of the entry if specified.

Default Display all keys.

Mode Privileged Exec

Output Figure 66-2: Example output from the **show crypto key public-chain knownhosts** command

No	Hostname	Type	Fingerprint
1	172.16.23.1	rsa	c8:33:b1:fe:6f:d3:8c:81:4e:f7:2a:aa:a5:be:df:18
2	172.16.23.10	rsa	c4:79:86:65:ee:a0:1d:a5:6a:e8:fd:1d:d3:4e:37:bd
3	3ffe::1	dsa	61:90:92:ba:da:33:b8:08:52:32:08:3b:f2:48:1b:19
4	5ffe:1053:ac21:ff00:0101:bcdF:ffff:0001	rsa1	af:4e:b4:a2:26:24:6d:65:20:32:d9:6f:32:06:ba:57

Table 66-2: Parameters in the output of the **show crypto key public-chain knownhosts** command

Parameter	Description
No	Number ID of the key.
Hostname	Host name of the known SSH server.
Type	The algorithm used to generate the key.
Fingerprint	Checksum value for the public key.

Examples To display public keys of known SSH servers, use the command:

```
awplus# show crypto key pubkey-chain knownhosts
```

To display the key data of the first entry in the known host data, use the command:

```
awplus# show crypto key pubkey-chain knownhosts 1
```

Related Commands [crypto key pubkey-chain knownhosts](#)

show crypto key pubkey-chain userkey

This command displays the public keys registered with the SSH server for SSH users. These keys allow remote users to access the device using public key authentication. By using public key authentication, users can access the SSH server without providing password.

Syntax `show crypto key pubkey-chain userkey <username> [<1-65535>]`

Parameter	Description
<username>	User name of the remote SSH user whose keys you wish to display. The username must begin with a letter. Valid characters are all numbers, letters, and the underscore, hyphen and full stop symbols.
<1-65535>	Key identifier for a specific key.

Default Display all keys.

Mode Privileged Exec

Output Figure 66-3: Example output from the `show crypto key public-chain userkey` command

No	Type	Bits	Fingerprint
1	dsa	1024	2b:cc:df:a8:f8:2e:8f:a4:a5:4f:32:ea:67:29:78:fd
2	rsa	2048	6a:ba:22:84:c1:26:42:57:2c:d7:85:c8:06:32:49:0e

Table 66-3: Parameters in the output of the `show crypto key userkey` command

Parameter	Description
No	Number ID of the key.
Type	The algorithm used to generate the key.
Bits	Length in bits of the key.
Fingerprint	Checksum value for the key.

To display the public keys for the user `manager` that are registered with the SSH server, use the command:

```
awplus# show crypto key pubkey-chain userkey manager
```

Related Commands `crypto key pubkey-chain userkey`

show crypto key userkey

This command displays the public keys created on this device for the specified SSH user.

Syntax `show crypto key userkey <username> [dsa|rsa|rsa1]`

Parameter	Description
<username>	User name of the local SSH user whose keys you wish to display. The username must begin with a letter. Valid characters are all numbers, letters, and the underscore, hyphen and full stop symbols.
dsa	Displays the DSA public key.
rsa	Displays the RSA public key used for SSH version 2 connections.
rsa1	Displays the RSA key used for SSH version 1 connections.

Mode Privileged Exec

Output Figure 66-4: Example output from the `show crypto key userkey` command

Type	Bits	Fingerprint
rsa	2048	e8:d6:1b:c0:f4:b6:e6:7d:02:2e:a9:d4:a1:ca:3b:11
rsa1	1024	12:25:60:95:64:08:8e:a1:8c:3c:45:1b:44:b9:33:9b

Table 66-4: Parameters in the output of the `show crypto key userkey` command

Parameter	Description
Type	The algorithm used to generate the key.
Bits	Length in bits of the key.
Fingerprint	Checksum value for the key.

Examples To show the public key generated for the user, use the command:

```
awplus# show crypto key userkey manager
```

To store the RSA public key generated for the user manager to the file "user.pub", use the command:

```
awplus# show crypto key userkey manager rsa > manager-rsa.pub
```

Related Commands `crypto key generate userkey`

show running-config ssh

This command displays the current running configuration of Secure Shell (SSH).

Syntax `show running-config ssh`

Mode Privileged Exec

Output Figure 66-5: Example output from the `show running-config ssh` command

```
!
ssh server session-timeout 600
ssh server login-timeout 30
ssh server allow-users manager 192.168.1.*
ssh server allow-users john
ssh server deny-user john*.a-company.com
ssh server
```

Table 66-5: Parameters in the output of the `show running-config ssh` command

Parameter	Description
<code>ssh server</code>	SSH server is enabled.
<code>ssh server v2</code>	SSH server is enabled and only support SSHv2.
<code>ssh server <port></code>	SSH server is enabled and listening on the specified TCP port.
<code>no ssh server scp</code>	SCP service is disabled.
<code>no ssh server sftp</code>	SFTP service is disabled.
<code>ssh server session-timeout</code>	Configure the server session timeout.
<code>ssh server login-timeout</code>	Configure the server login timeout.
<code>ssh server max-startups</code>	Configure the maximum number of concurrent sessions waiting authentication.
<code>no ssh server authentication password</code>	Password authentication is disabled.
<code>no ssh server authentication publickey</code>	Public key authentication is disabled.
<code>ssh server allow-users</code>	Add the user (and hostname) to the allow list.
<code>ssh server deny-users</code>	Add the user (and hostname) to the deny list.

Example To display the current configuration of SSH, use the command:

```
awplus# show running-config ssh
```

Related Commands [service ssh](#)
[show ssh server](#)

show ssh

This command displays the active SSH sessions on the device, both incoming and outgoing.

Syntax `show ssh`

Mode Privileged Exec

Output Figure 66-6: Example output from the `show ssh` command

```
Secure Shell Sessions:
ID  Type Mode  Peer Host      Username      State          Filename
-----
414 ssh  server 172.16.23.1   root          open
456 ssh  client 172.16.23.10 manager       user-auth
459 scp  client 172.16.23.12 root          download       550dev_.awd
463 ssh  client 5ffe:33fe:5632:ffbb:bc35:ddee:0101:ac51
                                manager       user-auth
```

Table 66-6: Parameters in the output of the `show ssh` command

Parameter	Description
ID	Unique identifier for each SSH session.
Type	Session type; either SSH, SCP, or SFTP.
Mode	Whether the device is acting as an SSH client (client) or SSH server (server) for the specified session.
Peer Host	The hostname or IP address of the remote server or client.
Username	Login user name of the server.
State	The current state of the SSH session. One of: <ul style="list-style-type: none"> connecting The device is looking for a remote server. connected The device is connected to the remote server. accepted The device has accepted a new session. host-auth host-to-host authentication is in progress. user-auth User authentication is in progress. authenticated User authentication is complete. open The session is in progress. download The user is downloading a file from the device. upload The user is uploading a file from the device. closing The user is terminating the session. closed The session is closed.
Filename	Local filename of the file that the user is downloading or uploading.

Example To display the current SSH sessions on the device, use the command:

```
awplus# show ssh
```

Related Commands `clear ssh`

show ssh client

This command displays the current configuration of the Secure Shell client.

Syntax `show ssh client`

Mode Privileged Exec

Output Figure 66-7: Example output from the `show ssh client` command

```
Secure Shell Client Configuration
-----
Port                : 22
Version             : 2,1
Connect Timeout    : 30 seconds
Session Timeout    : 0 (off)
Debug               : NONE
```

Table 66-7: Parameters in the output of the `show ssh client` command

Parameter	Description
Port	SSH server TCP port where the SSH client connects to. The default is port 22.
Version	SSH server version; either "1", "2" or "2,1".
Connect Timeout	Time in seconds that the SSH client waits for an SSH session to establish. If the value is 0, the connection is terminated when it reaches the TCP timeout.
Debug	Whether debugging is active on the client.

Example To display the current configuration for SSH clients on the login shell, use the command:

```
awplus# show ssh client
```

Related Commands `show ssh server`

show ssh server

This command displays the current configuration of the Secure Shell server.

Note that changes to the SSH configuration affects only new SSH sessions coming from remote hosts, and does not affect existing sessions.

Syntax `show ssh server`

Mode Privileged Exec

Output Figure 66-8: Example output from the `show ssh server` command

```
Secure Shell Server Configuration
-----
SSH Server           : Enabled
Port                 : 22
Version              : 2
Services             : scp, sftp
User Authentication  : publickey, password
Idle Timeout         : 60 seconds
Maximum Startups     : 10
Debug                : NONE
```

Table 66-8: Parameters in the output of the `show ssh server` command

Parameter	Description
SSH Server	Whether the Secure Shell server is enabled or disabled.
Port	TCP port where the Secure Shell server listens for connections. The default is port 22.
Version	SSH server version; either "1", "2" or "2,1".
Services	List of the available Secure Shell service; one or more of SHELL, SCP or SFTP.
Authentication	List of available authentication methods.
Login Timeout	Time (in seconds) that the SSH server will wait the SSH session to establish. If the value is 0, the client login will be terminated when TCP timeout reaches.
Idle Timeout	Time (in seconds) that the SSH server will wait to receive data from the SSH client. The server disconnects if this timer limit is reached. If set at 0, the idle timer remains off.
Maximum Startups	The maximum number of concurrent connections that are waiting authentication. The default is 10.
Debug	Whether debugging is active on the server.

Example To display the current configuration of the Secure Shell server, use the command:

```
awplus# show ssh server
```

Related Commands `show ssh`
`show ssh client`

show ssh server allow-users

This command displays the user entries in the allow list of the SSH server.

Syntax `show ssh server allow-users`

Mode Privileged Exec

Output Figure 66-9: Example output from the `show ssh server allow-users` command

Username	Remote Hostname (pattern)
awplus	192.168.*
john	
manager	*.alliedtelesis.com

Table 66-9: Parameters in the output of the `show ssh server allow-users` command

Parameter	Description
Username	User name that is allowed to access the SSH server.
Remote Hostname (pattern)	IP address or hostname pattern of the remote client. The user is allowed requests from a host that matches this pattern. If no hostname is specified, the user is allowed from all hosts.

Example To display the user entries in the allow list of the SSH server, use the command:

```
awplus# show ssh server allow-users
```

Related Commands `ssh server allow-users`
`ssh server deny-users`

show ssh server deny-users

This command displays the user entries in the deny list of the SSH server. The user in the deny list is rejected to access the SSH server. If a user is not included in the access list of the SSH server, the user is also rejected.

Syntax `show ssh server deny-users`

Mode Privileged Exec

Output Figure 66-10: Example output from the `show ssh server deny-user` command

Username	Remote Hostname (pattern)
john	*.b-company.com
manager	192.168.2.*

Table 66-10: Parameters in the output of the `show ssh server deny-user` command

Parameter	Description
Username	The user that this rule applies to.
Remote Hostname (pattern)	IP address or hostname pattern of the remote client. The user is denied requests from a host that matches this pattern. If no hostname is specified, the user is denied from all hosts.

Example To display the user entries in the deny list of the SSH server, use the command:

```
awplus# show ssh server deny-users
```

Related Commands [ssh server allow-users](#)
[ssh server deny-users](#)

ssh

This command initiates a Secure Shell connection to a remote SSH server.

If the server requests a password for the user login, the user needs to type in the correct password on "Password:" prompt.

SSH client identifies the remote SSH server by its public key registered on the client device. If the server identification is changed, server verification fails. If the public key of the server has been changed, it is required that the public key of the server should be explicitly added to the known host database.

Note Note that any hostname specified with ssh cannot begin with a hyphen (-) character.



Syntax `ssh [ip|ipv6][{user <username>|port <1-65535>|version {1|2}}] <hostname> [<line>]`

Parameter	Description
<code>ip</code>	Specify IPv4 SSH.
<code>ipv6</code>	Specify IPv6 SSH.
<code>user</code>	Login user. If user is specified, the username is used for login to the remote SSH server when user authentication is required. Otherwise the current user name is used. <username> User name to login on the remote server.
<code>port</code>	SSH server port. If port is specified, the SSH client connects to the remote SSH server with the specified TCP port. Other- wise, the client port configured by "ssh client" command or the default TCP port (22) is used. <1-65535> TCP port.
<code>version</code>	SSH client version. If version is specified, the SSH client supports only the specified SSH version. By default, SSH client uses SSHv2 first. If the server does not support SSHv2, it will try SSHv1. The default version can be configured by "ssh client" command. 1 Use SSH version 1. 2 Use SSH version 2.
<code><hostname></code>	IPv4/IPv6 address or hostname of a remote server in the format a . b . c . d for an IPv4 address, or in the format x : x : : x : x for an IPv6 address corresponding to the ip or ipv6 optional keywords used. Note that any hostname specified with ssh cannot begin with a hyphen (-) character.
<code><line></code>	Command to execute on the remote server. If a command is specified, the command is executed on the remote SSH server and the session is disconnected when the remote command finishes.

Mode User Exec and Privileged Exec

Examples To login to the remote SSH server at 192.0.2.5, use the command:

```
awplus# ssh ip 192.0.2.5
```

To login to the remote SSH server at 192.0.2.5 as user **manager**, use the command:

```
awplus# ssh ip user manager 192.0.2.5
```

To login to the remote SSH server at 192.0.2.5 that is listening TCP port 2000, use the command:

```
awplus# ssh port 2000 192.0.2.5
```

To login to the remote SSH server with **example_host** using IPv6 session, use the command:

```
awplus# ssh ipv6 example_host
```

To run the **cmd** command on the remote SSH server at 192.0.2.5, use the command:

```
awplus# ssh ip 192.0.2.5 cmd
```

Related Commands [crypto key generate userkey](#)
[crypto key pubkey-chain knownhosts](#)
[debug ssh client](#)
[ssh client](#)

ssh client

This command modifies the default configuration parameters of the Secure Shell (SSH) client. The configuration is used for any SSH client on the device to connect to remote SSH servers. Any parameters specified on SSH client explicitly override the default configuration parameters.

The change affects the current user shell only. When the user exits the login session, the configuration does not persist. This command does not affect existing SSH sessions.

The **no** variant of this command resets configuration parameters of the Secure Shell (SSH) client changed by the **ssh client** command, and restores the default values.

This command does not affect the existing SSH sessions.

Syntax `ssh client {port <1-65535>|version {1|2}|session-timeout <0-3600>|connect-timeout <1-600>}`

`no ssh client {port|version|session-timeout|connect-timeout}`

Parameter	Description				
port	<p>The default TCP port of the remote SSH server. If an SSH client specifies an explicit port of the server, it overrides the default TCP port.</p> <p>Default: 22</p> <hr/> <p><1-65535> TCP port number.</p>				
version	<p>The SSH version used by the client for SSH sessions. The SSH client supports both version 2 and version 1</p> <p>Default: version 2</p> <p>Note: SSH version 2 is the default SSH version. SSH client supports SSH version 1 if SSH version 2 is not configured using a ssh version command.</p> <hr/> <table> <tr> <td>1</td> <td>SSH clients on the device supports SSH version 1 only.</td> </tr> <tr> <td>2</td> <td>SSH clients on the device supports SSH version 2 only</td> </tr> </table>	1	SSH clients on the device supports SSH version 1 only.	2	SSH clients on the device supports SSH version 2 only
1	SSH clients on the device supports SSH version 1 only.				
2	SSH clients on the device supports SSH version 2 only				
session-timeout	<p>The global session timeout for SSH sessions. If the session timer lapses since the last time an SSH client received data from the remote server, the session is terminated. If the value is 0, then the client does not terminate the session. Instead, the connection is terminated when it reaches the TCP timeout.</p> <p>Default: 0 (session timer remains off)</p> <hr/> <p><0-3600> Timeout in seconds.</p>				
connect-timeout	<p>The maximum time period that an SSH session can take to become established. The SSH client terminates the SSH session if this timeout expires and the session is still not established.</p> <p>Default: 30</p> <hr/> <p><1-600> Timeout in seconds.</p>				

Mode Privileged Exec

Examples To configure the default TCP port for SSH clients to 2200, and the session timer to 10 minutes, use the command:

```
awplus# ssh client port 2200 session-timeout 600
```

To configure the connect timeout of SSH client to 10 seconds, use the command:

```
awplus# ssh client connect-timeout 10
```

To restore the connect timeout to its default, use the command:

```
awplus# no ssh client connect-timeout
```

Related Commands `show ssh client`
`ssh`

ssh server

This command modifies the configuration of the SSH server. Changing these parameters affects new SSH sessions connecting to the device.

The **no** variant of this command restores the configuration of a specified parameter to its default value. The change affects the SSH server immediately if the server is running. Otherwise, the configuration is used when the server starts.

To enable the SSH server, use the [service ssh](#) command.

Syntax

```
ssh server {[v1v2|v2only] | <1-65535>}
ssh server {[session-timeout <0-3600>} [login-timeout <1-600>}
           [max-startups <1-128>]}
no ssh server {[session-timeout] [login-timeout] [max-startups]}
```

Parameter	Description
v1v2	Supports both SSHv2 and SSHv1 client connections. Default: v1v2
v2only	Supports SSHv2 client connections only.
<1-65535>	The TCP port number that the server listens to for incoming SSH sessions. Default: 22
session-timeout	There is a maximum time period that the server waits before deciding that a session is inactive and should be terminated. The server considers the session inactive when it has not received any data from the client, and when the client does not respond to keep alive messages. Default: 0 (session timer remains off)
	<0-3600> Timeout in seconds.
login-timeout	The maximum time period the server waits before disconnecting an unauthenticated client. Default: 60
	<1-600> Timeout in seconds.
max-startups	The maximum number of concurrent unauthenticated connections the server accepts. When the number of SSH connections awaiting authentication reaches the limit, the server drops any additional connections until authentication succeeds or the login timer expires for a connection. Default: 10
	<1-128> Number of sessions.

Mode Global Configuration

Examples To configure the session timer of SSH server to 10 minutes (600 seconds), use the commands:

```
awplus# configure terminal
awplus(config)# ssh server login-timeout 600
```

To configure the login timeout of SSH server to 30 seconds, use the commands:

```
awplus# configure terminal
awplus(config)# ssh server login-timeout 30
```

To limit the number of SSH client connections waiting authentication from SSH server to 3, use the commands:

```
awplus# configure terminal
awplus(config)# ssh server max-startups
```

To set max-startups parameters of SSH server to the default configuration, use the commands:

```
awplus# configure terminal
awplus(config)# no ssh server max-startups
```

To support the Secure Shell server with TCP port 2200, use the commands:

```
awplus# configure terminal
awplus(config)# ssh server 2200
```

To force the Secure Shell server to support SSHv2 only, use the commands:

```
awplus# configure terminal
awplus(config)# ssh server v2only
```

To support both SSHv2 and SSHv1, use the commands:

```
awplus# configure terminal
awplus(config)# ssh server v1v2
```

Related Commands [show ssh server](#)
[ssh client](#)

ssh server allow-users

This command adds a username pattern to the allow list of the SSH server. If the user of an incoming SSH session matches the pattern, the session is accepted.

When there are no registered users in the server's database of allowed users, the SSH server does not accept SSH sessions even when enabled.

SSH server also maintains the deny list. The server checks the user in the deny list first. If a user is listed in the deny list, then the user access is denied even if the user is listed in the allow list.

The **no** variant of this command deletes a username pattern from the allow list of the SSH server. To delete an entry from the allow list, the username and hostname pattern should match exactly with the existing entry.

Syntax `ssh server allow-users <username-pattern> [<hostname-pattern>]`
`no ssh server allow-users <username-pattern> [<hostname-pattern>]`

Parameter	Description
<code><username-pattern></code>	The username pattern that users can match to. An asterisk acts as a wildcard character that matches any string of characters.
<code><hostname-pattern></code>	The host name pattern that hosts can match to. If specified, the server allows the user to connect only from hosts matching the pattern. An asterisk acts as a wildcard character that matches any string of characters.

Mode Global Configuration

Example To allow the user `john` to create an SSH session from any host, use the commands:

```
awplus# configure terminal
awplus(config)# ssh server allow-users john
```

To allow the user `john` to create an SSH session from a range of IP address (from 192.168.1.1 to 192.168.1.255), use the commands:

```
awplus# configure terminal
awplus(config)# ssh server allow-users john 192.168.1.*
```

To allow the user `john` to create a SSH session from `a-company.com` domain, use the commands:

```
awplus# configure terminal
awplus(config)# ssh server allow-users john *.a-company.com
```

To delete the existing user entry `john 192.168.1.*` in the allow list, use the commands:

```
awplus# configure terminal
awplus(config)# no ssh server allow-users john 192.168.1.*
```

Related Commands [show running-config ssh](#)
[show ssh server allow-users](#)
[ssh server deny-users](#)

ssh server authentication

This command enables RSA public-key or password user authentication for SSH Server. Apply the **password** keyword with the **ssh server authentication** command to enable password authentication for users. Apply the **publickey** keyword with the **ssh server authentication** command to enable RSA public-key authentication for users.

Use the **no** variant of this command to disable RSA public-key or password user authentication for SSH Server. Apply the **password** keyword with the **no ssh authentication** command to disable password authentication for users. Apply the required **publickey** keyword with the **no ssh authentication** command to disable RSA public-key authentication for users.

Syntax `ssh server authentication {password|publickey}`
`no ssh server authentication {password|publickey}`

Parameter	Description
<code>password</code>	Specifies user password authentication for SSH server.
<code>publickey</code>	Specifies user publickey authentication for SSH server.

Default Both RSA public-key authentication and password authentication are enabled by default.

Mode Global Configuration

Usage For password authentication to authenticate a user, password authentication for a user must be registered in the local user database or on an external RADIUS server, before using the **ssh server authentication password** command.

For RSA public-key authentication to authenticate a user, a public key must be added for the user, before using the **ssh server authentication publickey** command.

Example To enable `password` authentication for users connecting through SSH, use the commands:

```
awplus# configure terminal
awplus(config)# ssh server authentication password
```

To enable `publickey` authentication for users connecting through SSH, use the commands:

```
awplus# configure terminal
awplus(config)# ssh server authentication publickey
```

To disable `password` authentication for users connecting through SSH, use the commands:

```
awplus# configure terminal
awplus(config)# no ssh server authentication password
```

To disable `publickey` authentication for users connecting through SSH, use the commands:

```
awplus# configure terminal
awplus(config)# no ssh server authentication publickey
```

Related Commands [crypto key pubkey-chain userkey](#)
[service ssh](#)
[show ssh server](#)

ssh server deny-users

This command adds a username pattern to the deny list of the SSH server. If the user of an incoming SSH session matches the pattern, the session is rejected.

SSH server also maintains the allow list. The server checks the user in the deny list first. If a user is listed in the deny list, then the user access is denied even if the user is listed in the allow list.

If a hostname pattern is specified, the user is denied from the hosts matching the pattern.

The **no** variant of this command deletes a username pattern from the deny list of the SSH server. To delete an entry from the deny list, the username and hostname pattern should match exactly with the existing entry.

Syntax `ssh server deny-users <username-pattern> [<hostname-pattern>]`
`no ssh server deny-users <username-pattern> [<hostname-pattern>]`

Parameter	Description
<code><username-pattern></code>	The username pattern that users can match to. The username must begin with a letter. Valid characters are all numbers, letters, and the underscore, hyphen, full stop and asterisk symbols. An asterisk acts as a wildcard character that matches any string of characters.
<code><hostname-pattern></code>	The host name pattern that hosts can match to. If specified, the server denies the user only when they connect from hosts matching the pattern. An asterisk acts as a wildcard character that matches any string of characters.

Mode Global Configuration

Example To deny the user `john` to access SSH login from any host, use the commands:

```
awplus# configure terminal
awplus(config)# ssh server deny-users john
```

To deny the user `john` to access SSH login from a range of IP address (from 192.168.2.1 to 192.168.2.255), use the commands:

```
awplus# configure terminal
awplus(config)# ssh server deny-users john 192.168.2.*
```

To deny the user `john` to access SSH login from `b-company.com` domain, use the commands:

```
awplus# configure terminal
awplus(config)# ssh server deny-users john*.b-company.com
```

To delete the existing user entry `john 192.168.2.*` in the deny list, use the commands:

```
awplus# configure terminal
awplus(config)# no ssh server deny-users john 192.168.2.*
```

Related Commands [show running-config ssh](#)
[show ssh server deny-users](#)
[ssh server allow-users](#)

ssh server scp

This command enables the Secure Copy (SCP) service on the SSH server. Once enabled, the server accepts SCP requests from remote clients.

You must enable the SSH server as well as this service before the device accepts SCP connections. The SCP service is enabled by default as soon as the SSH server is enabled.

The **no** variant of this command disables the SCP service on the SSH server. Once disabled, SCP requests from remote clients are rejected.

Syntax `ssh server scp`
`no ssh server scp`

Mode Global Configuration

Examples To enable the SCP service, use the commands:

```
awplus# configure terminal
awplus(config)# ssh server scp
```

To disable the SCP service, use the commands:

```
awplus# configure terminal
awplus(config)# no ssh server scp
```

Related Commands [show running-config ssh](#)
[show ssh server](#)

ssh server sftp

This command enables the Secure FTP (SFTP) service on the SSH server. Once enabled, the server accepts SFTP requests from remote clients.

You must enable the SSH server as well as this service before the device accepts SFTP connections. The SFTP service is enabled by default as soon as the SSH server is enabled. If the SSH server is disabled, SFTP service is unavailable.

The **no** variant of this command disables SFTP service on the SSH server. Once disabled, SFTP requests from remote clients are rejected.

Syntax `ssh server sftp`
`no ssh server sftp`

Mode Global Configuration

Examples To enable the SFTP service, use the commands:

```
awplus# configure terminal
awplus(config)# ssh server sftp
```

To disable the SFTP service, use the commands:

```
awplus# configure terminal
awplus(config)# no ssh server sftp
```

Related Commands [show running-config ssh](#)
[show ssh server](#)

undebug ssh client

This command applies the functionality of the [no debug ssh client command on page 66.11](#).

undebug ssh server

This command applies the functionality of the [no debug ssh server command on page 66.12](#).

Chapter 67: DHCP Snooping Introduction



Introduction.....	67.2
DHCP Snooping.....	67.2
DHCP Snooping Database.....	67.3
DHCP Option 82.....	67.4
Traffic Filtering with DHCP Snooping.....	67.6
ARP Security.....	67.8
MAC Address Verification.....	67.8
DHCP Snooping Violations.....	67.8
Interactions with Other Features.....	67.9
Configuration.....	67.10
Configure DHCP Snooping.....	67.10
Disabling DHCP Snooping.....	67.14
Related Features.....	67.14

Introduction

This chapter provides information about DHCP snooping, support for it on this switch, and how to configure it.

For detailed descriptions of the commands used to configure DHCP snooping, see [Chapter 68, DHCP Snooping Commands](#); for related ACL commands, see [Chapter 50, IPv4 Access Control List \(ACL\) Commands](#). For information about Dynamic Host Configuration protocol and how to configure it, see [Chapter 75, Dynamic Host Configuration Protocol \(DHCP\) Introduction](#) and [Chapter 76, Dynamic Host Configuration Protocol \(DHCP\) Commands](#).

DHCP Snooping

DHCP snooping provides an extra layer of security on the switch via dynamic IP source filtering. DHCP snooping filters out traffic received from unknown, or 'untrusted' ports, and builds and maintains a DHCP snooping database.

Dynamic Host Configuration Protocol (DHCP) dynamically assigns IP addresses to client devices. The use of dynamically assigned addresses requires traceability, so that a service provider can determine which clients own a particular IP address at a certain time.

With DHCP snooping, IP sources are dynamically verified, and filtered accordingly. IP packets that are not sourced from recognized IP addresses can be filtered out. This ensures the required traceability.

With DHCP snooping, an administrator can control port-to-IP connectivity by:

- permitting port access to specified IP addresses only
- permitting port access to DHCP issued IP addresses only
- dictating the number of IP clients on any given port
- passing location information about an IP client to the DHCP server
- permitting only known IP clients to ARP

Ports on the switch are classified as either trusted or untrusted:

- Trusted ports receive only messages from within your network.
- Untrusted ports receive messages from outside your network.

DHCP snooping blocks unauthorized IP traffic from untrusted ports, and prevents it from entering the trusted network. It validates DHCP client packets from untrusted ports and forwards them to trusted ports in the VLAN.

On this switch, DHCP snooping is disabled by default, and can be enabled on per-VLAN basis to operate over switch ports and over static and dynamic (LACP) link aggregators (channel groups).

DHCP Snooping Database

When you enable DHCP snooping, the switch intercepts all DHCP packets it receives, and sends them to the Central Processing Unit (CPU), where they are verified. The DHCP snooping database stores and maintains this information. The database contains entries for:

- current IP address leases dynamically allocated by a DHCP server
- static or dynamic entries added from the command line—typically used to add a DHCP snooping entry for a client that has a preconfigured IP address on an untrusted port

Database backup The switch periodically saves the dynamic entries in the DHCP snooping database to a hidden file (`.dhcp.dsn.gz`) in Non-Volatile Storage (NVS), or can be configured to save it to Flash memory or to an SD card. If such a database file exists, it is loaded when the switch starts up with DHCP snooping enabled, or when DHCP snooping is subsequently enabled.

Lease entries Each entry in the database corresponds to a DHCP IP address lease.

For dynamic entries added automatically by DHCP snooping, each entry contains the following information:

- the IP address that was allocated to that client
- the MAC address of the client device
- the time until expiry
- the VLAN to which the client is attached
- the port to which the client is attached
- the IP address of the DHCP server

For static entries added from the command line, each entry contains the following subset of information:

- the IP address allocated to the client
- the MAC address of the client device (optional)
- the VLAN to which the client is attached
- the port to which the client is attached

Each entry also shows its source: Dynamic or Static.

On this switch, the maximum number of lease entries that can be stored in the DHCP snooping database for each port can be configured—the default is 1.

Expired entries For dynamic entries, the switch receives expiry information with the client lease information in DHCP packets. Entries expire when the time left to expiry is 0 seconds. Expired entries are automatically deleted from the database. Static entries have no expiry information, and are not checked. All dynamic entries in the database are written to the backup file. Whenever DHCP snooping is enabled, the DHCP snooping database is repopulated from the backup file and any static entries in the start-up configuration file. Any entries present in the backup file that have expired are ignored.

DHCP Option 82

If the switch is at the edge of the network, it can be configured to insert DHCP Option 82 information into client-originated BOOTP/DHCP packets that it is forwarding to a DHCP server. The switch also removes Option 82 information from BOOTP reply packets destined for an untrusted port if the DHCP client hardware is directly attached to a port on the switch.

DHCP servers that are configured to recognize Option 82 may use the information to implement IP address or other parameter assignment policies, based on the network location of the client device.

When Option 82 information for DHCP snooping is enabled, the switch inserts Option 82 information into BOOTP request packets received from an untrusted port. The switch inserts the following Option 82 information:

- **Remote-ID:** this specifies the MAC address of the switch (sub-option1).
- **Circuit-ID:** this specifies the switch port and VLAN-ID that the client-originated DHCP packet was received on (sub-option2).
- **Subscriber-ID (optional):** this is a string of up to 50 characters that differentiates or groups client ports on the switch (sub-option 6).

Support on this switch

This switch inserts Option 82 (agent option) information into DHCP packets received through untrusted ports, and removes it from DHCP packets transmitted through untrusted ports. This is enabled by default, and can be disabled if required. Subscriber IDs can be configured for ports, and if they have been configured, they are inserted in DHCP packets as part of the Option 82 information.

Regardless of whether Option 82 is enabled for DHCP snooping, if the switch receives a BOOTP/DHCP request packet on a trusted port, and the packet contains Option 82 information, it does not update the Option 82 information for the receiver port. By default, if it receives a DHCP request packet containing Option 82 information on an untrusted port, it drops the packet. However, if the switch is connected via untrusted ports to edge switches that insert DHCP Option 82 information into DHCP packets, you may need to allow these DHCP packets through the untrusted ports—the switch can be configured to forward these packets.

Note that the Option 82 agent information inserted by the DHCP snooping differs from the information added by DHCP Relay (see [“Configuring the DHCP Relay Agent” on page 75.6](#)). The switch cannot be configured to use both the DHCP relay agent option and DHCP snooping.

Operation Figure 67-1 shows DHCP packet flow between DHCP clients and server, where:

- Switch A has DHCP snooping enabled. The DHCP server is connected to a trusted port on Switch A; DHCP clients and Switch B are connected to untrusted ports.
- Switch A is configured to add and remove DHCP Option 82 information (`ip dhcp snooping agent-option` command on page 68.9).
- Switch A is configured to forward DHCP packets that already contain Option 82 information without changing it (`ip dhcp snooping agent-option allow-untrusted` command on page 68.10).
- Switch B is Layer 2 switching traffic from downstream DHCP clients, and adds and removes DHCP Option 82 information.

Figure 67-1: DHCP packet flow with DHCP snooping and Option 82 (agent option)

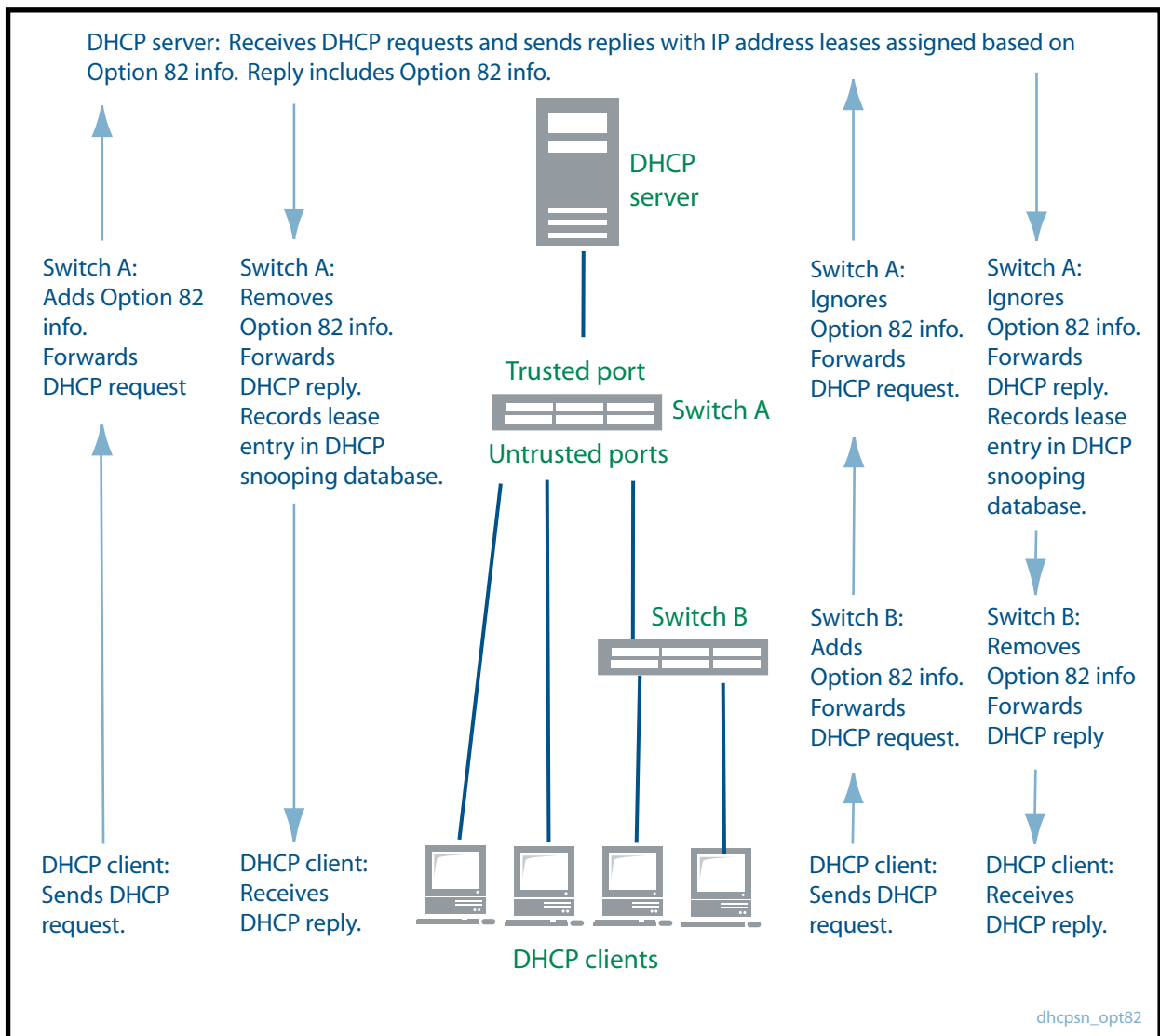

For more information about Option 82, see RFC 3046, DHCP Relay Agent Information Option.

Traffic Filtering with DHCP Snooping

DHCP filtering prevents IP addresses from being falsified or 'spoofed'. This guarantees that customers cannot avoid detection by spoofing IP addresses that are not actually allocated to them. With DHCP filtering, the switch permits packets to enter over a specific port if their source IP address is currently allocated to a client connected to that port.

Support on this switch

On this switch, Access Control Lists (ACLs) based on DHCP snooping can be used with access groups to filter IP packets. For instance, IP traffic on untrusted ports can be limited to packets matching valid DHCP lease information stored in the DHCP snooping database. Quality of Service (QoS) configuration can also be applied to these ACLs.

The DHCP snooping feature is enabled or disabled per VLAN, and several of the related configuration settings are applied per port. If there are multiple VLANs on a port, all the VLANs will be subject to the same per-port settings.

Operation

Table 67-1 on page 67.7 shows the filtering that is applied by DHCP snooping on a switch with the following DHCP filtering configuration for untrusted ports:

- DHCP snooping is enabled on all VLANs ([service dhcp-snooping command on page 68.21](#), [ip dhcp snooping command on page 68.8](#))
- ARP security ([arp security command on page 68.2](#)) is enabled on all VLANs
- MAC address verification is enabled on the switch ([ip dhcp snooping verify mac-address command on page 68.18](#); enabled by default), and all DHCP clients are directly connected to the switch.
- Access Control Lists allow IP packets that match the source IP address and MAC address of a valid lease entry in the DHCP snooping database, and deny other IP packets ([access-list commands in Chapter 50, IPv4 Access Control List \(ACL\) Commands](#)).
- DHCP requests containing Option 82 info are not allowed ([ip dhcp snooping agent-option allow-untrusted command on page 68.10](#) this is disabled by default).
- Log messages and SNMP notifications are enabled for DHCP snooping and ARP security violations ([ip dhcp snooping violation command on page 68.19](#), [arp security violation command on page 68.3](#), [snmp-server enable trap command on page 78.16](#)).

Table 67-1: DHCP filtering on the switch

When the switch ...	And ...	Then the switch ...
DHCP packets		
Receives a DHCP BOOTP packet on a trusted port		Forwards the DHCP packet.
	The packet contains a valid IP address lease for a client, and the maximum number of leases for the client port has not been reached.	Adds or updates a lease entry in the DHCP snooping database.
	The maximum number of leases for the client port has been reached.	Drops the DHCP packet, generates a log message for the violation, generates an SNMP notification (trap), and does not add a lease entry to the database.
A lease entry in the DHCP snooping database expires		Removes the expired entry from the database.
Receives a DHCP BOOTP request packet on an untrusted port	The source MAC address and client hardware address match.	
Receives a DHCP BOOTP request packet on an untrusted port	The source MAC address and client hardware address do not match.	Drops the packet, generates a log message for the violation, and sends an SNMP notification (trap).
Receives a DHCP BOOTP request packet on an untrusted port	The packet contains Option 82 info.	Drops the DHCP packet, generates a log message for the violation, and sends an SNMP notification (trap).
Receives a DHCP BOOTP reply packet on an untrusted port		Drops the DHCP packet, generates a log message for the violation, and sends an SNMP notification (trap).
IP packets		
Receives an IP packet on a trusted port		Forwards the IP packet.
Receives an IP packet on an untrusted port	Its source MAC address, IP address, and receiving port match a valid lease entry in the DHCP snooping database.	Forwards the IP packet.
Receives an IP packet on an untrusted port	Its source MAC address, IP address, and receiving port do not match a valid lease entry in the DHCP snooping database.	Drops the packet. Does not generate a log message or an SNMP notification.
ARP packets		
Receives an ARP request on a trusted port		Forwards the ARP packet.
Receives an ARP request on an untrusted port	Its source MAC address, IP address, and receiving port match a valid entry in the DHCP snooping database	Forwards the ARP packet.
Receives an ARP request on an untrusted port	Its source MAC address, IP address, and receiving port do not match an entry in the DHCP snooping database	Drops the packet, generates a log message for the violation, and sends an SNMP notification (trap).

ARP Security

ARP security prevents ARP spoofing. ARP spoofing occurs when devices send fake, or 'spoofed', ARP messages to an Ethernet LAN. This makes it possible for an unauthorized host to claim to be an authorized host. The unauthorized host can then intercept traffic intended for the authorized host, and can access the wider network.

Spoofed ARP messages contain the IP address of an authorized host, with a MAC address which does not match the real MAC address of the host. When ARP security is enabled for DHCP snooping, the switch checks ARP packets sourced from untrusted ports against the entries in the DHCP snooping binding database. If it finds a matching entry, it forwards the ARP packet as normal. If it does not find a matching entry, it drops the ARP packet. This ensures that only trusted clients (with a recognized IP address and MAC address) can generate ARP packets into the network. ARP security is not applied to packets received on trusted ports.

ARP security is disabled by default, and can be enabled on VLANs to ensure that on untrusted ports, only trusted clients (with a recognized IP address and MAC address) can generate ARP packets into the network. ARP security is applied to both dynamic and static DHCP snooping entries. For static DHCP entries without a MAC address defined, ARP security compares only the IP address details.

MAC Address Verification

When MAC address verification is enabled, the switch forwards DHCP packets received on untrusted ports only if the source MAC address and client hardware address match. MAC address verification is enabled by default.

DHCP Snooping Violations

Packets violating DHCP snooping or ARP security checks (if these are enabled) are automatically dropped. The switch can also be configured to send SNMP notifications (atDhcpsnTrap and atArpsecTrap), to generate log messages, or to shut down the link on which the packet was received.

If the switch is configured to send notifications for DHCP snooping or ARP security violations, the rate is limited to one notification per second. If there are any further violations within a second, no notifications are sent for them. After one second, the switch only sends further notifications if the source MAC address and/or the violation reason are different from previous notifications. (If log messages are also generated for ARP security and DHCP snooping violations, you can see a record of all violations in the log, even if notifications were not sent for all of them.)

Interactions with Other Features

DHCP snooping interacts with other switch features as follows:

- **Ports in trunk mode**

The DHCP snooping feature is enabled or disabled per VLAN, and several of the related configuration settings are applied to ports. If there are multiple VLANs on a port, all the VLANs will be subject to the same per-port settings.
- **DHCP relay**

The switch cannot use DHCP snooping to filter IP traffic from a DHCP relay device. DHCP snooping ([service dhcp-snooping command on page 68.21](#)) and the DHCP relay agent option ([ip dhcp-relay agent-option command on page 76.13](#)) cannot both be enabled on the switch at the same time.
- **DHCP snooping can be configured with port provisioning.**
- **Authentication**

DHCP snooping cannot be enabled on a switch that is configured for web authentication ([auth-web enable command on page 57.27](#)), roaming authentication ([auth roaming enable command on page 57.16](#), [auth roaming disconnected command on page 57.14](#)), or guest VLAN authentication ([auth guest-vlan command on page 57.8](#)), or vice versa.
- **Stacking**

If DHCP snooping is enabled in a stack, the DHCP snooping database and its backup file are automatically synchronized across all stack members, so that a new stack master can reinstate this database.
- **Link aggregators**

DHCP snooping can operate over switch ports, and over static and dynamic (LACP) link aggregators (channel groups). If a switch port is added to an aggregator, DHCP snooping configuration is applied to the aggregator; configuration of the original switch port is not preserved. If the switch port is then removed from the aggregator, it returns to default DHCP snooping settings.
- **Private VLANs**

Private VLANs are not supported for DHCP snooping.

Configuration

This section provides a general configuration procedure for DHCP snooping.

Configure DHCP Snooping

Note that if a port in trunk mode has multiple VLANs attached, then the DHCP snooping configuration settings for the port apply to all the VLANs.

Table 67-2: General configuration procedure for DHCP snooping

Enable DHCP snooping		
1.	<code>awplus# configure terminal</code>	Enter Global Configuration mode.
2.	<code>awplus(config)# service dhcp-snooping</code>	Enable DHCP snooping on the switch. Default: disabled
3.	<code>awplus(config)# interface <vid-list></code>	Enter Interface Configuration mode for the VLANs to enable DHCP snooping on.
4.	<code>awplus(config-if)# ip dhcp snooping</code>	Enable DHCP snooping on these VLANs. Default: disabled
5.	<code>awplus(config-if)# exit</code>	Return to Global Configuration mode.
6.	<code>awplus(config-if)# interface <port-list></code>	Enter Interface Configuration mode for ports connected to the trusted network. The port(s) connected to the DHCP server(s) must be configured as trusted ports.
7.	<code>awplus(config-if)# ip dhcp snooping trust</code>	Set these ports to be trusted ports. Default: untrusted
8.	<code>awplus(config-if)# exit</code>	Return to Global Configuration mode.
9.	<code>awplus(config)# interface <port-list></code>	If you want to allow more than one DHCP lease for any ports, enter Interface Configuration mode for the required ports. The default value is likely to be suitable for edge ports; on an aggregation switch, you may need to increase the maximum number of leases for ports connected to other switches and/or for multiple VLANs. Note that you cannot change this setting once DHCP snooping ACLs are attached to these interfaces.
10.	<code>awplus(config-if)# ip dhcp snooping max-bindings <0-520></code>	Change the maximum number of leases for these ports. Default: 1
11.	<code>awplus(config-if)# exit</code>	Return to Global Configuration mode.

Table 67-2: General configuration procedure for DHCP snooping (cont.)

Configure DHCP filtering		
12.	<pre>awplus(config)# access-list hardware <name></pre>	Create a hardware access list, and enter Hardware Access List Configuration mode to configure it. See the access-list hardware (named) command on page 50.41 .
13.	<pre>awplus(config-ip-hw-acl)# [<seqnum>] permit ip dhcpsnooping any [<seqnum>] deny ip any any awplus(config-ip-hw-acl)# [<seqnum>] permit ip dhcpsnooping any mac dhcpsnooping any [<seqnum>] deny ip any any mac any any</pre>	Configure the hardware access list to permit traffic with <i>source IP address</i> matching valid entries in the DHCP snooping database, and to deny other traffic. (The last filter applied to the ports by any access list must be the filter that denies all other traffic.) OR Configure the hardware access list to permit traffic with <i>source IP address and source MAC address</i> matching valid entries in the DHCP snooping database, and to deny other traffic. (The last filter applied to the ports by any access list must be the filter that denies all other traffic.) See the access-list hardware IP protocol filter command on page 50.45 .
14.	<pre>awplus(config-ip-hw-acl)# exit</pre>	Return to Global Configuration mode.
15.	<pre>awplus(config)# interface <port-list></pre>	Enter Interface Configuration mode for the ports to add the DHCP snooping access list to. Typically this would be all untrusted ports.
16.	<pre>awplus(config-if)# access-group <name></pre>	Add the hardware-based access list(s) to these ports. The <i>name</i> in this command is the name of the access list specified in Step 12 .
17.	<pre>awplus(config-if)# exit</pre>	Return to Global Configuration mode.
Configure ARP security		
18.	<pre>awplus(config)# interface <vid-list></pre>	Enter Interface Configuration mode for the VLANs to enable ARP security on. Default: disabled
19.	<pre>awplus(config-if)# arp security</pre>	Enable ARP security on particular VLANs if required. On untrusted ports, ARP security forwards ARP packets that have a source IP address and MAC address matching a dynamic entry in the DHCP snooping database, or an IP address matching a static entry. It drops other ARP packets, and treats them as ARP security violations. Default: disabled
20.	<pre>awplus(config-if)# exit</pre>	Return to Global Configuration mode.

Table 67-2: General configuration procedure for DHCP snooping (cont.)

Configure DHCP Option 82		
21.	<pre>awplus(config)# no ip dhcp snooping agent-option</pre>	<p>If you do not want the switch to insert DHCP Option 82 information into DHCP packets received on untrusted ports, or to remove this information from DHCP packets transmitted on untrusted ports, disable the DHCP Option 82 agent option.</p> <p>Default: enabled if DHCP snooping is enabled.</p>
22.	<pre>awplus(config)# ip dhcp snooping agent-option allow- untrusted</pre>	<p>If there are edge switches that add the Option 82 information to DHCP packets, and that are connected to untrusted ports on this switch, you may wish to enable this switch to forward these packets, and the associated DHCP reply packets, without changing the Option 82 information in them.</p> <p>Default: disabled.</p>
23.	<pre>awplus(config)# interface <port-list></pre>	<p>Enter Interface Configuration mode for one or more ports to add a subscriber ID for.</p>
24.	<pre>awplus(config-if)# ip dhcp snooping subscriber-id [<sub- id>]</pre>	<p>Add the subscriber ID for these ports. The subscriber ID is included in Option 82 information.</p> <p>Default: no subscriber ID.</p>
25.	<pre>awplus(config-if)# exit</pre>	<p>Return to Global Configuration mode.</p>
Configure MAC address verification		
26.	<pre>awplus(config)# no ip dhcp snooping verify mac-address</pre>	<p>If not required, disable MAC address verification.</p> <p>Default: enabled</p>
Configure the DHCP snooping database		
27.	<pre>awplus(config)# ip dhcp snooping database {nvs flash card}</pre>	<p>If required, change the location of the file to which the switch writes the dynamic entries from the DHCP snooping database.</p> <p>Default: nvs (non-volatile storage)</p>
28.	<pre>awplus(config)# no ip dhcp snooping delete-by-client</pre>	<p>By default, the switch deletes DHCP lease entries from the DHCP snooping database when it receives matching DHCP release messages. Disable these deletions if required, so that lease entries remain in the database until they expire.</p> <p>Default: enabled—entries are deleted when leases are released.</p>
29.	<pre>awplus(config)# ip dhcp snooping delete-by-linkdown</pre>	<p>If required, set the switch to delete dynamic entries from the DHCP snooping database when their ports go down.</p> <p>Default: disabled—entries remain if links go down.</p>
30.	<pre>awplus(config)# ip source binding <ipaddr> [<macaddr>] vlan <vid> interface <port></pre>	<p>You can actively add, modify, or remove static entries from the DHCP snooping database.</p>

Table 67-2: General configuration procedure for DHCP snooping (cont.)

31.	<pre>awplus# ip dhcp snooping binding <ipaddr> [<macaddr>] vlan <vid> interface <port> expiry <expiry-time></pre>	You can actively add or remove dynamic entries from the DHCP snooping database. These changes affect the current database and backup file, but are not stored in the running configuration.
Configure violation actions		
32.	<pre>awplus(config)# interface <port-list></pre>	Enter Interface Configuration mode for the ports for which you want to configure actions in response to DHCP snooping or ARP security violations.
33.	<pre>awplus(config-if)# ip dhcp snooping violation {log trap link-down} ... arp security violation {log trap link-down} ...</pre>	If required, set the switch to generate an SNMP notification (trap), to generate a log message, and/or to block traffic on the port on which a DHCP snooping and/or ARP security violation is detected. Default: By default, if a packet does not match the DHCP snooping and ARP security restrictions, the packet is dropped, but no other action is taken.
34.	<pre>awplus(config-if)# exit</pre>	Return to Global Configuration mode.
35.	<pre>awplus(config)# snmp-server enable trap dhcpsnooping</pre>	<p>In order to send SNMP notifications:</p> <ul style="list-style-type: none"> ■ set the action for violations to trap (Step 33) ■ configure SNMP—see Chapter 78, SNMP Commands ■ set the SNMP server to enable DHCP snooping notifications (by default notifications are disabled on the SNMP server). <p>The port connecting the switch to the SNMP manager should be set as a trusted port (Step 7 on page 67.10).</p>
36.	<pre>awplus(config)# exit</pre>	Return to Privileged Exec mode.
Check the configuration		
37.	<pre>awplus# show ip dhcp snooping show ip dhcp snooping interface [<port-list>] show ip dhcp snooping acl show arp security show arp security interface [<port-list>] show running-config dhcp</pre>	Check the DHCP snooping configuration.
Troubleshooting DHCP snooping		
38.	<pre>awplus# show ip dhcp snooping binding</pre>	Check all entries in the DHCP snooping database.
39.	<pre>awplus# show ip source binding</pre>	Check the static entries in the DHCP snooping database.

Table 67-2: General configuration procedure for DHCP snooping (cont.)

40.	awplus#	Check DHCP snooping statistics.
	<pre>show ip dhcp snooping statistics [detail] [interface <interface-list>] clear ip dhcp snooping statistics [interface <port-list>]</pre>	
41.	awplus#	Check ARP security statistics.
	<pre>show arp security statistics [detail] [interface <port-list>] clear arp security statistics [interface <port-list>]</pre>	
42.	awplus#	Enable debug output for DHCP snooping and/or ARP security.
	<pre>debug ip dhcp snooping {all acl db packet [detail]} show debugging ip dhcp snooping debug arp security show debugging arp security</pre>	
43.		If you have not already set the switch to log DHCP snooping and ARP security violations, you can do this for troubleshooting purposes. See Step 33 on page 67.13 .
44.	awplus# show log	Display the contents of the buffered log, including any DHCP snooping log and debug messages. (See also Chapter 10, Logging Commands .)

Disabling DHCP Snooping

If you disable DHCP snooping on the whole switch ([no service dhcp-snooping command on page 68.21](#)), all the DHCP snooping configuration is removed, except for the Access Control Lists (ACL). Any ACLs on a port that permit traffic matching DHCP snooping entries and block other traffic, will block all traffic if DHCP snooping is disabled on the port. If you disable DHCP snooping either on the whole switch or on particular VLANs ([no ip dhcp snooping command on page 68.8](#)), you must also remove any DHCP snooping ACLs from the ports to maintain connectivity ([no access-group command on page 50.4](#)).

Related Features

In addition to configuring DHCP snooping as described in [Table 67-2](#), consider whether you also need to configure the following:

- VLANs—see [Chapter 16, VLAN Introduction](#) and [Chapter 17, VLAN Commands](#)
- Additional ACL filters—see [Chapter 49, Access Control Lists Introduction](#) and [Chapter 50, IPv4 Access Control List \(ACL\) Commands](#)
- QoS—see [Chapter 52, Quality of Service \(QoS\)](#) and [Chapter 53, QoS Commands](#)
- SNMP—[Chapter 77, SNMP Introduction](#) and [Chapter 78, SNMP Commands](#)

Chapter 68: DHCP Snooping Commands



Command List	68.2
arp security	68.2
arp security violation	68.3
clear arp security statistics	68.4
clear ip dhcp snooping binding	68.5
clear ip dhcp snooping statistics	68.6
debug arp security	68.6
debug ip dhcp snooping	68.7
ip dhcp snooping	68.8
ip dhcp snooping agent-option	68.9
ip dhcp snooping agent-option allow-untrusted	68.10
ip dhcp snooping binding	68.11
ip dhcp snooping database	68.12
ip dhcp snooping delete-by-client	68.13
ip dhcp snooping delete-by-linkdown	68.14
ip dhcp snooping max-bindings	68.15
ip dhcp snooping subscriber-id	68.16
ip dhcp snooping trust	68.17
ip dhcp snooping verify mac-address	68.18
ip dhcp snooping violation	68.19
ip source binding	68.20
service dhcp-snooping	68.21
show arp security	68.23
show arp security interface	68.24
show arp security statistics	68.25
show debugging arp security	68.27
show debugging ip dhcp snooping	68.27
show ip dhcp snooping	68.28
show ip dhcp snooping acl	68.29
show ip dhcp snooping binding	68.31
show ip dhcp snooping interface	68.32
show ip dhcp snooping statistics	68.34
show ip source binding	68.37

Command List

This chapter gives detailed information about the commands used to configure DHCP snooping. For detailed descriptions of related ACL commands, see [Chapter 50, IPv4 Access Control List \(ACL\) Commands](#). For more information about DHCP snooping, see [Chapter 67, DHCP Snooping Introduction](#).

DHCP snooping can operate on static link aggregators (e.g., sa2) and dynamic link aggregators (e.g. po3) link aggregators, as well as switch ports (e.g., port1.0.2).

arp security

Use this command to enable ARP security on untrusted ports in the VLANs, so that the switch only responds to/forwards ARP packets if they have recognized IP and MAC source addresses.

Use the **no** variant of this command to disable ARP security on the VLANs.

Syntax `arp security`
 `no arp security`

Default Disabled

Mode Interface Configuration (VLANs)

Usage Enable ARP security to provide protection against ARP spoofing. DHCP snooping must also be enabled on the switch ([service dhcp-snooping command on page 68.21](#)), and on the VLANs ([ip dhcp snooping command on page 68.8](#)).

Example To enable ARP security on VLANs 2 to 4, use the commands:

```
awplus# configure terminal
awplus(config)# interface vlan2-vlan4
awplus(config-if)# arp security
```

Related Commands [arp security violation](#)
 [show arp security](#)
 [show arp security interface](#)
 [show arp security statistics](#)

arp security violation

Use this command to specify an additional action to perform if an ARP security violation is detected on the ports. ARP security must also be enabled ([arp security command on page 68.2](#)).

Use the **no** variant of this command to remove the specified action, or all actions. Traffic violating ARP security will be dropped, but no other action will be taken.

Syntax `arp security violation {log|trap|link-down} ...`
`no arp security violation [log|trap|link-down] ...`

Parameter	Description
log	Generate a log message. To display these messages, use the show log command on page 10.40 .
trap	Generate an SNMP notification (trap). To send SNMP notifications, SNMP must also be configured, and DHCP snooping notifications must be enabled using the snmp-server enable trap command on page 78.16 . Notifications are limited to one per second and to one per source MAC and violation reason. Additional violations within a second of a notification being sent will not result in further notifications. Default: disabled.
link-down	Shut down the port that received the packet. Default: disabled.

Default When the switch detects an ARP security violation, it drops the packet. By default, it does not perform any other violation actions.

Mode Interface Configuration (switch ports, static or dynamic aggregated links)

Usage When the switch detects an ARP security violation on an untrusted port in a VLAN that has ARP security enabled, it drops the packet. This command sets the switch to perform additional actions in response to ARP violations.

If a port has been shut down in response to a violation, to bring it back up again after any issues have been resolved, use the [no shutdown command on page 12.12](#).

Example To send SNMP notifications for ARP security violations on ports 1.0.1 to 1.0.8, use the commands:

```
awplus# configure terminal
awplus(config)# snmp-server enable trap dhcpsnooping
awplus(config)# interface port1.0.1-port1.0.8
awplus(config-if)# arp security violation trap
```

Related Commands arp security
show arp security interface
show arp security statistics
show log
snmp-server enable trap

clear arp security statistics

Use this command to clear ARP security statistics for the specified ports, or for all ports.

Syntax clear arp security statistics [interface <port-list>]

Parameter	Description
<port-list>	The ports to clear statistics for. If no ports are specified, statistics are cleared for all ports. The ports may be switch ports, or static or dynamic link aggregators.

Mode Privileged Exec

Example To clear statistics for ARP security on interface port1.0.1, use the command:

```
awplus# clear arp security statistics interface port1.0.1
```

Related Commands arp security violation
show arp security
show arp security statistics

clear ip dhcp snooping binding

Use this command to remove one or more DHCP Snooping dynamic entries from the DHCP Snooping binding database. If no options are specified, all entries are removed from the database.

Caution  If you remove entries from the database for current clients, they will lose IP connectivity until they request and receive a new DHCP lease. If you clear all entries, all clients connected to untrusted ports will lose connectivity.

Syntax `clear ip dhcp snooping binding [<ipaddr>] [interface <port-list>]
[vlan <vid-list>]`

Parameter	Description
<ipaddr>	Remove the entry for this client IP address.
<port-list>	Remove all entries for these ports. The port list may contain switch ports, and static or dynamic link aggregators (channel groups).
<vid-list>	Remove all entries associated with these VLANs.

Mode Privileged Exec

Usage This command removes dynamic entries from the database. Note that dynamic entries can also be deleted by using the **no** variant of the [ip dhcp snooping binding command on page 68.11](#).

Dynamic entries can individually restored by using the [ip dhcp snooping binding](#) command.

To remove static entries, use the **no** variant of the [ip source binding command on page 68.20](#).

Example To remove a dynamic lease entry from the DHCP snooping database for a client with the IP address 192.168.1.2, use the command:

```
awplus# clear ip dhcp snooping binding 192.168.1.2
```

Related Commands [ip dhcp snooping binding](#)
[ip source binding](#)
[show ip dhcp snooping binding](#)

clear ip dhcp snooping statistics

Use this command to clear DHCP snooping statistics for the specified ports, or for all ports.

Syntax `clear ip dhcp snooping statistics [interface <port-list>]`

Parameter	Description
<port-list>	The ports to clear statistics for. If no ports are specified, statistics are cleared for all ports. The port list can contain switch ports, or static or dynamic link aggregators.

Mode Privileged Exec

Example To clear statistics for the DHCP snooping on interface port1.0.1, use the command:

```
awplus# clear ip dhcp snooping statistics interface port1.0.1
```

Related Commands `clear arp security statistics`
`show ip dhcp snooping`
`show ip dhcp snooping statistics`

debug arp security

Use this command to enable ARP security debugging.

Use the **no** variant of this command to disable debugging for ARP security.

Syntax `debug arp security`
`no debug arp security`

Default Disabled

Mode Privileged Exec

Example To enable ARP security debugging, use the commands:

```
awplus# debug arp security
```

Related Commands `show debugging arp security`
`show log`
`terminal monitor`

debug ip dhcp snooping

Use this command to enable the specified types of debugging for DHCP snooping.

Use the **no** variant of this command to disable the specified types of debugging.

Syntax `debug ip dhcp snooping {all|acl|db|packet [detail]}`
`no debug ip dhcp snooping {all|acl|db|packet [detail]}`

Parameter	Description
all	All DHCP snooping debug.
acl	DHCP snooping access list debug.
db	DHCP snooping binding database debug.
packet	DHCP snooping packet debug. For the no variant of this command, this option also disables detailed packet debug, if it was enabled.
detail	Detailed packet debug.

Default Disabled

Mode Privileged Exec

Example To enable access list debugging for DHCP snooping, use the commands:

```
awplus# debug ip dhcp snooping acl
```

Related Commands `debug arp security`
`show debugging ip dhcp snooping`
`show log`
`terminal monitor`

ip dhcp snooping

Use this command to enable DHCP snooping on one or more VLANs.

Use the **no** variant of this command to disable DHCP snooping on the VLANs.

Syntax `ip dhcp snooping`
`no ip dhcp snooping`

Default DHCP snooping is disabled on VLANs by default.

Mode Interface Configuration (VLANs)

Usage For DHCP snooping to operate on a VLAN, it must:

- be enabled on the particular VLAN by using this command
- be enabled globally on the switch by using the [service dhcp-snooping command on page 68.21](#)
- have at least one port connected to a DHCP server configured as a trusted port by using the [ip dhcp snooping trust command on page 68.17](#)

Any ACLs on a port that permit traffic matching DHCP snooping entries and block other traffic, will block all traffic if DHCP snooping is disabled on the port. If you disable DHCP snooping on particular VLANs using this command, you must also remove any DHCP snooping ACLs from the ports to maintain connectivity ([no access-group command on page 50.4](#)).

Example To enable DHCP snooping on VLANs 2 to 4, use the commands:

```
awplus# configure terminal
awplus(config)# interface vlan2-vlan4
awplus(config-if)# ip dhcp snooping
```

To disable DHCP snooping on the switch, use the command:

```
awplus# configure terminal
awplus(config)# interface vlan2-vlan4
awplus(config-if)# no ip dhcp snooping
```

Related Commands [ip dhcp snooping trust](#)
[service dhcp-snooping](#)
[show ip dhcp snooping](#)

ip dhcp snooping agent-option

Use this command to enable DHCP Option 82 data insertion on the switch. When this is enabled, the switch:

- inserts DHCP Option 82 into DHCP packets that it receives on untrusted ports
- removes DHCP Option 82 from DHCP packets that it sends to untrusted ports.

Use the **no** variant of this command to disable DHCP Option 82.

Syntax `ip dhcp snooping agent-option`
`no ip dhcp snooping agent-option`

Default DHCP Option 82 is enabled by default when DHCP snooping is enabled.

Mode Global Configuration

Usage DHCP snooping must also be enabled on the switch ([service dhcp-snooping command on page 68.21](#)), and on the VLANs ([ip dhcp snooping command on page 68.8](#)).

If a subscriber ID is configured for the port ([ip dhcp snooping subscriber-id command on page 68.16](#)), the switch includes this in the DHCP Option 82 information it inserts into DHCP packets received on the port.

Example To disable DHCP Option 82 on the switch, use the commands:

```
awplus# configure terminal
awplus(config)# no ip dhcp snooping agent-option
```

Related Commands [ip dhcp snooping](#)
[ip dhcp snooping agent-option allow-untrusted](#)
[ip dhcp snooping subscriber-id](#)
[service dhcp-snooping](#)
[show ip dhcp snooping](#)

ip dhcp snooping agent-option allow-untrusted

Use this command to enable DHCP Option 82 reception on untrusted ports. When this is enabled, the switch accepts incoming DHCP packets that contain DHCP option 82 data on untrusted ports.

Use the **no** variant of this command to disable DHCP Option 82 reception on untrusted ports.

Syntax `ip dhcp snooping agent-option allow-untrusted`
`no ip dhcp snooping agent-option allow-untrusted`

Default Disabled

Mode Global Configuration

Usage If the switch is connected via untrusted ports to edge switches that insert DHCP Option 82 data into DHCP packets, you may need to allow these DHCP packets through the untrusted ports, by using this command.

When this is disabled (default), the switch treats incoming DHCP packets on untrusted ports that contain DHCP option 82 data as DHCP snooping violations: it drops them and applies any violation action specified by the [ip dhcp snooping violation command on page 68.19](#). The switch stores statistics for packets dropped; to display these statistics, use the [show ip dhcp snooping statistics command on page 68.33](#).

Example To enable DHCP snooping Option 82 data reception on untrusted ports, use the commands:

```
awplus# configure terminal
awplus(config)# ip dhcp snooping agent-option allow-untrusted
```

Related Commands [ip dhcp snooping agent-option](#)
[ip dhcp snooping violation](#)
[show ip dhcp snooping](#)
[show ip dhcp snooping statistics](#)

ip dhcp snooping binding

Use this command to manually add a dynamic-like entry (with an expiry time) to the DHCP snooping database. Once added to the database, this entry is treated as a dynamic entry, and is stored in the DHCP snooping database backup file. This command is not stored in the switch's running configuration.

Use the **no** variant of this command to delete a dynamic entry for an IP address from the DHCP snooping database, or to delete all dynamic entries from the database.

Caution  If you remove entries from the database for current clients, they will lose IP connectivity until they request and receive a new DHCP lease. If you clear all entries, all clients connected to untrusted ports will lose connectivity.

Syntax

```
ip dhcp snooping binding <ipaddr> [<macaddr>] vlan <vid> interface
    <port> expiry <expiry-time>

no ip dhcp snooping binding [<ipaddr>]
```

Parameter	Description
<ipaddr>	Client's IP address.
<macaddr>	Client's MAC address in HHHH.HHHH.HHHH format.
<vid>	The VLAN ID for the entry, in the range 1 to 4094.
<port>	The port the client is connected to. The port can be a switch port, or a static or dynamic link aggregation (channel group).
<expiry-time>	The expiry time for the entry, in the range 5 to 2147483647 seconds.

Mode Privileged Exec

Usage Note that dynamic entries can also be deleted from the DHCP snooping database by using the [clear ip dhcp snooping binding command on page 68.5](#).

To add or remove static entries from the database, use the [ip source binding command on page 68.20](#).

Example To restore an entry in the DHCP snooping database for a DHCP client with the IP address 192.168.1.2, MAC address 0001.0002.0003, on port1.0.6 of vlan6, and with an expiry time of 1 hour, use the commands:

```
awplus# ip dhcp snooping binding 192.168.1.2 0001.0002.0003
      vlan 6 interface port1.0.6 expiry 3600
```

Related Commands

- [clear ip dhcp snooping binding](#)
- [ip source binding](#)
- [show ip dhcp snooping binding](#)

ip dhcp snooping database

Use this command to set the location of the file to which the dynamic entries in the DHCP snooping database are written. This file provides a backup for the DHCP snooping database.

Use the **no** variant of this command to set the database location back to the default, **nvs**.

Syntax `ip dhcp snooping database {nvs|flash|card}`
`no ip dhcp snooping database`

Parameter	Description
<code>nvs</code>	The switch checks the database and writes the file to non-volatile storage (NVS) on the switch at 2 second intervals if it has changed.
<code>flash</code>	The switch checks the database and writes the file to Flash memory on the switch at 60 second intervals if it has changed.
<code>card</code>	The switch checks the database and writes the file to an SD card installed in the switch at 2 second intervals if it has changed. Note that a current DHCP snooping backup database file is essential to maintain connectivity for DHCP clients after a switch reboot. If you configure the switch to save this file to an SD card, we recommend that you ensure the card is always present.

Default NVS

Mode Global Configuration

Usage In a stack, the backup file is automatically synchronized across all stack members to the location configured. If the backup file is stored on an SD card on the stack master, it is only synchronized across stack members that also have an SD card installed.

If the location of the backup file is changed by using this command, a new file is created in the new location, and the old version of the file remains in the old location. This can be removed if necessary (hidden file: `.dhcp.dsn.gz`).

Example To set the location of the DHCP snooping database to non-volatile storage on the switch, use the commands:

```
awplus# configure terminal
awplus(config)# ip dhcp snooping database nvs
```

Related Commands [show ip dhcp snooping](#)

ip dhcp snooping delete-by-client

Use this command to set the switch to remove a dynamic entry from the DHCP snooping database when it receives a valid DHCP release message with matching IP address, VLAN ID, and client hardware address on an untrusted port, and to discard release messages that do not match an entry in the database.

Use the **no** variant of this command to set the switch to forward DHCP release messages received on untrusted ports without removing any entries from the database.

Syntax `ip dhcp snooping delete-by-client`
`no ip dhcp snooping delete-by-client`

Default Enabled: by default, DHCP lease entries are deleted from the DHCP snooping database when matching DHCP release messages are received.

Mode Global Configuration

Usage DHCP clients send a release message when they no longer wish to use the IP address they have been allocated by a DHCP server. Use this command to enable DHCP snooping to use the information in these messages to remove entries from its database immediately. Use the **no** variant of this command to ignore these release messages. Lease entries corresponding to ignored DHCP release messages eventually time out when the lease expires.

Example To set the switch to delete DHCP snooping lease entries from the DHCP snooping database when a matching release message is received, use the commands:

```
awplus# configure terminal
awplus(config)# ip dhcp snooping delete-by-client
```

To set the switch to forward and ignore the content of any DHCP release messages it receives, use the commands:

```
awplus# configure terminal
awplus(config)# no ip dhcp snooping delete-by-client
```

Related Commands [show ip dhcp snooping](#)

ip dhcp snooping delete-by-linkdown

Use this command to set the switch to remove a dynamic entry from the DHCP snooping database when its port goes down. If the port is part of an aggregated link, the entries in the database are only deleted if all the ports in the aggregated link are down.

Use the **no** variant of this command to set the switch not to delete entries when ports go down.

Syntax `ip dhcp snooping delete-by-linkdown`
`no ip dhcp snooping delete-by-linkdown`

Default Disabled: by default DHCP Snooping bindings are not deleted when an interface goes down.

Mode Global Configuration

Usage If this command is enabled in a stack, and the master goes down and is replaced by a new master, entries in the DHCP snooping database for ports on the master are removed, unless they are part of link aggregators that are still up.

Examples To set the switch to delete DHCP snooping lease entries from the DHCP snooping database when links go down, use the commands:

```
awplus# configure terminal
awplus(config)# ip dhcp snooping delete-by-linkdown
```

To set the switch *not* to delete DHCP snooping lease entries from the DHCP snooping database when links go down, use the commands:

```
awplus# configure terminal
awplus(config)# no ip dhcp snooping delete-by-linkdown
```

Related Commands [show ip dhcp snooping](#)

ip dhcp snooping max-bindings

Use this command to set the maximum number of DHCP lease entries that can be stored in the DHCP snooping database for each of the ports. Once this limit has been reached, no further DHCP lease allocations made to devices on the port are stored in the database.

Use the **no** variant of this command to reset the maximum to the default, 1.

Syntax `ip dhcp snooping max-bindings <0-520>`

`no ip dhcp snooping max-bindings`

Parameter	Description
<code><0-520></code>	The maximum number of bindings that will be stored for the port in the DHCP snooping binding database. If 0 is specified, no entries will be stored in the database for the port.

Default The default value for maximum bindings is 1.

Mode Interface Configuration (port)

Usage The maximum number of leases cannot be changed for a port while there are DHCP snooping Access Control Lists (ACL) associated with the port. Before using this command, remove any DHCP snooping ACLs associated with the ports. To display ACLs used for DHCP snooping, use the [show ip dhcp snooping acl command on page 68.29](#).

In general, the default value (1) will work well on an edge port with a single directly connected DHCP client. If the port is on an aggregation switch that is connected to an edge switch with multiple DHCP clients connected through it, then use this command to increase the number of lease entries for the port.

If there are multiple VLANs configured on the port, the limit is shared between all the VLANs on this port. For example, the default value only allows one lease to be stored for one VLAN. To allow connectivity for the other VLANs, use this command to increase the number of lease entries for the port.

Example To set the maximum number of bindings to be stored in the DHCP snooping database to 10 per port for ports 1.0.1 to 1.0.8, use the commands:

```
awplus# configure terminal
awplus(config)# interface port1.0.1-port1.0.8
awplus(config-if)# ip dhcp snooping max-bindings 10
```

Related Commands [access-group](#)
[show ip dhcp snooping acl](#)
[show ip dhcp snooping interface](#)

ip dhcp snooping subscriber-id

Use this command to set a subscriber ID for the ports.

Use the **no** variant of this command to remove subscriber IDs from the ports.

Syntax `ip dhcp snooping subscriber-id [<sub-id>]`
`no ip dhcp snooping subscriber-id`

Parameter	Description
<sub-id>	The subscriber ID; an alphanumeric (ASCII) string 1 to 50 characters in length. If the subscriber ID contains spaces, it must be enclosed in double quotes. Wildcards are not allowed.

Default No subscriber ID.

Mode Interface Configuration (port)

Usage The subscriber-ID sub-option is included in the DHCP Option 82 field of client DHCP packets forwarded from a port if:

- a subscriber-ID is specified for the port using this command, and
- DHCP snooping Option 82 is enabled ([ip dhcp snooping agent-option command on page 68.9](#); enabled by default), and
- DHCP snooping is enabled on the switch ([service dhcp-snooping](#)) and on the VLAN to which the port belongs ([ip dhcp snooping](#))

Example To set the subscriber ID for port 1.0.3 to **room_534**, use the commands:

```
awplus# configure terminal
awplus(config)# interface port1.0.3
awplus(config-if)# ip dhcp snooping subscriber-id room_534
```

To remove the subscriber ID from port 1.0.3, use the commands:

```
awplus# configure terminal
awplus(config)# interface port1.0.3
awplus(config-if)# no ip dhcp snooping subscriber-id
```

Related Commands [ip dhcp snooping agent-option](#)
[show ip dhcp snooping interface](#)

ip dhcp snooping trust

Use this command to set the ports to be DHCP snooping trusted ports.

Use the **no** variant of this command to return the ports to their default as untrusted ports.

Syntax `ip dhcp snooping trust`
`no ip dhcp snooping trust`

Default All ports are untrusted by default.

Mode Interface Configuration (port)

Usage Typically, ports connecting the switch to trusted elements in the network (towards the core) are set as trusted ports, while ports connecting untrusted network elements are set as untrusted. Configure ports connected to DHCP servers as trusted ports.

Example To set switch ports 1.0.1 and 1.0.2 to be trusted ports, use the commands:

```
awplus# configure terminal
awplus(config)# interface port1.0.1-port1.0.2
awplus(config-if)# ip dhcp snooping trust
```

Related Commands [show ip dhcp snooping interface](#)

ip dhcp snooping verify mac-address

Use this command to verify that the source MAC address and client hardware address match in DHCP packets received on untrusted ports.

Use the **no** variant of this command to disable MAC address verification.

Syntax `ip dhcp snooping verify mac-address`
`no ip dhcp snooping verify mac-address`

Default Enabled—source MAC addresses are verified by default.

Mode Global Configuration

Usage When MAC address verification is enabled, the switch treats DHCP packets with source MAC address and client hardware address that do not match as DHCP snooping violations: it drops them and applies any other violation action specified by the [ip dhcp snooping violation command on page 68.19](#). To bring the port back up again after any issues have been resolved, use the [no shutdown command on page 12.12](#).

Example To disable MAC address verification on the switch, use the commands:

```
awplus# configure terminal
awplus(config)# no ip dhcp snooping verify mac-address
```

Related Commands [ip dhcp snooping violation](#)
[show ip dhcp snooping](#)
[show ip dhcp snooping statistics](#)

ip dhcp snooping violation

Use this command to specify the action the switch will take when it detects a DHCP snooping violation by a DHCP packet on the ports.

Use the **no** variant of this command to disable the specified violation actions, or all violation actions.

Syntax `ip dhcp snooping violation {log|trap|link-down} ...`
`no ip dhcp snooping violation [{log|trap|link-down} ...]`

Parameter	Description
log	Generate a log message. To display these messages, use the show log command on page 10.40 . Default: disabled.
trap	Generate an SNMP notification (trap). To send SNMP notifications, SNMP must also be configured, and DHCP snooping notifications must be enabled using the snmp-server enable trap command on page 78.16 . Notifications are limited to one per second and to one per source MAC and violation reason. Default: disabled.
link-down	Set the port status to link-down. Default: disabled.

Default By default, DHCP packets that violate DHCP snooping are dropped, but no other violation action is taken.

Mode Interface Configuration (port)

Usage If a port has been shut down in response to a violation, to bring it back up again after any issues have been resolved, use the [no shutdown command on page 12.12](#).

IP packets dropped by DHCP snooping filters do not result in other DHCP snooping violation actions.

Example To set the switch to send an SNMP notification and set the link status to link-down if it detects a DHCP snooping violation on switch ports 1.0.1 to 1.0.4, use the commands:

```
awplus# configure terminal
awplus(config)# snmp-server enable trap dhcpsnooping
awplus(config)# interface port1.0.1-port1.0.4
awplus(config-if)# ip dhcp snooping violation trap link-down
```

Related Commands [show ip dhcp snooping interface](#)
[show log](#)
[snmp-server enable trap](#)

ip source binding

Use this command to add or replace a static entry in the DHCP snooping database.

Use the **no** variant of this command to delete the specified static entry or all static entries from the database.

Syntax `ip source binding <ipaddr> [<macaddr>] vlan <vid> interface <port>`
`no ip source binding [<ipaddr>]`

Parameter	Description
<ipaddr>	Client's IP address. If there is already an entry in the DHCP snooping database for this IP address, then this command replaces it with the new entry.
<macaddr>	Client's MAC address in HHHH.HHHH.HHHH format.
<vid>	The VLAN ID associated with the entry.
<port>	The port the client is connected to.

Mode Global Configuration

Usage This command removes static entries from the database.

To remove dynamic entries, use the [clear ip dhcp snooping binding command on page 68.5](#) or the **no** variant of the [ip dhcp snooping binding command on page 68.11](#).

Example To add a static entry to the DHCP snooping database for a client with the IP address 192.168.1.2, MAC address 0001.0002.0003, on port1.0.6 of vlan6, use the command:

```
awplus# configure terminal
awplus(config)# ip source binding 192.168.1.2 0001.0002.0003
vlan 6 interface port1.0.6
```

To remove the static entry for IP address 192.168.1.2 from the database, use the commands:

```
awplus# configure terminal
awplus(config)# no ip source binding 192.168.1.2
```

To remove all static entries from the database, use the commands:

```
awplus# configure terminal
awplus(config)# no ip source binding
```

Related Commands [clear ip dhcp snooping binding](#)
[ip dhcp snooping binding](#)
[show ip dhcp snooping binding](#)
[show ip source binding](#)

service dhcp-snooping

Use this command to enable the DHCP snooping service globally on the switch. This must be enabled before other DHCP snooping configuration commands can be entered.

Use the **no** variant of this command to disable the DHCP snooping service on the switch. This removes all DHCP snooping configuration from the running configuration, except for any DHCP snooping maximum bindings settings ([ip dhcp snooping max-bindings command on page 68.15](#)), and any DHCP snooping-based Access Control Lists (ACLs), which are retained when the service is disabled.

Syntax `service dhcp-snooping`
`no service dhcp-snooping`

Default DHCP snooping is disabled on the switch by default.

Mode Global Configuration

Usage For DHCP snooping to operate on a VLAN, it must be enabled on the switch by using this command, and also enabled on the particular VLAN by using the [ip dhcp snooping command on page 68.8](#).

For DHCP snooping to operate on a VLAN, it must:

- be enabled globally on the switch by using this command
- be enabled on the particular VLAN by using the [ip dhcp snooping command on page 68.8](#)
- have at least one port connected to a DHCP server configured as a trusted port by using the [ip dhcp snooping trust command on page 68.17](#)

If you disable the DHCP snooping service by using the **no** variant of this command, all DHCP snooping configuration (including ARP security, but excluding maximum bindings and ACLs) is removed from the running configuration, and the DHCP snooping database is deleted from active memory. If you re-enable the service, the switch:

- repopulates the DHCP snooping database from the dynamic lease entries in the database backup file (in NVS by default—see the [ip dhcp snooping database command on page 68.12](#)). The lease expiry times are updated.

The DHCP snooping service cannot be enabled on a switch that is configured with any of the following features, or vice versa:

- web authentication ([auth-web enable command on page 57.27](#))
- roaming authentication ([auth roaming enable command on page 57.16](#), [auth roaming disconnected command on page 57.14](#))
- guest VLAN authentication ([auth guest-vlan command on page 57.8](#)).
- DHCP relay agent option ([ip dhcp-relay agent-option command on page 76.13](#))

Any ACLs on a port that permit traffic matching DHCP snooping entries and block other traffic, will block all traffic if DHCP snooping is disabled on the port. If you disable DHCP snooping on the switch using this command, you must also remove any DHCP snooping ACLs from the ports to maintain connectivity ([no access-group command on page 50.4](#)).

Example To enable DHCP snooping on the switch, use the command:

```
awplus# configure terminal
awplus(config)# service dhcp-snooping
```

To disable DHCP snooping on the switch, use the command:

```
awplus# configure terminal
awplus(config)# no service dhcp-snooping
```

Related Commands

- ip dhcp snooping
- ip dhcp snooping database
- ip dhcp snooping max-bindings
- show ip dhcp snooping

show arp security

Use this command to display ARP security configuration.

Syntax show arp security

Mode Privileged Exec

Example To display ARP security configuration on the switch use the command:

```
awplus# show arp security
```

Figure 68-1: Example output from the **show arp security** command

```
awplus# show arp security
ARP Security Information:
Total VLANs enabled ..... 2
Total VLANs disabled ..... 11
vlan1 ..... Disabled
vlan2 ..... Disabled
vlan3 ..... Disabled
vlan4 ..... Disabled
vlan5 ..... Disabled
vlan100 ..... Disabled
vlan101 ..... Disabled
vlan102 ..... Disabled
vlan103 ..... Disabled
vlan104 ..... Disabled
vlan105 ..... Enabled
vlan1000 ..... Disabled
vlan1001 ..... Enabled
```

Table 68-1: Parameters in the output from the **show arp security** command

Parameter	Description
Total VLANs enabled	The number of VLANs that have ARP security enabled.
Total VLANs disabled	The number of VLANs that have ARP security disabled.

Related Commands

- arp security
- show arp security interface
- show arp security statistics

show arp security interface

Use this command to display ARP security configuration for the specified ports or all ports.

Syntax `show arp security interface [<port-list>]`

Parameter	Description
<port-list>	The ports to display ARP security information about. The port list can include switch ports, and static or dynamic aggregated links.

Mode Privileged Exec

Example To display ARP security configuration for ports, use the command:

```
awplus# show arp security interface
```

Figure 68-2: Example output from the `show arp security interface` command

```
awplus#show arp security interface
Arp Security Port Status and Configuration:
  Port: Provisioned ports marked with brackets, e.g. (portx.y.z)
  KEY:  LG = Log
        TR = Trap
        LD = Link down

Port          Action
-----
port1.0.1    -- -- --
port1.0.2    -- -- --
port1.0.3    LG TR LD
port1.0.4    LG -- --
port1.0.5    LG -- --
port1.0.6    LG TR --
port1.0.7    LG -- LD
...
```

Table 68-2: Parameters in the output from the `show arp security interface` command

Parameter	Description
Action	The action the switch takes when it detects an ARP security violation on the port.
Port	The port. Parentheses indicate that ports are configured for provisioning.
LG, Log	Generate a log message
TR, Trap	Generate an SNMP notification (trap).
LD, Link down	Shut down the link.

Related Commands

- arp security violation
- show arp security
- show arp security statistics
- show log
- snmp-server enable trap

show arp security statistics

Use this command to display ARP security statistics for the specified ports or all ports.

Syntax `show arp security statistics [detail] [interface <port-list>]`

Parameter	Description
detail	Display detailed statistics.
interface <port-list>	Display statistics for the specified ports.

Mode Privileged Exec

Example To display the brief statistics for the ARP security, use the command:

```
awplus# show arp security statistics
```

Figure 68-3: Example output from the **show arp security statistics** command

```
awplus# show arp security statistics
DHCP Snooping ARP Security Statistics:
  Interface      In      In
  Interface      Packets Discards
-----
port1.0.3       20      20
port1.0.4       30      30
port1.0.12     120      0
```

Table 68-3: Parameters in the output from the **show arp security statistics** command

Parameter	Description
Interface	A port name. Parentheses indicate that ports are configured for provisioning.
In Packets	The total number of incoming APR packets that are processed by DHCP Snooping ARP Security
In Discards	The total number of ARP packets that are dropped by DHCP Snooping ARP Security.

Figure 68-4: Example output from the show arp security statistics detail command

```
awplus#show arp security statistics detail

DHCP Snooping ARP Security Statistics:

Interface ..... port1.0.3
  In Packets ..... 20
  In Discards ..... 20
  No Lease ..... 20
  Bad Vlan ..... 0
  Bad Port ..... 0
  Source Ip Not Allocated .... 0

Interface ..... port1.0.4
  In Packets ..... 30
  In Discards ..... 30
  No Lease ..... 30
  Bad Vlan ..... 0
  Bad Port ..... 0
  Source Ip Not Allocated .... 0

Interface ..... port1.0.12
  In Packets ..... 120
  In Discards ..... 0
  No Lease ..... 0
  Bad Vlan ..... 0
  Bad Port ..... 0
  Source Ip Not Allocated .... 0
```

Related Commands

- arp security
- arp security violation
- clear arp security statistics
- show arp security
- show arp security interface
- show log

show debugging arp security

Use this command to display the ARP security debugging configuration.

Syntax show debugging arp security

Mode Privileged Exec

Example To display the debugging settings for ARP security on the switch, use the command:

```
awplus# show debugging arp security
```

Figure 68-5: Example output from the **show debugging arp security** command

```
awplus# show debugging arp security
ARP Security debugging status:
  ARP Security debugging is off
```

Related Commands arp security violation
debug arp security

show debugging ip dhcp snooping

Use this command to display the DHCP snooping debugging configuration.

Syntax show debugging ip dhcp snooping

Mode Privileged Exec

Example To display the DHCP snooping debugging configuration, use the command:

```
awplus# show debugging ip dhcp snooping
```

Figure 68-6: Example output from the **show debugging ip dhcp snooping** command

```
awplus# show debugging ip dhcp snooping
DHCP snooping debugging status:
  DHCP snooping debugging is off
  DHCP snooping all debugging is off
  DHCP snooping acl debugging is off
  DHCP snooping binding DB debugging is off
  DHCP snooping packet debugging is off
  DHCP snooping detailed packet debugging is off
```

Related Commands debug ip dhcp snooping
show log

show ip dhcp snooping

Use this command to display DHCP snooping global configuration on the switch.

Syntax show ip dhcp snooping

Mode Privileged Exec

Example To display global DHCP snooping configuration on the switch, use the command:

```
awplus# show ip dhcp snooping
```

Figure 68-7: Example output from the **show ip dhcp snooping** command

```
awplus#show ip dhcp snooping
DHCP Snooping Information:
  DHCP Snooping service ..... Enabled
  Option 82 insertion ..... Enabled
  Option 82 on untrusted ports ..... Not allowed
  Binding delete by client ..... Disabled
  Binding delete by link down ..... Disabled
  Verify MAC address ..... Disabled
  SNMP DHCP Snooping trap ..... Disabled

DHCP Snooping database:
  Database location ..... nvs
  Number of entries in database ..... 2

DHCP Snooping VLANs:
  Total VLANs enabled ..... 1
  Total VLANs disabled ..... 9
  vlan1 ..... Enabled
  vlan2 ..... Disabled
  vlan3 ..... Disabled
  vlan4 ..... Disabled
  vlan5 ..... Disabled
  vlan100 ..... Disabled
  vlan101 ..... Disabled
  vlan105 ..... Disabled
  vlan1000 ..... Disabled
  vlan1001 ..... Disabled
```

Related Commands

- service dhcp-snooping
- show arp security
- show ip dhcp snooping acl
- show ip dhcp snooping binding
- show ip dhcp snooping interface

show ip dhcp snooping acl

Use this command to display information about the Access Control Lists (ACL) that are using the DHCP snooping database.

Syntax `show ip dhcp snooping acl`
`show ip dhcp snooping acl [detail|hardware] [interface`
 `[<interface-list>]]`

Parameter	Description
detail	Detailed DHCP Snooping ACL information.
hardware	DHCP Snooping hardware ACL information.
interface	ACL Interface information.
<interface-list>	The interfaces to display information about.

Mode Privileged Exec

Example To display DHCP snooping ACL information, use the command:

```
awplus# show ip dhcp snooping acl
```

Figure 68-8: Example output from the `show ip dhcp snooping acl` command

```
awplus#show ip dhcp snooping acl
DHCP Snooping Based Filters Summary:
```

Interface	Bindings	Maximum Bindings	Template Filters	Attached Hardware Filters
port1.0.1	1	520	0	0
port1.0.2	1	3	2	6
port1.0.3	1	2	4	8
port1.0.4	1	2	7	14
port1.0.5	0	2	6	12
port1.0.6	0	1	0	0
port1.0.7	0	1	0	0
port1.0.8	0	1	0	0
port1.0.9	0	1	0	0
port1.0.10	0	1	0	0
port1.0.11	0	1	0	0
port1.0.12	0	1	0	0
(port2.0.1)	0	520	0	0
(port2.0.2)	0	1	0	0

To display DHCP snooping hardware ACL information, use the command:

```
awplus# show ip dhcp snooping acl hardware
```

Figure 68-9: Example output from the `show ip dhcp snooping acl hardware` command

```
awplus#show ip dhcp snooping acl hardware

DHCP Snooping Based Filters in Hardware:
```

Interface	Access-list(/ClassMap)	Source IP	Source MAC
port1.0.2	dhcpsn1	10.10.10.10	aaaa.bbbb.cccc
port1.0.2	dhcpsn1	20.20.20.20	0000.aaaa.bbbb
port1.0.2	dhcpsn1	0.0.0.0	0000.0000.0000
port1.0.2	dhcpsn1	0.0.0.0	0000.0000.0000
port1.0.2	dhcpsn1	0.0.0.0	0000.0000.0000
port1.0.2	dhcpsn1	0.0.0.0	0000.0000.0000
port1.0.3	dhcpsn2/cmap1	30.30.30.30	aaaa.bbbb.dddd
port1.0.3	dhcpsn2/cmap1	40.40.40.40	0000.aaaa.cccc
port1.0.3	dhcpsn2/cmap1	50.50.50.50	0000.aaaa.dddd
port1.0.3	dhcpsn2/cmap1	60.60.60.60	0000.aaaa.eeee
port1.0.3	dhcpsn2/cmap1	0.0.0.0	0000.0000.0000
port1.0.3	dhcpsn2/cmap1	0.0.0.0	0000.0000.0000
port1.0.3	dhcpsn2/cmap1	0.0.0.0	0000.0000.0000
port1.0.3	dhcpsn2/cmap1	0.0.0.0	0000.0000.0000
port1.0.4	dhcpsn3/cmap2	70.70.70.70	
port1.0.4	dhcpsn3/cmap2	80.80.80.80	
port1.0.4	dhcpsn2/cmap1	70.70.70.70	
port1.0.4	dhcpsn2/cmap1	80.80.80.80	
port1.0.4	dhcpsn1	70.70.70.70	
port1.0.4	dhcpsn1	80.80.80.80	

To display detailed DHCP snooping ACL information for port 1.0.4, use the command:

```
awplus# show ip dhcp snooping acl detail interface port1.0.4
```

Figure 68-10: Example output from the `show ip dhcp snooping acl detail interface` command

```
awplus#show ip dhcp snooping acl detail interface port1.0.4

DHCP Snooping Based Filters Information:
```

port1.0.4	: Maximum Bindings 2
port1.0.4	: Template filters 7
port1.0.4	: Attached hardware filters	.. 14
port1.0.4	: Current bindings 1, 1 free
port1.0.4	: Client 1 120.120.120.120
port1.0.4	: Templates: cheese (via class-map: cmap2)	
port1.0.4	: 10 permit ip dhcp snooping	100.0.0.0/8
port1.0.4	: Template: dhcpsn2 (via class-map: cmap1)	
port1.0.4	: 10 permit ip dhcp snooping	any
port1.0.4	: 20 permit ip dhcp snooping	10.0.0.0/8
port1.0.4	: 30 permit ip dhcp snooping	20.0.0.0/8
port1.0.4	: 40 permit ip dhcp snooping	30.0.0.0/8
port1.0.4	: Template: dhcpsn1 (via access-group)	
port1.0.4	: 10 permit ip dhcp snooping	any mac dhcp snooping abcd.0000.0000 00 00.ffff.ffff
port1.0.4	: 20 permit ip dhcp snooping	any

Related Commands [access-list hardware \(named\)](#)
 [show access-list](#)

show ip dhcp snooping binding

Use this command to display all dynamic and static entries in the DHCP snooping binding database.

Syntax show ip dhcp snooping binding

Mode Privileged Exec

Example To display entries in the DHCP snooping database, use the command:

```
awplus# show ip dhcp snooping binding
```

Figure 68-11: Example output from the `show ip dhcp snooping binding` command

```
awplus# show ip dhcp snooping binding
DHCP Snooping Bindings:
```

Client IP Address	MAC Address	Server IP Address	VLAN	Port	Expires (sec)	Type
1.2.3.4	aaaa.bbbb.cccc	--	7	1.0.10	Infinite	Stat
1.2.3.6	any	--	4077	1.0.10	Infinite	Stat
1.3.4.5	any	--	1	sa1	Infinite	Stat
111.111.100.101	0000.0000.0001	111.112.1.1	1	1.0.10	4076	Dyna
111.111.101.108	0000.0000.0108	111.112.1.1	1	1.0.10	4084	Dyna
111.111.101.109	0000.0000.0109	111.112.1.1	1	1.0.10	4085	Dyna
111.211.100.101	--	--	1	1.0.2	2147483325	Dyna
111.211.100.109	00b0.0000.0009	111.112.111.111	1	1.0.2	21	Dyna
111.211.101.101	00b0.0000.0101	111.112.111.111	1	1.0.2	214	Dyna

Total number of bindings in database: 9

Table 68-4: Parameters in the output from the `show ip dhcp snooping binding` command

Parameter	Description
Client IP Address	The IP address of the DHCP client.
MAC Address	The MAC address of the DHCP client.
Server IP Address	The IP address of the DHCP server.
VLAN	The VLAN associated with this entry.
Port	The port the client is connected to.
Expires (sec)	The time in seconds until the lease expires.
Type	The source of the entry: <ul style="list-style-type: none"> ■ Dyna: dynamically entered by snooping DHCP traffic, configured by the <code>ip dhcp snooping binding</code> command, or loaded from the database backup file. ■ Stat: added statically by the <code>ip source binding</code> command
Total number of bindings in database	The total number of dynamic and static lease entries in the DHCP snooping database.

Related Commands

- [ip dhcp snooping binding](#)
- [ip dhcp snooping max-bindings](#)
- [show ip source binding](#)

show ip dhcp snooping interface

Use this command to display information about DHCP snooping configuration and leases for the specified ports, or all ports.

Syntax `show ip dhcp snooping interface [<port-list>]`

Parameter	Description
<port-list>	The ports to display DHCP snooping configuration information for. If no ports are specified, information for all ports is displayed.

Mode Privileged Exec

Example To display DHCP snooping information for all ports, use the command:

```
awplus# show ip dhcp snooping interface
```

Figure 68-12: Example output from the `show ip dhcp snooping interface` command

```
awplus#show ip dhcp snooping interface
DHCP Snooping Port Status and Configuration:
  Port: Provisioned ports marked with brackets, e.g. (portx.y.z)
  Action: LG = Log
          TR = Trap
          LD = Link down
```

Port	Status	Full Leases	Max Leases	Action	Subscriber-ID
port1.0.1	Untrusted	1	1	LG -- --	
port1.0.2	Untrusted	0	50	LG TR LD	Building 1 Level 1
port1.0.3	Untrusted	0	50	LG -- --	
port1.0.4	Untrusted	0	50	LG -- --	Building 1 Level 2
port1.0.5	Untrusted	0	50	LG -- LD	Building 2 Level 1
port1.0.6	Untrusted	0	1	LG -- --	
port1.0.7	Untrusted	0	1	LG -- --	
port1.0.8	Untrusted	0	1	LG -- --	
port1.0.9	Untrusted	0	1	-- TR --	
port1.0.10	Untrusted	0	1	-- -- LD	
port1.0.11	Trusted	0	1	-- -- --	
port1.0.12	Trusted	0	1	-- -- --	

Table 68-5: Parameters in the output from the `show ip dhcp snooping interface` command

Parameter	Description
Port	The port interface name.
Status	The port status: untrusted (default) or trusted.
Full Leases	The number of entries in the DHCP snooping database for the port.
Max Leases	The maximum number of entries that can be stored in the database for the port.
Action	The DHCP snooping violation actions for the port.

Table 68-5: Parameters in the output from the **show ip dhcp snooping interface** command (cont.)

Parameter	Description
Subscriber ID	The subscriber ID for the port. If the subscriber ID is longer than 34 characters, only the first 34 characters are displayed. To display the whole subscriber ID, use the show running-config dhcp command on page 7.35 .

Related Commands

- [show ip dhcp snooping](#)
- [show ip dhcp snooping statistics](#)
- [show running-config dhcp](#)

show ip dhcp snooping statistics

Use this command to display DHCP snooping statistics.

Syntax `show ip dhcp snooping statistics [detail] [interface <interface-list>]`

Parameter	Description
detail	Display detailed statistics.
interface <interface-list>	Display statistics for the specified interfaces. The interface list can contain switch ports, static or dynamic link aggregators (channel groups), or VLANs.

Mode Privileged Exec

Example To show the current DHCP snooping statistics for all interfaces, use the command:

```
awplus# show ip dhcp snooping statistics
```

 Figure 68-13: Example output from the **show ip dhcp snooping statistics** command

```
awplus# show ip dhcp snooping statistics
DHCP Snooping Statistics:
```

Interface	In Packets	In BOOTP Requests	In BOOTP Replies	In Discards
vlan1	444	386	58	223
port1.0.1	386	386	0	223
port1.0.2	0	0	0	0
port1.0.3	0	0	0	0
port1.0.4	0	0	0	0
port1.0.5	0	0	0	0
port1.0.6	0	0	0	0
port1.0.7	0	0	0	0
port1.0.8	0	0	0	0
port1.0.9	0	0	0	0
port1.0.10	0	0	0	0
port1.0.11	0	0	0	0
port1.0.12	58	0	58	0

Figure 68-14: Example output from the `show ip dhcp snooping statistics detail` command

```
awplus# show ip dhcp snooping statistics detail

DHCP Snooping Statistics:

Interface ..... port1.0.1, All counters 0
Interface ..... port1.0.2, All counters 0
Interface ..... port1.0.3, All counters 0
Interface ..... port1.0.4
  In Packets ..... 50
    In BOOTP Requests ..... 25
    In BOOTP Replies ..... 25
  In Discards ..... 1
    Invalid BOOTP Information ..... 0
    Invalid DHCP ACK ..... 0
    Invalid DHCP Release or Decline ..... 0
    Invalid IP/UDP Header ..... 0
    Max Bindings Exceeded ..... 1
    Option 82 Insert Error ..... 0
    Option 82 Received Invalid ..... 0
    Option 82 Received On Untrusted Port ..... 0
    Option 82 Transmit On Untrusted Port ..... 0
    Reply Received On Untrusted Port ..... 0
    Source MAC/CHADDR Mismatch ..... 0
    Static Entry Already Exists ..... 0
Interface ..... port1.0.5, All counters 0
Interface ..... port1.0.6, All counters 0
Interface ..... port1.0.7, All counters 0
Interface ..... port1.0.8, All counters 0
Interface ..... port1.0.9, All counters 0
Interface ..... port1.0.10, All counters 0
Interface ..... port1.0.11, All counters 0
Interface ..... port1.0.12, All counters 0
```

Table 68-6: Parameters in the output from the `show ip dhcp snooping statistics` command

Parameter	Description
Interface	The interface name.
In Packets	The total number of incoming packets that are processed by DHCP Snooping.
In BOOTP Requests	The total number of incoming BOOTP Requests.
In BOOTP Replies	The total number of incoming BOOTP Replies.
In Discards	The total number of incoming packets that have been discarded.
Invalid BOOTP Information	Packet contained invalid BOOTP information, such as an invalid BOOTP.OPCode.
Invalid DHCP ACK	A DHCP ACK message was discarded, for reasons such as missing Server Option or Lease Option.
Invalid DHCP Release or Decline	A DHCP Release or Decline message was discarded, for reasons such as mismatch between received interface and current binding information.
Invalid IP/UDP Header	A problem was detected in the IP or UDP header of the packet.
Max Bindings Exceeded	Accepting the packet would cause the maximum number of bindings on a port to be exceeded.
Option 82 Insert Error	An error occurred while trying to insert option 82 information.

Table 68-6: Parameters in the output from the **show ip dhcp snooping statistics** command (cont.)

Parameter	Description
Option 82 Received Invalid	The option 82 information received did not match the information inserted by DHCP Snooping.
Option 82 Received On Untrusted Port	A packet containing option 82 was received on an untrusted port.
Option 82 Transmit On Untrusted Port	A packet containing option 82 was to be sent on an untrusted port.
Reply Received On Untrusted Port	A BOOTP reply was received on an untrusted port.
Source MAC/CHADDR Mismatch	The L2 Source MAC address of the packet did not match the client hardware address field (BOOTP.CHADDR).
Static Entry Already Exists	An entry could not be added as a static entry already exists.

Related Commands [clear ip dhcp snooping statistics](#)
[ip dhcp snooping](#)
[ip dhcp snooping violation](#)

show ip source binding

Use this command to display static entries in the DHCP snooping database. These are the entries that have been added by using the [ip source binding command on page 68.20](#).

Syntax `show ip source binding`

Mode Privileged Exec

Example To display static entries in the DHCP snooping database information, use the command:

```
awplus# show ip source binding
```

Figure 68-15: Example output from the `show ip source binding` command

```
awplus# show ip source binding
IP Source Bindings:
Client      MAC
IP Address  Address      VLAN  Port          Expires
(sec)      Type
-----
1.1.1.1    0000.1111.2222  1    port1.0.1    Infinite  Static
```

Table 68-7: Parameters in the output from the `show ip source binding` command

Parameter	Description
Client IP Address	The IP address of the DHCP client.
MAC Address	The MAC address of the DHCP client.
VLAN	The VLAN ID the packet is received on.
Port	The Layer 2 port name the packet is received on.
Expires (sec)	Always infinite for static bindings, or when the leave time in the DHCP message was 0xffffffff (infinite).
Type	DHCP Snooping binding type: Static

Related Commands [ip source binding](#)
[show ip dhcp snooping binding](#)

Part 6: Network Availability



- Chapter 69 VRRP Introduction
- Chapter 70 VRRP Commands
- Chapter 71 EPSR Introduction
- Chapter 72 EPSR Commands

Chapter 69: VRRP Introduction



Introduction.....	69.2
Virtual Router Redundancy Protocol.....	69.3
VRRP Configuration.....	69.4
VRRP Election and Preempt.....	69.6
VRRP Authentication.....	69.7
VRRP Debugging.....	69.8
Configuration Examples.....	69.9

Introduction

This chapter describes the Virtual Router Redundancy Protocol (VRRP) feature provided by the switch, and how to configure the switch to participate in a virtual router.

One function of a switch is to act as a gateway to the WAN for hosts on a LAN. On larger LANs, two or more switches may act as the gateway, and hosts use a dynamic routing protocol, such as RIP or OSPF, to determine the gateway switch to use as the next hop in order to reach a specific IP destination. However, there are a number of factors, such as administrative or processing overhead, that may make it undesirable to use a dynamic routing protocol. One alternative is to use static routing; however, if the statically configured first hop switch fails, the hosts on the LAN are unable to communicate with those on the WAN.

The Virtual Router Redundancy Protocol defined in RFC 2338 provides a solution to the problem by combining two or more physical switches into a logical grouping called a **virtual router** (VR). The physical switches then operate together to provide a single logical gateway for hosts on the LAN.

Note If there are PIM-SM routers using VRRP the Bootstrap Router (BSR) function will not work properly.



Virtual Router Redundancy Protocol

The virtual router has a virtual MAC address that is known by all its participating switches or routers. The virtual MAC address is derived from the virtual router identifier - a user-defined value from 1 to 255. At the network level, all hosts on the LAN are configured with a common IP address that is used as the first hop. This IP address is typically owned by the virtual router's preferred individual switch or router. When available, this device performs the duties of the virtual router, and is referred to as the **master**. The switch that owns the IP address associated with the virtual router is referred to as the **preferred master**. When a virtual router is configured so that none of the participating switches owns the IP address, the virtual router has no preferred master.

When a switch takes the role of master for a virtual router, it is responsible for the following:

- Responding to ARP packets that contain IP addresses associated with the virtual router. The ARP response contains the virtual MAC address of the virtual router so that the hosts on the LAN associate the virtual MAC address with their configured first-hop IP address.
- Forwarding packets with a destination link layer MAC address equal to the virtual router MAC address.
- Accepting packets addressed to the IP addresses associated with the virtual router, but only if it actually owns the address(es).
- Broadcasting advertisement packets at regular intervals (at the specified advertisement interval) to inform backup switches that it is still acting as the master switch.

In accordance with the RFC standard, a user does not receive a response to ping or Telnet packets sent to the VR address unless the switch owns this address.

Each of the other switches participating in the virtual router is considered to be a backup switch. A switch can be part of several different virtual routers on one LAN, but all the virtual routers must have different virtual router identifiers (VRID). When a switch has the role of backup for a virtual router, it must be able to perform the following tasks:

- Receive advertisement packets from the master and check that the information contained in them is consistent with their own configuration; ignoring and discarding advertisement packets that do not match.
- Assume the role of master for the virtual router if an advertisement packet is not received for a given period, (the master-down time), based on the specified advertisement interval, (for example: `awplus(config-router)# advertisement-interval 5` will set the advertisement-interval to 5 seconds). The master-down time is approximately three times the advertisement interval.
- Assume the role of master if it receives an advertisement packet from another switch with a lower priority than its own, and if preempt mode is on.

If the master switch fails, the backup switch assumes control and starts processing traffic.

If a backup switch is about to assume the role of master of the VR because it has not received an advertisement for the master-down period, it first checks the operational status of the interface to which the VR is attached. If the interface is down, it does not enter the master state. Instead, it stays in the backup state and checks the interface again after another master-down period, assuming it does not receive an advertisement during that time.

VRRP Configuration

VRRP is disabled by default. Once you have defined a virtual router session, you must enable VRRP to make the session operational. You can then enable or disable the virtual router as shown:

To enable VRRP

```
awplus(config)#
router vrrp 1
```

Create a new VRRP session on the router and specify the virtual router ID (VRID) for the session.

```
awplus(config-router)#
enable
```

Enable the VRRP session on the switch.

```
awplus(config-router)#
exit
```

Return to the Global Configuration mode.

```
awplus(config)#
```

Global Configuration mode prompt.

To disable VRRP

```
awplus(config)#
router vrrp 1
```

Specify an existing VRRP session.

```
awplus(config-router)#
disable
```

Disable the VRRP session on the switch.

```
awplus(config-router)#
exit
```

Return to the Global Configuration mode.

```
awplus(config)#
```

Global Configuration mode prompt.

A virtual router must be defined on at least two switches before it operates correctly. Use the following steps to configure virtual routing on a switch. Note that this example assumes that VLAN 2 already exists on the switch. See [“Configuring VLANs” on page 16.3](#).

To configure virtual routing on a switch

```
awplus#
configure terminal
```

Enter the Global Configuration mode.

```
awplus(config)#
router vrrp 1
```

Create a new VRRP session on the router and specify the VRID for the session.

```
awplus(config-router)#
interface vlan2
```

Specify the interface (vlan2) that will participate in virtual routing.

```
awplus(config-router)#
virtual-ip 10.10.10.50 master
```

Set the virtual IP address for the VRRP session. Define the default state (master or backup) of the VRRP router within the virtual router.

To configure virtual routing on a switch (cont.)

```

awplus(config-router)#
    priority 255 Set the VRRP priority for the switch.
-----
awplus(config-router)#
    enable Enable the VRRP session on the switch.
-----
awplus(config-router)#
    exit Return to the Global Configuration mode.
-----
awplus(config)# Global Configuration mode prompt.

```

To destroy a virtual router on the LAN, it must be removed from all participating switches. Use the following commands to remove a virtual router so that the switch no longer participates in virtual routing.

To remove the virtual router VRRP 1 from a switch

```

awplus#
configure terminal Enter the Global Configuration mode.
-----
awplus(config)#
no router vrrp 1 Remove the VRRP session on the switch.
-----
awplus(config-router)#
exit Return to the Global Configuration mode.
-----
awplus(config)# Global Configuration mode prompt.

```

Alternatively, you can simply disable the virtual router and retain the configuration.

To disable the router and retain the configuration

```

awplus#
configure terminal Enter the Global Configuration mode.
-----
awplus(config)#
router vrrp 1 Select the VRRP session on the switch.
-----
awplus(config-router)#
disable Disable the VRRP session on the switch.
-----
awplus(config-router)#
exit Return to the Global Configuration mode.
-----
awplus(config)# Global Configuration prompt.

```

VRRP Election and Preempt

If the switch that is the current VRRP master becomes unavailable, the master role is taken by the switch with the next highest priority. The priority is a value from 1 to 255, with a default of 100. The value 255 is reserved for the switch that owns the virtual router's IP address. The new master takes over all the responsibilities of the original master.

By default, when a switch becomes available that has a higher priority than the master, this switch takes over as master. This is referred to as **preempt mode** and can be set **on** or **off**. Even with preempt mode **off**, the switch that owns the IP address always becomes the master when available. Preempt mode should be the same for all switches in the virtual router.

If two switches are configured with the same priority and a conflict occurs when they both transition to master simultaneously, the one with the highest IP address has higher priority. Due to timing differences the conflict may not always occur and simply the first switch to respond will become the master.

Hosts on the LAN can continue sending packets to the virtual MAC address they originally associated with the first hop IP address, even though the switch that owns the IP address is not currently available. When the original switch becomes available again, and if it is a preferred switch (i.e. it owns the virtual router IP address) then it resumes the role of master.

Use the following commands to set the priority and preempt mode when you create the virtual router:

To set the priority and preempt mode for VRRP 1

```

awplus#
  configure terminal  Enter the Global Configuration mode.
awplus(config)#
  router vrrp 1      Select the VRRP session on the switch.
awplus(config-router)#
  priority 255      Set the VRRP priority for the switch
awplus(config-router)#
  preempt true      Select the preempt mode for VRRP 1.
awplus(config-router)#
  enable            Enable the VRRP session on the switch.
awplus(config-router)#
  exit              Return to the Global Configuration mode.
awplus(config)#    Global Configuration prompt

```

The advertisement interval determines the rate that the master sends its advertisement packets. This rate must be the same value for all switches in the virtual router. The default advertisement interval of 1second can be used for most networks. However, you can modify this interval by using the **advertisement-interval** command, as shown in the following procedure:

To set the advertisement interval to 5 seconds on VRRP1

```

awplus#
configure terminal  Enter the Global Configuration mode.
awplus(config)#
router vrrp 1      Select the VRRP session on the switch.
awplus(config-router)#
advertisement-interval 5  Set the advertisement interval to 5 seconds.

```

VRRP Authentication

Each of the switches in the virtual router can be configured for plaintext authentication, or no authentication. Authentication is appropriate where there is either a security risk, or the configuration is complex.

Plaintext password authentication protects against accidental miscommunication and prevents a switch from inadvertently backing up another switch. This kind of miscommunication could occur, for example, where multiple virtual routers exist on the same LAN.

The authentication type and, in the case of plaintext authentication, the password, must be the same for all switches in the virtual router. By default, the virtual router has no authentication. Authentication must be defined against the relevant interface in the interface configuration mode as shown: This example assumes that VLAN 2 already exists on the switch. See [“Configuring VLANs” on page 16.3](#).

To set the authentication string “guest” to VLAN 2

```

awplus(config)#
interface v1an2  Specify the interface (v1an2) that will
                 participate in virtual routing.
awplus(config-if)#
ip vrrp authentication mode text  Apply text mode authentication to
                                   interface v1an2.
awplus(config-if)#
ip vrrp authentication string    Specify the authentication string or
                                   guest password used by the key.
Switch_A(config-if)#
exit  Exit the Interface Configuration mode and
      enter the Global Configuration mode.
awplus(config)#
exit  Return to the Privileged Exec mode
      prompt
awplus#  Privileged Exec mode prompt

```

In order to maintain consistent authentication level, each switch in the virtual router must have at least the minimum allowable level of security that meets the network environment.

VRRP Debugging

VRRP debugging displays data that is useful for troubleshooting. To enable or disable debugging use the following commands:

To select and deselect VRRP debugging

```
awplus#  
configure terminal Enter the Global Configuration mode.
```

```
awplus(config)#  
debug vrrp [all|events|packet] Enable the selected debugging type.
```

```
awplus(config)#  
no debug vrrp [all|events|packet] Disable the selected debugging type.
```

It is important that all switches involved in a virtual router are configured with the same values for the following:

- VRRP virtual router identifier
- IP address
- advertisement interval
- preempt mode
- authentication type
- password

Inconsistent configuration causes advertisement packets to be rejected and the virtual router cannot perform properly.

Configuration Examples

The following examples show how to configure a virtual router in a LAN:

- Preferred Master with Backup Switch
- Authenticated Virtual Router with No Preferred Master

Master with Backup Switch

This example show how to configure a basic virtual router with a preferred master and a backup.

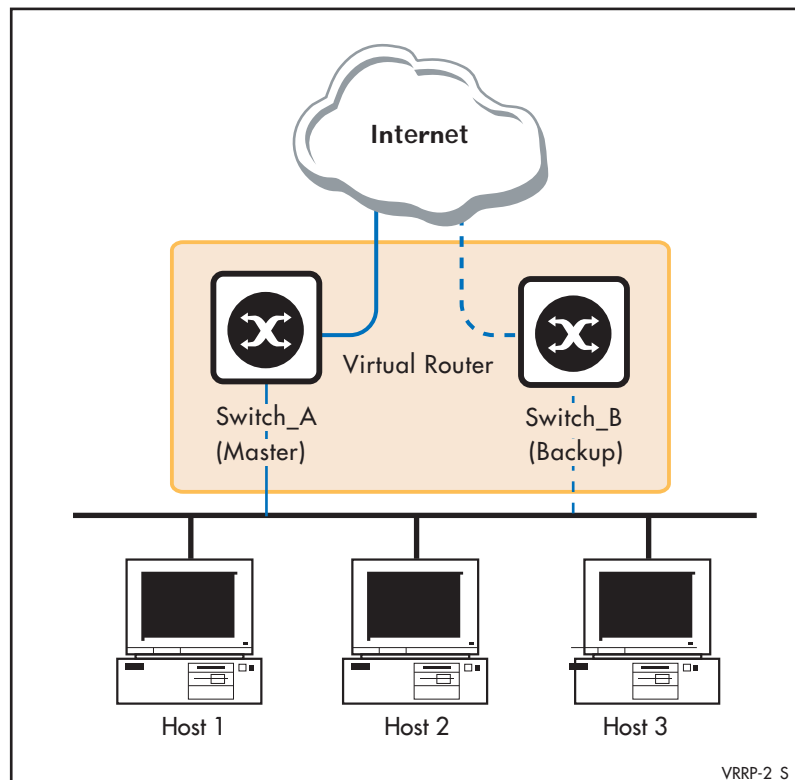

Switch_A owns the IP address of the virtual router, and always assumes the role of master whenever it is available. Switch_B is the backup, and assumes the role of master, backing up this IP address if A becomes unavailable. No authentication is used for this simple virtual router.

Step 1: Configure Switch_A

At this point we assume that you have already created VLAN 2 on Switch_A. See [“Configuring VLANs” on page 16.3](#).

Configure IP

```

awplus#
configure terminal Enter the Global Configuration mode.
-----
awplus(config)#
hostname Switch_A Assign a host name to Switch_A.
-----
Switch_A(config)#
interface vlan2 Specify the interface (vlan2) that will
participate in virtual routing.
-----
Switch_A(config-if)#
ip address 192.168.1.1/24 Specify the IP address and mask for interface
vlan2.

```

Create the Virtual Router

```

Switch_A(config)#
spanning-tree mode stp Configure STP for interfaces on Switch_A.
-----
Switch_A(config)#
router vrrp 1 Create a new VRRP session on the router
and specify the VRID for the session.
-----
Switch_A(config-router)#
interface vlan2 Specify the interface (vlan2) that will
participate in virtual routing.
-----
Switch_A(config-router)#
virtual-ip 192.168.1.1 master Set the virtual IP address for the VRRP
session. Define the default state of the VRRP
router within the virtual router.
-----
Switch_A(config-router)#
enable Enable the VRRP session on the router.
-----
Switch_A(config-router)#
exit Exit the Router Configuration mode and
enter the Global Configuration mode.
-----
Switch_A(config)#
exit Exit the Global Configuration mode and
enter the Privileged Exec mode.
-----
Switch_A# Privileged Exec mode prompt.

```

Step 2: Configure Switch_B

At this point we assume that you have already created VLAN 2 on Switch_B. See [“Configuring VLANs” on page 16.3](#).

Configure IP

```

awplus#
configure terminal  Enter Global Configuration mode.
awplus(config)#
hostname Switch_B  Assign a host name to Switch_B.
Switch_B(config)#
interface vlan2    Specify the interface (vlan2) that will participate
                  in virtual routing.
Switch_B(config)#
ip address 192.168.1.2/24  Specify the IP address and mask for interface

```

Create the Virtual Router

```

Switch_B(config)#
router vrrp 1      Create a new VRRP session on the router and
                  specify the VRID for the session.
Switch_B(config-router)#
interface vlan2    Specify the interface (vlan2) that will participate in
                  virtual routing.
Switch_B(config-router)#
virtual-ip 192.168.1.1  Set the virtual IP address for the VRRP session.
                    backup  Define the default state of the VRRP router within
                    the virtual router.
Switch_B(config-router)#
enable            Enable the VRRP session on the router.
Switch_B(config-router)
exit              Exit the Interface Configuration mode and enter the
                  Global Configuration mode.
Switch_B(config)#
exit              Return to the Privileged Exec mode.
Switch_B#        Privileged Exec mode prompt.

```

Authenticated Virtual Router with an Independent Preferred Master

This example shows how to configure a virtual router with its own IP address. The address is not owned by any of the switches participating in the virtual router. Switch A has a higher priority for becoming the master, Switch B has the next highest priority, and Switch C takes the master role when A or B are unavailable. The default preempt mode (preempt on) ensures that the switch with the highest priority (when it is available) always takes the master role from a lower priority switch acting as master. Plaintext authentication protects against accidental misconfiguration.

Although the switch with the highest priority will be master, it is important to remember that when creating VRRP you must also define the default role. In the following example Switch_A will be defined as being the master.

At this point we assume that you have already created VLAN 2 on Switches A, B and C. See [“Configuring VLANs” on page 16.3](#).

Step 1: Configure IP

On switch_A, add an IP interface to the virtual router.

```

awplus#
configure terminal  Enter Global Configuration mode.
awplus(config)#
hostname Switch_A  Assign a host name to Switch_A.
Switch_A(config)#
interface vlan2    Specify the interface (vlan2) that will participate in
                  virtual routing.
Switch_A(config)#
ip address 192.168.1.1/24  Add the IP address and mask for interface vlan2.

```

On switch_B, add a different IP interface to virtual router.

```

awplus#
configure terminal  Enter Global Configuration mode.
awplus(config)#
hostname Switch_B  Assign a host name to Switch_B.
Switch_B(config)#
interface vlan2    Specify the interface (vlan2) that will participate
                  in virtual routing.
Switch_B(config)#
ip address 192.168.1.2/24  Add the IP address and mask for interface vlan2.

```

On switch_C, add a third IP interface to the virtual router.

```

awplus#
configure terminal  Enter Global Configuration mode.
awplus(config)#
hostname Switch_C  Assign a host name to Switch_C.
Switch_C(config)#
interface vlan2    Specify the interface (vlan2) that will participate
                  in virtual routing.
Switch_C(config)#
ip address 192.168.1.3/24  Add the IP address and mask for interface vlan2.

```

Step 2: Create the virtual router

On switch A, create virtual router `vrrp2` with IP address `192.168.1.4`, plaintext authentication with password `trip4e`, and a high priority.

To configure the virtual router on switch_A

```

Switch_A#
configure terminal  Enter the Global Configuration mode.
Switch_A(config)#
router vrrp2       Create a new VRRP session on the router and
                  specify the VRID for the session.
Switch_A(config-router)#
interface vlan2    Specify the interface (vlan2) that will
                  participate in virtual routing.
Switch_A(config-router)#
virtual-ip 192.168.1.4 backup  Set the virtual IP address for the VRRP session.
                              Define the default state of the VRRP router
                              within the virtual router.
Switch_A(config-router)#
preempt-mode on    Turn on preempt mode.
Switch_A(config-router)#
priority 254       Set the VRRP priority of 254 for the switch.
Switch_A(config-router)#
enable            Enable VRRP on the switch.
Switch_A(config-router)#
exit              Return to the Global Configuration mode.
Switch_A(config)#
interface vlan2    Specify the interface (vlan2) that will
                  participate in virtual routing.
Switch_A(config-if)#
ip vrrp authentication mode  Apply text mode authentication to vlan2.
text

```

To configure the virtual router on switch_A

```
Switch_A(config-if)#
ip vrrp authentication string trip4e Specify the authentication string trip4e
trip4e used by the key.
Switch_A(config)#
exit Return to the Privileged Exec mode prompt.
Switch_A# Privileged Exec mode prompt.
```

On switch B, create the same virtual router, but with a lower priority.

To configure the virtual router on switch_B

```
Switch_B#
configure terminal Enter the Global Configuration mode.
Switch_B(config)#
router vrrp2 Create a new VRRP session on the router and
specify the VRID for the session.
Switch_B(config-router)#
interface vlan2 Specify the interface (vlan2) that will
participate in virtual routing.
Switch_B(config-router)#
virtual-ip 192.168.1.4 backup Set the virtual IP address for the VRRP
session. Define the default state of the VRRP
router within the virtual router.
Switch_B(config-router)#
preempt-mode on Turn on preempt mode.
Switch_B(config-router)#
priority 200 Set the VRRP priority of 200 for the switch.
Switch_B(config-router)#
enable Enable VRRP on the switch.
Switch_A(config-router)#
exit Return to the Global Configuration mode.
Switch_B(config)#
interface vlan2 Specify the interface (vlan2) that will
participate in virtual routing.
```

To configure the virtual router on switch_B

```

Switch_B(config-if)#
ip vrrp authentication mode text Apply text mode authentication to v1an2.

```

```

Switch_B(config-if)#
ip vrrp authentication string trip4e Specify the authentication string trip4e
                                trip4e used by the key.

```

```

Switch_B(config-if)#
exit Return to the Global Configuration mode.

```

```

Switch_B(config)#
exit Return to the Privileged Exec mode prompt.

```

```

Switch_B# Privileged Exec mode prompt.

```

On switch C, create the same virtual router with the default priority of 100.

To configure the virtual router on switch_C

Switch_C#	
<code>configure terminal</code>	Enter the Global Configuration mode.
Switch_C(config)#	
<code>router vrrp2</code>	Create a new VRRP session on the router and specify the VRID for the session.
Switch_C(config-router)#	
<code>interface vlan2</code>	Specify the interface (vlan2) that will participate in virtual routing.
Switch_C(config-router)#	
<code>virtual-ip 192.168.1.4 backup</code>	Set the virtual IP address for the VRRP session. Define the default state (master or backup) of the VRRP router within the virtual router.
Switch_C(config-router)#	
<code>preempt-mode on</code>	Turn on preempt mode.
Switch_C(config-router)#	
<code>priority 100</code>	Set the VRRP priority of 100 for the switch.
Switch_C(config-router)#	
<code>enable</code>	Enable VRRP on the switch.
Switch_A(config-router)#	
<code>exit</code>	Return to the Global Configuration mode.
Switch_C(config)#	
<code>interface vlan2</code>	Specify the interface (vlan2) that will participate in virtual routing.
Switch_C(config-if)#	
<code>ip vrrp authentication mode text</code>	Apply text mode authentication to vlan2.
Switch_C(config-if)#	
<code>ip vrrp authentication string trip4e</code>	Specify the authentication string trip4e used by the key.
Switch_B(config-if)#	
<code>exit</code>	Return to the Global Configuration mode.
Switch_C(config)#	
<code>exit</code>	Return to the Privileged Exec mode prompt
Switch_C#	Privileged Exec mode prompt

The default preempt mode ensures that the highest priority switch available always takes the master role. However, if there are no significant disadvantages to the lower priority switches having the master role, and if changes where the switch takes the master role are to be avoided (for example, when a high cost is associated with each change) then you should instead set the preempt mode to **off**.

Chapter 70: VRRP Commands



Command List	70.2
advertisement-interval	70.2
circuit-failover	70.3
debug vrrp	70.4
debug vrrp events	70.4
debug vrrp packet	70.5
disable (VRRP)	70.5
enable (VRRP)	70.6
interface (VRRP)	70.6
ip vrrp authentication mode	70.7
ip vrrp authentication string	70.8
preempt-mode	70.9
priority	70.10
router vrrp	70.11
show debugging vrrp	70.11
show running-config router vrrp	70.12
show vrrp	70.12
show vrrp (session)	70.13
undebg vrrp	70.14
undebg vrrp events	70.14
undebg vrrp packet	70.14
virtual-ip	70.15
vrrp vmac	70.15

Command List

This chapter provides an alphabetical reference for commands used to configure the Virtual Router Redundancy Protocol (VRRP). For more information, see [Chapter 69, VRRP Introduction](#).

For information about modifying or redirecting the output from **show** commands to a file, see [“Controlling “show” Command Output” on page 1.35](#).

advertisement-interval

Use this command to configure the advertisement interval of the virtual router. This is the length of time, in seconds, between each advertisement sent from the master to its backup(s).

Use the **no** variant of this command to remove an advertisement interval of the virtual router, which has been set using the **advertisement-interval** command.

Syntax advertisement-interval <1-255>
no advertisement-interval

Parameter	Description
<1-255>	Specifies the advertisement interval in seconds.

Default The default advertisement interval is 1 second.

Mode Router Configuration

Example

```
awplus# configure terminal
awplus(config)# router vrrp 5
awplus(config-router)# interface vlan2
awplus(config-router)# advertisement-interval 6

awplus# configure terminal
awplus(config)# router vrrp 5
awplus(config-router)# interface vlan2
awplus(config-router)# no advertisement-interval
```

circuit-failover

Use this command to enable the VRRP circuit failover feature.

Use the **no** variant of this command to disable this feature.

Syntax `circuit-failover <interface> <1-253>`
`no circuit-failover [<interface> <1-253>]`

Parameter	Description
<code><interface></code>	The interface of the router that will participate in the virtual router. Interface must exist on the router.
<code><1-253></code>	Delta value. The value by which virtual routers decrement their priority value during a circuit failover event. Configure this value to be greater than the difference of priorities on the master and backup routers.

Mode Router Configuration

Example

```
awplus# configure terminal
awplus(config)# router vrrp 1
awplus(config-router)# interface vlan1
awplus(config-router)# circuit-failover vlan2 30

awplus# configure terminal
awplus(config)# router vrrp 1
awplus(config-router)# interface vlan1
awplus(config-router)# no circuit-failover
```

Related Commands `router vrrp`

debug vrrp

Use this command to specify debugging options for VRRP. The `all` parameter turns on all the debugging options.

Use the `no` variant of this command to disable this function.

Syntax `debug vrrp [all]`
`no debug vrrp [all]`

Mode Privileged Exec and Global Configuration

Examples

```
awplus# configure terminal
awplus(config)# debug vrrp all

awplus# configure terminal
awplus(config)# no debug vrrp
```

Related Commands [undebug vrrp](#)

debug vrrp events

Use this command to specify debugging options for VRRP event troubleshooting.

Use the `no` variant of this command to disable this function.

Syntax `debug vrrp events`
`no debug vrrp events`

Mode Privileged Exec and Global Configuration

Usage The `debug vrrp events` command enables the display of debug information related to VRRP internal events.

Examples

```
awplus# configure terminal
awplus(config)# debug vrrp events

awplus# configure terminal
awplus(config)# no debug vrrp events
```

Related Commands [undebug vrrp events](#)

debug vrrp packet

Use this command to specify debugging options for VRRP packets.

Use the **no** variant of this command to disable this function.

Syntax `debug vrrp packet [send|recv]`
`no debug vrrp packet [send|recv]`

Parameter	Description
send	Specifies the debug option set for sent packets.
recv	Specifies the debug option set for received packets.

Mode Privileged Exec and Global Configuration

Usage The `debug vrrp packet` command enables the display of debug information related to the sending and receiving of packets.

Examples

```
awplus# configure terminal
awplus(config)# debug vrrp packet send

awplus# configure terminal
awplus(config)# no debug vrrp packet
```

Related Commands [undebug vrrp packet](#)

disable (VRRP)

Use this command to disable a VRRP session on the router to stop it participating in virtual routing.

Syntax `disable`

Mode Router Configuration

Example

```
awplus# configure terminal
awplus(config)# router vrrp 5
awplus(config-router)# interface vlan2
awplus(config-router)# disable
```

Related Commands [enable \(VRRP\)](#)

enable (VRRP)

Use this command to enable the VRRP session on the router to make it participate in virtual routing.

Syntax `enable`

Mode Router Configuration

Usage You must configure the virtual IP address and define the interface for the VRRP session (using the `virtual-ip` and `interface` commands) before using this command.

Example

```
awplus# configure terminal
awplus(config)# router vrrp 5
awplus(config-router)# interface vlan2
awplus(config-router)# enable
```

Related Commands [disable \(VRRP\)](#)

interface (VRRP)

Use this command define the physical interface that will participate in virtual routing. This interface is used for two purposes - to send/receive advertisement messages and to forward on behalf of the virtual router when in master state. Note that you can also specify the interface within the `circuit-failover` and the `router vrrp` commands without specifying the interface later.

Syntax `interface <interface>`

Parameter	Description
<code><interface></code>	Specify the name of the interface that will participate in the virtual routing. Interface must exist on the router.

Mode Router Configuration

Usage Use the `no` variant of this command to remove the specified interface from participating in virtual routing.

Example To configure an interface on which VRRP is enabled enter the commands shown below:

```
awplus# configure terminal
awplus(config)# router vrrp 5
awplus(config-router)# interface vlan2
```

Related Commands [router vrrp](#)

ip vrrp authentication mode

Use this command to enable clear text password authentication used for VRRP packets.

Use the [ip vrrp authentication string](#) command after this command to specify the password.

Use the **no** variant of this command to reset to the default of no text authentication.

Syntax `ip vrrp authentication mode text`
`no ip vrrp authentication mode [text]`

Parameter	Description
text	Specifies the clear text or simple password authentication.

Default No text authentication.

Mode Interface Configuration for a VLAN interface.

Usage RFC 3768 *Virtual Router Redundancy Protocol (VRRP)* recommends no authentication. VRRP authentication commands are available for backwards compatibility the earlier VRRP RFC 2338. See "[VRRP Authentication](#)" on page 69.7 for further information about VRRP Authentication.

Examples The following example shows text authentication configured on the `vlan2` interface ensuring authentication packets received on this interface.

```
awplus# configure terminal
awplus(config)# interface vlan2
awplus(config-if)# ip vrrp authentication mode text
```

The following example resets to the default setting for no text authentication on `vlan2`.

```
awplus# configure terminal
awplus(config)# interface vlan2
awplus(config-if)# no ip vrrp authentication mode
```

Related Commands [ip vrrp authentication string](#)

ip vrrp authentication string

Use this command to specify the authentication string or password used by a key.

Use this command after [ip vrrp authentication mode](#) that enables clear text authentication.

Use the **no** variant of this command to remove a configured authentication string.

Syntax `ip vrrp authentication string <password>`
`no ip vrrp authentication string`

Parameter	Description
<code><password></code>	The authentication string or password.

Mode Interface Configuration for a VLAN interface.

Example In the following example, the interface `vlan2` is configured to have an authentication string as `guest`, any receiving packet in that interface should have the same string as password.

```
awplus# configure terminal
awplus(config)# interface vlan2
awplus(config-if)# ip vrrp authentication mode text
awplus(config-if)# ip vrrp authentication string guest
```

See [“VRRP Authentication” on page 69.7](#) for further information about VRRP Authentication.

Related Commands [ip vrrp authentication mode](#)

preempt-mode

Use this command to configure preempt mode. If set to true, the highest priority backup will always be the master when the default master is unavailable. If set to false, a higher priority backup will not preempt a lower priority backup who is acting as master.

Syntax `preempt-mode {true|false}`

Parameter	Description
<code>true</code>	Preemption enabled.
<code>false</code>	Preemption disabled.

Default The default is true.

Mode Router Configuration

Usage When the master router fails, the backup routers come online in priority order—highest to lowest. Preempt mode means that a higher priority back up router will take over the master role from a lower priority back up. Preempt mode on **true** allows a higher priority backup router to relieve a lower priority backup router.

See “[VRRP Election and Preempt](#)” on page 69.6 for further information on preempt mode.

Example

```
awplus# configure terminal
awplus(config)# router vrrp 4
awplus(config-router)# interface vlan2
awplus(config-router)# preempt-mode false
```

Related Commands [circuit-failover](#)
[priority](#)

priority

Use this command to configure the VRRP router priority within the virtual router. The highest priority router is Master (unless **preempt-mode** is false).

Use the **no** variant of this command to remove the VRRP router priority within the virtual router, which has been set using the **priority** command.

Syntax `priority <1-255>`
`no priority`

Parameter	Description
<code><1-255></code>	The priority. For the master router, use 255 for this parameter; otherwise use any number from the range <code><1-254></code> .

Default Default values for priority are: **master router** = 255; **backup** = 100.

Mode Router Configuration

Example

```
awplus# configure terminal
awplus(config)# router vrrp 3
awplus(config-router)# interface vlan2
awplus(config-router)# priority 101
```

Related Commands `circuit-failover`
`preempt-mode`

router vrrp

Use this command to configure VRRP. This command allows you to enter the Router Configuration mode.

Use the **no** variant of this command to remove the VRRP configuration. Disable the VRRP session before using the **no** variant of this command.

Syntax `router vrrp <vrid> [<interface>]`
`no router vrrp <vrid> [<interface>]`

Parameter	Description
<vrid>	<1-255> The ID of the virtual router session to create.
<interface>	Specify the name of the interface that will participate in the virtual routing. The interface must exist on the router.

Mode Global Configuration

Example

```
awplus# configure terminal
awplus(config)# router vrrp 5 vlan2
awplus(config-router)#

awplus# configure terminal
awplus(config)# router vrrp 5
awplus(config-router)# interface vlan2
awplus(config-router)#
```

Related Commands [circuit-failover](#)
[interface \(VRRP\)](#)

show debugging vrrp

Use this command to display the set VRRP debugging option.

For information on output options, see ["Controlling "show" Command Output" on page 1.35.](#)

Syntax `show debugging vrrp`

Mode Privileged Exec

Example

```
awplus# show debugging vrrp
```

show running-config router vrrp

Use this command to show the configuration for VRRP.

- This command is available only if VRRP is enabled.

For information on output options, see [“Controlling “show” Command Output” on page 1.35.](#)

Syntax show running-config router vrrp

Mode Privileged Exec, Global Configuration, Line Configuration, and Interface Configuration.

Example

```
awplus# show running-config router vrrp
```

Output Figure 70-1: Example output from the **show running-config router vrrp** command

```
!  
router vrrp 2 vlan2  
  circuit-failover vlan1 3  
  advertisement-interval 4  
!
```

show vrrp

Use this command to display information about all VRRP sessions.

For information on output options, see [“Controlling “show” Command Output” on page 1.35.](#)

Syntax show vrrp

Mode User Exec and Privileged Exec

Example

```
awplus# show vrrp
```

Output Figure 70-2: Example output from the **show vrrp** command

```
awplus#show vrrp  
VrID <1>  
  State is Master  
  Virtual IP is 10.0.0.222 (Not IP owner)  
  Interface is vlan2  
  Priority is 100  
  Advertisement interval is 1 sec  
  Preempt mode is TRUE
```

show vrrp (session)

Use this command to display information for a particular VRRP session.

For information on output options, see [“Controlling “show” Command Output” on page 1.35.](#)

Syntax `show vrrp <vrid> <interface>`

Parameter	Description
<code><vrid></code>	<code><1-255></code> The virtual router ID for which to display information. Session must already exist.
<code><interface></code>	The interface to display information about, for instance, <code>vlan2</code> .

Mode User Exec and Privileged Exec

Usage See the below sample output from the `show vrrp` command displaying information about VRRP session 1 configured on `vlan2`. Output shows that a Virtual IP address has been set.

```
awplus# show vrrp 1 vlan2
```

```
awplus#show vrrp 1 vlan2
Address family IPv4
VrId <1>
Interface is vlan2
State is Initialize
Virtual IP address is 10.10.11.250 (Not IP owner)
Priority is 100
Advertisement interval is 1 sec
Preempt mode is TRUE
```

See the below sample output from the `show vrrp` command displaying information about VRRP session 1 configured on `vlan3`. Output shows a Virtual IP address has not been set yet.

```
awplus# show vrrp 1 vlan3
```

```
awplus#show vrrp 1 vlan3
Address family IPv4
VrId <1>
Interface is vlan3
State is Initialize
Virtual IP address is unset
Priority is 100
Advertisement interval is 1 sec
Preempt mode is TRUE
```

Example The following command shows information about VRRP session 5 for interface `vlan2`.

```
awplus# show vrrp 5 vlan2
```

undebug vrrp

Use this command to disable all VRRP debugging.

Syntax `undebug vrrp all`

Mode Privileged Exec

Example

```
awplus# undebug vrrp all
```

Related Commands [debug vrrp](#)

undebug vrrp events

Use this command to disable debugging options for VRRP event troubleshooting.

Syntax `undebug vrrp events`

Mode Privileged Exec

Example

```
awplus# undebug vrrp events
```

Related Commands [debug vrrp events](#)

undebug vrrp packet

Use this command to disable debugging options for VRRP packets.

Syntax `undebug vrrp packet [send|recv]`

Parameter	Description
<code>send</code>	Disable the debug option set for sent packets.
<code>recv</code>	Disable the debug option set for received packets.

Mode Privileged Exec

Example

```
awplus# undebug vrrp packet send
```

Related Commands [debug vrrp packet](#)

virtual-ip

Use this command to set the virtual IP address for the VRRP session. This is the IP address of the virtual router that end hosts set as their default gateway.

Use the **no** variant of this command to disable this feature.

Syntax `virtual-ip <ip-address> master`
`virtual-ip <ip-address> backup`
`no virtual-ip`

Parameter	Description
<code><ip-address></code>	The virtual IP address of the virtual router, entered in the format A.B.C.D.
<code>master</code>	Sets the default state of the VRRP router within the Virtual Router as master . For master, the router must own the Virtual IP address.
<code>backup</code>	Sets the default state of the VRRP router within the Virtual Router as backup .

Mode Router Configuration

Example

```
awplus# configure terminal
awplus(config)# router vrrp 5
awplus(config-router)# interface vlan2
awplus(config-router)# virtual-ip 192.0.2.30 master
```

vrrp vmac

Use this command to enable or disable the Virtual MAC feature.

Syntax `vrrp vmac {enable|disable}`

Mode Global Configuration

Example To enable Virtual MAC enter:

```
awplus# configure terminal
awplus(config)# vrrp vmac enable
```

To disable Virtual MAC enter:

```
awplus# configure terminal
awplus(config)# vrrp vmac disable
```

Chapter 71: EPSR Introduction



Introduction.....	71.2
Ring Components and Operation	71.2
Fault Detection and Recovery.....	71.4
Fault Recovery.....	71.4
Restoring Normal Operation.....	71.6
Managing Rings with Two Breaks.....	71.7
Recovery When One Break is Restored.....	71.8
Configuration Examples.....	71.10
Single Domain, Single Ring Network.....	71.10
Single Ring, Dual Domain Network.....	71.15
EPSR and Spanning Tree Operation.....	71.16

Introduction

Ethernet Protection Switching Ring (EPSR) is a protection system that prevents loops within Ethernet ring based topologies. EPSR offers a rapid detection and recovery time (in the order of 50 ms, depending on configuration) if a link or node fails. This rapid recovery time makes EPSR a more effective alternative to spanning tree options when using ring-based topologies to create high speed resilient layer two networks.

Ring Components and Operation

EPSR operates only on ring-based topologies. An EPSR ring comprises a series of nodes (Ethernet bridges) connected end to end. The figure below shows a basic ring configuration. A ring comprises one master node and a number of transit nodes. Each node connects to the ring via two ports. On the master node one port is configured to be the primary port and the other, the secondary port.

Figure 71-1: Simple EPSR ring configuration

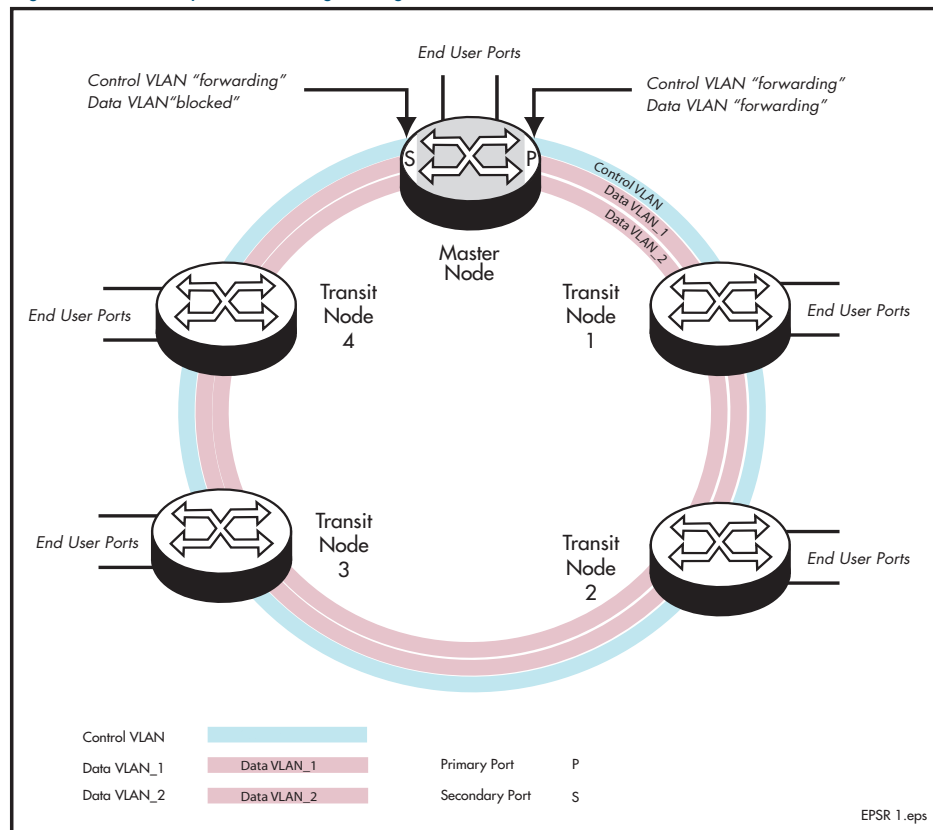

EPSR instances and domains

Each physical EPSR ring contains one or more EPSR instances. An EPSR instance can be thought of as a component of an EPSR ring existing on a single node. A set of instances across the whole ring is called a "domain." Therefore a ring whose individual nodes each have two instances results in a two domain ring. Each instance contains a control VLAN and a number of data VLANs.

The EPSR control VLAN and its associated data VLANs form a Ring Domain. Although a physical ring can have more than one domain, each domain must operate as a separate logical group of VLANs and must have its own master node. This means that several domains may share the same physical network, but must operate as logically separate VLAN groups.

- Control VLAN** The function of the control VLAN is to monitor the ring domain and maintain its operational functions. To do this it transmits and monitors operational healthcheck messages using EPSR healthcheck control frames. The control VLAN carries no user data.
- Data VLAN** The data VLAN carries the user data around the ring. Several data VLANs can share a common control VLAN.
- Master node** The master node controls the ring operation. It issues healthcheck messages at regular intervals from its primary port and monitors their arrival back at its secondary port - after they have circled the ring. Under normal operating conditions the master node's secondary port is always in the blocking state to all data VLAN traffic. This is to prevent data loops forming within the ring. This port however, operates in the forwarding state for the traffic on the control VLAN. Loops do not occur on the control VLAN because the control messages stop at the secondary port, having completed their path around the ring.
- Transit nodes** The transit nodes operate as conventional Ethernet bridges, but with the additional capability of running the EPSR protocol. This protocol requires the transit nodes to forward the healthcheck messages from the master node, and respond appropriately when a ring fault is detected. The fault condition procedure is explained in ["Fault Detection and Recovery"](#) on page 71.4.

Fault Detection and Recovery

EPSR uses the following methods to detect outages in a node or a link in the ring:

- Master node polling fault detection
- Transit node unsolicited fault detection

Master node polling

The master node issues healthcheck messages from its primary port as a means of checking the condition of the EPSR network ring. These messages are sent at regular periods, controlled by the **hellotime** parameter of the [epsr command on page 72.3](#). A failover timer is set each time a healthcheck message leaves the master node's primary port. The timeout value for this timer is set by the **failover** parameter of the [epsr command on page 72.3](#). If the failover timer expires before the transmitted healthcheck message is received by the master node's secondary port, the master node assumes that there is a fault in the ring, and implements its fault recovery procedures. Because this method relies on a timer expiry, its operation is inherently slower than the "transit node unsolicited detection method" described next.

Transit node unsolicited

Transmit note unsolicited fault detection relies on transit nodes detecting faults at their interfaces, and immediately notifying master nodes about the break. When a transit node detects a connectivity loss, it sends a "links down" message over its good link. Because a link spans two nodes, both nodes send the "links down" message back to the master node. These nodes also change their state from "links up" to "links down," and change the state of the port connecting to the broken link, from "forwarding" to "blocking."

Fault Recovery

When the master node detects an outage in the ring by using its detection methods, it does the following:

1. Declares the ring to be in a "failed" state.
2. Unblocks its secondary port to enable the data VLAN traffic to pass between its primary and secondary ports.
3. Flushes its own forwarding database (FDB) for (only) the two ring ports.
4. Sends an EPSR Ring-Down-Flush-FDB control message to all the transit nodes, via both its primary and secondary ports.

Transit nodes respond to the Ring-Down-Flush-FDB message by flushing their forward databases for each of their ring ports. As the data starts to flow in the ring's new configuration, each of the nodes (master and transit) re-learn their layer 2 addresses. During this period, the master node continues to send health check messages over the control VLAN. This situation continues until the faulty link or node is repaired. For a multi-domain ring, this process occurs separately for each domain within the ring.

Note  When VCStack is used with EPSR, the EPSR **failovertime** must be set to at least 5 seconds to avoid any broadcast storms during failover. Broadcast storms may occur if the switch cannot failover quickly enough before the EPSR **failovertime** expires. See the [epsr](#) command for further information about the EPSR **failovertime**. See the [reboot rolling](#) command for further information about VCStack failover.

The following figure shows the flow of control frames under fault conditions.

Figure 71-2: EPSR Fault Detection Messages

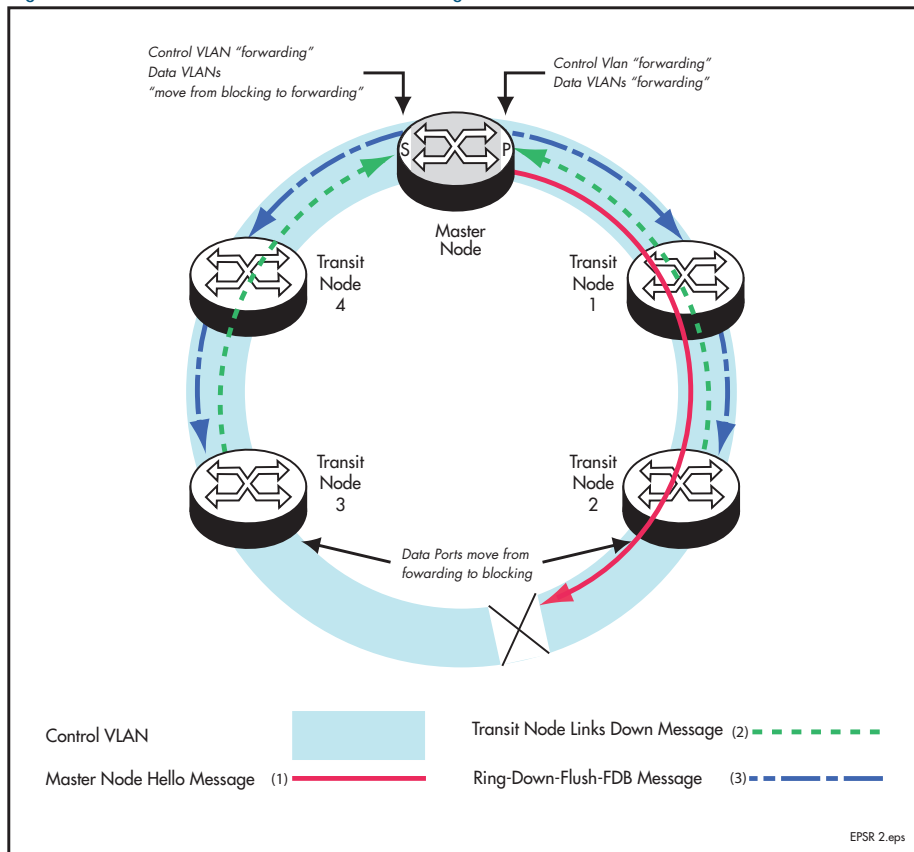

Restoring Normal Operation

Transit nodes Once a fault in the ring or node has been rectified, the transit nodes that span the previously faulty link section detect that link connectivity has returned. They then move their appropriate ring port state, from Links-Down to Pre-Forwarding, and await the Ring-Up-Flush control message from the master node.

Once these transit nodes receive the Ring-Up-Flush message, they:

- flush their forward databases for both their ring ports.
- change the state of their ports from blocking to forwarding, which allows data to flow through their previously blocked ring ports.

Note  The transit nodes do not enter the forward state until they have received the Ring-Up-Flush message. This prevents the possibility of a loop condition occurring caused by the transit nodes moving into the forwarding state before the master node secondary port can return to the blocking state. During such a period, the ring would have no ports blocked.

Master node With the link restored, the healthcheck messages that are sent from the primary port of the master node now complete the loop and arrive at the master node's secondary port. The master node restores normal conditions as follows:

1. Declares the ring to be in a "complete" state.
2. Blocks its secondary port for data (non-control) traffic.
3. Flushes its forwarding database for its two ring ports.
4. Sends a Ring-Up-Flush-FDB message from its primary port, to all transit nodes.

Managing Rings with Two Breaks

To restore a link with two breaks you need to run the EPSR Recovery feature. Consider the network shown below:

Figure 71-3: EPSR Ring with Two Breaks

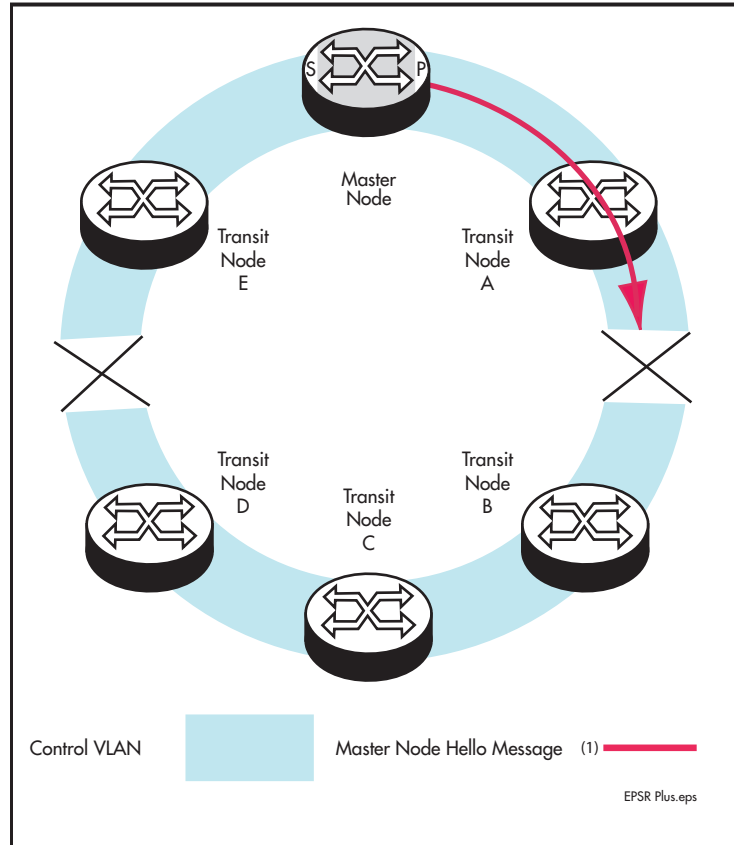

In this situation the ring will attempt to recover as previously described in “Fault Recovery” on page 71.4. This will result in the split-ring operation shown in Figure 71-4 on page 71.7.

Figure 71-4: EPSR Split Ring

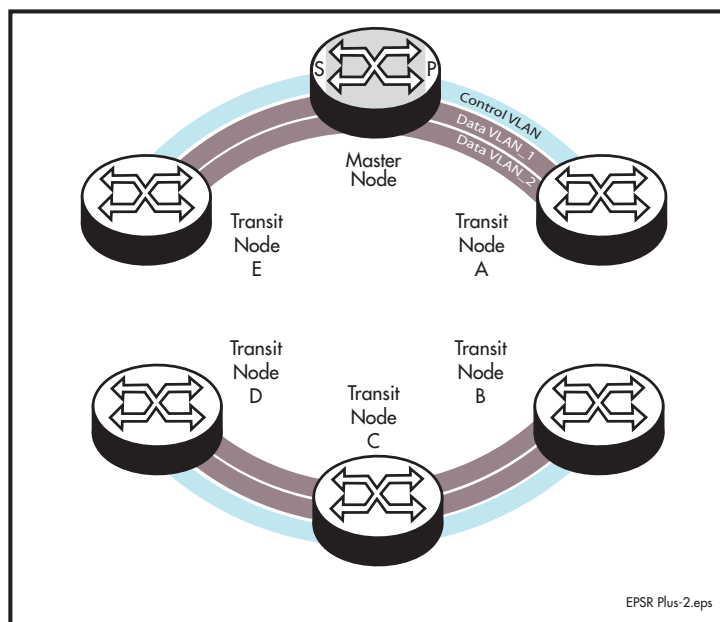

In this operational mode each portion of the ring operates as an independent link layer broadcast domain each containing the original data VLANs and control VLAN.

Recovery When One Break is Restored

Figure 71-5 on page 71.8 shows a ring with the link between nodes A and B restored. At this point the ring's behavior will depend on whether the `epsr enhancedrecovery enable` command on page 72.6 has been set.

Figure 71-5: EPSR Ring with One Link Restored

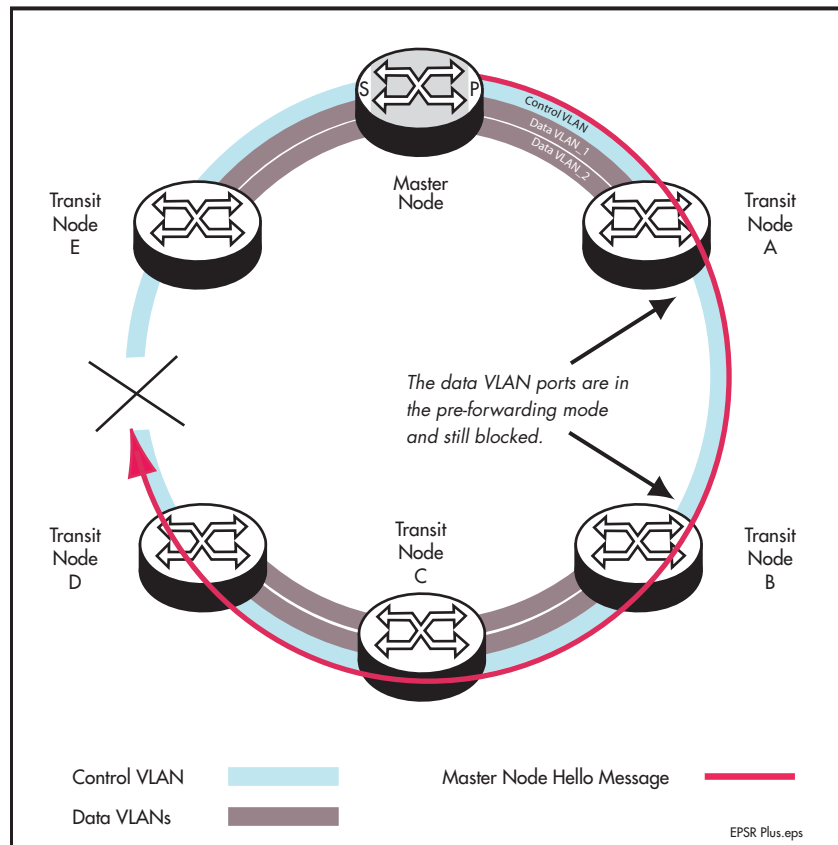

Enhanced Recovery Disabled

With the enhanced recovery feature turned enabled, the Hello messages will now reach the remaining ring break; however from a users perspective, the ring will remain as shown in the split state shown in Figure 71-5.

Enhanced Recovery Enabled

With the enhanced recovery feature turned enabled, switch nodes A and B are able to detect the restored link, and will place all their ring ports in the forwarding state. Although the ring will remain in the "failed" state because of the remaining break; communication between the nodes is restored. The network then operates as shown in Figure 71-6.

Configuration Examples

This section describes how to configure EPSR in following ways:

- Single Domain, Single Ring Network
- Single Ring, Dual Domain Network
- EPSR and Spanning Tree Operation

Single Domain, Single Ring Network

This example shows a simple single ring, single domain configuration with no connecting lobes.

Figure 71-7: EPSR single domain, single ring network

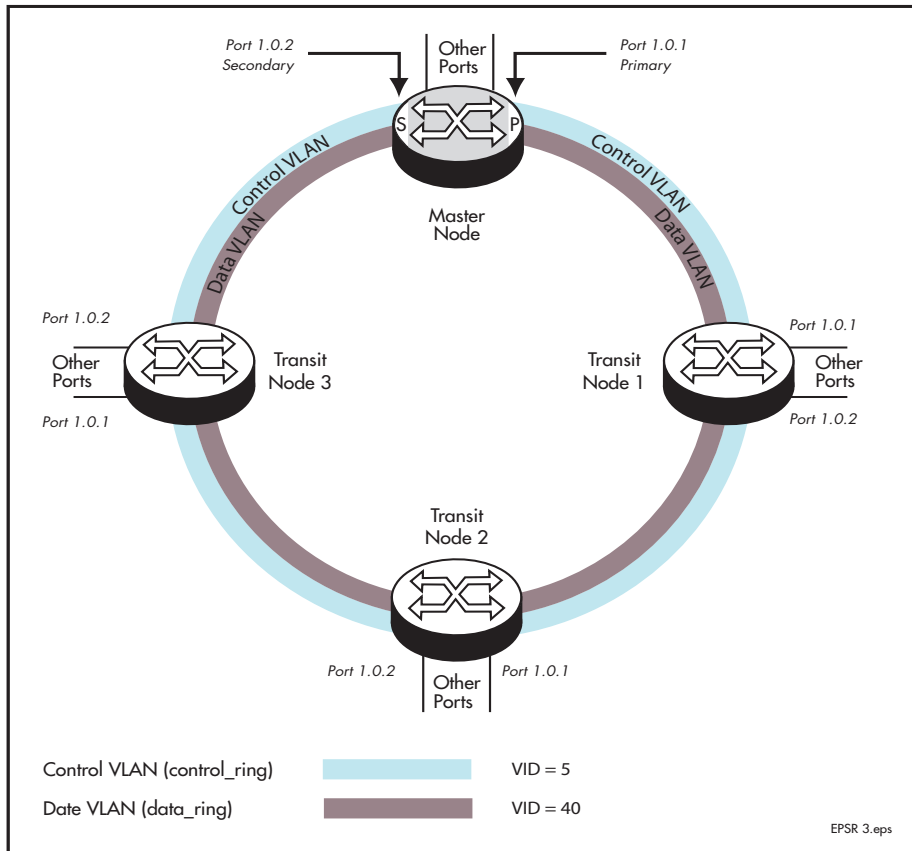

Configure the Master Node

Step 1: Create the control and data VLANs on the Master Node (bridge-group 1)

```

awplus#
configure terminal Enter the Global Configuration mode.
awplus(config)#
vlan database Enter the VLAN Configuration mode.
awplus(config-vlan)#
vlan 5 name control_vlan state enable Enable VLAN 5 called control_vlan on the Master
Node. Specifying the enable state allows forwarding of
frames on the VLAN-aware node.
awplus(config-vlan)#
vlan 40 name data_vlan state enable Enable VLAN 40 called data_vlan on the Master
Node. Specifying the enable state allows forwarding of
frames on the VLAN-aware node.
awplus(config-vlan)#
exit Exit the VLAN Configuration mode and enter the Global
Configuration mode.

```

Step 2: Add port port1.0.1 to these VLANs

```

awplus(config)#
interface port1.0.1 Specify the interface (port1.0.1) that you are
configuring and enter the Interface Configuration mode.
awplus(config-if)#
switchport mode trunk Set the switching characteristics of this port to trunk
mode.
awplus(config-if)#
switchport trunk allowed vlan add 5 Enable VLAN 5 on this port.
awplus(config-if)#
switchport trunk allowed vlan add 40 Enable VLAN 40 on this port.
awplus(config-if)#
exit Exit the Interface mode and enter the Global
Configuration mode.

```

Step 3: Add port port1.0.2 to these VLANs

<code>awplus(config)#</code>	
<code>interface port1.0.2</code>	Specify the interface (<code>port1.0.2</code>) that you are configuring and enter the Interface Configuration mode.
<hr/>	
<code>awplus(config-if)#</code>	
<code>switchport mode trunk</code>	Set the switching characteristics of this port to <code>trunk</code> mode.
<hr/>	
<code>awplus(config-if)#</code>	
<code>switchport trunk allowed vlan add 5</code>	Enable VLAN 5 on this port.
<hr/>	
<code>awplus(config-if)#</code>	
<code>switchport trunk allowed vlan add 40</code>	Enable VLAN 40 on this port.
<hr/>	
<code>awplus(config-if)#</code>	
<code>exit</code>	Exit the Interface Configuration mode and enter the Global Configuration mode.

Step 4: Create the EPSR Instance called "blue" on the master node, make VLAN 5 the control VLAN and port 1.0.1 the primary port

<code>awplus(config)#</code>	
<code>epsr configuration</code>	Enter the EPSR Configuration mode.
<hr/>	
<code>awplus(config-epsr)#</code>	
<code>epsr blue mode master controlvlan 5</code>	Create an EPSR instance called <code>blue</code> on <code>vlan5</code> .
<code>primaryport port1.0.1</code>	Make <code>vlan5</code> the control VLAN Make <code>port 1.0.1</code> the primary port. Make this node the master.

Step 5: Add a data VLAN to the EPSR Instance called "blue" on the Master Node

<code>awplus(config-epsr)#</code>	
<code>epsr blue datavlan 40</code>	On epsr instance called <code>blue</code> make <code>vlan40</code> the data vlan.

Step 6: Enable the EPSR Instance called "blue" on the Master Node

<code>awplus(config-epsr)#</code>	
<code>epsr blue state enable</code>	Enable the EPSR instance named <code>blue</code>
<hr/>	
<code>awplus(config-epsr)#</code>	
<code>exit</code>	Exit the EPSR Configuration mode.

Now you can configure the transit nodes.

Step 7: Create the Control and Data VLANs on a Transit Node

```

awplus#
configure terminal Enter the Global Configuration mode.
awplus(config)#
vlan database Enter the VLAN Configuration mode.
awplus(config-vlan)#
vlan 5 name control_vlan state enable Enable VLAN 5 called control_vlan on the Transit
Node. Specifying the enable state allows forwarding of
frames on the VLAN-aware node.
awplus(config-vlan)#
vlan 40 name data_vlan state enable Enable VLAN 40 called data_vlan on the Transit
Node. Specifying the enable state allows forwarding of
frames on the VLAN-aware node.
awplus(config-vlan)#
exit Exit the VLAN Configuration mode and enter the Global
Configuration mode.

```

Step 8: Add port port1.0.1 to the VLANs

```

awplus(config)#
interface port1.0.1 Specify the interface (port1.0.1) that you are
configuring and enter the Interface Configuration mode.
awplus(config-if)#
switchport mode trunk Set the switching characteristics of this port to trunk
mode.
awplus(config-if)#
switchport trunk allowed vlan add 5 Enable VLAN 5 on this port.
awplus(config-if)#
switchport trunk allowed vlan add 40 Enable VLAN 40 on this port.
awplus(config-if)#
exit Exit the Interface Configuration mode and enter the
Global Configuration mode.

```

Step 9: Add port port1.0.2 to the VLANs

<code>awplus(config)#</code>	
<code>interface port1.0.2</code>	Specify the interface (<code>port1.0.2</code>) that you are configuring and enter the Interface Configuration mode.
<hr/>	
<code>awplus(config-if)#</code>	
<code>switchport mode trunk</code>	Set the switching characteristics of this port to <code>trunk</code> mode.
<hr/>	
<code>awplus(config-if)#</code>	
<code>switchport trunk allowed vlan add 5</code>	Enable VLAN 5 on this port.
<hr/>	
<code>awplus(config-if)#</code>	
<code>switchport trunk allowed vlan add 40</code>	Enable VLAN 40 on this port.
<hr/>	
<code>awplus(config-if)#</code>	
<code>exit</code>	Exit the Interface Configuration mode and enter the Global Configuration mode.

Step 10: Create the EPSR Instance called "blue" on a transit node, make VLAN 5 the control VLAN

<code>awplus(config)#</code>	
<code>epsr configuration</code>	Enter the Global Configuration mode.
<hr/>	
<code>awplus(config-epsr)#</code>	
<code>epsr blue mode transit controlvlan 5</code>	Create an EPSR instance called <code>blue</code> on <code>vlan5</code> . Make <code>vlan5</code> the control vlan. Make this node a transit node.

Step 11: Add a data VLAN to the EPSR Instance called "blue" on the transit node

<code>awplus(config-epsr)#</code>	
<code>epsr blue datavlan 40</code>	On the EPSR instance called <code>blue</code> make <code>vlan40</code> the data vlan.

Step 12: Enable the EPSR Instance called "blue" on the transit node

<code>awplus(config-epsr)#</code>	
<code>epsr blue state enable</code>	Enable the EPSR instance named <code>blue</code>
<hr/>	
<code>awplus(config-epsr)#</code>	
<code>exit</code>	Exit the EPSR Configuration mode.

Now you can use the same procedure to configure the remaining transit nodes.

Single Ring, Dual Domain Network

This example shows an EPSR configuration where two EPSR domains share the same physical ring. This configuration enables two sets of users to run totally separate layer two networks. Better load distribution around the ring can be achieved by configuring different nodes to be the master for each ring.

Figure 71-8: EPSR single ring network, two domain network.

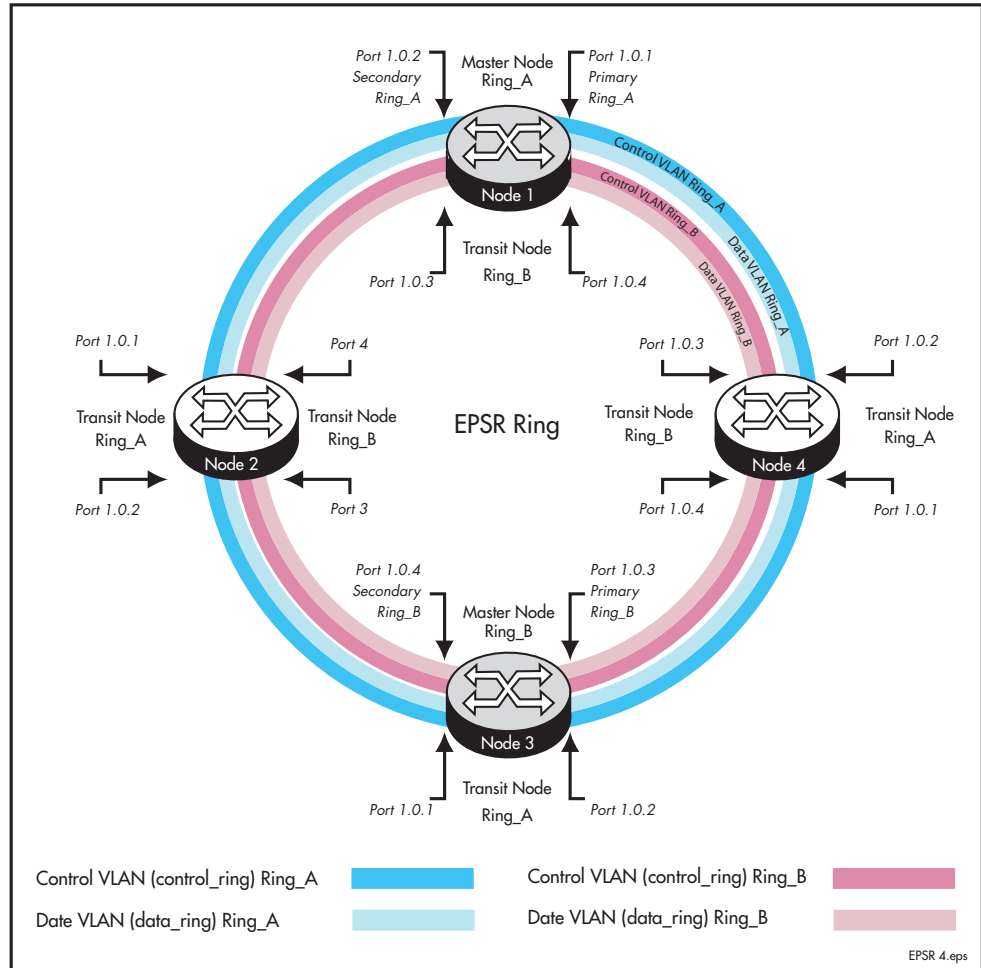

EPSR and Spanning Tree Operation

EPSR and the Spanning Tree protocol (STP) address data loop prevention, although they do it differently. EPSR is manually configured to explicitly identify which links are broken in the defined ring, whereas STP/RSTP calculates where to break links based on user-provided values (metrics) that are compared to determine the "best" (or lowest cost) paths for data traffic.

At the practical level you can use these two techniques to create complementary hybrid EPSR /STP configurations. This configuration might have a high speed fibre loop topology backbone-controlled and managed using EPSR. Lobes could extend out from each loop node into a user mesh network. Any loops in this mesh network would be controlled and managed using STP/RSTP. Note that EPSR and STP cannot share the same ports.

The following figure shows a basic combined EPSR / STP network.

Figure 71-9: EPSR and spanning tree operation

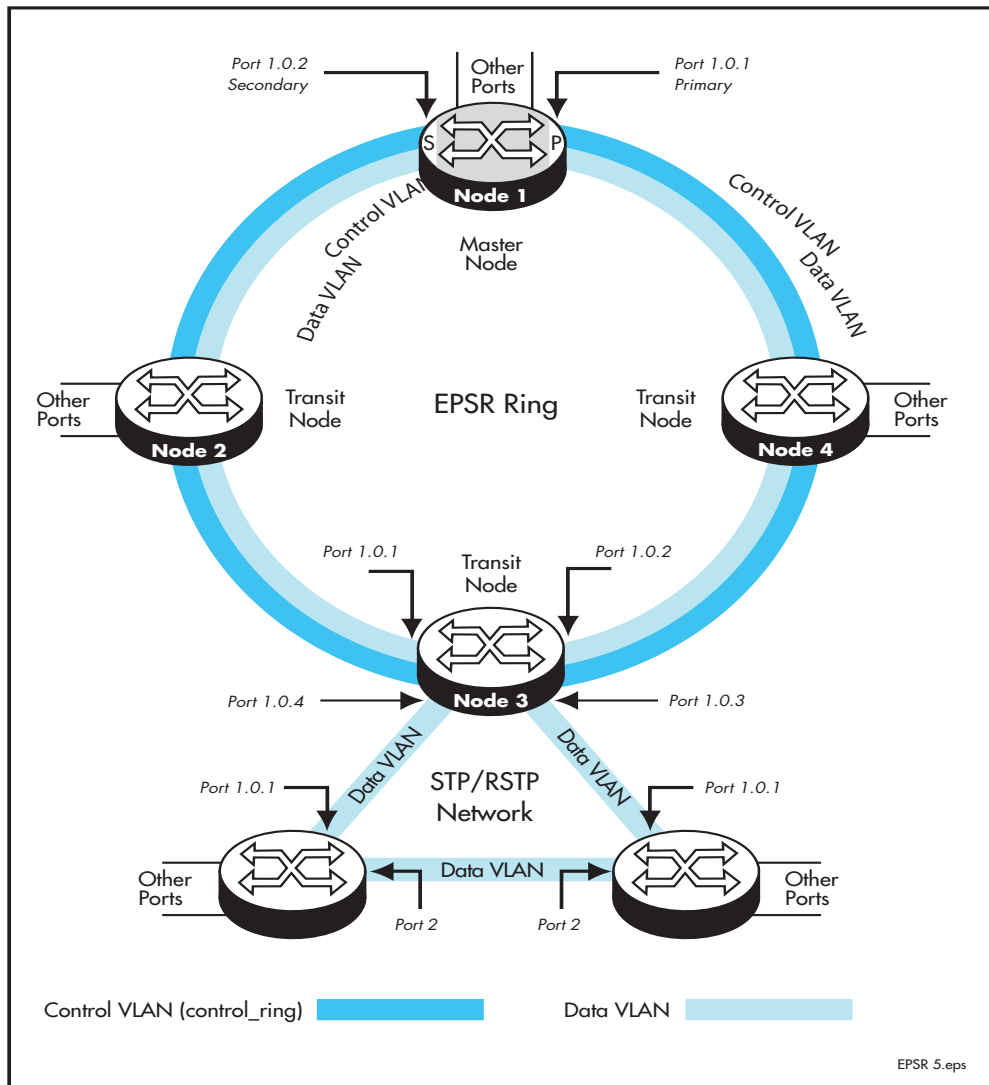

Chapter 72: EPSR Commands



Command List	72.2
debug epsr	72.2
epsr	72.3
epsr configuration	72.4
epsr datavlan	72.5
epsr enhancedrecovery enable	72.6
epsr mode master controlvlan primaryport	72.7
epsr mode transit controlvlan	72.8
epsr state	72.9
epsr trap	72.10
show debugging epsr	72.10
show epsr	72.11
show epsr word	72.11
show epsr word counters	72.12
show epsr counters	72.12
undebg epsr	72.12

Command List

This chapter provides an alphabetical reference for commands used to configure EPSR. For more information, see [Chapter 71, EPSR Introduction](#).

For information about modifying or redirecting the output from **show** commands to a file, see [“Controlling “show” Command Output” on page 1.35](#).

debug epsr

This command enables EPSR debugging.

The **no** variant of this command disables EPSR debugging.

Syntax `debug epsr {info|msg|pkt|state|all}`
`no debug epsr {info|msg|pkt|state|all}`

Parameter	Description
<code>info</code>	Echo general EPSR information to console. Do not echo general EPSR information to console (when negated).
<code>msg</code>	Echo decoded display of received and transmitted EPSR packets to console. Do not echo decoded display of received and transmitted EPSR packets to console.
<code>pkt</code>	Echo raw ASCII display of received and transmitted EPSR packets to console. Do not echo raw ASCII display of received and transmitted EPSR packets to console.
<code>state</code>	Echo EPSR state transitions to console.
<code>all</code>	Turn on all EPSR debugging.

Mode Privileged Exec

Examples To enable state transition debugging, use the command:

```
awplus# debug epsr state
```

To disable EPSR packet debugging, use the command::

```
awplus# no debug epsr pkt
```

Related Commands [undebug epsr](#)

epsr

This command sets the timer values for an EPSR instance. It is only valid for master nodes.

The **no** variant of this command destroys an EPSR instance.

Syntax

```
epsr <epsr-name> {hellotime <1-32767>|failovertime <2-65535>|
ringflaptime <0-65535>}
no epsr <epsr-name>
```

Parameter	Description
<epsr-name>	Name of the EPSR instance.
hellotime <1-32767>	The interval between transmitting health check messages in seconds.
failovertime <2-65535>	The period a master waits for a health check before declaring a broken ring in seconds.
ringflaptime <0-65535>	The minimum period that a master must remain in the failed state in seconds.

Mode EPSR Configuration

Examples To set the hellotimer to 5 seconds for the EPSR instance called `blue`, use the command:

```
awplus(config-epsr)# epsr blue hellotime 5
```

Note  The failovertime must be at least twice the hellotime, or the hellotime must be less than equal to half the failovertime. Do not set hellotime at or below failovertime.

Note  When VCStack is used with EPSR, the EPSR **failovertime** must be set to at least 5 seconds to avoid any broadcast storms during failover. Broadcast storms may occur if the switch cannot failover quickly enough before the EPSR **failovertime** expires. See the [reboot rolling](#) command for further information about VCStack failover.

To destroy an EPSR instance called `blue`, use the command:

```
awplus(config-epsr)# no epsr blue
```

Related Commands

- [epsr mode master controlvlan primaryport](#)
- [epsr mode transit controlvlan](#)
- [epsr configuration](#)
- [epsr datavlan](#)
- [epsr state](#)
- [epsr trap](#)
- [reboot rolling](#)
- [show epsr](#)

epsr configuration

Use this command to enter EPSR Configuration mode so that EPSR can be configured.

Syntax `epsr configuration`

Mode Global Configuration

Example To change to EPSR mode, use the command:

```
awplus(config)# epsr configuration
```

Related Commands `epsr mode master controlvlan primaryport`
`epsr`
`show epsr`

epsr datavlan

This command adds a data VLAN or a range of VLAN identifiers to a specified EPSR instance. The **no** variant of this command removes a data vlan or data vlan range from an EPSR instance.

Syntax

```
epsr <epsr-name> datavlan {<vlanid>|<vlanid-range>}
no epsr <epsr-name> datavlan {<vlanid>|<vlanid-range>}
```

Parameter	Description
<epsr-name>	Name of the EPSR instance.
datavlan	Adds a data VLAN to be protected by the EPSR instance.
<vlanid>	The VLAN's VID - a number between 1 and 4094 excluding the number selected for the control VLAN.
<vlanid-range>	Specified a range of VLAN identifiers using hyphen to separate identifiers.

Mode EPSR Configuration

Usage We suggest setting the epsr controlvlan to vlan2 using the [epsr mode master controlvlan primaryport](#) and [epsr mode transit controlvlan](#) commands, then setting the EPSR data VLAN between to be a value 3 and 4094 using the [epsr datavlan](#) command.

Examples To add `vlan3` to the EPSR instance called `blue`, use the command:

```
awplus(config-epsr)# epsr blue datavlan vlan3
```

To add `vlan2` and `vlan3` to the EPSR instance called `blue`, use the command:

```
awplus(config-epsr)# epsr blue datavlan vlan2-vlan3
```

To remove `vlan3` from the EPSR instance called `blue`, use the command:

```
awplus(config-epsr)# no epsr blue datavlan vlan3
```

To remove `vlan2` and `vlan3` from the EPSR instance called `blue`, use the command:

```
awplus(config-epsr)# no epsr blue datavlan vlan2-vlan3
```

Related Commands

- [epsr mode master controlvlan primaryport](#)
- [epsr mode transit controlvlan](#)
- [show epsr](#)

epsr enhancedrecovery enable

This command enables EPSR's enhanced recovery mode. Enhanced recovery mode enables a ring to apply additional recovery procedures when a ring with more than one break, partially mends. For more information see, "[Managing Rings with Two Breaks](#)" on page 71.7.

The **no** variant of this command disables the enhancedrecovery mode.

Syntax `epsr <epsr-name> enhancedrecovery enable`
`no epsr <epsr-name> enhancedrecovery enable`

Parameter	Description
<code><epsr-name></code>	Name of the EPSR instance.

Default Default is enhancedrecovery mode disabled.

Mode EPSR Configuration

Example To apply enhanced recovery on the EPSR instance called `blue`, use the command:

```
awplus(config-epsr)# epsr blue enhancedrecovery enable
```

Related Commands `show epsr`

epsr mode master controlvlan primaryport

This command creates a master EPSR instance.

Syntax `epsr <epsr-name> mode master controlvlan <2-4094> primaryport <port>`

Parameter	Description
<epsr-name>	Name of the EPSR instance.
mode	Determines the node is acting as a master.
master	Sets switch to be the master node for the named EPSR ring.
controlvlan	The VLAN that will transmit EPSR control frames.
<2-4094>	VLAN id.
primaryport	Primary port for the EPSR instance.
<port>	The primary port. The port may be a switch port (e.g. port1.1.4) or a static channel group (e.g. sa3). It cannot be a dynamic (LACP) channel group.

Note  The software allows you to configure more than two ports or static channel groups to the control VLAN within a single switch or stacked node. However, we advise against this because in certain situations it can produce unpredictable results. If the control VLAN contains more than two ports (or static channels) an algorithm selects the two ports or channels with the lowest number to be the ring ports. However if the switch has only one channel group is defined to the control vlan, EPSR will not operate on the secondary port. EPSR does not support Dynamic link aggregation (LACP).

Mode EPSR Configuration

Example To create a master EPSR instance called `blue` with `vlan2` as the control VLAN and `port1.0.1` as the primary port, use the command:

```
awplus(config-epsr)# epsr blue mode master controlvlan vlan2
primaryport port1.0.1
```

Related Commands `epsr mode transit controlvlan`
`show epsr`

epsr mode transit controlvlan

This command creates a transit EPSR instance.

Syntax `epsr <epsr-name> mode transit controlvlan <2-4094>`

Parameter	Description
<code><epsr-name></code>	Name of the EPSR instance.
<code>mode</code>	Determines the node is acting as a transit node.
<code>transit</code>	Sets switch to be the transit node for the named EPSR ring.
<code>controlvlan</code>	The VLAN that will transmit EPSR control.
<code><2-4094></code>	VLAN id.

Note  The software allows you to configure more than two ports or static channel groups to the control VLAN within a single switch or stacked node. However, we advise against this because in certain situations it can produce unpredictable results. If the control VLAN contains more than two ports (or static channels) an algorithm selects the two ports or channels with the lowest number to be the ring ports. However if the switch has only one channel group is defined to the control vlan, EPSR will not operate on the secondary port. EPSR does not support Dynamic link aggregation (LACP).

Mode EPSR Configuration

Example To create a transit EPSR instance called `blue` with `vlan2` as the control VLAN, use the command:

```
awplus(config-epsr)# epsr blue mode transit controlvlan vlan2
```

Related Commands [epsr mode master controlvlan primaryport](#)
[epsr mode transit controlvlan](#)
[show epsr](#)

epsr state

This command enables or disables an EPSR instance.

Syntax `epsr <epsr-name> state {enabled|disabled}`

Parameter	Description
<code><epsr-name></code>	The name of the EPSR instance.
<code>state</code>	The operational state of the ring.
<code>enabled</code>	EPSR instance is enabled.
<code>disabled</code>	EPSR instance is disabled.

Mode EPSR Configuration

Example To enable the EPSR instance called `blue`, use the command:

```
awplus(config-epsr)# epsr blue state enabled
```

Related Commands [epsr mode master controlvlan primaryport](#)
[epsr mode transit controlvlan](#)

epsr trap

This command enables SNMP traps for an EPSR instance. The traps will be sent when the EPSR instance changes state.

The **no** variant of this command disables SNMP traps for an EPSR instance. The traps will no longer be sent when the EPSR instance changes state.

Syntax `epsr <epsr-name> trap`
`no epsr <epsr-name> trap`

Parameter	Description
<code><epsr-name></code>	Name of the EPSR instance.
<code>trap</code>	SNMP trap for the EPSR instance.

Mode EPSR Configuration

Example To enable traps for the EPSR instance called `blue`, use the command:

```
awplus(config-epsr)# epsr blue trap
```

To disable traps for the EPSR instance called `blue`, use the command:

```
awplus(config-epsr)# no epsr blue trap
```

Related Commands `epsr mode master controlvlan primaryport`
`epsr mode transit controlvlan`
`show epsr`

show debugging epsr

This command shows the debugging modes enabled for EPSR.

Syntax `show debugging epsr`

Mode User Exec and Privileged Exec

Example To show the enabled debugging modes, use the command:

```
awplus# show debugging epsr
```

Related Commands `debug epsr`

show epsr

This command displays information about all EPSR instances.

Syntax `show epsr`

Mode User Exec and Privileged Exec

Example To show the current settings of all EPSR instances, use the command:

```
awplus# show epsr
```

Related Commands [epsr mode master controlvlan primaryport](#)
[epsr mode transit controlvlan](#)
[show epsr counters](#)

show epsr word

This command displays information about the specified EPSR instance.

Syntax `show epsr <epsr-name>`

Parameter	Description
<code><epsr-name></code>	Name of the EPSR instance.

Mode User Exec and Privileged Exec

Example To show the current settings of the EPSR instance called `blue`, use the command:

```
awplus# show epsr blue
```

Related Commands [epsr mode master controlvlan primaryport](#)
[epsr mode transit controlvlan](#)
[show epsr counters](#)

show epsr word counters

This command displays counter information about the specified EPSR instance.

Syntax `show epsr <epsr-name> counters`

Parameter	Description
<code><epsr-name></code>	Name of the EPSR instance.

Mode User Exec and Privileged Exec

Example To show the counters of the EPSR instance called `blue`, use the command:

```
awplus# show epsr blue counters
```

Related Commands [epsr mode master controlvlan primaryport](#)
[epsr mode transit controlvlan](#)
[show epsr](#)

show epsr counters

This command displays counter information about all EPSR instances.

Syntax `show epsr counters`

Mode User Exec and Privileged Exec

Example To show the counters of all EPSR instances, use the command:

```
awplus# show epsr counters
```

Related Commands [epsr mode master controlvlan primaryport](#)
[epsr mode transit controlvlan](#)
[show epsr](#)

undebg epsr

This command applies the functionality of the [no debug epsr command on page 72.2](#).

Part 7: Network Management



- Chapter 73 NTP Introduction
- Chapter 74 NTP Commands
- Chapter 75 Dynamic Host Configuration Protocol (DHCP) Introduction
- Chapter 76 Dynamic Host Configuration Protocol (DHCP) Commands
- Chapter 77 SNMP Introduction
- Chapter 78 SNMP Commands
- Chapter 79 SNMP MIBs
- Chapter 80 LLDP Introduction
- Chapter 81 LLDP Commands
- Chapter 82 SMTP Commands
- Chapter 83 RMON Introduction
- Chapter 84 RMON Commands
- Chapter 85 Triggers Introduction
- Chapter 86 Triggers Configuration
- Chapter 87 Trigger Commands
- Chapter 88 Ping Polling Introduction
- Chapter 89 Ping Polling Commands
- Chapter 90 sFlow Introduction
- Chapter 91 sFlow Commands

Chapter 73: NTP Introduction



Introduction.....	73.2
Overview.....	73.2
NTP on the Switch.....	73.3
Troubleshooting.....	73.4
Configuration Example.....	73.5

Introduction

This chapter describes the Network Time Protocol (NTP) service provided by the switch, and how to configure and monitor NTP on the switch.

NTP is a protocol for synchronizing the time clocks on a collection of network devices using a distributed client/server mechanism. NTP uses UDP (User Datagram Protocol) as the transport mechanism. NTP evolved from the Time Protocol (RFC 868) and the ICMP Timestamp message (RFC 792).

NTP provides protocol mechanisms to specify the precision and estimated error of the local clock and the characteristics of the reference clock to which it may be synchronized.

For detailed information about the commands used to configure NTP, see [Chapter 74, NTP Commands](#).

Overview

NTP uses a subnetwork with primary reference clocks, gateways, secondary reference clocks, and local hosts. These are organized into a hierarchy with the more accurate clocks near the top and less accurate ones near the bottom.

A number of primary reference clocks, synchronized to national standards, are connected to widely accessible resources (such as backbone gateways or switches) operating as primary time servers. The primary time servers use NTP between them to crosscheck clocks, to mitigate errors due to equipment or propagation failures, and to distribute time information to local secondary time servers. The secondary time servers redistribute the time information to the remaining local hosts.

The hierarchical organization and distribution of time information reduces the protocol overhead, and allows selected hosts to be equipped with cheaper but less accurate clocks. NTP provides information which organizes this hierarchy on the basis of precision or estimated error.

- An NTP entity may be in one of the following operating modes; however, the switch's implementation of NTP supports two modes: client and server.
- An NTP entity operating in a client mode sends periodic messages to its peers, requesting synchronization by its peers.
- An NTP entity enters the server mode temporarily when it receives a client request message from one of its peers, and remains in server mode until the reply to the request has been transmitted.
- An NTP entity operating in symmetric active mode sends messages announcing its willingness to synchronize and be synchronized by its peers.
- An NTP entity enters symmetric passive mode in response to a message from a peer operating in Symmetric Active mode. An NTP entity operating in this mode announces its willingness to synchronize and be synchronized by its peers.
- An NTP entity operating in broadcast mode periodically sends messages announcing its willingness to synchronize all of its peers but not to be synchronized by any of them.

The same message format is used for both requests and replies. When a request is received, the server interchanges addresses and ports, fills in or overwrites certain fields in the message, recalculates the checksum, and returns it immediately. The information included in the NTP message allows each client/ server peer to determine the timekeeping characteristics of its peers, including the expected accuracies of their clocks. Each peer uses this information and

selects the best time from possibly several other clocks, updates the local clock, and estimates its accuracy.

There is no provision in NTP for peer discovery, acquisition, or authentication. Data integrity is provided by the IP and UDP checksums. No reachability, circuit-management, duplicate-detection, or retransmission facilities are provided or necessary.

By its very nature clock synchronization requires long periods of time (hours or days) and multiple comparisons in order to maintain accurate timekeeping. The more comparisons performed, the greater the accuracy of the timekeeping.

NTP on the Switch

The implementation of NTP on the switch is based on the following RFCs:

- [RFC 958, Network Time Protocol \(NTP\)](#)
- [RFC 1305, Network Time Protocol \(Version 3\) Specification, Implementation and Analysis](#)
- [RFC 1510, The Kerberos Network Authentication Service \(V5\)](#)

Two modes of operation are supported: client and server. The switch is in client mode most of the time where it polls the configured peer at least once every preconfigured minimum time period.

The peer that the switch refers to must be a more accurate clock source than the switch itself or another switch directly connected to a more accurate clock source. The switch operates as a secondary time server. It cannot operate as a primary time server unless the primary clock source is operating in server mode. A primary clock source usually operates in broadcast mode, which is not supported by the switch's implementation of NTP. There is no support for clock selection or filtering. When the switch receives a valid reply from the peer, it synchronizes its own internal clock according to the information from the reply.

If the switch receives a synchronization request from an NTP client, it temporarily changes to server mode. It replies to the request with the current time from the switch's internal clock along with other information useful for synchronization. The switch's internal clock is accurate to 0.005 seconds.

Troubleshooting

Problem The switch is not assigning the time to devices on the LAN.

- Solutions**
- Check that the NTP peer's IP address is entered correctly.
 - Check that the NTP peer can reach the switch, by pinging the switch from the NTP peer.

Problem The switch's clock does not synchronize with the NTP peer.

- Solution**
- The switch's clock can synchronize with the NTP peer only when its initial time is similar to the NTP peer's time (after setting the UTC offset). Manually set the switch's time so that it is approximately correct, and enable NTP again.
 - Check that the UTC offset is correct.

Problem The switch's time is incorrect, even though it assigns the correct time to devices on the LAN.

Solution The UTC offset is probably incorrect, or needs to be adjusted for the beginning or end of summer time.

Configuration Example

NTP requires the IP module to be enabled and configured correctly.

The switch's implementation of NTP supports two modes: client and server mode. When a synchronization request is received from a client (e.g. a PC on a LAN), the switch enters server mode and responds with time information derived from the switch's own internal clock. Periodically the switch enters client mode, sending synchronization requests to a predefined peer to synchronize its own internal clock. The peer is assumed to be a primary clock source or another switch connected directly to a primary clock source.

This example illustrates how to configure two switches, one at a Head Office and one at a Regional Office, to provide a network time service. The Head Office switch is connected to a primary time server and provides the most accurate time information. The switch at the Regional Office uses the Head Office switch as its peer to avoid the cost of an additional WAN connection but provides slightly less accurate time information.

To configure NTP on the switch, the NTP module must be enabled and an NTP peer must be defined. NTP transfers time information in UTC format.

To set the switch to automatically change the time when summer time starts and ends, enable a summer time offset setting.

Example configuration parameters for a network time service:

Site	Regional Office	Head Office
Switch Name	RG1	HO1
IP Address of Switch	192.168.35.114	192.168.35.113
IP Address of Peer	192.168.35.113	192.168.13.3

Step 1: Enable NTP and define the NTP peer.

The NTP feature must be enabled on all switches that are to provide a network time service. Each switch must have a peer defined where the switch synchronizes its own internal clock. Enable NTP on the Head Office switch and specify a primary time server as the peer by using the commands:

```
awplus# configure terminal
awplus(config)# ntp peer 192.168.13.3
```

Step 2: Configure the NTP parameters.

On each switch, the offset of local time from UTC time must be specified. In this example, both switches are in the same time zone, which is 12 hours ahead of UTC time. Use the following commands on both switches:

```
awplus(config)# clock timezone utc plus 12
```

Note that the range of offset is <0-12>.

Step 3: Check the NTP configuration.

Check the NTP configuration on each switch by using the command:

```
awplus# show ntp status
```

This command displays the following information on the Head Office switch.

```
Clock is synchronized, stratum 0, actual frequency is 0.0000  
Hz, precision is 20 reference time is 00000000.00000000  
(6:28:16.000 UTC Fri Feb 7 2036)clock offset is 0.000 msec,  
root delay is 0.000 msec root dispersion is 0.000 msec,
```

Chapter 74: NTP Commands



Command List	74.2
ntp access-group	74.2
ntp authenticate	74.3
ntp authentication-key	74.4
ntp broadcastdelay	74.5
ntp master	74.6
ntp peer	74.7
ntp server	74.8
ntp trusted-key	74.9
show counter ntp	74.10
show ntp associations	74.11
show ntp status	74.12

Command List

This chapter provides an alphabetical reference for commands used to configure the Network Time Protocol (NTP). For more information, see [Chapter 73, NTP Introduction](#).

For information about modifying or redirecting the output from **show** commands to a file, see [“Controlling “show” Command Output” on page 1.35](#).

ntp access-group

This command creates an NTP access group, and applies a basic IP access list to it. This allows you to control access to NTP services.

The **no** variant of this command removes the configured NTP access group.

Syntax

```
ntp access-group [peer | query-only | serve | serve-only]
                [<1-99> | <1300-1999>]

no ntp access-group [peer | query-only | serve | serve-only]
```

Parameter	Description
peer	Allows time requests and NTP control queries, and allows the system to synchronize itself to a system whose address passes the access list criteria.
query-only	Allows only NTP control queries from a system whose address passes the access list criteria.
serve	Allows time requests and NTP control queries, but does not allow the system to synchronize itself to a system whose address passes the access list criteria.
serve-only	Allows only time requests from a system whose address passes the access list criteria.
<1-99>	Standard IP access list.
<1300-1999>	Expanded IP access list.

Mode Global Configuration

Example To create an NTP peer access group for an extended IP access list, use the commands:

```
awplus# configure terminal
awplus(config)# ntp access-group peer 1998
```

To disable the NTP peer access group created above, use the commands:

```
awplus# configure terminal
awplus(config)# no ntp access-group peer
```

ntp authenticate

This command enables NTP authentication. This allows NTP to authenticate the associations with other systems for security purposes.

The **no** variant of this command disables NTP authentication.

Syntax ntp authenticate
no ntp authenticate

Mode Global Configuration

Example To enable NTP authentication, use the commands:

```
awplus# configure terminal
awplus(config)# ntp authenticate
```

To disable NTP authentication, use the commands:

```
awplus# configure terminal
awplus(config)# no ntp authenticate
```

ntp authentication-key

This command defines each of the authentication keys. Each key has a key number, a type, and a value. Currently, the only key type supported is MD5.

The **no** variant of this disables the authentication key assigned previously using **ntp authentication-key**.

Syntax `ntp authentication-key <keynumber> md5 <key>`
`no ntp authentication-key <keynumber> md5 <key>`

Parameter	Description
<code><keynumber></code>	<code><1-4294967295></code> The key number.
<code><key></code>	The authentication key.

Mode Global Configuration

Example To define an authentication key number 134343 and a key value `mystring`, use the commands:

```
awplus# configure terminal
awplus(config)# ntp authentication-key 134343 md5 mystring
```

To disable the authentication key number 134343 with the key value `mystring`, use the commands:

```
awplus# configure terminal
awplus(config)# no ntp authentication-key 134343 md5 mystring
```

ntp broadcastdelay

Use this command to set the estimated round-trip delay for broadcast packets.

Use the **no** variant of this command to reset the round-trip delay for broadcast packets to the default offset of 0 microseconds.

Syntax `ntp broadcastdelay <delay>`
`no ntp broadcastdelay`

Parameter	Description
<code><delay></code>	<code><1-999999></code> The broadcast delay in microseconds.

Default 0 microsecond offset, which can only be applied with the **no** variant of this command.

Mode Global Configuration

Example To set the estimated round-trip delay to 23464 microseconds for broadcast packets, use these commands:

```
awplus# configure terminal
awplus(config)# ntp broadcastdelay 23464
```

To reset the estimated round-trip delay for broadcast packets to the default setting (0 microseconds), use these commands:

```
awplus# configure terminal
awplus(config)# no ntp broadcastdelay
```

ntp master

Use this command to make the device to be an authoritative NTP server, even if the system is not synchronized to an outside time source. Note that no stratum number is set by default.

Use the **no** variant of this command to stop the device being the designated NTP server.

Syntax `ntp master [<stratum>]`

`no ntp master`

Parameter	Description
<stratum>	<1-15> The stratum number.

Mode Global Configuration

Usage The stratum number is null by default and must be set using this command. The stratum levels define the distance from the reference clock and exist to prevent cycles in the hierarchy. Stratum 1 is used to indicate time servers, which are more accurate than Stratum 2 servers.

Examples To stop the switch from being the designated NTP server use the commands:

```
awplus# configure terminal
awplus(config)# no ntp master
```

To make the switch the designated NTP server with stratum number 2 use the commands:

```
awplus# configure terminal
awplus(config)# ntp master 2
```

ntp peer

Use this command to configure an NTP peer association. An NTP association is a peer association if this system is willing to either synchronize to the other system, or allow the other system to synchronize to it.

Use the **no** variant of this command to remove the configured NTP peer association.

Syntax

```
ntp peer {<peeraddress>|<peername>}
ntp peer {<peeraddress>|<peername>}
    [prefer] [key <key>] [version <version>]
no ntp peer {<peeraddress>|<peername>}
```

Parameter	Description
<peeraddress>	Specify the IP address of the peer, entered in the form A.B.C.D.
<peername>	Specify the peer hostname.
prefer	Prefer this peer when possible.
key <key>	<1-4294967295> Configure the peer authentication key.
version <version>	<1-4> Configure for this NTP version.

Mode Global Configuration

Examples See the following commands for options to configure NTP peer association, key and NTP version for the peer with an IP address of 192.0.2.23:

```
awplus# configure terminal
awplus(config)# ntp peer 192.0.2.23
awplus(config)# ntp peer 192.0.2.23 prefer
awplus(config)# ntp peer 192.0.2.23 prefer version 4
awplus(config)# ntp peer 192.0.2.23 prefer version 4 key 1234
awplus(config)# ntp peer 192.0.2.23 version 4 key 1234
awplus(config)# ntp peer 192.0.2.23 version 4
awplus(config)# ntp peer 192.0.2.23 key 1234
```

To remove an NTP peer association for this peer, use the following commands:

```
awplus# configure terminal
awplus(config)# no ntp peer 192.0.2.23
```

ntp server

Use this command to configure an NTP server. This means that this system will synchronize to the other system, and not vice versa.

Use the **no** variant of this command to remove the configured NTP server.

Syntax

```
ntp server {<serveraddress>|<servername>}
ntp server {<serveraddress>|<servername>}
    [prefer] [key <key>] [version <version>]
no ntp server {<serveraddress>|<servername>}
```

Parameter	Description
<serveraddress>	Specify the IP address of the server, entered in the form A.B.C.D.
<servername>	Specify the server hostname.
prefer	Prefer this server when possible.
key <key>	<1-4294967295> Configure the server authentication key.
version <version>	<1-4> Configure for this NTP version.

Mode Global Configuration

Examples See the following commands for options to configure an NTP server association, key and NTP version for the server with an IP address of 192.0.2.23:

```
awplus# configure terminal
awplus(config)# ntp server 192.0.2.23
awplus(config)# ntp server 192.0.2.23 prefer
awplus(config)# ntp server 192.0.2.23 prefer version 4
awplus(config)# ntp server 192.0.2.23 prefer version 4 key 1234
awplus(config)# ntp server 192.0.2.23 version 4 key 1234
awplus(config)# ntp server 192.0.2.23 version 4
awplus(config)# ntp server 192.0.2.23 key 1234
```

To remove an NTP peer association for this peer, use the following commands:

```
awplus# configure terminal
awplus(config)# no ntp server 192.0.2.23
```

ntp trusted-key

This command defines a list of trusted authentication keys. If a key is trusted, this system will be ready to synchronize to a system that uses this key in its NTP packets.

Use the **no** variant of this command to remove a configured trusted authentication key.

Syntax `ntp trusted-key <1-4294967295>`
`no ntp trusted-key <1-4294967295>`

Parameter	Description
<code><1-4294967295></code>	The specific key number.

Mode Global Configuration

Example To define a trusted authentication key numbered 234675, use the following commands:

```
awplus# configure terminal
awplus(config)# ntp trusted-key 234676
```

To remove the trusted authentication key numbered 234675, use the following commands:

```
awplus# configure terminal
awplus(config)# no ntp trusted-key 234676
```

show counter ntp

This command displays packet counters for NTP.

Syntax `show counter ntp`

Mode User Exec and Privileged Exec

Output Figure 74-1: Example output from the `show counter ntp` command

```
NTP counters
Pkts Sent           ..... 0
Pkts Received       ..... 70958
Pkts Processed      ..... 0
Pkts current version ..... 0
Pkts old version     ..... 0
Pkts unknown version ..... 0
Pkts access denied   ..... 70958
Pkts bad length     ..... 0
Pkts bad auth        ..... 0
Pkts rate exceed     ..... 0
```

Table 74-1: Parameters in the output from the `show counter ntp` command

Parameter	Description
Pkts Sent	Total number of NTP client and server packets sent by your device.
Pkts Received	Total number of NTP client and server packets received by your device.
Pkts Processed	The number of packets processed by NTP. NTP processes a packet once it has determined that the packet is valid by checking factors such as the packet's authentication, format, access rights and version.
Pkts current version	The number of version 4 NTP packets received.
Pkts old version	The number of NTP packets received that are from an older version, down to version 1, of NTP. NTP is compatible with these versions and processes these packets.
Pkts unknown version	The number of NTP packets received that are an earlier version than version 1, or a higher version than version 4. NTP cannot process these packets.
Pkts access denied	The number of NTP packets received that do not match any access list statements in the NTP access-groups. NTP drops these packets.
Pkts bad length	The number of NTP packets received that do not conform to the standard packet length. NTP drops these packets.
Pkts bad auth	The number of NTP packets received that failed authentication. NTP drops these packets. Packets can only fail authentication if NTP authentication is enabled with the <code>ntp authenticate</code> command.
Pkts rate exceed	The number of packets dropped because the packet rate exceeded its limits.

Example To display counters for NTP, use the command:

```
awplus# show counter ntp
```

show ntp associations

Use this command to display the status of NTP associations. Use the detail option for displaying detailed information about the associations.

Syntax show ntp associations [detail]

Mode User Exec and Privileged Exec

Example See the sample output of the `show ntp associations` and `show ntp associations detail` commands displaying the status of NTP associations

Figure 74-2: Example output from the `show ntp associations` command

```
awplus#show ntp associations
address      ref clock      st  when  poll reach  delay  offset  disp
~192.0.2.23  INIT          16   -    512  000    0.0    0.0    0.0
* master (syncd), # master (unsyncd), + selected, - candidate, ~ configured
awplus#
```

Figure 74-3: Example output from the `show ntp associations detail` command

```
awplus#show ntp associations detail
192.0.2.23 configured, sane, valid, leap_sub, stratum 16
ref ID INIT, time 00000000.00000000 (06:28:16.000 UTC Thu Feb 7 2036)
our mode client, peer mode unspec, our poll intvl 512, peer poll intvl 1024
root delay 0.00 msec, root disp 0.00, reach 000,
delay 0.00 msec, offset 0.0000 msec, dispersion 0.00
precision 2**-19,
org time 00000000.00000000 (06:28:16.000 UTC Thu Feb 7 2036)
rcv time 00000000.00000000 (06:28:16.000 UTC Thu Feb 7 2036)
xmt time cf11f2a4.cedde5e4 (00:39:00.808 UTC Tue Feb 2 2010)
filtdelay = 0.00 0.00 0.00 0.00 0.00 0.00 0.00 0.00
filtoffset = 0.00 0.00 0.00 0.00 0.00 0.00 0.00 0.00
filterror = 16000.00 16000.00 16000.00 16000.00 16000.00 16000.00 16000.00 16000.00
0 16000.00
```

Table 74-2: Parameters in the output from the `show ntp associations` command

Parameter	Description
address	Peer IP address
ref clock	IP address for reference clock
st	Stratum. The number of hops between the server and the accurate time source.
poll	Time between NTP requests from the device to the server.
reach	Shows whether or not the NTP server responded to the last request.
delay	Round trip delay between the device and the server.
offset	Difference between the device clock and the server clock.
disp	Lowest measure of error associated with peer offset based on delay.

show ntp status

Use this command to display the status of the Network Time Protocol (NTP).

Syntax `show ntp status`

Mode User Exec and Privileged Exec

Example See the sample output of the `show ntp status` command displaying information about the Network Time Protocol.

Figure 74-4: Example output from the `show ntp status` command

```
awplus#sh ntp status
Clock is synchronized, stratum 3, reference is 127.127.1.0
actual frequency is 0.0000 Hz, precision is 2**-19
reference time is cf11f3f2.c7c081a1 (00:44:34.780 UTC Tue Feb  2
2010)
clock offset is 0.000 msec, root delay is 0.000 msec
root dispersion is 7947729.000 msec,
awplus#
```

Chapter 75: Dynamic Host Configuration Protocol (DHCP) Introduction



Introduction.....	75.2
BOOTP.....	75.2
DHCP.....	75.2
DHCP Relay Agents.....	75.2
Configuring the DHCP Server.....	75.3
Create the Pool.....	75.3
Define the Network.....	75.3
Define the Range.....	75.4
Set the Lease.....	75.4
Set the Options.....	75.4
Configuring the DHCP Relay Agent.....	75.6
Configuring the DHCP Relay Agent.....	75.6
DHCP Relay Agent Option 82.....	75.7
Configuring the DHCP Client.....	75.10
Clearing Dynamically Allocated Lease Bindings.....	75.11

Introduction

This chapter describes the Dynamic Host Configuration Protocol (DHCP) support provided by your device. This includes how to configure your device to:

- act as a DHCP and BOOTP server
- act as a DHCP relay agent
- use the DHCP client to obtain IP addresses for its own interfaces

Note that you can configure your device to operate as both a DHCP relay agent and a DHCP/BOOTP server.

BOOTP

Bootstrap Protocol (BOOTP) is a UDP-based protocol that enables a booting host to dynamically configure itself without external interventions. A BOOTP server responds to requests from BOOTP clients for configuration information, such as the IP address the client should use. BOOTP is defined in RFC 951, Bootstrap Protocol (BOOTP).

RFC 1542, Clarifications and Extensions for the Bootstrap Protocol, defines extensions to the BOOTP protocol, including the behavior of a DHCP relay agent.

DHCP

DHCP is widely used to dynamically assign host IP addresses from a centralized server that reduces the overhead of administrating IP addresses. DHCP helps conserve the limited IP address space because IP addresses no longer need to be permanently assigned to hosts. DHCP centrally manages IP address assignment for a large number of subscribers.

DHCP is based on BOOTP, and is defined in RFC 2131. It extends the BOOTP mechanism by providing:

- a method for passing configuration information to hosts on a TCP/IP network
- automatic allocation of reusable network addresses
- other additional configuration options

When your device is configured as a DHCP server, it allocates IP addresses and other IP configuration parameters to clients (hosts), when the client requests them. This lets you configure your IP network without manually configuring every client. Note that each client must also be configured to receive its IP address automatically.

As well as addresses, a DHCP server assigns a wide range of parameters to clients, including subnet information and mask, domain and hostname, server addresses, keepalive times, MTUs, boot settings, encapsulation settings, time settings, and TCP settings.

DHCP is designed to interoperate with BOOTP clients and DHCP clients, without the BOOTP clients needing any change to their initialization software.

DHCP Relay Agents

DHCP relay agents pass BOOTP and DHCP messages between servers and clients. Networks where the DHCP or BOOTP server does not reside on the same IP subnet as its clients need the intermediate routers to act as relay agents. A maximum number of 400 DHCP relay agents (one per interface) can be configured on the device. Once this limit has been reached, any further attempts to configure DHCP relay agents will not be successful.

Configuring the DHCP Server

The DHCP server uses **address pools** when responding to DHCP client requests. Address pools contains specific IP configuration details that the DHCP server can allocate to a client. You can configure multiple address pools on the device for different networks.

To configure a pool, you must:

- For networks where you do not want the server to respond to BOOTP requests, you can configure the DHCP server so that it ignores them, by using the command: and enter its configuration mode.
- Define the Network the pool applies to.
- Define the Range of IP addresses that the server can allocate to clients. You can specify multiple address ranges for each pool.
- Set the Lease for the clients. This defines whether the clients receive a dynamic, permanent, or static IP address.
- Set the Options (standard and user-defined) that the clients of a pool require when configuring their IP details.

After configuring the address pools, you can then enable the DHCP server by using the command:

```
awplus(config)# service dhcp-server
```

For networks where you do not want the server to respond to BOOTP requests, you can configure the DHCP server so that it ignores them, by using the command:

```
awplus(config)# ip dhcp bootp ignore
```

Create the Pool

A DHCP pool is identified by a name. To create a DHCP pool and enter the configuration mode for the pool, use the command:

```
awplus(config)# ip dhcp pool <pool-name>
```

Define the Network

Define the network that the DHCP clients are in. You can define one network per address pool. Use the following command to define the network after defining the DHCP pool first:

```
awplus(dhcp-config)# network
```

- For remote clients, set the network address to the network of the remote clients. The **network** command does not need to match a specific interface's network, because the DHCP server listens on all IP interfaces for DHCP requests.
- For locally connected clients, ensure that the desired interface has an IP address and subnet mask defined; use the **ip address IPADDR** command to set a static address. Enter the configuration mode for the pool, and set the DHCP address pool's network to match the interface's network. Pools that span multiple interfaces are possible only if the interface networks are contiguous.

Define the Range

Configure an IP address range for the pool. This range must be in the same subnet as the pool's network setting. Use the command:

```
awplus(dhcp-config)# range <ip-address> [<ip-address>]
```

The first IPv4 address specifies the **low end of the range**, while the second IP address is the **high end**. You can set the range to a single IP address by specifying only one IP address.

Set the Lease

The DHCP server assigns IP settings to hosts for specific times (the lease time). Each DHCP pool has one lease time setting. You can use DHCP to allocate the following types of addresses:

- A *dynamic* IP addresses
These are available to a host for a limited amount of time. When the lease expires, the server can reallocate the IP address to another device. To set the lease time for the DHCP pool so that it assigns dynamic IP addresses, use the command:

```
awplus(dhcp-config)# lease <days> <hours> <minutes>
```

- A *permanent* IP addresses
These are available to a host for an unlimited amount of time. To set the lease time to assign permanent IP addresses, use the command:

```
awplus(dhcp-config)# lease infinite
```

- A *static* IP addresses
These are allocated to a particular client. The DHCP server recognizes the client by its MAC address. This lets you use DHCP to manage most of your network automatically, while having unchanging IP addresses on key devices such as servers. To assign a static IP address to a device, use the command:

```
awplus(dhcp-config)# host <ip-address> <mac-address>
```

BOOTP requests can be satisfied by pools with leases set to infinity.

Set the Options

DHCP allows clients to receive options from the DHCP server. Options describe the network configuration, and various services that are available on the network. Options are configured separately on each DHCP pool. You can configure both standard predefined options and user-defined options for a DHCP pool.

To create a user-defined option, use the command:

```
awplus(config)# ip dhcp option <1-254> [name <option-name>] [<option-type>]
```

To add a user-defined option to a DHCP address pool, use the command sequence:

```
awplus(config)# ip dhcp pool <pool-name>
```

```
awplus(dhcp-config)# option [<1-254>|<option-name>] <option-value>
```

It is possible to add a user-defined option with the same number as an existing pre-defined option. If this situation occurs, the user-defined option takes precedence—that is, it overrides but does not eliminate the standard option.

You can set some pre-defined options using the following commands:

To set a subnet mask (option 1) for the address pool, use the command:

```
awplus(dhcp-config)# subnet-mask <mask>
```

To add a domain name (option 15) for the address pool, use the command:

```
awplus(dhcp-config)# domain-name <domain-name>
```

To add a default router (option 3) for the address pool, use the command:

```
awplus(dhcp-config)# default-router <ip-address>
```

To add a DNS server (option 6) for the address pool, use the command:

```
awplus(dhcp-config)# dns-server <ip-address>
```

Configuring the DHCP Relay Agent

DHCP relay agents pass BOOTP messages between servers and clients. Networks where the DHCP or BOOTP server does not reside on the same IP subnet as its clients need the routers attached to the subnet to act as DHCP relay agents.

Note that both BOOTP and DHCP use BOOTP messages, allowing DHCP relay agents to relay all their packets.

Your device's DHCP Relay Agent relays these message types:

- BOOTREQUEST messages originating from any of the device's interfaces to a user-defined destination
- BOOTREPLY messages addressed to BOOTP clients on networks directly connected to the device

The relay agent ignores BOOTREPLY messages addressed to clients on networks not directly connected to the device. The device treats these as ordinary IP packets for forwarding.

A BOOTREQUEST message may be relayed via unicast, multicast or broadcast methods. In the last case, the message does not re-broadcast to the interface from which it was received. The relay destinations are configured independently of other broadcast forwarders' destinations (e.g. TFTP).

The hops field in a BOOTP message records the number of hops (routers) the message has been through. If the value of the hops field exceeds a predefined threshold, the relay agent discards the message.

Configuring the DHCP Relay Agent

To enable the DHCP relay agent on your device, use the command:

```
awplus(config)# service dhcp-relay
```

You must define a relay destination on one of the device's interfaces before the relay agent can relay packets. This is the path to the DHCP server. To define a relay destination, use the commands:

```
awplus(config)# interface <ifname>
awplus(config-if)# ip dhcp-relay server-address <ip-address>
```

You can define more than one relay destination on your device. The following table describes how the relay agent forwards the packets.

If an interface has...	Then the relay agent relays BOOTP packets it receives on that interface to...
one relay destination defined	the relay destination.
multiple relay destinations defined	each defined relay destination.

To delete a relay destination, use the command:

```
awplus(dhcp-config)# no ip dhcp-relay server-address <ip-address>
```

When the 'hops' field in a BOOTP message exceeds a predefined threshold the BOOTP message is discarded. The default of the threshold is 10. To set the threshold, use the command:

```
awplus(config-if)# ip dhcp-relay maxhops <1-255>
```

To display the current configuration of the DHCP relay agent, use the command:

```
awplus# show ip dhcp-relay [interface <interface>]
```

DHCP Relay Agent Option 82

Enabling the DHCP option-82 feature on the switch enables the switch to insert extra information into the DHCP packets that it is relaying. This information enables more accurate identification of a subscriber, as it states which switch port on which relay switch the subscriber is connected to. The information is stored in a specific optional field in the DHCP packet, namely, the agent-information field, which has option ID 82.

The DHCP relay agent inserts the option 82 information into the DHCP packets that it is relaying to a DHCP server. DHCP servers that are configured to recognize option 82 may use the information to implement IP addresses, or other parameter assignment policies, based on the network location of the client device. Alternatively, the server can simply log this information to create a detailed audit trail of the locations of the clients to which given addresses were allocated at given times.

When you enable the DHCP relay agent option 82, the following actions happen:

- The DHCP client generates a DHCP request and broadcasts it on the network.
- The DHCP relay agent intercepts the broadcast DHCP request packet and inserts the relay agent information option (option 82) in the packet.
- The DHCP relay agent forwards the DHCP request that includes the option-82 field to the DHCP server.
- The DHCP server receives the packet.
- The DHCP server echoes the option-82 field in the DHCP reply. If the server does not support option 82, it ignores the option and does not echo it in the reply.
- The DHCP server unicasts the reply to the relay agent.
- The relay agent removes the option-82 field and forwards the packet to the switch port that connects to the DHCP client, which sent the DHCP request.

For more information about DHCP Relay Agent Option 82, see RFC 3046. Option 82 can be:

- added to packets relayed from the DHCP client to DHCP server
- removed from packets relayed from DHCP server to DHCP client
- checked from sources closer to the client

To enable the relay agent to insert its details into the option 82 field in requests received from clients attached to a particular interface, use the command:

```
awplus(config)# interface <ifname>
awplus(config-if)# ip dhcp-relay agent-option
```

This applies to requests received with no other agent relay information in the option 82 field.

Note that the Option 82 agent information added by DHCP Relay differs from the information inserted by the DHCP snooping (see [DHCP Option 82 command on page 67.4](#)).

Dealing with client-originated packets that already contain option-82 information

The discussion above deals with the case where the DHCP requests arriving from the clients do not already contain option-82 information. However, it is possible that the requests arriving from the clients to the relay agent could already contain option-82 information. There are two main circumstances in which this can occur:

1. A client is maliciously inserting bogus information into the packet in an attempt to subvert the process of identifying the client's location
2. A layer-2 DHCP snooping switch, that sits between the clients and the DHCP relay, is validly inserting the option-82 information into the packets. The DHCP snooping switch is not acting as a relay agent, so it is not filling in the **giaddr** field (the relay IP address field) in the packet; it is only inserting the option-82 information.

In case 1, you would want to drop the packets that contain the bogus information (or, at least remove the bogus information). In case 2, you would want to forward the valid information to the DHCP server.

To configure the switch to check for the presence of option-82 information in incoming DHCP requests, configure DHCP-relay agent-option checking, with the command (in interface mode):

```
awplus(config)# interface <ifname>
awplus(config-if)# ip dhcp-relay agent-option checking
```

By default, this will cause the switch to act as follows:

- If the incoming DHCP request has a null IP address (0.0.0.0) in the **giaddr** field, and contains option-82 information, drop the packet. This assumes that such a packet has been maliciously created by a client.
- If an incoming DHCP request has a non-null in the **giaddr** field, and contains option-82 information, then replace the option-82 field with the current switch's own information. This assumes that a non-null **giaddr** field indicates that the packet has already passed through a valid DHCP relay device, and so the presence of the option-82 information is not an indication of malicious intent.

The action taken on packets that have a null **giaddr** field and an option-82 field present cannot be altered once the agent-option check has been enabled. But, the action taken on packets with a non-null **giaddr** field and an option-82 field is configurable. The command to configure this action is shown below:

```
awplus(config)# interface <ifname>
awplus(config-if)# ip dhcp-relay information policy
```

This command takes parameters that can configure the switch to:

- Leave the existing option-82 field untouched
- Append its own option-82 field after the existing field
- Drop the packet
- Replace the existing option-82 information with its own (the default).

DHCP Relay Agent Option 82 maximum message length

Where a DHCP relay (that has option 82 insertion enabled) receives a *request* packet from a *DHCP client*, it will append the *option 82* component data, and forward the packet to the DHCP server. The DHCP client will sometimes issue packets containing pad option fields that can be overwritten with *option 82* data. Where there are insufficient pad option fields to contain all the option 82 data, the DHCP relay will increase the packet size to accommodate the option 82 data. If the new (increased) packet size exceeds that defined by the **maximum-message-length** parameter, of the [ip dhcp-relay max-message-length command on page 76.17](#) then the DHCP relay will drop the packet.

```
awplus(config)# interface <ifname>
awplus(config-if)# ip dhcp-relay max-message-length 1200
```

Configuring the DHCP Client

You can configure an interface on your device with a static IP address, or with a dynamic IP address assigned using your device's DHCP client. When you use the DHCP client, it obtains the IP address for the interface, and other IP configuration parameters, from a DHCP server. To configure an interface and gain its IP configuration using the DHCP client, use the command:

```
awplus(config)# interface <ifname>
awplus(config-if)# ip address dhcp [client-id <interface>] [hostname <hostname>]
```

The DHCP client supports the following IP configuration options:

- Option 1 - the subnet mask for your device.
- Option 3 - a list of default routers.
- Option 6 - a list of DNS servers. This list appends the DNS servers set on your device with the `ip name-server` command.
- Option 15 - a domain name used to resolve host names. This option replaces the domain name set with the `ip domain-name` command. Your device ignores this domain name if it has a domain list set using the `ip domain-list` command.
- Option 51 - lease expiration time.

If an IP interface is configured to get its IP address and subnet mask from DHCP, the interface does not take part in IP routing until the IP address and subnet mask have been set by DHCP.

For information on configuring static IP address on an interface, see the [ip address command on page 23.11](#).

Clearing Dynamically Allocated Lease Bindings

A lease binding is the mapping of an IP address to a physical address. To clear dynamically allocated lease bindings, use the command:

```
awplus# clear ip dhcp binding {ip <ip-address>|mac <mac-address>|all|pool  
<pool-name>|range <low-ip-address> <high-ip-address>}
```

You have the option to clear either a specific lease binding, specified by IP or MAC address, or to clear several lease bindings at once. The options for clearing multiple lease bindings are:

- **all**, to clear all DHCP bindings
- **pool**, to clear a specific DHCP server address pool
- **range**, to clear a range of DHCP clients

Chapter 76: Dynamic Host Configuration Protocol (DHCP) Commands

Command List.....	76.2
bootfile	76.2
clear ip dhcp binding.....	76.3
default-router.....	76.4
dns-server	76.5
domain-name.....	76.6
host.....	76.7
ip address dhcp.....	76.8
ip dhcp bootp ignore	76.9
ip dhcp option.....	76.10
ip dhcp pool.....	76.12
ip dhcp-relay agent-option.....	76.13
ip dhcp-relay agent-option checking	76.14
ip dhcp-relay information policy	76.15
ip dhcp-relay maxhops.....	76.16
ip dhcp-relay max-message-length.....	76.17
ip dhcp-relay server-address.....	76.18
lease	76.19
network (DHCP).....	76.20
next-server	76.21
option.....	76.22
range.....	76.24
service dhcp-relay.....	76.25
service dhcp-server	76.26
show counter dhcp-client.....	76.27
show counter dhcp-relay.....	76.28
show counter dhcp-server	76.30
show dhcp lease.....	76.31
show ip dhcp binding.....	76.33
show ip dhcp pool.....	76.34
show ip dhcp-relay	76.37
show ip dhcp server statistics.....	76.38
show ip dhcp server summary.....	76.39
subnet-mask.....	76.40

Command List

This chapter provides an alphabetical reference for commands used to configure DHCP. For more information, see [Chapter 75, Dynamic Host Configuration Protocol \(DHCP\) Introduction](#).

For information about modifying or redirecting the output from **show** commands to a file, see ["Controlling "show" Command Output" on page 1.35](#).

bootfile

This command sets the boot filename for a DHCP server pool. This is the name of the boot file that the client should use in its bootstrap process. It may need to include a path.

The **no** variant of this command removes the boot filename from a DHCP server pool.

Syntax `bootfile <filename>`
`no bootfile`

Parameter	Description
<code><filename></code>	The boot file name.

Mode DHCP Configuration

Example To configure the boot filename for a pool P2, use the command:

```
awplus# configure terminal
awplus(config)# ip dhcp pool P2
awplus(dhcp-config)# bootfile boot/main_boot.bt
```

clear ip dhcp binding

This command clears either a specific lease binding or the lease bindings specified by the command. The command will only take effect on dynamically allocated bindings, not statically configured bindings.

Syntax `clear ip dhcp binding {ip <ip-address>|mac <mac-address>|all|pool <pool-name>|range <low-ip-address> <high-ip-address>}`

Parameter	Description
<code>ip <ip-address></code>	IPv4 address of the DHCP client, in dotted decimal notation in the format A.B.C.D.
<code>mac <mac-address></code>	MAC address of the DHCP client, in hexadecimal notation in the format HHHH.HHHH.HHHH.
<code>all</code>	All DHCP bindings.
<code>pool <pool-name></code>	Description used to identify DHCP server address pool. Valid characters are any printable character. If the name contains spaces then you must enclose these in "quotation marks".
<code>range <low-ip-address> <high-ip-address></code>	IPv4 address range for DHCP clients, in dotted decimal notation. The first IP address is the low end of the range, the second IP address is the high end of the range.

Mode User Exec and Privileged Exec

Usage A specific binding may be deleted by **ip** address or **mac** address, or several bindings may be deleted at once using **all**, **pool** or **range**.

Note that if you specify to clear the **ip** or **mac** address of what is actually a static DHCP binding, an error message is displayed. If **all**, **pool** or **range** are specified and one or more static DHCP bindings exist within those addresses, any dynamic entries within those addresses are cleared but any static entries are not cleared.

Examples To clear the specific IP address binding 192.168.1.1, use the command:

```
awplus# clear ip dhcp binding ip 192.168.1.1
```

To clear all dynamic DHCP entries, use the command:

```
awplus# clear ip dhcp binding all
```

Related Commands [show ip dhcp binding](#)

default-router

This command adds a default router to the DHCP address pool you are configuring. You can use this command multiple times to create a list of default routers on the client's subnet. This sets the router details using the pre-defined option 3. Note that if you add a user-defined option 3 using the **option** command, then you will override any settings created with this command.

The **no** variant of this command removes either the specified default router, or all default routers from the DHCP pool.

Syntax `default-router <ip-address>`
`no default-router [<ip-address>]`

Parameter	Description
<code><ip-address></code>	IPv4 address of the default router, in dotted decimal notation.

Mode DHCP Configuration

Examples To add a router with an IP address 192.168.1.2 to the DHCP pool named P2, use the following commands:

```
awplus# configure terminal
awplus(config)# ip dhcp pool P2
awplus(dhcp-config)# default-router 192.168.1.2
```

To remove a router with an IP address 192.168.1.2 to the DHCP pool named P2, use the following commands:

```
awplus# configure terminal
awplus(config)# ip dhcp pool P2
awplus(dhcp-config)# no default-router 192.168.1.2
```

To remove all routers from the DHCP pool named P2, use the following commands:

```
awplus# configure terminal
awplus(config)# ip dhcp pool P2
awplus(dhcp-config)# no default-router
```

dns-server

This command adds a Domain Name System (DNS) server to the DHCP address pool you are configuring. You can use this command multiple times to create a list of DNS name servers available to the client. This sets the DNS server details using the pre-defined option 6. Note that if you add a user-defined option 6 using the [option command on page 76.22](#), command, then you will override any settings created with this command.

The **no** variant of this command removes either the specified DNS server, or all DNS servers from the DHCP pool.

Syntax `dns-server <ip-address>`
`no dns-server [<ip-address>]`

Parameter	Description
<code><ip-address></code>	IPv4 address of the DNS server, in dotted decimal notation.

Mode DHCP Configuration

Examples To add the DNS server with the assigned IP address 192.168.1.1 to the DHCP pool named P1, use the following commands:

```
awplus# configure terminal
awplus(config)# ip dhcp pool P2
awplus(dhcp-config)# dns-server 192.168.1.1
```

To remove the DNS server with the assigned IP address 192.168.1.1 from the DHCP pool named P1, use the following commands:

```
awplus# configure terminal
awplus(config)# ip dhcp pool P2
awplus(dhcp-config)# no dns-server 192.168.1.1
```

To remove all DNS servers from the DHCP pool named P1, use the following commands:

```
awplus# configure terminal
awplus(config)# ip dhcp pool P2
awplus(dhcp-config)# no dns-server
```

Related Commands [default-router](#)
[option](#)
[service dhcp-server](#)
[show ip dhcp pool](#)
[subnet-mask](#)

domain-name

This command adds a domain name to the DHCP address pool you are configuring. Use this command to specify the domain name that a client should use when resolving host names using the Domain Name System. This sets the domain name details using the pre-defined option 15. Note that if you add a user-defined option 15 using the [option command on page 76.22](#), then you will override any settings created with this command.

The **no** variant of this command removes the domain name from the address pool.

Syntax `domain-name <domain-name>`

`no domain-name`

Parameter	Description
<code><domain-name></code>	The domain name you wish to assign the DHCP pool. Valid characters are any printable character. If the name contains spaces then you must enclose it in "quotation marks".

Mode DHCP Configuration

Examples To add the domain name `Nerv_Office` to DHCP pool `P2`, use the commands:

```
awplus# configure terminal
awplus(config)# ip dhcp pool P2
awplus(dhcp-config)# domain-name Nerv_Office
```

To remove the domain name `Nerv_Office` from DHCP pool `P2`, use the commands:

```
awplus# configure terminal
awplus(config)# ip dhcp pool P2
awplus(dhcp-config)# no domain-name Nerv_Office
```

Related Commands

- [default-router](#)
- [dns-server](#)
- [option](#)
- [service dhcp-server](#)
- [show ip dhcp pool](#)
- [subnet-mask](#)

host

This command adds a static host address to the DHCP address pool you are configuring. The client with the matching MAC address is permanently assigned this IP address. No other clients can request it.

The **no** variant of this command removes the specified host address from the DHCP pool. Use the **no host all** command to remove all static host addresses from the DHCP pool.

Syntax `host <ip-address> <mac-address>`
`no host <ip-address>`
`no host all`

Parameter	Description
<code><ip-address></code>	IPv4 address of the DHCP client, in dotted decimal notation in the format A.B.C.D
<code><mac-address></code>	MAC address of the DHCP client, in hexadecimal notation in the format HHHH.HHHH.HHHH

Mode DHCP Configuration

Usage Note that a network/mask must be configured using a **network** command before issuing a **host** command. Also note that a host address must match a network to add a static host address.

Examples To add the host at 192.168.1.5 with the MAC address 000a.451d.6e34 to DHCP pool 1, use the commands:

```
awplus# configure terminal
awplus(config)# ip dhcp pool 1
awplus(dhcp-config)# network 192.168.1.0/24
awplus(dhcp-config)# host 192.168.1.5 000a.451d.6e34
```

To remove the host at 192.168.1.5 with the MAC address 000a.451d.6e34 from DHCP pool 1, use the commands:

```
awplus# configure terminal
awplus(config)# ip dhcp pool 1
awplus(dhcp-config)# no host 192.168.1.5 000a.451d.6e34
```

Related Commands `lease`
`range`
`show ip dhcp pool`

ip address dhcp

This command activates the DHCP client on the interface you are configuring. This allows the interface to use the DHCP client to obtain its IP configuration details from a DHCP server on its connected network.

The **client-id** and **hostname** parameters are identifiers that you may want to set in order to interoperate with your existing DHCP infrastructure. If neither option is needed, then the DHCP server uses the MAC address field of the request to identify the host.

The DHCP client supports the following IP configuration options:

- Option 1 - the subnet mask for your device.
- Option 3 - a list of default routers.
- Option 6 - a list of DNS servers. This list appends the DNS servers set on your device with the **ip name-server** command.
- Option 15 - a domain name used to resolve host names. This option replaces the domain name set with the **ip domain-name** command. Your device ignores this domain name if it has a domain list set using the **ip domain-list** command.
- Option 51 - lease expiration time.

The **no** variant of this command stops the interface from obtaining IP configuration details from a DHCP server.

Syntax `ip address dhcp [client-id <interface>] [hostname <hostname>]`
`no ip address dhcp`

Parameter	Description
<code><interface></code>	The name of the interface you are activating the DHCP client on. If you specify this, then the MAC address associated with the specified interface is sent to the DHCP server in the optional identifier field. Default: no default
<code><hostname></code>	The hostname for the DHCP client on this interface. Typically this name is provided by the ISP. Default: no default

Mode Interface Configuration for a VLAN interface.

Examples To set the interface `vlan10` to use DHCP to obtain an IP address, use the command:

```
awplus# configure terminal
awplus(config)# interface vlan10
awplus(config-if)# ip address dhcp
```

To stop the interface `vlan10` from using DHCP to obtain its IP address, use the command:

```
awplus# configure terminal
awplus(config)# interface vlan10
awplus(config-if)# no ip address dhcp
```

Related Commands [ip address](#)

Validation Commands [show running-config](#)
[show running-config access-list](#)

ip dhcp bootp ignore

This command configures the DHCP server to ignore any BOOTP requests it receives. The DHCP server accepts BOOTP requests by default.

The **no** variant of this command configures the DHCP server to accept BOOTP requests. This is the default setting.

Syntax `ip dhcp bootp ignore`
`no ip dhcp bootp ignore`

Mode Global Configuration

Examples To configure the DHCP server to ignore BOOTP requests, use the command:

```
awplus# configure terminal
awplus(config)# ip dhcp bootp ignore
```

To configure the DHCP server to respond to BOOTP requests, use the command:

```
awplus# configure terminal
awplus(config)# no ip dhcp bootp ignore
```

Related Commands [show ip dhcp server summary](#)

ip dhcp option

This command creates a user-defined DHCP option. You can then use this option when configuring a DHCP pool, by using the `option` command. Options with the same number as one of the pre-defined options override the standard option definition. The pre-defined options use the option numbers 1, 3, 6, 15, and 51.

The `no` variant of this command removes either the specified user-defined option, or removes all user-defined options. This also automatically removes the user-defined options from the associated DHCP address pools.

Syntax `ip dhcp option <1-254> [name <option-name>] [<option-type>]`
`no ip dhcp option [<1-254>|<option-name>]`

Parameter	Description										
<code><1-254></code>	The option number of the option. Options with the same number as one of the standard options overrides the standard option definition.										
<code><option-name></code>	Option name used to identify the option. You cannot use a number as the option name. Valid characters are any printable character. If the name contains spaces then you must enclose it in "quotation marks". Default: no default										
<code><option-type></code>	The option value. You must specify a value that is appropriate to the option type: <table border="1"> <tbody> <tr> <td><code>ascii</code></td> <td>An ASCII text string</td> </tr> <tr> <td><code>hex</code></td> <td>A hexadecimal string. Valid characters are the numbers 0–9 and letters a–f. Embedded spaces are not valid. The string must be an even number of characters, from 2 and 256 characters long.</td> </tr> <tr> <td><code>ip</code></td> <td>An IPv4 address or mask that has the dotted decimal A.B.C.D notation. To create a list of IP addresses, you must add each IP address individually by using the option command multiple times.</td> </tr> <tr> <td><code>integer</code></td> <td>A number from 0 to 4294967295.</td> </tr> <tr> <td><code>flag</code></td> <td>A value that either sets (to 1) or unsets (to 0) a flag: true, on, or enabled will set the flag false, off or disabled will unset the flag.</td> </tr> </tbody> </table>	<code>ascii</code>	An ASCII text string	<code>hex</code>	A hexadecimal string. Valid characters are the numbers 0–9 and letters a–f. Embedded spaces are not valid. The string must be an even number of characters, from 2 and 256 characters long.	<code>ip</code>	An IPv4 address or mask that has the dotted decimal A.B.C.D notation. To create a list of IP addresses, you must add each IP address individually by using the option command multiple times.	<code>integer</code>	A number from 0 to 4294967295.	<code>flag</code>	A value that either sets (to 1) or unsets (to 0) a flag: true , on , or enabled will set the flag false , off or disabled will unset the flag.
<code>ascii</code>	An ASCII text string										
<code>hex</code>	A hexadecimal string. Valid characters are the numbers 0–9 and letters a–f. Embedded spaces are not valid. The string must be an even number of characters, from 2 and 256 characters long.										
<code>ip</code>	An IPv4 address or mask that has the dotted decimal A.B.C.D notation. To create a list of IP addresses, you must add each IP address individually by using the option command multiple times.										
<code>integer</code>	A number from 0 to 4294967295.										
<code>flag</code>	A value that either sets (to 1) or unsets (to 0) a flag: true , on , or enabled will set the flag false , off or disabled will unset the flag.										

Mode Global Configuration

Examples To define a user-defined ASCII string option as option 66, without a name, use the command:

```
awplus# configure terminal
awplus(config)# ip dhcp option 66 ascii
```

To define a user-defined hexadecimal string option as option 46, with the name "tcpip-node-type", use the command:

```
awplus# configure terminal
awplus(config)# ip dhcp option 46 name tcpip-node-type hex
```

To define a user-defined IP address option as option 175, with the name special-address, use the command:

```
awplus# configure terminal
awplus(config)# ip dhcp option 175 name special-address ip
```

To remove the specific user-defined option with the option number 12, use the command:

```
awplus# configure terminal
awplus(config)# no ip dhcp option 12
```

To remove the specific user-defined option with the option name perform-router-discovery, use the command:

```
awplus# configure terminal
awplus(config)# no ip dhcp option perform-router-discovery
```

To remove all user-defined option definitions, use the command:

```
awplus# configure terminal
awplus(config)# no ip dhcp option
```

Related Commands

- default-router
- dns-server
- domain-name
- option
- service dhcp-server
- show ip dhcp server summary
- subnet-mask

ip dhcp pool

This command will enter the configuration mode for the pool name specified. If the name specified is not associated with an existing pool, the switch will create a new pool with this name, then enter the configuration mode for the new pool.

Once you have entered the DHCP configuration mode, all commands executed before the next **exit** command will apply to this pool.

You can create multiple DHCP pools on devices with multiple interfaces. This allows the device to act as a DHCP server on multiple interfaces to distribute different information to clients on the different networks.

The **no** variant of this command deletes the specific DHCP pool.

Syntax `ip dhcp pool <pool-name>`
`no ip dhcp pool <pool-name>`

Parameter	Description
<code><pool-name></code>	Description used to identify this DHCP pool. Valid characters are any printable character. If the name contains spaces then you must enclose it in "quotation marks".

Mode Global Configuration

Example To create the DHCP pool called P2, use the command:

```
awplus# configure terminal
awplus(config)# ip dhcp pool P2
```

Related Commands [service dhcp-server](#)

ip dhcp-relay agent-option

This command enables the DHCP relay agent to insert the relay agent information option (*option 82*) into the client-request packets that it relays to its DHCP server. This allows the relay agent to pass on information to the server about the network location of the client device. The relay agent then strips the *option 82* field out of the server's response, so that the client never sees this field.

When the relay agent appends its option 82 data into the packet, it first overwrites any pad options present; then if necessary, it increases the packet length to accommodate the option 82 data.

The **no** variant of this command stops the relay agent from appending the *option 82* field onto DHCP requests before forwarding it to the server.

Syntax `ip dhcp-relay agent-option`
`no ip dhcp-relay agent-option`

Default The DHCP relay agent feature is disabled by default.

Mode Interface Configuration for a VLAN interface.

Usage Use this command to alter the relay agent's *option 82* setting when your device is the first hop for the DHCP client. To limit the maximum length of the packet, use the [ip dhcp-relay max-message-length command on page 76.17](#).

This command cannot be enabled if DHCP snooping is enabled ([service dhcp-snooping command on page 68.21](#)), and vice versa.

Examples To make the relay agent listening on `vlan15` append the option 82 field, use the commands:

```
awplus# configure terminal
awplus(config)# interface vlan15
awplus(config-if)# ip dhcp-relay agent-option
```

To stop the relay agent from appending the option 82 field on `vlan15`, use the commands:

```
awplus# configure terminal
awplus(config)# interface vlan15
awplus(config-if)# no ip dhcp-relay agent-option
```

Related Commands [ip dhcp-relay information policy](#)
[ip dhcp-relay max-message-length](#)
[service dhcp-relay](#)

ip dhcp-relay agent-option checking

This command controls the way that the DHCP-relay service deals with packets arriving from the client side that have:

- option-82 information present in the packet
- a **giaddr** field (relay agent IP address field) of 0.0.0.0

By default such packets are accepted and passed through. This assumes that the option-82 field has been inserted into the packet by a trusted device, such as a layer-2 DHCP-snooping switch.

However, if you do not have such a trusted device between the relay switch and the clients, then packets arriving with no relay address but containing option-82 information are treated with suspicion and dropped.

The command **ip dhcp-relay agent-option checking** will cause such packets to be dropped. Packets which contain option-82 information, but have a non-zero address in the **giaddr** field will continue to be forwarded.

The **no** variant of this command returns this feature to the default state, whereby the DHCP-relay service does not check the state of the **giaddr** field in packets that contain option-82 information.

Note  The DHCP-relay service might also alter the content of the option-82 field, if the commands **ip dhcp-relay agent-option** and **ip dhcp-relay information policy** have also been configured.

Syntax `ip dhcp-relay agent-option checking`
`no ip dhcp-relay agent-option checking`

Mode Interface Configuration for a VLAN interface.

Examples To make the relay agent listening on `vlan10` check the Agent ID suboption field, use the commands:

```
awplus# configure terminal
awplus(config)# interface vlan10
awplus(config-if)# ip dhcp-relay agent-option checking
```

To stop the relay agent on `vlan10` from checking the Agent ID suboption field, use the commands:

```
awplus# configure terminal
awplus(config)# interface vlan10
awplus(config-if)# no ip dhcp-relay agent-option checking
```

Related Commands [service dhcp-relay](#)

ip dhcp-relay information policy

This command sets the policy for how the DHCP relay deals with packets arriving from the client that contain option-82 information.

If the command **ip dhcp-relay agent-option** has not been configured, then this command has no effect at all - no alteration is made to option-82 information in packets arriving from the client side.

However, if the command **ip dhcp-relay agent-option** has been configured, this command modifies how the DHCP relay service deals with cases where the packet arriving from the client side already contains option-82 information.

By default, the relay agent replaces any existing option-82 field with its own relay agent field. This is equivalent to the functionality of the **replace** parameter.

The **no** variant of this command removes the policy, and returns it to the default behavior - i.e. replacing the existing option-82 field.

Syntax `ip dhcp-relay information policy [append|drop|keep|replace]`
`no ip dhcp-relay information policy`

Parameter	Description
append	The relay agent appends the option 82 field of the packet with its own option 82 details.
drop	The relay agent discards the packet.
keep	The relay agent forwards the packet without altering the option 82 field.
replace	The relay agent replaces the existing relay agent details in the option 82 field with its own details before forwarding the packet.

Mode Interface Configuration for a VLAN interface.

Examples To make the relay agent listening on `vlan15` drop any client requests that already contain option-82 information, use the command:

```
awplus(config)# interface vlan15
awplus(config-if)# ip dhcp-relay information policy drop
```

To remove the DHCP relay information policy set with the **ip dhcp information policy** command, use the command:

```
awplus(config)# interface vlan15
awplus(config-if)# no ip dhcp-relay information policy
```

Related Commands [ip dhcp-relay agent-option](#)
[service dhcp-server](#)

ip dhcp-relay maxhops

This command sets the hop count threshold for discarding BOOTP messages. When the hops field in a BOOTP message exceeds the threshold, the relay agent discards the BOOTP message. The hop count threshold is set to 10 hops by default.

Use the **no** variant of this command negation command to reset the hop count to the default.

Syntax `ip dhcp-relay maxhops <1-255>`
`no ip dhcp-relay maxhops`

Parameter	Description
<1-255>	The maximum hop count value.

Default The default hop count threshold is 10 hops.

Mode Interface Configuration for a VLAN interface.

Example To set the maximum number of hops to 5 for packets arriving in interface `vlan15`, use the command:

```
awplus(config)# interface vlan15
awplus(config-if)# ip dhcp-relay maxhops 5
```

Related Commands [service dhcp-relay](#)

ip dhcp-relay max-message-length

This command applies when the switch is acting as a *DHCP relay* and Option 82 insertion is enabled. It sets the maximum DHCP message length (in bytes) for the DHCP packet with its option 82 data inserted. From this value it calculates the maximum packet size that it will accept at its input. Packets that arrive greater than this value will be dropped.

The **no** variant of this command sets the maximum message length to its default of 1400 bytes.

Syntax `ip dhcp-relay max-message-length <548-1472>`

Parameter	Description
<548-1472>	The maximum DHCP message length (this is the message header plus the inserted DHCP option fields).

Default The default is 1400 bytes.

Mode Interface Configuration for a VLAN interface.

Usage Where a DHCP relay (that has option 82 insertion enabled) receives a *request* packet from a *DHCP client*, it will append the *option 82* component data, and forward the packet to the DHCP server. The DHCP client will sometimes issue packets containing pad option fields that can be overwritten with *option 82* data. Where there are insufficient pad option fields to contain all the option 82 data, the DHCP relay will increase the packet size to accommodate the option 82 data. If the new (increased) packet size exceeds that defined by the **maximum-message-length** parameter, then the DHCP relay will drop the packet.

Note  Before setting this command, you must first run the [ip dhcp-relay agent-option command on page 76.13](#). This will allow the option 82 fields to be appended.

Example To set the maximum DHCP message length to 1200 for packets arriving in interface `vlan7`, use the command:

```
awplus# configure terminal
awplus(config)# interface vlan7
awplus(config-if)# ip dhcp-relay max-message-length 1200
```

Related Commands [service dhcp-relay](#)

ip dhcp-relay server-address

This command adds a server for DHCP relay to forward client DHCP packets to on a particular interface. You can add up to five servers on each interface that the DHCP relay agent is listening on.

The **no** variant of this command deletes the specified DHCP server from the list of servers available to the DHCP relay agent.

Syntax `ip dhcp-relay server-address <ip-address>`
`no ip dhcp-relay server-address <ip-address>`

Parameter	Description
<code><ip-address></code>	IPv4 address of the DHCP server, in dotted decimal notation.

Mode Interface Configuration for a VLAN interface.

Examples To add a DHCP server 192.0.2.200 to forward to on the interface `vlan100`, use the commands:

```
awplus# configure terminal
awplus(config)# interface vlan100
awplus(config-if)# ip dhcp-relay server-address 192.0.2.200
```

To delete the DHCP server 192.0.2.200 from the list of servers available to the DHCP relay agent on `vlan100`, use the commands:

```
awplus# configure terminal
awplus(config)# interface vlan100
awplus(config-if)# no ip dhcp-relay server-address 192.0.2.200
```

Related Commands [service dhcp-relay](#)

lease

This command sets the expiration time for a leased address for the DHCP address pool you are configuring. The time set by the days, hours, and minutes is cumulative.

The lease details use the pre-defined option 51. Note that if you add a user-defined option 51 using the **option** command, then you will override any settings created with this command.

Use the **infinite** parameter to set the lease expiry time to infinite (leases never expire).

Use the **no** variant of this command to return the lease expiration time back to the default of one day.

Syntax `lease <days> <hours> <minutes>`

`lease infinite`

`no lease`

Parameter	Description
<code><days></code>	The number of days, from 0 to 30, that the lease expiry time is configured. Default: 1
<code><hours></code>	The number of hours, from 0 to 24, that the lease expiry time is configured. Default: 0
<code><minutes></code>	The number of minutes, from 0 to 60, the lease expiry time is configured. Default: 0
<code>infinite</code>	The lease never expires.

Default The default lease time is 1 day.

Mode DHCP Configuration

Examples To set the lease expiration time for address pool P2 to 35 minutes, use the commands:

```
awplus# configure terminal
awplus(config)# ip dhcp pool P2
awplus(dhcp-config)# lease 0 0 35
```

To set the lease expiration time for the address pool Nerv_Office to 1 day, 5 hours, and 30 minutes, use the commands:

```
awplus# configure terminal
awplus(config)# ip dhcp pool Nerv_Office
awplus(dhcp-config)# lease 1 5 30
```

To set the lease expiration time for the pool to never expire, use the command:

```
awplus(dhcp-config)# lease infinite
```

To return the lease expiration time to the default of one day, use the command:

```
awplus(dhcp-config)# no lease
```

Related Commands [service dhcp-server](#)

network (DHCP)

This command sets the network (subnet) that the DHCP address pool applies to.

The **no** variant of this command removes the network (subnet) from the DHCP address pool.

Syntax `network {<ip-subnet-address/prefix-length>|<ip-subnet-address/mask>}`
`no network`

Parameter	Description
<code><ip-subnet-address/prefix-length></code>	The IPv4 subnet address in dotted decimal notation followed by the prefix length in slash notation.
<code><ip-subnet-address/mask></code>	The IPv4 subnet address in dotted decimal notation followed by the subnet mask in dotted decimal notation.

Mode DHCP Configuration

Usage This command will fail if it would make existing ranges invalid. For example, if they do not lie within the new network you are configuring.

The **no** variant of this command will fail if ranges still exist in the pool. You must remove all ranges in the pool before issuing a **no network** command to remove a network from the pool.

Examples To configure a network for the address pool P2, where the subnet is 192.0.2.5 and the mask is 255.255.255.0, use the commands:

```
awplus# configure terminal
awplus(config)# ip dhcp pool P2
awplus(dhcp-config)# network 192.0.2.5/24
```

or you can use dotted decimal notation instead of slash notation for the subnet-mask:

```
awplus# configure terminal
awplus(config)# ip dhcp pool P2
awplus(dhcp-config)# network 192.0.2.5 255.255.255.0
```

Related Commands [service dhcp-server](#)
[subnet-mask](#)

next-server

This command sets the next server address for a DHCP server pool. It is the address of the next server that the client should use in its bootstrap process.

The **no** variant of this command removes the next server address from the DHCP address pool.

Syntax `next-server <ip-address>`
`no next-server`

Parameter	Description
<code><ip-address></code>	The server IP address, entered in dotted decimal notation.

Mode DHCP Configuration

Example To set the next-server address for the address pool P2, use the commands:

```
awplus# configure terminal
awplus(config)# ip dhcp pool P2
awplus(dhcp-config)# next-server 192.0.2.2
```

option

This command adds a user-defined option to the DHCP address pool you are configuring. For the **hex**, **integer**, and **flag** option types, if the option already exists, the new option overwrites the existing option's value. Options with an **ip** type can hold a list of IP addresses or masks (i.e. entries that have the A.B.C.D address format), so if the option already exists in the pool, then the new IP address is added to the list of existing IP addresses.

Options with the same number as one of the pre-defined options override the standard option definition. The pre-defined options use the option numbers 1, 3, 6, 15, and 51.

The **no** variant of this command removes the specified user-defined option from the DHCP pool, or all user-defined options from the DHCP pool.

Syntax `option [<1-254>|<option-name>] <option-value>`
`no option [<1-254>|<option-value>]`

Parameter	Description								
<1-254>	The option number of the option. Options with the same number as one of the standard options overrides the standard option definition.								
<option-name>	Option name associated with the option.								
<option-value>	The option value. You must specify a value that is appropriate to the option type: <table border="1"> <tbody> <tr> <td>hex</td> <td>A hexadecimal string. Valid characters are the numbers 0–9 and letters a–f. Embedded spaces are not valid. The string must be an even number of characters, from 2 and 256 characters long.</td> </tr> <tr> <td>ip</td> <td>An IPv4 address or mask that has the dotted decimal A.B.C.D notation. To create a list of IP addresses, you must add each IP address individually using the option command multiple times.</td> </tr> <tr> <td>integer</td> <td>A number from 0 to 4294967295.</td> </tr> <tr> <td>flag</td> <td>A value of either true, on, or enabled to set the flag, or false, off or disabled to unset the flag.</td> </tr> </tbody> </table>	hex	A hexadecimal string. Valid characters are the numbers 0–9 and letters a–f. Embedded spaces are not valid. The string must be an even number of characters, from 2 and 256 characters long.	ip	An IPv4 address or mask that has the dotted decimal A.B.C.D notation. To create a list of IP addresses, you must add each IP address individually using the option command multiple times.	integer	A number from 0 to 4294967295.	flag	A value of either true, on, or enabled to set the flag, or false, off or disabled to unset the flag.
hex	A hexadecimal string. Valid characters are the numbers 0–9 and letters a–f. Embedded spaces are not valid. The string must be an even number of characters, from 2 and 256 characters long.								
ip	An IPv4 address or mask that has the dotted decimal A.B.C.D notation. To create a list of IP addresses, you must add each IP address individually using the option command multiple times.								
integer	A number from 0 to 4294967295.								
flag	A value of either true, on, or enabled to set the flag, or false, off or disabled to unset the flag.								

Mode DHCP Configuration

Examples To add the ASCII-type option named `tftp-server-name` to the pool `P2` and give the option the value `server1`, use the commands:

```
awplus# configure terminal
awplus(config)# ip dhcp pool P2
awplus(dhcp-config)# option tftp-server-name server1
```

To add the hex-type option named `tcpip-node-type` to the pool `P2` and give the option the value `08af`, use the commands:

```
awplus# configure terminal
awplus(config)# ip dhcp pool P2
awplus(dhcp-config)# option tcpip-node-type 08af
```

To add multiple IP addresses for the ip-type option 175, use the command:

```
awplus(dhcp-config)# option 175 192.0.2.6
awplus(dhcp-config)# option 175 192.0.2.12
awplus(dhcp-config)# option 175 192.0.2.33
```

To add the option 179 to a pool, and give the option the value 123456, use the command:

```
awplus(dhcp-config)# option 179 123456
```

To add a user-defined flag option with the name `perform-router-discovery`, use the command:

```
awplus(dhcp-config)# option perform-router-discovery yes
```

To clear all user-defined options from a DHCP address pool, use the command:

```
awplus(dhcp-config)# no option
```

To clear a user-defined option, named `tftp-server-name`, use the command:

```
awplus(dhcp-config)# no option tftp-server-name
```

Related Commands [ip dhcp option](#)
[service dhcp-server](#)
[show ip dhcp pool](#)

range

This command adds an address range to the DHCP address pool you are configuring. The DHCP server responds to client requests received from the pool's network. It assigns an IP addresses within the specified range. The IP address range must lie within the network. You can add multiple address ranges and individual IP addresses for a DHCP pool by using this command multiple times.

The **no** variant of this command removes an address range from the DHCP pool. Use the **no range all** command to remove all address ranges from the DHCP pool.

Syntax

```
range <ip-address> [<ip-address>]
no range <ip-address> [<ip-address>]
no range all
```

Parameter	Description
<ip-address>	IPv4 address range for DHCP clients, in dotted decimal notation. The first IP address is the low end of the range, the second IP address is the high end. Specify only one IP address to add an individual IP address to the address pool.

Mode DHCP Configuration

Examples To add an address range of 192.0.2.5 to 192.0.2.16 to the pool `Nerv_Office`, use the command:

```
awplus# configure terminal
awplus(config)# ip dhcp pool Nerv_Office
awplus(dhcp-config)# range 192.0.2.5 192.0.2.16
```

To add the individual IP address 192.0.2.2 to a pool, use the command:

```
awplus(dhcp-config)# range 192.0.2.2
```

To remove all address ranges from a pool, use the command:

```
awplus(dhcp-config)# no range all
```

Related Commands

- [ip dhcp pool](#)
- [service dhcp-server](#)
- [show ip dhcp pool](#)

service dhcp-relay

This command enables the DHCP relay agent on the device. However, on a given IP interface, no DHCP forwarding takes place until at least one DHCP server is specified to forward/relay all clients' DHCP packets to.

The **no** variant of this command disables the DHCP relay agent on the device for all interfaces.

A maximum number of 400 DHCP relay agents (one per interface) can be configured on the device. Once this limit has been reached, any further attempts to configure DHCP relay agents will not be successful.

Syntax `service dhcp-relay`
`no service dhcp-relay`

Mode Global Configuration

Default The DHCP-relay service is enabled by default.

Examples To enable the DHCP relay global function, use the command:

```
awplus# configure terminal
awplus(config)# service dhcp-relay
```

To disable the DHCP relay global function, use the command:

```
awplus# configure terminal
awplus(config)# no service dhcp-relay
```

Related Commands [ip dhcp-relay agent-option](#)
[ip dhcp-relay agent-option checking](#)
[ip dhcp-relay information policy](#)
[ip dhcp-relay maxhops](#)
[ip dhcp-relay server-address](#)

service dhcp-server

This command enables the DHCP server on your device. The server then listens for DHCP requests on all IP interfaces. It will not run if there are no IP interfaces configured.

The **no** variant of this command disables the DHCP server.

Syntax `service dhcp-server`
`no service dhcp-server`

Mode Global Configuration

Example To enable the DHCP server, use the command:

```
awplus# configure terminal
awplus(config)# service dhcp-server
```

Related Commands `ip dhcp pool`
`show ip dhcp server summary`
`subnet-mask`

show counter dhcp-client

This command shows counters for the dhcp client on your device.

For information on output options, see “Controlling “show” Command Output” on page 1.35.

Syntax show counter dhcp-client

Mode User Exec and Privileged Exec

Example To display the message counters for the DHCP client on your device, use the command:

```
awplus# show counter dhcp-client
```

Output Figure 76-1: Example output from the **show counter dhcp-client** command

```
show counter dhcp-client

DHCPDISCOVER out      ..... 10
DHCPPREQUEST out     ..... 34
DHCPEDECLINE out     ..... 4
DHCPRELEASE out      ..... 0
DHCPOFFER in         ..... 22
DHCPACK in           ..... 18
DHCPNAK in           ..... 0
```

Table 76-1: Parameters in the output of the **show counter dhcp-client** command

Parameter	Description
DHCPDISCOVER out	The number of DHCP Discover messages sent by the client.
DHCPPREQUEST out	The number of DHCP Request messages sent by the client.
DHCPEDECLINE out	The number of DHCP Decline messages sent by the client.
DHCPRELEASE out	The number of DHCP Release messages sent by the client.
DHCPOFFER in	The number of DHCP Offer messages received by the client.
DHCPACK in	The number of DHCP Acknowledgement messages received by the client.
DHCPNAK in	The number of DHCP Negative Acknowledgement messages received by the client.

Related Commands ip address dhcp

show counter dhcp-relay

This command shows counters for the DHCP relay agent on your device.

For information on output options, see [“Controlling “show” Command Output” on page 1.35.](#)

Syntax show counter dhcp-relay

Mode User Exec and Privileged Exec

Example To display counters for the DHCP relay agent on your device, use the command:

```
awplus# show counter dhcp-relay
```

Output Figure 76-2: Example output from the `show counter dhcp-relay` command

```
show counter dhcp-relay

Requests In           ..... 4
Replies In           ..... 4
Relayed To Server    ..... 4
Relayed To Client    ..... 4
Out To Server Failed ..... 0
Out To Client Failed ..... 0
Invalid hlen         ..... 0
Bogus giaddr         ..... 0
Corrupt Agent Option ..... 0
Missing Agent Option ..... 0
Bad Circuit ID       ..... 0
Missing Circuit ID   ..... 0
Option Insert Failed ..... 0
```

Table 76-2: Parameters in the output of the `show counter dhcp-relay` command

Parameter	Description
Requests In	The number of DHCP Request messages received from clients.
Replies In	The number of DHCP Reply messages received from servers.
Relayed To Server	The number of DHCP Request messages relayed to servers.
Relayed To Client	The number of DHCP Reply messages relayed to clients.
Out To Server Failed	The number of failures when attempting to send request messages to servers. This is an internal debugging counter.
Out To Client Failed	The number of failures when attempting to send reply messages to clients. This is an internal debugging counter.
Invalid hlen	The number of incoming messages dropped due to an invalid hlen field.
Bogus giaddr	The number of incoming DHCP Reply messages dropped due to bogus giaddr field.
Corrupt Agent Option	The number of incoming DHCP Reply messages dropped due to corrupt agent option.
Missing Agent Option	The number of incoming DHCP Reply messages dropped due to missing agent option.

Table 76-2: Parameters in the output of the **show counter dhcp-relay** command (cont.)

Parameter	Description
Bad Circuit ID	The number of incoming DHCP Reply messages dropped due to bad circuit ID.
Missing Circuit ID	The number of incoming DHCP Reply messages dropped due to missing circuit ID.
Option Insert Failed	<p>The number of incoming DHCP Request messages dropped due to an error adding the relay agent information (option 82). This counter increments when:</p> <ul style="list-style-type: none"> the relay agent is set to drop packets with the option 82 field already filled by another relay agent. This policy is set with the ip dhcp-relay information policy command. there is a packet error that stops the relay agent from being able to append the packet with its relay agent option information.

Related Commands `service dhcp-relay`
 `show ip dhcp-relay`

show counter dhcp-server

This command shows counters for the DHCP server on your device.

For information on output options, see “Controlling “show” Command Output” on page 1.35.

Syntax show counter dhcp-server

Mode User Exec and Privileged Exec

Example To display counters for the DHCP server on your device, use the command:

```
awplus# show counter dhcp-server
```

Output Figure 76-3: Example output from the **show counter dhcp-server** command

```
DHCP server counters
DHCPDISCOVER in      ..... 20
DHCPPREQUEST in     ..... 12
DHCPPDECLINE in     ..... 1
DHCPPRELEASE in     ..... 0
DHCPPINFORM in      ..... 0
DHCPOFFER out       ..... 8
DHCPPACK out        ..... 4
DHCPPNAK out        ..... 0
BOOTREQUEST in      ..... 0
BOOTREPLY out       ..... 0
```

Table 76-3: Parameters in the output of the show counter dhcp-server command

Parameter	Description
DHCPDISCOVER in	The number of Discover messages received by the DHCP server.
DHCPPREQUEST in	The number of Request messages received by the DHCP server.
DHCPPDECLINE in	The number of Decline messages received by the DHCP server.
DHCPPRELEASE in	The number of Release messages received by the DHCP server.
DHCPPINFORM in	The number of Inform messages received by the DHCP server.
DHCPOFFER out	The number of Offer messages sent by the DHCP server.
DHCPPACK out	The number of Acknowledgement messages sent by the DHCP server.
DHCPPNAK out	The number of Negative Acknowledgement messages sent by the DHCP server. The server sends these after receiving a request that it cannot fulfil because either there are no available IP addresses in the related address pool, or the request has come from a client that doesn't fit the network setting for an address pool.
BOOTREQUEST in	The number of bootp messages received by the DHCP server from bootp clients.
BOOTREPLY out	The number of bootp messages sent by the DHCP server to bootp clients.

Related Commands `service dhcp-server`
`show ip dhcp binding`
`show ip dhcp server statistics`
`show ip dhcp pool`

show dhcp lease

This command shows details about the leases that the DHCP client has acquired from a DHCP server for interfaces on the device.

For information on output options, see [“Controlling “show” Command Output” on page 1.35.](#)

Syntax `show dhcp lease [<interface>]`

Parameter	Description
<interface>	Interface name to display dhcp lease details for.

Mode User Exec and Privileged Exec

Example To show the current lease expiry times for all interfaces, use the command:

```
awplus# show dhcp lease
```

To show the current lease for vlan1, use the command:

```
awplus# show dhcp lease vlan1
```

Output Figure 76-4: Example output from the **show dhcp lease** command

```
Interface vlan1
-----
IP Address:                192.168.22.4
Expires:                   13 Mar 2007 20:10:19
Renew:                     13 Mar 2007 18:37:06
Rebind:                    13 Mar 2007 19:49:29
Server:
Options:
  subnet-mask              255.255.255.0
  routers                  19.18.2.100,12.16.2.17
  dhcp-lease-time          3600
  dhcp-message-type        5
  domain-name-servers      192.168.100.50,19.88.200.33
  dhcp-server-identifier   192.168.22.1
  domain-name               alliedtelesis.com

Interface vlan2
-----
IP Address:                100.8.16.4
Expires:                   13 Mar 2007 20:15:39
Renew:                     13 Mar 2007 18:42:25
Rebind:                    13 Mar 2007 19:54:46
Server:
Options:
  subnet-mask              255.255.0.0
  routers                  10.58.1.51
  dhcp-lease-time          1000
  dhcp-message-type        5
  dhcp-server-identifier   100.8.16.1
```

Related Commands [ip address dhcp](#)

show ip dhcp binding

This command shows the lease bindings that the DHCP server has allocated clients.

For information on output options, see [“Controlling “show” Command Output” on page 1.35.](#)

Syntax `show ip dhcp binding [<ip-address> | <address-pool>]`

Parameter	Description
<code><ip-address></code>	IPv4 address of a leased IP address, in dotted decimal notation. This displays the lease information for the specified IP address.
<code><address-pool></code>	Name of an address pool. This displays the lease information for all clients within the address pool.

Mode User Exec and Privileged Exec

Examples To display all leases for every client in all address pools, use the command:

```
awplus# show ip dhcp binding
```

To display the details for the leased IP address 172.16.2.16, use the command:

```
awplus# show ip dhcp binding 172.16.2.16
```

To display the leases from the address pool MyPool, use the command:

```
awplus# show ip dhcp binding MyPool
```

Output Figure 76-5: Example output from the `show ip dhcp binding` command

```
Pool 30_2_network Network 172.16.2.0/24
DHCP Client Entries
IP Address      ClientId                Type      Expiry
-----
172.16.2.100    0050.fc82.9ede         Dynamic   21 Sep 2007 19:02:58
172.16.2.101    000e.a6ae.7c14         Static    Infinite
172.16.2.102    000e.a6ae.7c4c         Static    Infinite
172.16.2.103    000e.a69a.ac91         Static    Infinite
172.16.2.104    00e0.189d.5e41         Static    Infinite
172.16.2.150    00e0.2b04.5800         Static    Infinite
172.16.2.167    4444.4400.35c3         Dynamic   21 Sep 2007 14:58:41
```

Related Commands

- `clear ip dhcp binding`
- `ip dhcp pool`
- `lease`
- `range`
- `service dhcp-server`
- `show ip dhcp pool`

show ip dhcp pool

This command displays the configuration details and system usage of the DHCP address pools configured on the device.

For information on output options, see [“Controlling “show” Command Output” on page 1.35.](#)

Syntax `show ip dhcp pool [<address-pool>]`

Parameter	Description
<address-pool>	Name of a specific address pool. This displays the configuration of the specified address pool only.

Mode User Exec and Privileged Exec

Example 1

```
awplus# show ip dhcp pool
```

Output Figure 76-6: Example output from the `show ip dhcp pool` command

```
Pool p1 :
network: 192.168.1.0/24
address ranges:
  addr: 192.168.1.10 to 192.168.1.18
static host addresses:
  addr: 192.168.1.12      MAC addr: 1111.2222.3333
lease <days:hours:minutes:seconds> <1:0:0:0>
subnet mask: 255.255.255.0 (pool's network mask)
Dynamic addresses:
  Total:      8
  Leased:     2
  Utilization: 25.0 %
Static host addresses:
  Total:      1
  Leased:     1
```

Example 2

```
awplus# show ip dhcp pool
```

Output Figure 76-7: Example output from the **show ip dhcp pool** command with IP address 192.168.1.12 assigned to a VLAN interface on the device:

```
Pool p1 :
network: 192.168.1.0/24
address ranges:
  addr: 192.168.1.10 to 192.168.1.18
        (interface addr 192.168.1.12 excluded)
        (static host addr 192.168.1.12 excluded)
static host addresses:
  addr: 192.168.1.12      MAC addr: 1111.2222.3333
        (= interface addr, so excluded)
lease <days:hours:minutes:seconds> <1:0:0:0>
subnet mask: 255.255.255.0 (pool's network mask)
Dynamic addresses:
  Total:      8
  Leased:    2
  Utilization: 25.0 %
Static host addresses:
  Total:      1
  Leased:    1
```

Table 76-4: Parameters in the output of the show ip dhcp pool command

Parameter	Description
Pool	Name of the pool.
network	Subnet and mask length of the pool.
address ranges	Individual IP addresses and address ranges configured for the pool. The DHCP server can offer clients an IP address from within the specified ranges only. Any of these addresses that match an interface address on the device, or a static host address configured in the pool, will be automatically excluded from the range, and a message to this effect will appear beneath the range entry.
static host addresses	The static host addresses configured on the pool. Each IP address is permanently assigned to the client with the matching MAC address. Any of these addresses that match an interface address on the device will be automatically excluded, and a message to this effect will appear beneath the static host entry.
lease <days:hours:minutes>	The lease duration for address allocated by this pool.
domain	The domain name sent by the pool to clients. This is the domain name that the client should use when resolving host names using DNS.
subnet mask	The subnet mask sent by the pool to clients.
dns servers	The DNS server addresses sent to by the pool to clients.
default-router(s)	The default router addresses sent by the pool to clients.
user-defined options	The list of user-defined options sent by the pool to clients.
Dynamic addresses - Total	The total number of IP addresses that have been configured in the pool for dynamic allocation to DHCP clients.

Table 76-4: Parameters in the output of the `show ip dhcp pool` command (cont.)

Parameter	Description
Dynamic addresses - Leased	The number of IP addresses in the pool that have been dynamically allocated (leased) to DHCP clients.
Dynamic addresses - Utilization	The percentage of IP addresses in the pool that are currently dynamically allocated to clients.
Static host addresses - Total	The number of static IP addresses configured in the pool for specific DHCP client hosts.
Static host addresses - Leased	The number of static IP addresses assigned to specific DHCP client hosts.

Example 3 To display the configuration and usage details for all DHCP pools, use the command:

```
awplus# show ip dhcp pool
```

Related Commands

- `ip dhcp pool`
- `range`
- `service dhcp-server`
- `subnet-mask`

show ip dhcp-relay

This command shows the configuration of the DHCP relay agent on each interface.

For information on output options, see [“Controlling “show” Command Output” on page 1.35.](#)

Syntax `show ip dhcp-relay [interface <interface>]`

Parameter	Description
<interface>	Name of a specific interface. This displays the DHCP configuration for the specified interface only.

Mode User Exec and Privileged Exec

Example To display the DHCP relay agent's configuration on the interface `vlan100`, use the command:

```
awplus# show ip dhcp-relay interface vlan100
```

Output [Figure 76-8: Example output from the show ip dhcp-relay command](#)

```
DHCP Relay Service is enabled

vlan100 is up, line protocol is up
Maximum hop count is 10
Insertion of Relay Agent Option is disabled
Checking of Relay Agent Option is disabled
Relay information policy is to append new relay agent information
List of servers : 192.168.1.200
```

Related Commands

- [ip dhcp-relay agent-option](#)
- [ip dhcp-relay agent-option checking](#)
- [ip dhcp-relay information policy](#)
- [ip dhcp-relay maxhops](#)
- [ip dhcp-relay server-address](#)

show ip dhcp server statistics

This command shows statistics related to the DHCP server.

You can display the server counters using the `show counter dhcp-server` command as well as with this command.

For information on output options, see ["Controlling "show" Command Output" on page 1.35.](#)

Syntax `show ip dhcp server statistics`

Mode User Exec and Privileged Exec

Example To display the server statistics, use the command:

```
awplus# show ip dhcp server statistics
```

Output Figure 76-9: Example output from the `show counter dhcp server statistics` command

```
DHCP server counters
DHCPDISCOVER in      ..... 20
DHCPPREQUEST in     ..... 12
DHCPPDECLINE in     ..... 1
DHCPPRELEASE in     ..... 0
DHCPPINFORM in      ..... 0
DHCPOFFER out       ..... 8
DHCPPACK out        ..... 4
DHCPPNAK out        ..... 0
BOOTREQUEST in      ..... 0
BOOTREPLY out       ..... 0
```

Figure 76-10: Parameters in the output of the `show counter dhcp server statistics` command

Parameter	Description
DHCPDISCOVER in	The number of Discover messages received by the DHCP server.
DHCPPREQUEST in	The number of Request messages received by the DHCP server.
DHCPPDECLINE in	The number of Decline messages received by the DHCP server.
DHCPPRELEASE in	The number of Release messages received by the DHCP server.
DHCPPINFORM in	The number of Inform messages received by the DHCP server.
DHCPOFFER out	The number of Offer messages sent by the DHCP server.
DHCPPACK out	The number of Acknowledgement messages sent by the DHCP server.
DHCPPNAK out	The number of Negative Acknowledgement messages sent by the DHCP server. The server sends these after receiving a request that it cannot fulfil because either there are no available IP addresses in the related address pool, or the request has come from a client that doesn't fit the network setting for an address pool.
BOOTREQUEST in	The number of bootp messages received by the DHCP server from bootp clients.
BOOTREPLY out	The number of bootp messages sent by the DHCP server to bootp clients.

Related Commands `show counter dhcp-server`
`service dhcp-server`
`show ip dhcp binding`
`show ip dhcp pool`

show ip dhcp server summary

This command shows the current configuration of the DHCP server. This includes:

- whether the DHCP server is enabled
- whether the DHCP server is configured to ignore BOOTP requests
- the details of any user-defined options
- a list of the names of all DHCP address pools currently configured

This show command does not include any configuration details of the address pools. You can display these using the `show ip dhcp pool` command.

For information on output options, see “Controlling “show” Command Output” on page 1.35.

Syntax `show ip dhcp server summary`

Mode User Exec and Privileged Exec

Example To display the current configuration of the DHCP server, use the command:

```
awplus# show ip dhcp server summary
```

Output Figure 76-11: Example output from the `show ip dhcp` command

```
dhcp server enabled
dhcp server BOOTP ignore disabled
dhcp server user-defined option definitions:
  num: 46   name: tcpip-node-type   type: hex string
  num: 175  name: special-address         type: IP address
  num: 179  name:                               type: integer
dhcp pool list: p1 p2
```

Related Commands `ip dhcp pool`
`service dhcp-server`

subnet-mask

This command sets the subnet mask option for a DHCP address pool you are configuring. Use this command to specify the client's subnet mask as defined in RFC 950. This sets the subnet details using the pre-defined option 1. Note that if you create a user-defined option 1 using the [option](#) command, then you will override any settings created with this command. If you do not specify a subnet mask using this command, then the pool's network mask (specified using the [next-server](#) command) is applied.

The **no** variant of this command removes a subnet mask option from a DHCP pool. The pool reverts to using the pool's network mask.

Syntax `subnet-mask <mask>`

`no subnet-mask`

Parameter	Description
<code><mask></code>	Valid IPv4 subnet mask, in dotted decimal notation.

Mode DHCP Configuration

Examples To set the subnet mask option to 255.255.255.0 for DHCP pool P2, use the commands:

```
awplus# configure terminal
awplus(config)# ip dhcp pool P2
awplus(dhcp-config)# subnet-mask 255.255.255.0
```

To remove the subnet mask option from DHCP pool P2, use the commands:

```
awplus# configure terminal
awplus(config)# ip dhcp pool P2
awplus(dhcp-config)# no subnet-mask
```

Related Commands

- [default-router](#)
- [dns-server](#)
- [domain-name](#)
- [next-server](#)
- [option](#)
- [service dhcp-server](#)
- [show ip dhcp pool](#)

Chapter 77: SNMP Introduction



Introduction.....	77.2
Network Management Framework.....	77.2
Structure of Management Information.....	77.4
Names.....	77.5
Instances.....	77.6
Syntax.....	77.6
Access.....	77.6
Status.....	77.7
Description.....	77.7
The SNMP Protocol.....	77.8
SNMP Versions.....	77.8
SNMP Messages.....	77.8
Polling versus Event Notification.....	77.9
Message Format for SNMPv1 and SNMPv2c.....	77.9
SNMP Communities (Version v1 and v2c).....	77.10
SNMPv3 Entities.....	77.10
SNMP Engine.....	77.10
SNMPv3 Message Protocol Format.....	77.11
SNMPv1 and SNMPv2c.....	77.12
SNMP MIB Views for SNMPv1 and SNMPv2c.....	77.12
SNMP Communities.....	77.12
Configuration Example (SNMPv1 and v2).....	77.14
SNMPv3.....	77.17
SNMP MIB Views for SNMPv3.....	77.17
SNMP Groups.....	77.17
SNMP Users.....	77.17
SNMP Target Addresses.....	77.17
SNMP Target Params.....	77.17
Configuration Example (SNMPv3).....	77.18
Using SNMP to Manage Files and Software.....	77.18
Copy a File to or from a TFTP Server.....	77.19
Upgrade Software and Configuration Files.....	77.20

Introduction

The Simple Network Management Protocol (SNMP) is the network management protocol of choice for the Internet and IP-based internetworks.

This chapter describes the main features of SNMP Version 1 (SNMPv1), SNMP Version 2c (SNMPv2c) and Version 3 (SNMPv3). It also describes support for SNMP on the switch, and how to configure the switch's SNMP agent.

Unless a particular version of SNMP is named, "SNMP" in this chapter refers to versions SNMPv1, SNMPv2c and SNMPv3.

See also [Chapter 78, SNMP Commands](#) and [Chapter 79, SNMP MIBs](#).

Network Management Framework

A network management system has the following components:

- One or more *managed devices*, each containing an agent that provides the management functions. A managed device may be any computing device with a network capability, for example, a host system, workstation, terminal server, printer, router, switch, bridge, hub or repeater.
- One or more *Network Management Stations (NMS)*. An NMS is a host system running a network management protocol and network management applications, enabling the user to manage the network.
- A *network management protocol* used by the NMS and agents to exchange information.

Figure 77-1: Components of a network management system

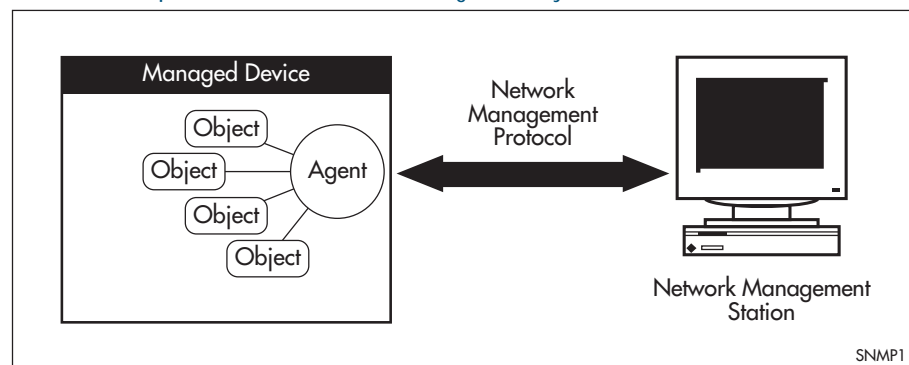

The Internet-standard Network Management Framework is the framework used for network management in the Internet. The framework was originally defined by the following documents:

- RFC 1155, *Structure and identification of management information for TCP/IP based internets* (referred to as the SMI), details the mechanisms used to describe and name the objects to be managed.
- RFC 1213, *Management Information Base for network management of TCP/ IP-based internets: MIB-II* (referred to as MIB-II), defines the core set of managed objects for the Internet suite of protocols. The set of managed objects can be extended by adding other MIBs specific to particular protocols, interfaces or network devices.
- RFC 1157, *A Simple Network Management Protocol (SNMP)*, is the protocol used for communication between management stations and managed devices.

Subsequent documents that have defined SNMPv2c are:

- RFC 1901, *Introduction to Community-based SNMPv2*
- RFC 1902, *Structure of Management Information for Version 2 of the Simple Network Management Protocol (SNMPv2)*
- RFC 1903, *Textual Conventions for Version 2 of the Simple Network Management Protocol (SNMPv2)*
- RFC 1904, *Conformance Statements for Version 2 of the Simple Network Management Protocol*
- RFC 1905, *Protocol Operations for Version 2 of the Simple Network Management Protocol (SNMPv2)*
- RFC 1906, *Transport Mappings for Version 2 of the Simple Network Management Protocol (SNMPv2)*
- RFC 1907, *Management Information Base for Version 2 of the Simple Network Management Protocol (SNMPv2)*
- RFC 2576, *Coexistence between Version 1, Version 2, and Version 3 of the Internet-standard Network Management Framework*
- RFC 2578, *Structure of Management Information Version 2 (SMIv2)*
- RFC 2579, *Textual Conventions for SMIv2*
- RFC 2580, *Conformance Statements for SMIv2*

Subsequent documents that have defined SNMPv3 are:

- RFC 3410, *Introduction and Applicability Statements for Internet Standard Management Framework*
- RFC 3411, *An Architecture for Describing Simple Network Management Protocol (SNMP) Management Frameworks*
- RFC 3412, *Message Processing and Dispatching for the Simple Network Management Protocol (SNMP)*
- RFC 3413, *Simple Network Management Protocol (SNMP) Applications*
- RFC 3414, *User-based Security Model (USM) for version 3 of the Simple Network Management Protocol (SNMPv3)*
- RFC 3415, *View-based Access Control Model (VACM) for the Simple Network Management Protocol (SNMP)*
- RFC 3416, *Version 2 of the Protocol Operations for the Simple Network Management Protocol (SNMP)*
- RFC 3417, *Transport Mappings for the Simple Network Management Protocol (SNMP)*
- RFC 3418, *Management Information Base (MIB) for the Simple Network Management Protocol (SNMP)*

Structure of Management Information

The structure of management information (SMI) defines the schema for a collection of managed objects residing in a virtual store called the management information base (MIB). The information in a MIB includes administrative and operational configuration information, as well as counters of system events and activities.

The MIB is organized into a tree-like hierarchy in which nodes are each assigned an identifier consisting of a non-negative integer and an optional brief textual description.

Each managed object is represented by a leaf node and is defined by its name, syntax, access mode, status and description. It can also be specifically identified by its unique position within the tree. This position is expressed as a series of dot-delimited sub-identifiers that start at the root node and end in the sub-identifier at the particular object's leaf node. For example, in [Figure 77-2](#) the object named interfaces would be uniquely identified by the string of individual sub-identifiers, 1.3.6.1.2.1.2.

Figure 77-2: Top levels of the Internet-standard Management Information Base (MIB)

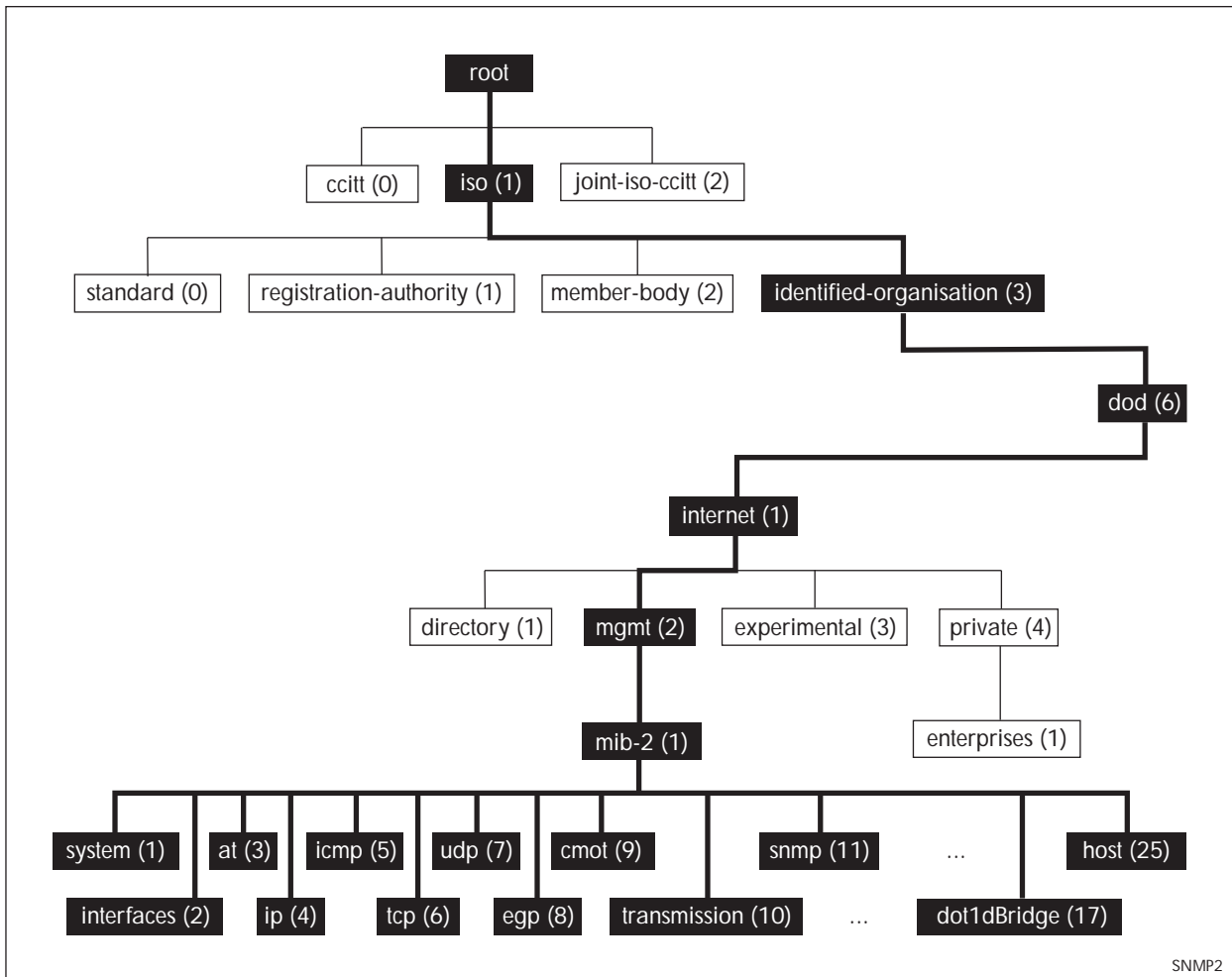

Objects defined in the Internet-standard MIB (MIB-II) reside in the mib(1) sub-tree.

Names

Names are used to identify managed objects, and are hierarchical in nature. An object identifier is a globally unique, authoritatively assigned sequence of non-negative integers which traverse the MIB tree from the root to the node containing the object.

Object identifiers may be represented in one of the following forms:

- Dotted notation lists the integer values found by traversing the tree from the root to the node in question, separated by dots. For example, the following identifies the MIB-II sub-tree:

```
1.3.6.1.2.1
```

The following identifies the sysDescr object in the system group of MIB-II:

```
1.3.6.1.2.1.1.1
```

- Textual notation lists the textual descriptions found by traversing the tree from the root to the node in question, separated by spaces and enclosed in braces. For following example identifies the internet sub-tree:

```
{ iso org dod 1 }
```

The name may be abbreviated to a relative form. The following example identifies the first (directory) node of the internet sub-tree:

```
{ internet 1 }
```

- Combined notation lists both the integer values and textual descriptions found by traversing the tree from the root to the node in question. The integer value is placed in parentheses after the textual description. The labels are separated by spaces and enclosed in braces. For example, the following identifies the first (directory) node in the internet sub-tree:

```
{iso(1) org(3) dod(6) internet(1) 1}
```

The name may be abbreviated to the following:

```
directory(1)
```

Since there is no effective limit to the magnitude of non-negative integers, and no effective limit to the depth of the tree, the MIB provides an unlimited name space.

An object is also usually assigned an object descriptor. The object descriptor is a unique, mnemonic, printable string intended for humans to use when discussing the MIB.

Instances

Objects are just templates for data types. An actual value that can be manipulated by an NMS is an instance of an object. An instance is named by appending an instance identifier to the end of the object's object identifier. The instance identifier depends on the object's data type:

- If the object is not a column in a table, the instance identifier is 0 (zero). For example, the instance of the sysDescr object is:

```
sysDescr.0
or 1.3.6.1.2.1.1.1.0
```

- If the object is a column in a table, the method used to assign an instance identifier varies. Typically, the value of the index column or columns is used.

The object ifTable in MIB-II contains information about interfaces and is indexed by the interface number, ifIndex. The instance of the ifDescr object for the first interface is:

```
ifDescr.1
or 1.3.6.1.2.1.2.2.1.2.1
```

If the index column is an IP address, the entire IP address is used as the instance identifier. The object ipRouteTable in MIB-II contains information about IP routes and is indexed by the destination address, ipRouteDest. The instance of the ipRouteNextHop object for the route 131.203.9.0 is:

```
ipRouteNextHop.131.203.9.0
or 1.3.6.1.2.1.4.21.1.7.131.203.9.0
```

If the table has more than one index, the values of all the index columns are combined to form the instance identifier. The object tcpConnTable in MIB-II contains information about existing TCP connections and is indexed by the local IP address (tcpConnLocalAddress), the local port number (tcpConnLocalPort), the remote IP address (tcpConnRemAddress) and the remote port number (tcpConnRemPort) of the TCP connection. The instance of the tcpConnState object for the connection between 131.203.8.36,23 and 131.203.9.197,1066 is:

```
tcpConnState.131.203.8.36.23.131.203.9.197.1066
or 1.3.6.1.2.1.6.13.1.1.131.203.8.36.23.131.203.9.197.1066
```

Syntax

The syntax of an object describes the abstract data structure corresponding to that object type. For example, INTEGER or OCTET STRING.

Access

The access mode of an object describes the level of access for the object.

Access modes for MIB objects:

Access	Description
Read-only	The object's value can be read but not set.
Read-write	The object's value can be read and set.
Write-only	The object's value can be set but not read.
Not-accessible	The object's value cannot be read or set.

Status

The status of an object describes the implementation requirements for the object.

Status values for MIB objects:

Status	Description
Mandatory	Managed devices must implement the object.
Optional	Managed devices may implement the object.
Obsolete	Managed devices need no longer implement the object.
Deprecated	Managed devices should implement the object. However, the object may be deleted from the next version of the MIB. A new object with equal or superior functionality is defined.

Description

The definition of an object may include an optional textual description of the meaning and use of the object. This description is often essential for successful understanding of the object.

The SNMP Protocol

The SNMP protocol provides a mechanism for management entities, or stations, to extract information from the Management Information Base (MIB) of a managed device.

The normal method of accessing information in a MIB is to use a Network Management Station (NMS), typically a PC or workstation, to send commands to the managed device (in this case the switch) using the SNMP protocol.

SNMP can use a number of different protocols as its underlying transport mechanism, but the most common transport protocol, and the only one supported by the switch, is UDP. Therefore the IP module must be enabled and properly configured in order to use SNMP. SNMP trap messages are sent to UDP port 162; all other SNMP messages are sent to UDP port 161. The switch's SNMP agent accepts SNMP messages up to the maximum UDP length the switch can receive.

Other transport mappings have been defined (e.g. OSI [RFC 1418], AppleTalk [RFC 1419] and IPX [RFC 1420]), but the standard transport mapping for the Internet (and the one the switch uses) is UDP. The IP module must be enabled and configured correctly. See [Chapter 23, IP Addressing and Protocol Commands](#) for detailed descriptions of the commands required to enable and configure IP.

SNMP Versions

The switch supports SNMP version 1 (SNMPv1), SNMP version 2c (SNMPv2c) and SNMP Version 3 (SNMPv3). The three versions operate similarly.

SNMPv2c updated the original protocol, and offered the following main enhancements:

- a new format for trap messages.
- the get-bulk-request PDU allows for the retrieval of large amounts of data, including tables, with one message.
- more error codes mean that error responses to set messages have more detail than is possible with SNMPv1.
- three new exceptions to errors can be returned for get, get-next and get-bulk-request messages. These are: noSuchObject, noSuchInstance, and endOfMibView.

SNMPv3 provides significant enhancements to address the security weaknesses existing in the earlier versions. This is achieved by implementing two new major features:

- Authentication - by using password hashing and time stamping.
- Privacy - by using message encryption.

Support for multiple versions of SNMP is achieved by responding to each SNMP request with a response of the same version. For example, if an SNMPv1 request is sent to the switch, an SNMPv1 response is returned. If an SNMPv2c request is sent, an SNMPv2c response is returned. Therefore, authentication and encryption functions are not invoked when messages are detected as having either an SNMPv1 or SNMPv2c protocol format.

SNMP Messages

The SNMP protocol is termed simple because it has only six operations, or messages—get, get-next, get-response, set, and trap, and SNMPv2c also has the get-bulk-request message. The replies from the managed device are processed by the NMS and generally used to provide a graphical representation of the state of the network. The two major SNMP operations available to a management station for interacting with a client are the get and set operations. The SNMP

set operator can lead to security breaches, since SNMP is not inherently very secure. When forced to operate in either SNMPv1 or v2 mode, when operating with older management stations for example, care must be taken in the choice and safe-guarding of community names, which are effectively passwords for SNMP.

Polling versus Event Notification

SNMP employs a polling paradigm. A Network Management Station (NMS) polls the managed device for information as and when it is required, by sending get-request, get-next-request, and/or get-bulk-request PDUs to the managed device. The managed device responds by returning the requested information in a get-response PDU. The NMS may manipulate objects in the managed device by sending a set-request PDU to the managed device.

The only time that a managed device initiates an exchange of information is in the special case of a trap PDU. A managed device may generate a limited set of traps to notify the NMS of critical events that may affect the ability of the NMS to communicate with the managed device or other managed devices on the network, and therefore to "manage" the network. Such events include the restarting or re-initialization of a device, a change in the status of a network link (up or down), or an authentication failure.

Message Format for SNMPv1 and SNMPv2c

Fields in an SNMP message:

Field	Function
Version	The version of the SNMP protocol. The value is version-1 (0) for the SNMP protocol as defined in RFC 1157, or version-2c (1) for the SNMP protocol as defined in RFC 1902.
Community	The name of an SNMP community, for authentication purposes
SNMP PDU	An SNMP Protocol Data Unit (PDU).

SNMP PDUs:

PDU	Function
get-request	Sent by an NMS to an agent, to retrieve the value of an object.
get-next-request	Sent by an NMS to an agent, to retrieve the value of the next object in the sub-tree. A sub-tree is traversed by issuing a get-request PDU followed by successive get-next-request PDUs.
get-bulk-request	Sent by an NMS to an agent to request a large amount of data with a single message. This is for SNMPv2c messages.
set-request	Sent by an NMS to an agent, to manipulate the value of an object. SNMP PDU Version Community
get-response	Sent by an agent to an NMS in response to a get-request, get-next-request, get-bulk-response, or set-request PDU.
trap	Sent by an agent to an NMS to notify the NMS of an extraordinary event.
report	Although not explicitly defined in the RFCs, reports are used for specific purposes such as EngineID discovery and time synchronization.

Generic SNMP traps

Value	Meaning
coldStart	The agent is re-initializing itself. Objects may be altered.
warmStart	The agent is re-initializing itself. Objects are not altered.
linkDown	An interface has changed state from up to down.
linkUp	An interface has changed state from down to up.
authenticationFailure	An SNMP message has been received with an invalid community name.
egpNeighborLoss	An EGP peer has transitioned to down state.

SNMP Communities (Version v1 and v2c)

A community is a relationship between an NMS and an agent. The community name is used like a password for a trivial authentication scheme. Both SNMPv1 and SNMPv2c provide security based on the community name only. The concept of communities does not exist for SNMPv3, which instead provides for a far more secure communications method using entities, users, and groups.

Caution  We strongly recommend removing community membership from all SNMPv3 configured devices to prevent access to them via SNMPv1 and SNMPv2c, which could bypass the additional SNMPv3 security features.

SNMPv3 Entities

Entities comprise one of the basic components of the SNMPv3 enhanced architecture. They define the functionality and internal structure of the SNMP managers and agents. An in-depth description of entities can be found in RFC 3411, on which the following text is based. SNMPv3 defines two entity types, a manager and an agent. Both entity types contain two basic components: an SNMP engine and a set of applications.

SNMP Engine

The engine provides the basic services to support the agents component applications, in this respect it performs much of the functionality expected of the ISO Session and Presentation layers. These functions include, message transmission and reception, authentication and encryption, and access control to its managed objects database (MIB). The SNMP engine comprises the following components:

- Dispatcher
- Message processing Subsystem
- Security Subsystem
- Access Control Subsystem

The only security subsystem presently supported is the user based security model (USM).

Each SNMP engine is identified by an `snmpEngineID` that must be unique within the management system. A one to one association exists between an engine and the entity that contains it.

Entity Applications

The following applications are defined within the agent applications:

- Command Generator
- Notification Receiver
- Proxy Forwarder
- Command Responder
- Notification Originator
- Other

SNMPv3 Message Protocol Format

SNMPv3 PDUs

Value	Meaning
msgVersion	Identifies the message format to be SNMPv3.
msgID	An identifier used between SNMP entities to coordinate message requests and responses. Note that a message response takes the msgID value of the initiating message.
msgMaxSize	Conveys the maximum message size (in octets) an integer between 484 and $2^{31}-1$, supported by the sender of the message. Specified as msgFlags. A single octet whose last three bits indicate the operational mode for privacy, authentication, and report.
msgSecurityModel	An identifier used to indicate the security mode (i.e. SNMPv1, SNMPv2c or SNMPv3) to be used when processing the message. Note that although only the SNMPv3 identifier is accepted by the switch, these earlier version message formats are detected by the msgVersion field and processed appropriately.
msgAuthoritativeEngineID	The ID of the authoritative engine that relates to a particular message, i.e. the source engine ID for Traps, Responses and Reports, and the destination engine for Gets, GetNexts, Sets, and Informs.
msgAuthoritativeEngineBoots	A value that represents the number of times the authoritative engine has rebooted since its installation. Its value has the range 1 to $2^{31}-1$.
msgAuthoritativeEngineTime	The number of seconds since the authoritative engine snmpEngineBoots counter was last incremented.
msgUserName	The name of the user (principal) on whose behalf the message is being exchanged.
msgAuthenticationParameters	If the message has been authenticated, this field contains a serialized OCTET STRING representing the first 12 octets of the HMAC-MD5-96 output done over the whole message.
msgPrivacyParameters	For encrypted data, this field contains the "salt" used to create the DES encryption Initialization Vector (IV).
ContextEngineID	Within a particular administrative domain, this field uniquely identifies an SNMP entity that may realize an instance of a context with a particular contextName
ContextName	A unique name given to a context within a particular SNMP entity.

SNMPv1 and SNMPv2c

Although software levels 2.6.3 and higher support the specific facilities of SNMP v1 and v2, their documentation is available to provide backward compatibility with older network management systems. The far superior security features offered by implementing SNMPv3 should be used wherever possible.

The switch's implementation of SNMPv1 is based on RFC 1157, *A Simple Network Management Protocol (SNMP)*, and RFC 1812, *Requirements for IP Version 4 Routers*.

When the SNMP agent is disabled, the agent does not respond to SNMP request messages. The agent is disabled by default. The current state and configuration of the SNMP agent can be displayed.

SNMP MIB Views for SNMPv1 and SNMPv2c

An SNMP MIB view is an arbitrary subset of objects in the MIB. Objects in the view may be from any part of the object name space, and not necessarily the same sub-tree. An SNMP community profile is the pairing of an SNMP access mode (read-only or read-write) with the access mode defined by the MIB for each object in the view. For each object in the view, the community profile defines the operations that can be performed on the object.

Pairing an SNMP community with an SNMP community profile determines the level of access that the agent affords to an NMS that is a member of the specified community. When an agent receives an SNMP message, it checks the community name encoded in the message. If the agent knows the community name, the message is deemed to be authentic and the sending SNMP entity is accepted as a member of the community. The community profile associated with the community name then determines the sender's view of the MIB and the operations that can be performed on objects in the view.

SNMP Communities

SNMP communities were introduced into SNMPv1 and retained in version 2c. Although the switch's software still supports communities, this is to provide backward compatibility with legacy management systems. Communities should not be used where a secure network is required. Instead, use the secure network features offered by SNMPv3.

An SNMP community is a pairing of an SNMP agent with a set of SNMP application entities. Communities are the main configuration item in the switch's implementation of SNMPv1 and v2, and are defined in terms of a list of IP addresses which define the SNMP application entities (trap hosts and management stations) in the community.

Important community names act as passwords and provide minimal authentication. Any SNMP application entity that knows a community name can read the value of any instance of any object in the MIB implemented in the switch. Any SNMP application entity that knows the name of a community with write access can change the value of any instance of any object in the MIB implemented in the switch, possibly affecting the operation of the switch. For this reason, take care with the security of community names.

When a trap is generated by the SNMP agent it is forwarded to all trap hosts in all communities. The community name and manager addresses are used to provide trivial authentication. An incoming SNMP message is deemed authentic if it contains a valid community name and originated from an IP address defined as a management station for that community.

When a community is disabled, the SNMP agent behaves as if the community does not exist and generates authentication failure traps for messages directed to the disabled community.

The SNMP agent does not support a default community called "public" with read-only access, traps disabled and open access as mandated in RFC 1812, as this is a security hole open for users who wish to use the switch with minimal modification to the default configuration. The default configuration of the switch has no defined communities. Communities must be explicitly created.

SNMP authentication (for SNMPv1 and v2) is a mechanism whereby an SNMP message is declared to be authentic, that is from an SNMP application entity actually in the community to which the message purports to belong. The mechanism may be trivial or secure. The only form of SNMP authentication implemented by the switch's SNMP agent is trivial authentication. The authentication failure trap may be generated as a result of the failure to authentication an SNMP message.

Switch interfaces can be enabled or disabled via SNMP by setting the ifAdminStatus object in the ifTable of MIB-II MIB to 'Up(1)' or 'Down(2)' for the corresponding ifIndex. If it is not possible to change the status of a particular interface the switch returns an SNMP error message.

The switch's implementation of the ifOperStatus object in the ifTable of MIB-II MIB supports two additional values—"Unknown(4)" and "Dormant(5)" (e.g. an inactive dial-on-demand interface).

Caution  An unauthorized person with knowledge of the appropriate SNMP community name could bring an interface up or down. Community names act as passwords for the SNMP protocol. When creating an SNMP community with write access, take care to select a secure community name and to ensure that only authorized personnel know it.

An SNMP MIB view is a subset of objects in the MIB that pertain to a particular network element. For example, the MIB view of a hub would be the objects relevant to management of the hub, and would not include IP routing table objects, for example. The switch's SNMP agent does not allow the construction of MIB views. The switch supports all relevant objects from all MIBs that it implements.

Note that the switch's standard set and show commands can also be used to access objects in the MIBs supported by the switch.

Defining Management Stations within Communities

You can add management stations to a community either individually, by entering just its IP address, or you can enter a range of management stations by entering an IP address that ends with a '/' character followed by a number between 1 and 32. The number that follows the '/' character operates as an address mask to define a range of addresses for the management stations. The following example shows how to allocate a band of three binary addresses to a portion of the subnet 146.15.1.X

Example In this example we make provision for up to 8 possible management stations within a community called "admin".

Step 1:

Decide on the number of management stations that you want to assign to a particular subnet, then decide how many binary digits are required to define this number of addresses. In this case we need up to 8 management stations, so we will assign 3 binary digits (3 binary digits can provide 8 different values). To assign the last 3 binary digits for management stations, we assign a prefix that is a count of all binary digits in the address minus those to be assigned as management stations. In this case the prefix is 29; this being the number of binary digits in an IP address (32) minus the number of digits assigned to the management stations (3).

Step 2:

The method used in this step depends on whether or not the community already exists.

- If the community called “admin” does not exist, create a new community called “admin” and allocate a three binary digit block of addresses to the address subnet 146.15.1.X.
- If the community called “admin” already exists, allocate a three binary digit block of addresses to an existing community called “admin” with the address subnet 146.15.1.X.

For security reasons, the common management prefix should be larger than the IP subnet. This prevents stations on one subnet from being considered valid management stations on a different subnet.

Configuration Example (SNMPv1 and v2)

This example shows how to configure the switch's SNMP agent. Two network management stations have been set up on a large network. The central NMS (IP address 192.168.11.5) monitors devices on the network and uses SNMP set messages to manage devices on the network. Trap messages are sent to this management station. The regional network management station (IP addresses 192.168.16.1) is used just to monitor devices on the network by using SNMP get messages. Link traps are enabled for all interfaces on this particular switch.

IP and VLANs must be correctly configured in order to access the SNMP agent in the switch. This is because the IP module handles both the TCP transport functions, and the UDP functions that enable datagrams to transport SNMP messages. See [Chapter 23, IP Addressing and Protocol Commands](#) for commands that enable and configure IP.

To configure SNMP

Step 1: Enable the SNMP agent.

Enable the SNMP agent and enable the generation of authenticate failure traps to monitor unauthorized SNMP access. SNMP is enabled by default in AlliedWare Plus.

```
awplus(config)# snmp-server enable trap auth
```

Step 2: Create a community with write access for the central NMS.

Create a write access community called “example1rw” for use by the central network management station at 192.168.11.5 Use an ACL to give the central NMS SNMP access to the switch using that community name.

```
awplus(config)# access-list 66 permit 192.168.11.5
```

```
awplus(config)# snmp-server community private rw 66
```

Care must be taken with the security of community names. Do not use the names “private” or “public” in your network because they are too obvious. Community names act as passwords and provide only trivial authentication. Any SNMP application entity that knows a community name can read the value of any instance of any object in the MIB implemented in the switch. Any SNMP application entity that knows the name of a community with write access can change the value of any instance of any object in the MIB implemented in the switch, possibly affecting the operation of the switch.

SNMP V1 or V2c provide very minimal security. If security is a concern, you should use SNMPv3.

Step 3: Create a community with read-only access for the regional NMS.

Create a read-only access community called "example1rw" for use by the regional network management station at 192.168.16.1. Use an ACL to give the regional NMS SNMP access to the switch using that community name.

```
awplus(config)# access-list 67 permit 192.168.16.1
awplus(config)# snmp-server community private rw 67
```

Step 4: Enable link traps.

Enable link traps for the desired interfaces. In this example, the NSMs are in VLAN 2 and VLAN 3 and other ports are in VLAN 1 for simplicity.

```
awplus(config)# interface vlan1-3
awplus(config-if)# snmp trap link-status
```

Note that link traps on VLANs are sent when the last port in the VLAN goes down. You will only see a trap for a VLAN if the trap host is in a different VLAN.

You can also enable link traps on channel groups and switch ports. For example, to enable traps on a range of switch ports:

```
awplus(config)# int port1.1.5-1.1.7
awplus(config-if)# snmp trap link-status
```

Step 5: Configure trap hosts.

Specify the IP address or addresses that the traps will get sent to. In this example, traps will be sent to both NMSes.

```
awplus(config)# snmp-server host 192.168.11.5 version 2c
example1rw
awplus(config)# snmp-server host 192.168.16.1 version 2c
example2ro
```

Step 6: Check the configuration.

Check that the current configuration of the SNMP communities matches the desired configuration:

```
awplus# show snmp-server
awplus# show snmp-server community
awplus# show run snmp
```

This is the output of the `show snmp-server community` command for this example:

```
SNMP community information:
Community Name ..... example1rw
Access ..... Read-write
View ..... none
Community Name ..... example2ro
Access ..... Read-only
View ..... none
```

This is the output of the `show run snmp` command for this example:

```
no snmp-server ipv6
snmp-server enable trap auth
snmp-server community example1rw rw 66
snmp-server community example2ro 67
snmp-server host 192.168.1.2 version 2c example1rw
snmp-server host 192.168.2.2 version 2c example2ro
!
```

Check that the interface link up/down traps have been correctly configured:

```
awplus# show interface vlan1-3
```

This is the output of the `show interface` command for this example:

```
Interface vlan1
  Scope: both
  Link is UP, administrative state is UP
  Hardware is VLAN, address is 0009.41fd.c029
  index 201 metric 1 mtu 1500
  arp ageing timeout 300
  <UP,BROADCAST,RUNNING,MULTICAST>
  VRF Binding: Not bound
  SNMP link-status traps: Sending (suppressed after 20 traps in 60 sec)
  Bandwidth 1g
    input packets 4061, bytes 277043, dropped 0, multicast packets 3690
    output packets 190, bytes 18123, multicast packets 0 broadcast packets 0
Interface vlan2
  Scope: both
  Link is DOWN, administrative state is UP
  Hardware is VLAN, address is 0009.41fd.c029
  IPv4 address 192.168.11.50/24 broadcast 192.168.11.255
  index 202 metric 1 mtu 1500
  arp ageing timeout 300
  <UP,BROADCAST,MULTICAST>
  VRF Binding: Not bound
  SNMP link-status traps: Sending (suppressed after 20 traps in 60 sec)
  Bandwidth 1g
    input packets 568, bytes 42309, dropped 0, multicast packets 0
    output packets 183, bytes 18078, multicast packets 0 broadcast packets 0
Interface vlan3
  Scope: both
  Link is DOWN, administrative state is UP
  Hardware is VLAN, address is 0009.41fd.c029
  IPv4 address 192.168.16.50/24 broadcast 192.168.16.255
  index 203 metric 1 mtu 1500
  arp ageing timeout 300
  <UP,BROADCAST,MULTICAST>
  VRF Binding: Not bound
  SNMP link-status traps: Sending (suppressed after 20 traps in 60 sec)
    input packets 0, bytes 0, dropped 0, multicast packets 0
    output packets 0, bytes 0, multicast packets 0 broadcast packets 0
```

SNMPv3

SNMPv3 is the third version of the Simple Network Management Protocol. The architecture comprises the following:

- entities that may be either managers, agents, or both
- a management information base (MIB)
- a transport protocol

At least one manager node runs the SNMP management software in every configuration. Managed devices such as routers, servers, and workstations are equipped with an agent software module. The agent provides access to local objects in the MIB that reflect activity and resources at the node. The agent also responds to manager commands to retrieve values from, and set values in the MIB.

SNMP MIB Views for SNMPv3

An SNMP MIB view is an arbitrary subset of objects in the MIB. Objects in the view may be from any part of the object name space, and not necessarily the same sub-tree.

SNMP Groups

Groups were introduced as part of SNMPv3. They are the means by which users are assigned their views and access control policy. Once a group has been created, users can be added to them. In practice a number of groups would be created, each with varying views and access security requirements. Users would then be added to their most appropriate groups. Each Group name and Security Level pair must be unique within a switch.

SNMP Users

Users were introduced as part of SNMPv3. From a system perspective a user is represented as an entity stored in a table that defines the access and authentication criteria to be applied to access or modify the SNMP MIB data.

SNMP Target Addresses

Target addresses were introduced as part of SNMPv3. They specify the destination and user that receives outgoing notifications such as trap messages. SNMP target address names must be unique within the managed device.

SNMP Target Params

Target params were introduced as part of SNMPv3. They specify an entry in the `snmpTargetParamsTable`. SNMP target params names must be unique within the managed device.

Configuration Example (SNMPv3)

This example shows how to configure the switch's SNMP agent. Two network management stations have been set up on a large network. The central NMS (IP address 192.168.11.5) monitors devices on the network and uses SNMP set messages to manage devices on the network. Trap messages are sent to this management station.

The IP module must be enabled and correctly configured in order to access the SNMP agent in the switch, since the IP module handles the UDP datagrams used to transport SNMP messages.

To configure SNMP

Step 1: Enable the SNMP agent.

Enable the SNMP agent and enable the generation of authenticate failure traps to monitor unauthorized SNMP access. SNMP is enabled by default in AlliedWare Plus.

Step 2: Add SNMP views.

You can specify views using their OID or the predefined MIB name.

```
awplus(config)# snmp-server view atmib 1.3.6.1.2.14
included

awplus(config)# snmp-server view atmib alliedtelesis
included
```

Step 3: Add SNMP group.

```
awplus(config)# snmp-server group ord-user noauth read
atmib

awplus(config)# snmp-server group admin-user auth read
atmib write atmib notify atmi
```

Step 4: Add SNMP users.

Add users to the groups by using commands such as:

```
awplus(config)# snmp-server user ken admin-user auth md5
mercury
```

Step 5: Add SNMP target parameters.

Step 6: Add SNMP target address.

Using SNMP to Manage Files and Software

The Allied Telesis Enterprise MIB ([Chapter 79, SNMP MIBs](#)) includes objects for managing files and software on the switch. This section includes procedures for using MIB objects on the switch to perform some common tasks, via an SNMP management application:

- [“Copy a File to or from a TFTP Server” on page 77.19](#)
- [“Upgrade Software and Configuration Files” on page 77.20](#)

For more details about the Allied Telesis Enterprise MIB and public MIBs on the switch, see [Chapter 79, SNMP MIBs](#).

Copy a File to or from a TFTP Server

Use this procedure to copy a file (for example, a software version file) to the switch from a TFTP server, or to copy a file (for example, a configuration file) from the switch to a TFTP server. The MIB objects in this procedure reside in the module atFilev2 { modules 600 }, with object ID 1.3.6.1.4.1.207.8.4.4.4.600. For detailed descriptions of the MIB objects used in this procedure, and other file management MIB objects, see ["AT-FILEv2-MIB" on page 79.49](#). Other MIB objects can be used in a similar way for moving and deleting files on the switch.

Table 77-1: Procedure for copying a file to or from a device using a TFTP server

Do this ...	By setting or reading this MIB object ...	Whose object ID is ...	To this value...
1. If the source device is part of a stack, set the stack ID. For a standalone switch, keep the default value, 1.	atFilev2SourceStackId	{ atFilev2Operation 1 }	<stack-id>
2. If the destination device is part of a stack, set the stack ID.	atFilev2DestinationStackId	{ atFilev2Operation 4 }	<stack-id>
3. Set the source device.	atFilev2SourceDevice	{ atFilev2Operation 2 }	1 (TFTP) or 2 (Flash)
4. Set the destination device.	atFilev2DestinationDevice	{ atFilev2Operation 5 }	1 (TFTP) or 2 (Flash)
5. Set the source filename. Include the path (if any) but not the device.	atFilev2SourceFileName	{ atFilev2Operation 3 }	<source-filename> e.g. /awp/config/ admin.cfg
6. Set the destination filename. Include the path (if any) but not the device.	atFilev2DestinationFileName	{ atFilev2Operation 6 }	<dest-filename> e.g. /config/admin.cfg
7. Set the IP address of the TFTP server.	atFilev2TftpIPAddr	{ atFilev2Tftp_4 1 }	<ip-addr>
8. Check that no other transfer is in progress, and that the required parameters have been set.	atFilev2CopyBegin	{ atFilev2Operation 7 }	Read: idle
9. Start the file transfer.	atFilev2CopyBegin	{ atFilev2Operation 7 }	Set: 1
10. Monitor file transfer progress.	atFilev2CopyBegin	{ atFilev2Operation 7 }	Read: In progress: copying <src> --> <dst> or Success: copy <src> --> <dst> success or Failure: copy <src> --> <dst> failure: <err-msg>

Upgrade Software and Configuration Files

Use this procedure to upgrade to a new software version and boot configuration file. For detailed descriptions of the MIB objects used in this procedure, and other MIB objects for managing software installation and configuration files, see “AT-SETUP-MIB” on page 79.36.

Table 77-2: Procedure for upgrading to a new software version and boot configuration

Do this ...	By reading or setting this MIB object ...	Whose object ID is ...	To this value...
1. Check that you have enough flash memory for the currently running software file, the new software version file, and any configuration scripts required.			
2. Check the version and name of the software currently running.	currSoftVersion currSoftName	1.3.6.1.4.1.207.8.4.4.4.500.2.1.1 1.3.6.1.4.1.207.8.4.4.4.500.2.1.2	Read: <software-name> <software-version>
3. If you do not already have the currently running software as a software version file in flash, save the currently running software with a file name to the flash root.	currSoftSaveAs	1.3.6.1.4.1.207.8.4.4.4.500.2.1.1	Set: <backup-filename.rel>
4. Check that the file saved successfully. (The most common failures result from lack of flash memory space.)	currSoftSaveAs	1.3.6.1.4.1.207.8.4.4.4.500.2.1.3	Read: saving <filename> or <filename> success or <filename> failure: <error-message>
5. Copy the new software version file to flash memory on the device	See Table 77-1.		
6. Set the new release file to be the current release that the device will install and run the next time it restarts. Include the path.	nextBootPath	1.3.6.1.4.1.207.8.4.4.4.500.2.2.2	Set: <next-filename> e.g.: flash: / release.rel
7. Check the version of release file set to install next.	nextBootVersion	1.3.6.1.4.1.207.8.4.4.4.500.2.2.1	Read: <software-version>
8. Set the previous release file to be the backup release that the device will install and run if the device fails to boot successfully with the new release file. Include the path.	bckpPath	1.3.6.1.4.1.207.8.4.4.4.500.2.3.2	Set: <backup-filename> e.g.: flash: / release.rel

Table 77-2: Procedure for upgrading to a new software version and boot configuration (cont.)

	Do this ...	By reading or setting this MIB object ...	Whose object ID is ...	To this value...
9.	Check the version of backup release file.	bckpVersion	1.3.6.1.4.1.207.8.4.4.4.500.2.3.1	Read: <software-version>
10.	If necessary, copy a configuration file to the device (Table 77-1), or save the current running configuration to a file in the root directory of flash. To save the running configuration, specify the filename, but not a device or path.	See Table 77-1. or runCnfgSaveAs	1.3.6.1.4.1.207.8.4.4.4.500.3.1.1	Set: <filename.cfg> e.g.: myconfig.cfg
11.	Check and if necessary set the file the device will use for configuration when it restarts. Include the full path.	bootCnfgPath	1.3.6.1.4.1.207.8.4.4.4.500.3.2.1	Read/set: <filename.cfg> e.g.: flash:/myconfig.cfg
12.	Check that a boot configuration file matching the boot configuration path exists.	bootCnfgExists	1.3.6.1.4.1.207.8.4.4.4.500.3.2.2	Read: TRUE (1) or FALSE (2)
13.	Check that the default configuration file flash:/default.cfg exists.	dfltCnfgExists	1.3.6.1.4.1.207.8.4.4.4.500.3.3.2	Read: TRUE (1) or FALSE (2)
14.	Restart the device.	restartDevice	1.3.6.1.4.1.207.8.4.4.4.500.1	1

Chapter 78: SNMP Commands



Command List	78.2
debug snmp	78.2
show counter snmp-server	78.3
show debugging snmp	78.6
show running-config snmp	78.6
show snmp-server	78.7
show snmp-server community	78.7
show snmp-server group	78.8
show snmp-server user	78.8
show snmp-server view	78.9
snmp trap link-status	78.10
snmp trap link-status suppress	78.11
snmp-server	78.13
snmp-server community	78.14
snmp-server contact	78.15
snmp-server enable trap	78.16
snmp-server engineID local	78.18
snmp-server group	78.19
snmp-server host	78.20
snmp-server location	78.22
snmp-server source-interface	78.23
snmp-server user	78.24
snmp-server view	78.26
undebug snmp	78.26

Command List

This chapter provides an alphabetical reference for commands used to configure SNMP. For more information, see [Chapter 77, SNMP Introduction](#), and [Chapter 79, SNMP MIBs](#).

For information about modifying or redirecting the output from **show** commands to a file, see [“Controlling “show” Command Output” on page 1.35](#).

debug snmp

This command enables SNMP debugging.

The **no** variant of this command disables SNMP debugging.

Syntax `debug snmp`

`no debug snmp`

Mode Privileged Exec and Global Configuration

Example To start SNMP debugging, use the command:

```
awplus# debug snmp
```

Related Commands [show debugging snmp](#)
[undebug snmp](#)

show counter snmp-server

This command displays counters for SNMP messages received by the SNMP agent.

Syntax `show counter snmp-server`

Mode User Exec and Privileged Exec

Example To display the counters for the SNMP agent, use the command:

```
awplus# show counter snmp-server
```

Output Figure 78-1: Example output from the `show counter snmp-server` command

```
SNMP-SERVER counters
inPkts                ..... 11
inBadVersions         ..... 0
inBadCommunityNames  ..... 0
inBadCommunityUses   ..... 0
inASNParseErrs       ..... 0
inTooBig              ..... 0
inNoSuchNames        ..... 0
inBadValues          ..... 0
inReadOnly           ..... 0
inGenErrs            ..... 0
inTotalReqVars       ..... 9
inTotalSetVars       ..... 0
inGetRequests        ..... 2
inGetNexts           ..... 9
inSetRequests        ..... 0
inGetResponses       ..... 0
inTraps              ..... 0
outPkts              ..... 11
outTooBig            ..... 0
outNoSuchNames       ..... 2
outBadValues         ..... 0
outGenErrs           ..... 0
outGetRequests       ..... 0
outGetNexts          ..... 0
outSetRequests       ..... 0
outGetResponses      ..... 11
outTraps             ..... 0
UnsupportedSecLevels ..... 0
NotInTimeWindows     ..... 0
UnknownUserNames     ..... 0
UnknownEngineIDs     ..... 0
WrongDigest          ..... 0
DecryptionErrors     ..... 0
UnknownSecModels     ..... 0
InvalidMsgs          ..... 0
UnknownPDUHandlers   ..... 0
```

Table 78-1: Parameters in the output of the **show counter snmp-server** command

Parameter	Meaning
<code>inPkts</code>	The total number of SNMP messages received by the SNMP agent.
<code>inBadVersions</code>	The number of messages received by the SNMP agent for an unsupported SNMP version. It drops these messages. The SNMP agent on your device supports versions 1, 2C, and 3.
<code>inBadCommunityNames</code>	The number of messages received by the SNMP agent with an unrecognized SNMP community name. It drops these messages.
<code>inBadCommunityUses</code>	The number of messages received by the SNMP agent where the requested SNMP operation is not permitted from SNMP managers using the SNMP community named in the message.
<code>inASNParseErrs</code>	The number of ASN.1 or BER errors that the SNMP agent has encountered when decoding received SNMP Messages.
<code>inTooBig</code>	The number of SNMP PDUs received by the SNMP agent where the value of the error-status field is 'tooBig'. This is sent by an SNMP manager to indicate that an exception occurred when processing a request from the agent.
<code>inNoSuchNames</code>	The number of SNMP PDUs received by the SNMP agent where the value of the error-status field is 'noSuchName'. This is sent by an SNMP manager to indicate that an exception occurred when processing a request from the agent.
<code>inBadValues</code>	The number of SNMP PDUs received by the SNMP agent where the value of the error-status field is 'badValue'. This is sent by an SNMP manager to indicate that an exception occurred when processing a request from the agent.
<code>inReadOnly</code>	The number of valid SNMP PDUs received by the SNMP agent where the value of the error-status field is 'readOnly'. The SNMP manager should not generate a PDU which contains the value 'readOnly' in the error-status field. This indicates that there is an incorrect implementations of the SNMP.
<code>inGenErrs</code>	The number of SNMP PDUs received by the SNMP agent where the value of the error-status field is 'genErr'.
<code>inTotalReqVars</code>	The number of MIB objects that the SNMP agent has successfully retrieved after receiving valid SNMP Get-Request and Get-Next PDUs.
<code>inTotalSetVars</code>	The number of MIB objects that the SNMP agent has successfully altered after receiving valid SNMP Set-Request PDUs.
<code>inGetRequests</code>	The number of SNMP Get-Request PDUs that the SNMP agent has accepted and processed.
<code>inGetNexts</code>	The number of SNMP Get-Next PDUs that the SNMP agent has accepted and processed.
<code>inSetRequests</code>	The number of SNMP Set-Request PDUs that the SNMP agent has accepted and processed.
<code>inGetResponses</code>	The number of SNMP Get-Response PDUs that the SNMP agent has accepted and processed.
<code>inTraps</code>	The number of SNMP Trap PDUs that the SNMP agent has accepted and processed.
<code>outPkts</code>	The number of SNMP Messages that the SNMP agent has sent.
<code>outTooBig</code>	The number of SNMP PDUs that the SNMP agent has generated with the value 'tooBig' in the error-status field. This is sent to the SNMP manager to indicate that an exception occurred when processing a request from the manager.

Table 78-1: Parameters in the output of the `show counter snmp-server` command (cont.)

Parameter	Meaning
<code>outNoSuchNames</code>	The number of SNMP PDUs that the SNMP agent has generated with the value 'noSuchName' in the error-status field. This is sent to the SNMP manager to indicate that an exception occurred when processing a request from the manager.
<code>outBadValues</code>	The number of SNMP PDUs that the SNMP agent has generated with the value 'badValue' in the error-status field. This is sent to the SNMP manager to indicate that an exception occurred when processing a request from the manager.
<code>outGenErrs</code>	The number of SNMP PDUs that the SNMP agent has generated with the value 'genErr' in the error-status field. This is sent to the SNMP manager to indicate that an exception occurred when processing a request from the manager.
<code>outGetRequests</code>	The number of SNMP Get-Request PDUs that the SNMP agent has generated.
<code>outGetNexts</code>	The number of SNMP Get-Next PDUs that the SNMP agent has generated.
<code>outSetRequests</code>	The number of SNMP Set-Request PDUs that the SNMP agent has generated.
<code>outGetResponses</code>	The number of SNMP Get-Response PDUs that the SNMP agent has generated.
<code>outTraps</code>	The number of SNMP Trap PDUs that the SNMP agent has generated.
<code>UnsupportedSecurityLevels</code>	The number of received packets that the SNMP agent has dropped because they requested a securityLevel unknown or not available to the SNMP agent.
<code>NotInTimeWindows</code>	The number of received packets that the SNMP agent has dropped because they appeared outside of the authoritative SNMP agent's window.
<code>UnknownUserNames</code>	The number of received packets that the SNMP agent has dropped because they referenced an unknown user.
<code>UnknownEngineIDs</code>	The number of received packets that the SNMP agent has dropped because they referenced an unknown snmpEngineID.
<code>WrongDigest</code>	The number of received packets that the SNMP agent has dropped because they didn't contain the expected digest value.
<code>DecryptionErrors</code>	The number of received packets that the SNMP agent has dropped because they could not be decrypted.
<code>UnknownSecModels</code>	The number of messages received that contain a security model that is not supported by the server. Valid for SNMPv3 messages only.
<code>InvalidMsgs</code>	The number of messages received where the security model is supported but the authentication fails. Valid for SNMPv3 messages only.
<code>UnknownPDUHandles</code>	The number of times the SNMP handler has failed to process a PDU. This is a system debugging counter.

Related Commands `show snmp-server`

show debugging snmp

This command displays whether SNMP debugging is enabled or disabled.

Syntax `show debugging snmp`

Mode Privileged Exec

Example To display the status of SNMP debugging, use the command:

```
awplus# show debugging snmp
```

Output Figure 78-2: Example output from the `show debugging snmp` command

```
Snmp (SMUX) debugging status:  
Snmp debugging is on
```

Related Commands [debug snmp](#)

show running-config snmp

This command displays the current configuration of SNMP on your device.

Syntax `show running-config snmp`

Mode Privileged Exec

Example To display the current configuration of SNMP on your device, use the command:

```
awplus# show running-config snmp
```

Output Figure 78-3: Example output from the `show running-config snmp` command

```
snmp-server contact AlliedTelesis  
snmp-server location Philippines  
snmp-server group grou1 auth read view1 write view1 notify view1  
snmp-server view view1 1 included  
snmp-server community public  
snmp-server user user1 group1 auth md5 password priv des password
```

Related Commands [show snmp-server](#)

show snmp-server

This command displays the status and current configuration of the SNMP server.

Syntax `show snmp-server`

Mode User Exec and Privileged Exec

Example To display the status of the SNMP server, use the command:

```
awplus# show snmp-server
```

Output Figure 78-4: Example output from the `show snmp-server` command

```
SNMP Server ..... Enabled
IP Protocol ..... IPv4,IPv6
SNMPv3 Engine ID (configured) ..... Not set
SNMPv3 Engine ID (actual)..... 0x80001f888029af52e149198483
```

Related Commands `debug snmp`
`show counter snmp-server`
`snmp-server`

show snmp-server community

This command displays the SNMP server communities configured on the device. SNMP communities are specific to v1 and v2c.

Syntax `show snmp-server community`

Mode User Exec and Privileged Exec

Example To display the SNMP server communities, use the command:

```
awplus# show snmp-server community
```

Output Figure 78-5: Example output from the `show snmp-server community` command

```
SNMP community information:
Community Name ..... public
Access ..... Read-only
View ..... none
```

Related Commands `show snmp-server`
`snmp-server community`

show snmp-server group

This command displays information about SNMP server groups. This command is used with SNMP version 3 only.

Syntax `show snmp-server group`

Mode User Exec and Privileged Exec

Example To display the SNMP groups configured on the device, use the command:

```
awplus# show snmp-server group
```

Output Figure 78-6: Example output from the `show snmp-server group` command

```
SNMP group information:
  Group name ..... guireadgroup
  Security Level ..... priv
  Read View ..... guiview
  Write View ..... none
  Notify View ..... none

  Group name ..... guiwritegroup
  Security Level ..... priv
  Read View ..... none
  Write View ..... guiview
  Notify View ..... none
```

Related Commands `show snmp-server`
`snmp-server group`

show snmp-server user

This command displays the SNMP server users and is used with SNMP version 3 only.

Syntax `show snmp-server user`

Mode User Exec and Privileged Exec

Example To display the SNMP server users configured on the device, use the command:

```
awplus# show snmp-server user
```

Output Figure 78-7: Example output from the `show snmp-server user` command

Name	Group name	Auth	Privacy
-----	-----	-----	-----
freddy	guireadgroup	none	none

Related Commands `show snmp-server`
`snmp-server user`

show snmp-server view

This command displays the SNMP server views and is used with SNMP version 3 only.

Syntax `show snmp-server view`

Mode User Exec and Privileged Exec

Example To display the SNMP server views configured on the device, use the command:

```
awplus# show snmp-server view
```

Output Figure 78-8: Example output from the `show snmp-server view` command

```
SNMP view information:
View Name ..... view1
OID ..... 1
Type ..... included
```

Related Commands `show snmp-server`
`snmp-server view`

snmp trap link-status

Use this command to enable SNMP to send link status notifications (traps) for the interfaces when an interface goes up (linkUp) or down (linkDown).

Use the **no** variant of this command to disable the sending of link status notifications.

Syntax `snmp trap link-status`
`no snmp trap link-status`

Default By default, link status notifications are disabled.

Mode Interface Configuration

Usage The link status notifications can be enabled for the following interface types:

- switch port (e.g. port 1.0.1)
- VLAN (e.g. vlan2)
- Ethernet (e.g. eth0)
- static and dynamic link aggregation (e.g. sa2, po3)

To specify where notifications are sent, use the [snmp-server host command on page 78.20](#). To configure the switch globally to send other notifications, use the [snmp-server enable trap command on page 78.16](#).

Examples To enable SNMP to send link status notifications for ports 1.0.2 to 1.0.12, use following commands:

```
awplus# configure terminal
awplus(config)# interface 1.0.2-1.0.12
awplus(config-if)# snmp trap link-status
```

To disable the sending of link status notifications for port 1.0.2, use following commands:

```
awplus# configure terminal
awplus(config)# interface 1.0.2
awplus(config-if)# no snmp trap link-status
```

Related Commands [show interface](#)
[snmp trap link-status suppress](#)
[snmp-server enable trap](#)
[snmp-server host](#)

snmp trap link-status suppress

Use this command to enable the suppression of link status notifications (traps) for the interfaces beyond the specified threshold, in the specified interval.

Use the **no** variant of this command to disable the suppression of link status notifications for the ports.

Syntax

```
snmp trap link-status suppress
    {time {<1-60>|default}|threshold {<1-20>|default}}
```

```
no snmp trap link-status suppress
```

Parameter	Description
time	Set the suppression timer for link status notifications.
<1-60>	The suppress time in seconds.
default	The default suppress time in seconds (60).
threshold	Set the suppression threshold for link status notifications. This is the number of link status notifications after which to suppress further notifications within the suppression timer interval.
<1-20>	The number of link status notifications.
default	The default number of link status notifications (20).

Default By default, if link status notifications are enabled (they are enabled by default), the suppression of link status notifications is enabled: notifications that exceed the notification threshold (default 20) within the notification timer interval (default 60 seconds) are not sent.

Mode Interface Configuration

Usage An unstable network can generate many link status notifications. When notification suppression is enabled, a suppression timer is started when the first link status notification of a particular type (linkUp or linkDown) is sent for an interface. If the threshold number of notifications of this type is sent before the timer reaches the suppress time, any further notifications of this type generated for the interface during the interval are not sent. At the end of the interval, the sending of link status notifications resumes, until the threshold is reached in the next interval.

Examples To enable the suppression of link status notifications for ports 1.0.2 to 1.0.12 after 10 notifications have been sent in 40 seconds, use following commands:

```
awplus# configure terminal
awplus(config)# interface 1.0.2-1.0.12
awplus(config-if)# snmp trap link-status suppress time 40
                    threshold 10
```

To disable the suppression link status notifications for port 1.0.2, use following commands:

```
awplus# configure terminal
awplus(config)# interface 1.0.2
awplus(config-if)# no snmp trap link-status suppress
```

Related Commands [show interface](#)
[snmp trap link-status](#)

snmp-server

Use this command to enable the SNMP agent (server) on the switch. The SNMP agent receives and processes SNMP packets sent to the switch, and generates notifications (traps) that have been enabled by the [snmp-server enable trap command on page 78.16](#).

Use the **no** variant of this command to disable the SNMP agent on the switch. When SNMP is disabled, SNMP packets received by the switch are discarded, and no notifications are generated. This does not remove any existing SNMP configuration.

Syntax `snmp-server [ip|ipv6]`
`no snmp-server [ip|ipv6]`

Parameter	Description
<code>ip</code>	Enable or disable the SNMP agent for IPv4.
<code>ipv6</code>	Enable or disable the SNMP agent for IPv6.

Default By default, the SNMP agent is enabled for both IPv4 and IPv6. If neither the **ip** parameter nor the **ipv6** parameter is specified for this command, then SNMP is enabled or disabled for both IPv4 and IPv6.

Mode Global Configuration

Examples To enable SNMP on the switch for both IPv4 and IPv6, use the commands:

```
awplus# configure terminal
awplus(config)# snmp-server
```

To enable the SNMP agent for IPv4 on the device, use the commands:

```
awplus# configure terminal
awplus(config)# snmp-server ip
```

To disable the SNMP agent for both IPv4 and IPv6 on the switch, use the commands:

```
awplus# configure terminal
awplus(config)# no snmp-server
```

To disable the SNMP agent for IPv6, use the commands:

```
awplus(config)# no snmp-server ipv6
```

Related Commands [show snmp-server](#)
[show snmp-server community](#)
[show snmp-server user](#)
[snmp-server community](#)
[snmp-server contact](#)
[snmp-server enable trap](#)
[snmp-server engineID local](#)

[snmp-server group](#)
[snmp-server host](#)
[snmp-server location](#)
[snmp-server view](#)

snmp-server community

This command creates an SNMP community, optionally setting the access mode for the community. The default access mode is read only. If view is not specified, the community allows access to all the MIB objects. The SNMP communities are only valid for SNMPv1 and v2c and provide very limited security. Communities should not be used when operating SNMPv3.

The **no** variant of this command removes an SNMP community. The specified community must already exist on the device.

Syntax

```
snmp-server community <community-name>
    {view <view-name>|ro|rw|<access-list>}

no snmp-server community <community-name> [{view <view-name>|<access-
list>}]
```

Parameter	Description
<community-name>	Community name. The community name is a string up to 20 characters long and is case sensitive.
view	Configure SNMP view. If view is not specified, the community allows access to all the MIB objects.
<view-name>	View name. The view name is a string up to 20 characters long and is case sensitive.
ro	Read-only community.
rw	Read-write community.
<access-list>	<1-99> Access list number.

Mode Global Configuration

Example The following command creates an SNMP community called "public" with read only access to all MIB variables from any management station.

```
awplus# configure terminal
awplus(config)# snmp-server community public ro
```

The following command removes an SNMP community called "public"

```
awplus# configure terminal
awplus(config)# no snmp-server community public
```

Related Commands

[show snmp-server](#)
[show snmp-server community](#)
[snmp-server view](#)

snmp-server contact

This command sets the contact information for the system. The contact name is:

- displayed in the output of the `show system` command
- stored in the MIB object `sysContact`

The `no` variant of this command removes the contact information from the system.

Syntax `snmp-server contact <contact-info>`

`no snmp-server contact`

Parameter	Description
<code><contact-info></code>	The contact information for the system, from 0 to 255 characters long. Valid characters are any printable character and spaces.

Mode Global Configuration

Example To set the system contact information to "support@alliedtelesis.co.nz", use the command:

```
awplus# configure terminal
awplus(config)# snmp-server contact support@alliedtelesis.co.nz
```

Related Commands `show system`
`snmp-server location`
`snmp-server group`

snmp-server enable trap

Use this command to enable the switch to send the specified notifications (traps).

Use the **no** variant of this command to disable the sending of the specified notifications.

Syntax

```
snmp-server enable trap {[auth] [bgp] [dhcpsnooping] [epsr] [lldp]
  [loopprot] [mstp] [nsm] [ospf] [pim] [power-inline] [rmon] [vcs]
  [vrrp]}

no snmp-server enable trap {[auth] [bgp] [dhcpsnooping] [epsr] [lldp]
  [loopprot] [mstp] [nsm] [ospf] [pim] [power-inline] [rmon] [vcs]
  [vrrp]}
```

Parameter	Description
auth	Authentication failure.
bgp	BGP traps.
dhcpsnooping	DHCP snooping and ARP security traps. These notifications must also be set using the ip dhcp snooping violation command on page 68.19 , and/or the arp security violation command on page 68.3 .
epsr	EPSR traps.
lldp	Link Layer Discovery Protocol (LLDP) traps. These notifications must also be enabled using the lldp notifications command on page 81.13 , and/or the lldp med-notifications command on page 81.8 .
loopprot	Loop Protection traps.
mstp	MSTP traps.
nsm	NSM traps.
ospf	OSPF traps.
pim	PIM traps.
power-inline	Power-inline traps (Power Ethernet MIB RFC 3621).
rmon	RMON traps.
vcs	VCS traps.
vrrp	Virtual Router Redundancy (VRRP) traps.

Default By default, no notifications are generated.

Mode Global Configuration

Usage This command cannot be used to enable link status notifications globally. To enable link status notifications for particular interfaces, use the [snmp trap link-status command on page 78.10](#). To specify where notifications are sent, use the [snmp-server host command on page 78.20](#).

Examples To enable the device to send BGP and VRRP-related traps, use the following command:

```
awplus# configure terminal
awplus(config)# snmp-server enable trap bgp vrrp
```

To disable BGP traps being sent out by the device, use the following command:

```
awplus# configure terminal
awplus(config)# no snmp-server enable trap bgp
```

Related Commands [show snmp-server](#)
[show ip dhcp snooping](#)
[snmp trap link-status](#)
[snmp-server host](#)

snmp-server engineID local

Use this command to configure the SNMP engine ID. It is used with SNMP version 3 only.

Use the **no** variant of this command to set the SNMPv3 engine ID to its default value. This has the same effect as the **snmp-server engineID local default** command.

Syntax `snmp-server engineID local {<engine-id>|default}`
`no snmp-server engineID local`

Parameter	Description
<engine-id>	Specify SNMPv3 Engine ID value, a string of up to 32 characters.
default	Set SNMPv3 engine ID to the system generated value.

Mode Global Configuration

Example To set the SNMPv3 engine ID to 800000cf030000cd123456, use the following command

```
awplus# configure terminal
awplus(config)# snmp-server engineID local
800000cf030000cd123456
```

The following command sets SNMPv3 engine ID back to the default value.

```
awplus# configure terminal
awplus(config)# no snmp-server engineID local
```

Output The following example shows the engine ID values after configuration:

```
awplus(config)#snmp-server engineid local asdgdfh231234d
awplus(config)#show snmp-server
awplus(config)#exit
awplus#show snmp-server

SNMP Server ..... Enabled
IP Protocol ..... IPv4,IPv6
SNMPv3 Engine ID (configured) ..... asdgdfh231234d
SNMPv3 Engine ID (actual).....
0x80001f888029af52e149198483

awplus(config)#no snmp-server engineid local
awplus(config)#exit
awplus#show snmp-server

SNMP Server ..... Enabled
IP Protocol ..... IPv4,IPv6
SNMPv3 Engine ID (configured) ..... Not set
SNMPv3 Engine ID (actual).....
0x80001f888029af52e149198483
```

Related Commands `show snmp-server`
`snmp-server group`

snmp-server group

This command is used with SNMP version 3 only, and adds an SNMP group, optionally setting the security level and view access modes for the group. The security and access views defined for the group represent the minimum required of its users in order to gain access.

The **no** variant of this command deletes an SNMP group, and is used with SNMPv3 only. The group with the specified authentication/encryption parameters must already exist.

Syntax

```
snmp-server group <groupname> {auth|noauth|priv}
    [read <readname>|write <writename>|notify <notifysname>]
no snmp-server group <groupname> {auth|noauth|priv}
```

Parameter	Description
<groupname>	Group name. The group name is a string up to 20 characters long and is case sensitive.
auth	Authentication.
noauth	No authentication and no encryption.
priv	Authentication and encryption.
read	Configure read view.
<readname>	Read view name.
write	Configure write view.
<writename>	Write view name. The view name is a string up to 20 characters long and is case sensitive.
notify	Configure notify view.
<notifysname>	Notify view name. The view name is a string up to 20 characters long and is case sensitive.

Mode Global Configuration

Examples To add SNMP group, for ordinary users, use the following commands:

```
awplus# configure terminal
awplus(config)# snmp-server group usergroup noauth read
useraccess write useraccess
```

To delete SNMP group usergroup, use the following commands

```
awplus# configure terminal
awplus(config)# no snmp-server group usergroup noauth
```

Related Commands

- snmp-server
- show snmp-server
- show snmp-server group
- show snmp-server user

snmp-server host

This command specifies an SNMP trap host destination to which Trap or Inform messages generated by the device are sent.

For SNMP version 1 and 2c you must specify the community name parameter. For SNMP version 3, specify the authentication/encryption parameters and the user name. If the version is not specified, the default is SNMP version 1. Inform messages can be sent instead of traps for SNMP version 2c and 3.

Use the **no** variant of this command to remove an SNMP trap host. The trap host must already exist.

The trap host is uniquely identified by:

- host IP address (IPv4 or IPv6),
- inform or trap messages,
- community name (SNMPv1 or SNMP v2c) or the authentication/encryption parameters and user name (SNMP v3).

Syntax

```
snmp-server host {<ipv4-address>|<ipv6-address>} [traps] [version 1]
  <community-name>]

snmp-server host {<ipv4-address>|<ipv6-address>} [informs|traps]
  version 2c <community-name>

snmp-server host {<ipv4-address>|<ipv6-address>} [informs|traps]
  version 3 {auth|noauth|priv} <user-name>

no snmp-server host {<ipv4-address>|<ipv6-address>} [traps]
  [version 1] <community-name>

no snmp-server host {<ipv4-address>|<ipv6-address>} [informs|traps]
  version 2c <community-name>

no snmp-server host {<ipv4-address>|<ipv6-address>} [informs|traps]
  version 3 {auth|noauth|priv} <user-name>
```

Parameter	Description
host	Configure SNMP trap host.
no	Remove the specified SNMP trap host.
<ipv4-address>	IPv4 trap host address in the format A.B.C.D, for example, 192.0.2.2.
<ipv6-address>	IPv6 trap host address in the format x:x::x:x for example, 2001:db8::8a2e:7334.
informs	Send Inform messages to this host.
traps	Send Trap messages to this host (default).
version	SNMP version to use for notification messages. Default: version 1.
1	Use SNMPv1 (default).
2c	Use SNMPv2c.
3	Use SNMPv3.

Parameter (cont.)	Description (cont.)
auth	Authentication.
noauth	No authentication.
priv	Encryption.
<community-name>	The SNMPv1 or SNMPv2c community name.
<user-name>	SNMPv3 user name.

Mode Global Configuration

Examples To configure the device to send generated traps to the IPv4 host destination 192.0.2.5 with the SNMPv2c community name *public*, use the following command:

```
awplus# configure terminal
awplus(config)# snmp-server host 192.0.2.5 version 2c public
```

To configure the device to send generated traps to the IPv6 host destination 2001:db8::8a2e:7334 with the SNMPv2c community name *private*, use the following command:

```
awplus# configure terminal
awplus(config)# snmp-server host 2001:db8::8a2e:7334 version 2c
private
```

To remove a configured trap host of 192.0.2.5 with the SNMPv2c community name *public*, use the following command:

```
awplus# configure terminal
awplus(config)# no snmp-server host 192.0.2.5 version 2c public
```

Related Commands [snmp trap link-status](#)
[snmp-server enable trap](#)
[snmp-server view](#)

snmp-server location

This command sets the location of the system. The location is:

- displayed in the output of the `show system` command
- stored in the MIB object `sysLocation`

The `no` variant of this command removes the configured location from the system.

Syntax `snmp-server location <location-name>`
`no snmp-server location`

Parameter	Description
<code><location-name></code>	The location of the system, from 0 to 255 characters long. Valid characters are any printable character and spaces.

Mode Global Configuration

Example To set the location to "server room 523", use the following commands:

```
awplus# configure terminal
awplus(config)# system location server room 523
```

Related Commands `show snmp-server`
`show system`
`snmp-server contact`

snmp-server source-interface

Use this command to specify the interface that SNMP traps or informs originate from. You cannot specify an interface that does not already have an IP address assigned to the interface.

Use the **no** variant of this command to reset to the default source interface that SNMP traps or informs originate from (the Egress interface as sent from by default).

Syntax `snmp-server source-interface {traps|informs} <interface-name>`
`no snmp-server source-interface {traps|informs}`

Parameter	Description
traps	SNMP traps.
informs	SNMP informs.
<interface-name>	Interface name (with an IP address already assigned).

Default By default the source interface is the Egress interface where traps or informs were sent from.

Mode Global Configuration

Usage An SNMP trap or inform sent from an SNMP server has the notification IP address of the interface where it was sent from. Use this command to monitor notifications from an interface.

Example To set the interface that SNMP informs originate from to port 1.0.2 for inform packets, use the following commands:

```
awplus# configure terminal
awplus(config)# snmp-server source-interface informs port1.0.2
```

To reset the interface to the default source interface (the Egress interface) that SNMP traps originate from for trap packets, use the following commands:

```
awplus# configure terminal
awplus(config)# no snmp-server source-interface traps
```

Validation Commands `show running-config`

snmp-server user

Use this command to create or move users as members of specified groups. This command is used with SNMPv3 only.

The **no** variant of this command removes an SNMPv3 user. The specified user must already exist.

Syntax

```
snmp-server user <username> <groupname> [encrypted]
    [auth {md5|sha} <auth-password>]
    [priv {des|aes} <privacy-password>]

no snmp-server user <username>
```

Parameter	Description
<username>	User name. The user name is a string up to 20 characters long and is case sensitive.
<groupname>	Group name. The group name is a string up to 20 characters long and is case sensitive.
encrypted	Use the encrypted parameter when you want to enter encrypted passwords.
auth	Authentication protocol.
md5	MD5 Message Digest Algorithms.
sha	SHA Secure Hash Algorithm.
<auth-password>	Authentication password. The password is a string of 8 to 20 characters long and is case sensitive.
priv	Privacy protocol.
des	DES Data Encryption Standard.
aes	AES Advanced Encryption Standards.
<privacy-password>	Privacy password. The password is a string of 8 to 20 characters long and is case sensitive.

Mode Global Configuration

Usage Additionally this command provides the option of selecting an authentication protocol and (where appropriate) an associated password. Similarly, options are offered for selecting a privacy protocol and password.

- Note that each SNMP user must be configured on both the manager and agent entities. Where passwords are used, these passwords must be the same for both entities.
- Use the **encrypted** parameter when you want to enter already encrypted passwords in encrypted form as displayed in the running and startup configs stored on the switch. For example, you may need to move a user from one group to another group and keep the same passwords for the user instead of removing the user to apply new passwords.
- User passwords are entered using plaintext without the **encrypted** parameter and are encrypted according to the authentication and privacy protocols selected.

- User passwords are viewed as encrypted passwords in running and startup configs shown from `show running-config` and `show startup-config` commands respectively. Copy and paste encrypted passwords from running-configs or startup-configs to avoid entry errors.

Examples To add SNMP user `authuser` as a member of group `usergroup`, with authentication protocol `md5`, authentication password `Authpass`, privacy protocol `des` and privacy password `Privpass`, use the following commands

```
awplus# configure terminal
awplus(config)# snmp-server user authuser usergroup auth md5
Authpass priv des Privpass
```

Validate the user is assigned to the group using the following command:

```
awplus#show snmp-server user
Name                Group name          Auth                Privacy
-----            -
authuser            usergroup           md5                 des
```

To enter existing SNMP user `authuser` with existing passwords as a member of group `newusergroup` with authentication protocol `md5` plus the encrypted authentication password `0x1c74b9c22118291b0ce0cd883f8dab6b74`, privacy protocol `des` plus the encrypted privacy password `0x0e0133db5453ebd03822b004eeacb6608f`, use the following commands

```
awplus# configure terminal
awplus(config)# snmp-server user authuser newusergroup
encrypted auth md5
0x1c74b9c22118291b0ce0cd883f8dab6b74 priv des
0x0e0133db5453ebd03822b004eeacb6608f
```

Note  Copy and paste the encrypted passwords from the `running-config` or the `startup-config` displayed, using the `show running-config` and `show startup-config` commands respectively, into the command line to avoid key stroke errors issuing this command.

Validate the user has been moved from the first group using the following command:

```
awplus#show snmp-server user
Name                Group name          Auth                Privacy
-----            -
authuser            newusergroup       md5                 des
```

To delete SNMP user `authuser`, use the following commands:

```
awplus# configure terminal
awplus(config)# no snmp-server user authuser
```

Related Commands [show snmp-server user](#)
[snmp-server view](#)

snmp-server view

Use this command to create an SNMP view that specifies a sub-tree of the MIB. Further sub-trees can then be added by specifying a new OID to an existing view. Views can be used in SNMP communities or groups to control the remote manager's access.

Note  The object identifier must be specified in a sequence of integers separated by decimal points.

The **no** variant of this command removes the specified view on the device. The view must already exist.

Syntax `snmp-server view <view-name> <mib-name> {included|excluded}`
`no snmp-server view <view-name>`

Parameter	Description
<code><view-name></code>	SNMP server view name. The view name is a string up to 20 characters long and is case sensitive.
<code><mib-name></code>	Object identifier of the MIB.
<code>included</code>	Include this OID in the view.
<code>excluded</code>	Exclude this OID in the view.

Mode Global Configuration

Examples The following command creates a view called "loc" that includes system location mib sub-tree.

```
awplus(config)# snmp-server view loc 1.3.6.1.2.1.1.6.0 included
```

To remove the view "loc" use the following command

```
awplus(config)# no snmp-server view loc
```

Related Commands [show snmp-server view](#)
[snmp-server community](#)

undebug snmp

This command applies the functionality of the [no debug snmp command on page 78.2](#).

Chapter 79: SNMP MIBs



Introduction.....	79.2
About MIBs.....	79.2
About SNMP.....	79.2
Obtaining MIBs.....	79.2
Loading MIBs.....	79.3
Allied Telesis Enterprise MIB.....	79.5
AT-SMI-MIB.....	79.6
AT-PRODUCT-MIB.....	79.9
AT-BOARDS-MIB.....	79.10
AT-SYSINFO-MIB.....	79.12
AT-XEM-MIB.....	79.14
AT-ENVMONv2-MIB.....	79.15
AT-VCSTACK-MIB.....	79.20
AT-MIBVERSION-MIB.....	79.25
AT-USER-MIB.....	79.26
AT-RESOURCE-MIB.....	79.28
AT-LICENSE-MIB.....	79.29
AT-TRIGGER-MIB.....	79.32
AT-LOOPPROTECT-MIB.....	79.34
AT-SETUP-MIB.....	79.36
AT-DNS-CLIENT-MIB.....	79.40
AT-NTP-MIB.....	79.41
AT-EPSRv2-MIB.....	79.44
AT-DHCPSN-MIB.....	79.46
AT-FILEv2-MIB.....	79.49
AT-LOG-MIB.....	79.57
AT-IP-MIB.....	79.59
Public MIBs.....	79.61
Private MIBs.....	79.66

Introduction

This chapter describes the Management Information Bases (MIBs) and managed objects supported by the AlliedWare Plus™ Operating System. The following topics are covered:

- “Allied Telesis Enterprise MIB” on page 79.5 describes the objects implemented in the Allied Telesis Enterprise MIB
- “Public MIBs” on page 79.61 describes the public MIBs supported by the AlliedWare Plus™ Operating System, and any variations from the standard implementation.

About MIBs

A MIB is a collection of managed objects organized into a tree-like hierarchy of nodes in which the managed objects form the leaves. Within the tree, each node is identified by a non-negative integer identifier that is unique among the node's siblings. The address, or object identifier, of any node within the tree is expressed as a series of dot-delimited node identifiers that trace the path from the root of the tree to the node. For example, the object identifier for the sysDescr object is 1.3.6.1.2.1.1.1.

For more information about MIBs and the structure of management information, see [Chapter 77, SNMP Introduction](#).

About SNMP

A network management station (NMS) uses a protocol known as Simple Network Management Protocol (SNMP) to query or change the values of objects in the MIB of managed devices.

A managed device uses SNMP to respond to queries from an NMS, and to send unsolicited alerts (traps) to an NMS in response to events.

For more information about the Simple Network Management Protocol (SNMP), see [Chapter 77, SNMP Introduction](#).

For information about configuring SNMP, see [Chapter 78, SNMP Commands](#).

Obtaining MIBs

You can download MIBs from the following locations:

Download this MIB...	From this location...
Allied Telesis Enterprise MIB	The MIB files are available with the software files from the Support area at http://www.alliedtelesis.com .
Public MIBs defined in RFCs	http://www.rfc-editor.org/rfc.html
IANAifType-MIB	http://www.iana.org/assignments/ianaiftype-mib

Loading MIBs

Individual MIBs define a portion of the total MIB for a device. For example, the MAU-MIB defines objects for managing IEEE 802.3 medium attachment units (MAUs), and forms a subtree under mib-2 with the object identifier snmpDot3MauMgt (1.3.6.1.2.1.26).

All the objects within a MIB are assigned object identifiers relative to a parent object. Most MIBs import the object identifier of the parent object, along with other object identifiers, textual conventions, macros and syntax types from the MIBs where they are defined. This creates dependencies between MIBs.

Some network management stations and MIB compilers will generate errors if you load a MIB that depends on another MIB that has not already been loaded. To avoid these errors, we recommend that you load MIBs in the following order:

1. RFC 1212
RFC 1239
RFC 2257
RFC 3410
2. RFC1155-SMI (RFC 1155)
SNMPv2-SMI (RFC 2578)
SNMPv2-PDU (RFC 3416)
3. RFC1213-MIB (RFC 1213)
RFC 1215
SNMPv2-TC (RFC 2579)
SNMPv2-CONF (RFC 2580)
4. IP-MIB (RFC 2011)
TCP-MIB (RFC 2012)
UDP-MIB (RFC 2013)
IP-FORWARD-MIB (RFC 2096)
SNMP-MPD-MIB (RFC 2572)
RMON-MIB (RFC 2819)
HCNUM-TC (RFC 2856)
SNMP-FRAMEWORK-MIB (RFC 3411)
SNMP-MPD-MIB (RFC 3412)
SNMPv2-TM (RFC 3417)
SNMPv2-MIB (RFC 3418)
INET-ADDRESS-MIB (RFC 4001)
IANAifType-MIB
5. IF-MIB (RFC 2863)
SNMP-TARGET-MIB (RFC 3413)
6. SNMP-COMMUNITY-MIB (RFC 2576)
EtherLike-MIB (RFC 3635)
MAU-MIB (RFC 3636)
BRIDGE-MIB (RFC 4188)
DISMAN-PING-MIB (RFC 4560)
SNMP-NOTIFICATION-MIB (RFC 3413)
SNMP-PROXY-MIB (RFC 3413)

-
7. P-BRIDGE-MIB (RFC 2674)
Q-BRIDGE-MIB (RFC 2674)
RSTP-MIB (RFC 4318)
LLDP-MIB
LLDP-EXT-DOT1-MIB
LLDP-EXT-DOT3-MIB
LLDP-EXT-MED-MIB
POE-MIBVRRP-MIB

 8. AT-SMI-MIB

 9. AT-BOARDS-MIB
AT-PRODUCT-MIB
AT-SETUP-MIB
AT-SYSINFO-MIB
AT-TRIGGER-MIB
AT-XEM-MIB
AT-VCSTACK-MIB
AT-USER-MIB
AT-RESOURCE-MIB
AT-LICENSE-MIB
AT-LOOPPROTECT-MIB
AT-DNS-CLIENT--MIB
AT-NTP-MIB
AT-EPSRv2-MIB
AT-FILEv2-MIB
AT-LOG-MIB
AT-IP-MIB
AT-ENVMONv2-MIB
AT-MIBVERSION-MIB
AT-DHCPSN-MIB

Allied Telesis Enterprise MIB

The *Allied Telesis Enterprise MIB* defines a portion of the Management Information Base (MIB) for managing Allied Telesis products and features that are not supported by public MIBs. Objects defined in this MIB reside in the private(4) subtree and have the object identifier alliedTelesis ({ enterprises 207 }).

This document describes only those portions of the Allied Telesis Enterprise MIB supported by the AlliedWare Plus™ Operating System. **Figure 79-1** shows the structure of the Allied Telesis Enterprise MIB. Each component MIB is detailed in the following sections of this chapter.

Figure 79-1: The Allied Telesis Enterprise MIB sub-tree of the Internet-standard Management Information Base (MIB)

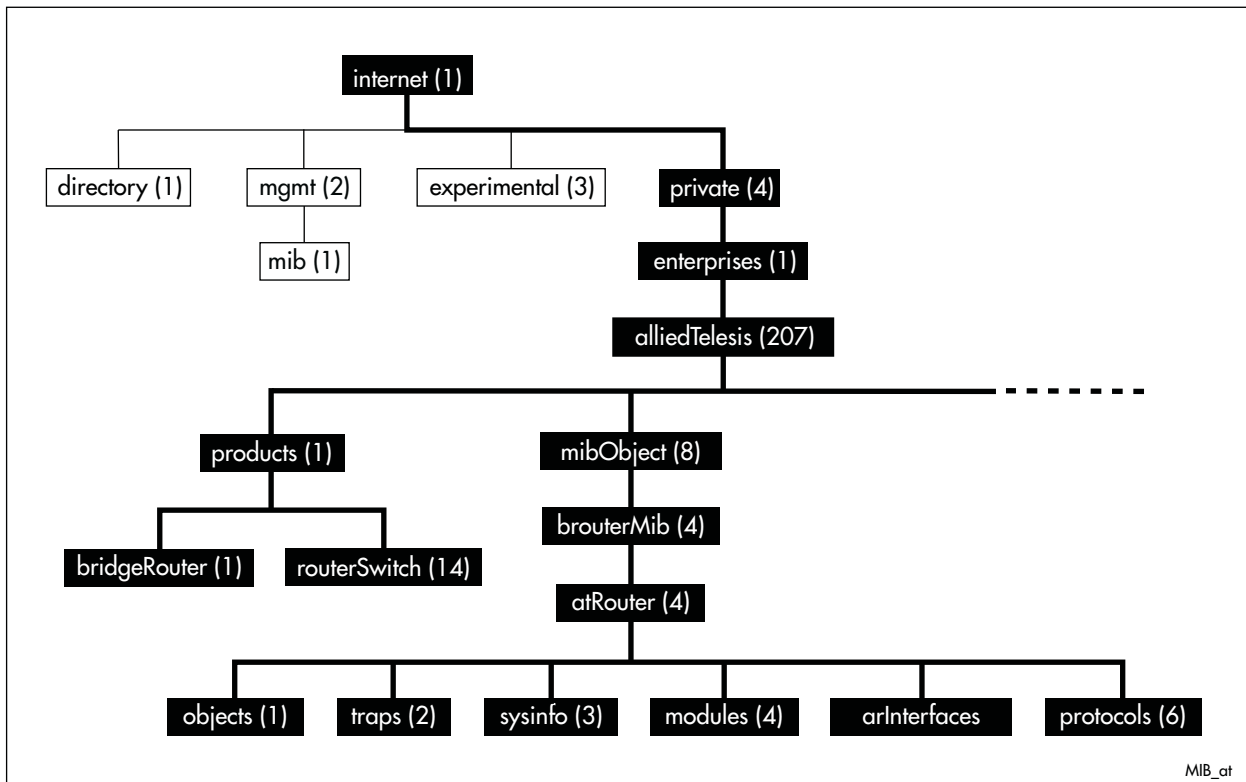

AT-SMI-MIB

AT-SMI-MIB defines the high-level structure and root objects of the Allied Telesis Enterprise MIB (Table 79-1). These objects are imported by other component MIBs of the Allied Telesis Enterprise MIB.

Table 79-1: AT Enterprise MIB - High Level Structure

Object	Object Identifier	Description
alliedTelesis	{ enterprises 207 } 1.3.6.1.4.1.207	Root of the Allied Telesis Enterprise MIB under the private(4) node defined in RFC1155-SMI.
products	{ alliedTelesis 1 } 1.3.6.1.4.1.207.1	Sub-tree of all product OIDs. Described in AT-PRODUCT-MIB
bridgeRouter	{ products 1 } 1.3.6.1.4.1.207.1.1	Sub-tree of bridge product MIB objects (not applicable for AlliedWare Plus).
routerSwitch	{ products 14 } 1.3.6.1.4.1.207.1.2	Sub-tree for all router and switch product MIB objects.
mibObject	{ alliedTelesis 8 } 1.3.6.1.4.1.207.8	Sub-tree for all managed objects.
brouterMib	{ mibObject 4 } 1.3.6.1.4.1.207.8.4	Sub-tree of objects for managing bridges, routers, and switches.
atRouter	{ brouterMib 4 } 1.3.6.1.4.1.207.8.4.4	Sub-tree of objects for managing multiprotocol routers and switches.
objects	{ atRouter 1 } 1.3.6.1.4.1.207.8.4.4.1	Sub-tree of OIDs for boards, releases, interface types, and chips.
traps	{ atRouter 2 } 1.3.6.1.4.1.207.8.4.4.2	Sub-tree for generic traps.
sysinfo	{ atRouter 3 } 1.3.6.1.4.1.207.8.4.4.3	Sub-tree of objects describing general system information.
modules	{ atRouter 4 } 1.3.6.1.4.1.207.8.4.4.4	Sub-tree of objects for monitoring and managing software features.
arInterfaces	{ atRouter 5 } 1.3.6.1.4.1.207.8.4.4.5	Sub-tree of objects describing boards, slots and physical interfaces.
protocols	{ atRouter 6 } 1.3.6.1.4.1.207.8.4.4.6	Sub-tree of OIDs for protocols.
atAgents	{ atRouter 7 } 1.3.6.1.4.1.207.8.4.4.7	Sub-tree of objects describing variations from standards.

Table 79-2 lists the major modules of the AT-SMI-MIB grouped by their object identifiers. Note that this is also the order in which they are described in this chapter.

Table 79-2: AT-SMI-MIBs Listed by Object Group

MIB Section	OID	Description
AT-SMI-MIB		This section describes the structure of management information for the Allied Telesis Enterprise object, alliedTelesis { 1.3.6.1.4.1.207 }
AT-PRODUCT-MIB	1.3.6.1.4.1.207.1	Object identifiers for Allied Telesis products. See "AT-PRODUCT-MIB" on page 79.9
AT-BOARDS-MIB	1.3.6.1.4.1.207.8.4.4.1.1	Object identifiers for boards, interface types, and chip sets. See "AT-BOARDS-MIB" on page 79.10
AT-SYSINFO-MIB	1.3.6.1.4.1.207.8.4.4.3	Objects that describe generic system information and environmental monitoring. See "AT-SYSINFO-MIB" on page 79.12
AT-XEM-MIB	1.3.6.1.4.1.207.8.4.4.3.11	Objects for managing XEMs (Expansion Modules). See "AT-XEM-MIB" on page 79.14
AT-ENVMONv2-MIB	1.3.6.1.4.1.207.8.4.4.3.12	Objects and traps for monitoring fans, voltage rails, temperature sensors, and power supply bays. See "AT-ENVMONv2-MIB" on page 79.15
AT-VCSTACK-MIB	1.3.6.1.4.1.207.8.4.4.3.13	Objects for managing Virtual Chassis Stacking (VCS). See "AT-VCSTACK-MIB" on page 79.20
AT-MIBVERSION-MIB	1.3.6.1.4.1.207.8.4.4.3.15	Object to display the last software release that contained changes to the support AT Enterprise MIB definition files. See "AT-MIBVERSION-MIB" on page 79.25 .
AT-USER-MIB	1.3.6.1.4.1.207.8.4.4.3.20	Objects for displaying information of users currently logged into a device, or configured in the Local User Data base of the device. See "AT-USER-MIB" on page 79.26
AT-RESOURCE-MIB	1.3.6.1.4.1.207.8.4.4.3.21	Objects for displaying system hardware resource information. See "AT-RESOURCE-MIB" on page 79.28
AT-LICENSE-MIB	1.3.6.1.4.1.207.8.4.4.3.22	Objects for managing software licenses on devices using AlliedWare Plus™ Operating System. See "AT-LICENSE-MIB" on page 79.29
AT-TRIGGER-MIB	1.3.6.1.4.1.207.8.4.4.4.53	Objects for managing triggers. See "AT-TRIGGER-MIB" on page 79.32
AT-LOOPPROTECT-MIB	1.3.6.1.4.1.207.8.4.4.4.54	Objects for managing Allied Telesis Loop Protection. See "AT-LOOPPROTECT-MIB" on page 79.34
AT-SETUP-MIB	1.3.6.1.4.1.207.8.4.4.4.500	Objects for managing software installation and configuration files. See "AT-SETUP-MIB" on page 79.36
AT-DNS-CLIENT-MIB	1.3.6.1.4.1.207.8.4.4.4.501	Objects for managing Allied Telesis DNS Client Configuration. See "AT-DNS-CLIENT-MIB" on page 79.40
AT-NTP-MIB	1.3.6.1.4.1.207.8.4.4.4.502	Objects for managing Allied Telesis Network Time Protocol (NTP) configuration. See "AT-NTP-MIB" on page 79.41
AT-EPSRv2-MIB	1.3.6.1.4.1.207.8.4.4.4.536	Objects for managing Allied Telesis EPSR. See "AT-EPSRv2-MIB" on page 79.44
AT-DHCPSN-MIB	1.3.6.1.4.1.207.8.4.4.4.537	Objects for managing Allied Telesis DHCP Snooping. See "AT-DHCPSN-MIB" on page 79.46
AT-FILEv2-MIB	1.3.6.1.4.1.207.8.4.4.4.600	Objects for displaying and managing file content on local, stacked and remote sources. See "AT-FILEv2-MIB" on page 79.49

Table 79-2: AT-SMI-MIBs Listed by Object Group (cont.)

MIB Section	OID	Description
AT-LOG-MIB	1.3.6.1.4.1.207.8.4.4.4.601	Objects for listing log entries from the buffered and permanent logs. See "AT-LOG-MIB" on page 79.57
AT-IP-MIB	1.3.6.1.4.1.207.8.4.4.4.602	Objects for Allied Telesis specific IP address management. See "AT-IP-MIB" on page 79.59

AT-PRODUCT-MIB

AT-PRODUCT-MIB defines object identifiers for Allied Telesis products. Objects in this MIB have the object identifier products ({ alliedTelesis 1 }). [Table 79-3](#) lists object identifiers for products supported by the AlliedWare Plus™ Operating System.

Table 79-3: Object identifiers for Allied Telesis products supported by the AlliedWare Plus™ Operating System

Object	Object Identifier	Description
routerSwitch	{ products 14 }	Switch products
at_SwitchBladex908	{ routerSwitch 69 }	Switchblade x908 8 Slot Layer 3 Switch Chassis
at_x900_12XTS	{ routerSwitch 70 }	AT-x900-12XT/S Advanced Gigabit Layer 3+ Expandable Switch, 12 x combo ports (10/100/1000BASE-T copper or SFP), 1 x 30Gbps expansion bay
at_x900_24XT	{ routerSwitch 75 }	x900-24XT Enhanced Gigabit Layer 3+ Expandable Switch, 24 x 10/100/1000BASE-T copper ports (RJ-45 connectors), 2 x 20 Gigabit expansion bays
at_x900_24XS	{ routerSwitch 76 }	x900-24XS Enhanced Gigabit Layer 3+ Expandable Switch, 24 x 10/100/1000BASE-T copper ports (RJ-45 connectors), 2 x 20 Gigabit expansion bays
at_x900_24XT_N	{ routerSwitch 77 }	x900-24XT-N Enhanced Gigabit Layer 3+ Expandable Switch, 24 x 10/100/1000BASE-T copper ports (RJ-45 connectors), 2 x 20 Gigabit expansion bays, NEBS compliant
at_x600_24Ts	{ routerSwitch 80 }	x600-24Ts Stackable Managed L2+/L3 Ethernet Switch, 24 x 1000BASE-T ports, 4 x SFP (combo) ports
at_x600_24TsXP	{ routerSwitch 81 }	x600-24Ts/XP Stackable Managed L2+/L3 Ethernet Switch, 24 x 1000BASE-T ports, 4 x SFP (combo) ports, 2 x XFP ports
at_x600_48Ts	{ routerSwitch 82 }	x600-48Ts Stackable Managed L2+/L3 Ethernet Switch, 48 x 1000BASE-T ports, 4 x SFP ports
at_x600_48TsXP	{ routerSwitch 83 }	x600-48Ts/XP Stackable Managed L2+/L3 Ethernet Switch, 48 x 1000BASE-T ports, 4 x SFP ports, 2 x XFP ports
at_x600-24TsPoE	{ routerSwitch 91 }	x600-24Ts-POE Stackable Managed L2+/L3 Ethernet PoE Switch, 24 x 1000BASE-T PoE ports, 4 x SFP (combo) ports

AT-BOARDS-MIB

AT-BOARDS-MIB defines object identifiers for components of Allied Telesis products—base CPU and expansion boards, interface types, and chip sets. Objects in this MIB have the object identifier objects ({ atRouter 1 }), and are organized into the following groups:

- Base CPU and expansion boards (Table 79-4). These object identifiers are for use with the hrDeviceID object in the Host Resources MIB (see “Public MIBs” on page 79.61).
- Interface types (Table 79-5).
- Chip sets (Table 79-6).

Table 79-4: Object identifiers for base CPU and expansion boards

Object	Object Identifier	Description
boards	{ objects 1 }	
pprx90024XT	{ boards 271 }	x900-24XT Enhanced Gigabit Layer 3+ Expandable Switch, 24 x 10/100/1000BASE-T copper ports (RJ-45 connectors), 2 x 20 Gigabit expansion bays
pprx90024XS	{ boards 272 }	x900-24XS Enhanced Gigabit Layer 3+ Expandable Switch, 24 x 10/100/1000BASE-T copper ports (RJ-45 connectors), 2 x 20 Gigabit expansion bays
pprAtXum10Gi	{ boards 273 }	XEM-1XP Expansion Module, 1 x 10Gbe XFP port
pprAtXum12SFPI	{ boards 274 }	XEM-12S Expansion Module, 12 x SFP Gigabit ports
pprAtXum12Ti	{ boards 275 }	XEM-12T Expansion Module, 12 x 10/100/100BASE-T copper ports (RJ-45 connectors)
pprAtXum12TiN	{ boards 280 }	XEM-12T-N Expansion Module, 12 x 10/100/100BASE-T copper ports (RJ-45 connectors), NEBS compliant
pprx90024XTN	{ boards 281 }	x900-24XT Enhanced Gigabit Layer 3+ Expandable Switch, 24 x 10/100/1000BASE-T copper ports (RJ-45 connectors), 2 x 20 Gigabit expansion bays, NEBS compliant
pprSwitchBladex908	{ boards 282 }	Switchblade x908 8 Slot Layer 3 Switch Chassis
pprXumStk	{ boards 286 }	XEM-STK Expansion Module, 2 x stacking ports
pprx90012XTS	{ boards 288 }	AT-x900-12XT/S Advanced Gigabit Layer 3+ Expandable Switch, 12 x combo ports (10/100/1000BASE-T copper or SFP), 1 x 30Gbps expansion bay
pprAt9524TS	{ boards 290 }	x600-24Ts/XP, 24 x 1000BASE-T ports (RJ45 connectors), 4 x SFP (combo) ports
pprAt9524TSXP	{ boards 291 }	x600-24Ts/XP, 24 x 1000BASE-T ports (RJ45 connectors), 4 x SFP (combo) ports, 2 x XFP ports
pprAt9548TS	{ boards 294 }	x600-44Ts, 44 x 1000BASE-T ports, 4 x SFP ports
pprAt9548TSXP	{ boards 295 }	x600-44Ts/XP, 44 x 1000BASE-T ports, 4 x SFP ports, 2 x XFP ports
pprXem2XP	{ boards 306 }	XEM-2XP Expansion Module, 2 x 10Gbe XFP port
pprATStackXG	{ boards 307 }	x600 Expansion Module, Stacking
pprATEMXP	{ boards 308 }	x600 Expansion Module, 2 x 10G XFP ports
pprATLBM	{ boards 309 }	x600 Expansion Module, loopback
pprAtPWR05DC	{ boards 323 }	AT-PWR05 DC Power Supply Unit for SwitchBlade x908
pprXem2XT	{ boards 325 }	XEM-2XT Expansion Module, 2 x 10Gbe copper XEM port
pprx60024TSPOE	{ boards 326 }	x600-24Ts-POE, 24 x 1000BASE-T PoE ports (RJ45 connectors), 4 x SFP (combo) ports

Table 79-5: Object identifiers for interface types

Object	Object Identifier	Description
iftypes	{ objects 3 }	
ifaceEth	{ iftypes 1 }	Ethernet
ifaceSyn	{ iftypes 2 }	Synchronous
ifaceAsyn	{ iftypes 3 }	Asynchronous
ifaceBri	{ iftypes 4 }	BRI ISDN
ifacePri	{ iftypes 5 }	PRI ISDN
ifacePots	{ iftypes 6 }	POTS (voice)
ifaceGBIC	{ iftypes 7 }	GBIC (Gigabit Interface Converter)

Table 79-6: Object identifiers for chip sets

Object	Object Identifier	Description
chips	{ objects 4 }	
chip68020Cpu	{ chips 1 }	MC68020 CPU
chip68340Cpu	{ chips 2 }	MC68340 CPU
chip68302Cpu	{ chips 3 }	MC68302 CPU
chip68360Cpu	{ chips 4 }	MC68360 CPU
chip860TCpu	{ chips 5 }	MPC860T CPU
chipRtc1	{ chips 21 }	Real Time Clock v1
chipRtc2	{ chips 22 }	Real Time Clock v2
chipRtc3	{ chips 23 }	Real Time Clock v3
chipRtc4	{ chips 24 }	Real Time Clock v4
chipRam1mb	{ chips 31 }	1 MB RAM
chipRam2mb	{ chips 32 }	2 MB RAM
chipRam3mb	{ chips 33 }	3 MB RAM
chipRam4mb	{ chips 34 }	4 MB RAM
chipRam6mb	{ chips 36 }	6 MB RAM
chipRam8mb	{ chips 38 }	8 MB RAM
chipRam12mb	{ chips 42 }	12 MB RAM
chipRam16mb	{ chips 46 }	16 MB RAM
chipRam20mb	{ chips 50 }	20 MB RAM
chipRam32mb	{ chips 62 }	32 MB RAM
chipFlash1mb	{ chips 71 }	1 MB FLASH memory
chipFlash2mb	{ chips 72 }	2 MB FLASH memory
chipFlash3mb	{ chips 73 }	3 MB FLASH memory
chipFlash4mb	{ chips 74 }	4 MB FLASH memory
chipFlash6mb	{ chips 76 }	6 MB FLASH memory
chipFlash8mb	{ chips 78 }	8 MB FLASH memory
chipPem	{ chips 120 }	Processor Enhancement Module

AT-SYSINFO-MIB

AT-SYSINFO-MIB defines objects that describe generic system information and environmental monitoring. Objects in this group have the object identifier sysinfo ({ atRouter 3 }). [Table 79-7](#) lists the objects supported by the AlliedWare Plus™ Operating System.

Table 79-7: Objects defined in AT-SYSINFO-MIB

Object	Object Identifier	Description
sysinfo	{ atRouter 3 }	Subtree containing generic system information.
cpu	{ sysinfo 3 }	A collection of objects containing information about the CPU utilization over different periods of time. All values are expressed as a percentage - integer in range 0 to 100.
cpuUtilisationMax	{ cpu 1 }	Maximum CPU utilization since the device was last restarted.
cpuUtilisationAvg	{ cpu 2 }	Average CPU utilization since the device was last restarted.
cpuUtilisationAvgLastMinute	{ cpu 3 }	Average CPU utilization over the past minute.
cpuUtilisationAvgLast10Seconds	{ cpu 4 }	Average CPU utilization over the past ten seconds.
cpuUtilisationAvgLastSecond	{ cpu 5 }	Average CPU utilization over the past second.
cpuUtilisationAvgMaxLast5Minutes	{ cpu 6 }	Maximum CPU utilization over the last 5 minutes.
cpuUtilisationAvgLast5Minutes	{ cpu 7 }	Average CPU utilization over the past 5 minutes.
atContactDetails	{ sysinfo 5 }	Contact details for Allied Telesis.
memory	{ sysinfo 7 }	A collection of objects and traps for monitoring memory usage and status.
freeMemory	{ memory 1 }	Percentage of free memory still available on device.
totalBuffers	{ memory 2 }	Total number of buffers available on device.
lowMemoryTrap	{ memory 11 }	Notification of low memory, generated when a device's memory is below a certain level. Will display the values in 'freeMemory' and 'totalBuffers'
xem	{ sysinfo 11 }	A collection of objects for monitoring XEMs installed in the device. See "AT-XEM-MIB" on page 79.14
atEnvMonv2	{ sysinfo 12 }	AT Environment Monitoring v2 MIB for managing and reporting data relating to voltage rails, fan speeds, temperature sensors and power supply units. See "AT-ENVMONv2-MIB" on page 79.15
vcstack	{ sysinfo 13 }	A collection of objects for managing Virtual Chassis Stacking in AlliedWare Plus™. See "AT-VCSTACK-MIB" on page 79.20
atPortInfo	{ sysinfo 14 }	Objects containing information about the transceiver of an interface.
atPortInfoTransceiverTable	{ atPortInfo 1 }	A table containing information about the transceiver of an interface. Indexed by: <ul style="list-style-type: none"> ■ atPortInfoTransceiverifIndex

Table 79-7: Objects defined in AT-SYSINFO-MIB (cont.)

Object	Object Identifier	Description
atPortInfoTransceiverEntry	{ atPortInfoTransceiverTable 1 }	Description of a single transceiver.
atPortInfoTransceiverifIndex	{ atPortInfoTransceiverEntry 1 }	The interface index for the interface represented by this entry.
atPortInfoTransceiverType	{ atPortInfoTransceiverEntry 2 }	<p>The type of transceiver on an interface. Can be one of the following:</p> <ul style="list-style-type: none"> ■ rj45 (1) ■ sfp-px (2) ■ sfp-bx10 (3) ■ sfp-fx (4) ■ sfp-100base-lx (5) ■ sfp-t (6) ■ sfp-cx (7) ■ sfp-zx-cwdm (8) ■ sfp-lx (9) ■ sfp-sx (10) ■ sfp-oc3-lr (11) ■ sfp-oc3-ir (12) ■ sfp-oc3-mm (13) ■ xfp-srsw (14) ■ xfp-lrlw (15) ■ xfp-erew (16) ■ xfp-sr (17) ■ xfp-lr (18) ■ xfp-er (19) ■ xfp-lrm (20) ■ xfp-sw (21) ■ xfp-lw (22) ■ xfp-ew (23) ■ unknown (24) ■ empty (25)
atPortRenumEvents	{ atPortInfo 2 }	The number of times that port number values (represented by the dot1dBasePort object in BRIDGE-MIB), have been re-assigned due to stack member leave/join events or XEM hot-swap events, since the system was initialized.

AT-XEM-MIB

AT-XEM-MIB defines objects for managing XEMs (Expansion Modules) installed in the device (Table 79-8). Objects in this group have the object identifier xem ({ sysinfo 11 }) and reside in the sysinfo Group of the Allied Telesis Enterprise MIB.

Table 79-8: Objects defined in AT-XEM-MIB

Object	Object Identifier	Description
xemTraps	{ xem 0 }	Collection of traps generated when a XEM is inserted or removed.
xemInserted	{ xemTraps 1 }	Trap generated when a XEM card is inserted to the device. It returns the objects xemInfoStackId and xemInfoBayId.
xemRemoved	{ xemTraps 2 }	Trap generated when a XEM card is removed from the device. It returns the objects xemInfoStackId and xemInfoBayId.
xemInsertedFail	{ xemTraps 3 }	Trap generated when the insertion of a XEM card into the device fails. It returns the objects xemInfoStackId and xemInfoBayId.
xemNumOfXem	{ xem 1 }	Total number of XEMs installed in the device.
xemInfoTable	{ xem 2 }	Table of information about the XEMs installed in the device, indexed by xemInfoMemberId and xemInfoBayId.
xemInfoEntry	{ xemInfoTable 1 }	Information about a single XEM.
xemInfoMemberId	{ xemInfoEntry 1 }	Stack Member ID in which the XEM is installed.
xemInfoBayId	{ xemInfoEntry 2 }	Number of the XEM bay in which the XEM is installed.
xemInfoXemId	{ xemInfoEntry 3 }	Numeric board identity of the XEM. This information is displayed in the ID column of the SHOW SYSTEM command.
xemInfoBoardType	{ xemInfoEntry 4 }	Board type. For XEMs this is always "Expansion". This information is displayed in the Board column of the SHOW SYSTEM command.
xemInfoBoardName	{ xemInfoEntry 5 }	Name of the XEM. This information is displayed in the Board Name column of the SHOW SYSTEM command.
xemInfoRevision	{ xemInfoEntry 6 }	Board revision of the XEM. This information is displayed in the Rev column of the SHOW SYSTEM command.
xemInfoSerialNumber	{ xemInfoEntry 7 }	Serial number of the XEM. This information is displayed in the Serial Number column of the SHOW SYSTEM command.

AT-ENVMONv2-MIB

The AT Environment Monitoring v2 MIB (atEnvMonv2-MIB) contains objects for managing and reporting data relating to fans, voltage rails, temperature sensors and power supply units installed in the device (Table 79-9). Objects in this group have the object identifier EnvMonv2 ({ sysinfo 12 }).

Table 79-9: Objects defined in AT-ENVMONV2-MIB

Object / Object Identifier	Description
atEnvMonv2Notifications { atEnvMonv2 0 }	Collection of traps (notification) objects for monitoring fans, voltage rails, temperature sensors, and power supply bays.
atEnvMonv2FanAlarmSetNotify { atEnvMonv2Notifications 1 }	Notification generated when the monitored speed of a fan drops below its lower threshold. It returns the value of: <ul style="list-style-type: none"> ■ atEnvMonv2FanStackMemberId ■ atEnvMonv2FanBoardIndex ■ atEnvMonv2FanIndex ■ atEnvMonv2FanDescription ■ atEnvMonv2FanLowerThreshold ■ atEnvMonv2FanCurrentSpeed
atEnvMonv2FanAlarmClearedNotify { atEnvMonv2Notifications 2 }	Notification generated when the monitored speed of a fan returns to an acceptable value, the fan having previously been in an alarm condition. It returns the value of: <ul style="list-style-type: none"> ■ atEnvMonv2FanStackMemberId ■ atEnvMonv2FanBoardIndex ■ atEnvMonv2FanIndex ■ atEnvMonv2FanDescription ■ atEnvMonv2FanLowerThreshold ■ atEnvMonv2FanCurrentSpeed
atEnvMonv2VoltAlarmSetNotify { atEnvMonv2Notifications 3 }	Notification generated when the voltage of a monitored voltage rail, goes out of tolerance by either dropping below its lower threshold, or exceeding its upper threshold. It returns the value of: <ul style="list-style-type: none"> ■ atEnvMonv2VoltageStackMemberId ■ atEnvMonv2VoltageBoardIndex ■ atEnvMonv2VoltageIndex ■ atEnvMonv2VoltageDescription ■ atEnvMonv2VoltageUpperThreshold ■ atEnvMonv2VoltageLowerThreshold ■ atEnvMonv2VoltageCurrent
atEnvMonv2VoltAlarmClearedNotify { atEnvMonv2Notifications 4 }	Notification generated when the voltage of a monitored voltage rail returns to an acceptable value, having previously been in an alarm condition. It returns the value of: <ul style="list-style-type: none"> ■ atEnvMonv2VoltageStackMemberId ■ atEnvMonv2VoltageBoardIndex ■ atEnvMonv2VoltageIndex ■ atEnvMonv2VoltageDescription ■ atEnvMonv2VoltageUpperThreshold ■ atEnvMonv2VoltageLowerThreshold ■ atEnvMonv2VoltageCurrent

Table 79-9: Objects defined in AT-ENVMONV2-MIB (cont.)

Object / Object Identifier	Description
atEnvMonv2TempAlarmSetNotify { atEnvMonv2Notifications 5 }	Notification generated when a monitored temperature exceeds its upper threshold. It returns the value of: <ul style="list-style-type: none"> ■ atEnvMonv2TemperatureStackMemberId ■ atEnvMonv2TemperatureBoardIndex ■ atEnvMonv2TemperatureIndex ■ atEnvMonv2TemperatureDescription ■ atEnvMonv2TemperatureUpperThreshold ■ atEnvMonv2TemperatureCurrent
atEnvMonv2TempAlarmClearedNotify { atEnvMonv2Notifications 6 }	Notification generated when a monitored temperature returns to an acceptable value, having previously been in an alarm condition. It returns the value of: <ul style="list-style-type: none"> ■ atEnvMonv2TemperatureStackMemberId ■ atEnvMonv2TemperatureBoardIndex ■ atEnvMonv2TemperatureIndex ■ atEnvMonv2TemperatureDescription ■ atEnvMonv2TemperatureUpperThreshold
atEnvMonv2PsbAlarmSetNotify { atEnvMonv2Notifications 7 }	Notification generated when a monitored parameter of a power supply bay device goes out of tolerance. It returns the value of: <ul style="list-style-type: none"> ■ atEnvMonv2PsbSensorStackMemberId ■ atEnvMonv2PsbSensorBoardIndex ■ atEnvMonv2PsbSensorIndex ■ atEnvMonv2PsbSensorType ■ atEnvMonv2PsbSensorDescription
atEnvMonv2PsbAlarmClearedNotify { atEnvMonv2Notifications 8 }	Notification generated when a monitored parameter of a power supply bay device returns to an acceptable value, having previously been in an alarm condition. It returns the value of: <ul style="list-style-type: none"> ■ atEnvMonv2PsbSensorStackMemberId ■ atEnvMonv2PsbSensorBoardIndex ■ atEnvMonv2PsbSensorIndex ■ atEnvMonv2PsbSensorType ■ atEnvMonv2PsbSensorDescription
atEnvMonv2FanTable { EnvMonv2 1 }	Table of information about fans installed in the device that have their fan speeds monitored by environment monitoring hardware, indexed by: <ul style="list-style-type: none"> ■ atEnvMonv2FanStackMemberId ■ atEnvMonv2FanBoardIndex ■ atEnvMonv2FanIndex
atEnvMonv2FanEntry { atEnvMonv2FanTable 1 }	Description, current speed, lower threshold speed and current status of a single fan.
atEnvMonv2FanStackMemberId { atEnvMonv2FanEntry 1 }	Index of the stack member hosting this fan.
atEnvMonv2FanBoardIndex { atEnvMonv2FanEntry 2 }	Index of the board hosting this fan in the board table.
atEnvMonv2FanIndex { atEnvMonv2FanEntry 3 }	Numeric identifier of this fan on its host board.
atEnvMonv2FanDescription { atEnvMonv2FanEntry 4 }	Description of this fan.
atEnvMonv2FanCurrentSpeed { atEnvMonv2FanEntry 5 }	Current speed of this fan in revolutions per minute.

Table 79-9: Objects defined in AT-ENVMONV2-MIB (cont.)

Object / Object Identifier	Description
atEnvMonv2FanLowerThreshold { atEnvMonv2FanEntry 6 }	Minimum acceptable speed of the fan in revolutions per minute.
atEnvMonv2FanStatus { atEnvMonv2FanEntry 7 }	Whether this fan is currently in an alarm condition. The values can be: <ul style="list-style-type: none"> ■ Failed (1) means that the current speed is too low. ■ Good (2) means that the current speed is acceptable.
atEnvMonv2VoltageTable { atEnvMonv2 2 }	Table of information about voltage rails in the device that are monitored by environment monitoring hardware, indexed by: <ul style="list-style-type: none"> ■ atEnvMonv2VoltageStackMemberId ■ atEnvMonv2VoltageBoardIndex ■ atEnvMonv2VoltageIndex
atEnvMonv2VoltageEntry { atEnvMonv2VoltageTable 1 }	Description, current value, upper & lower threshold settings and current status of a single voltage rail.
atEnvMonv2VoltageStackMemberId { atEnvMonv2VoltageEntry 1 }	Index of the stack member hosting this voltage sensor.
atEnvMonv2VoltageBoardIndex { atEnvMonv2VoltageEntry 2 }	Index of the board hosting this voltage sensor in the board table.
atEnvMonv2VoltageIndex { atEnvMonv2VoltageEntry 3 }	Numeric identifier of this voltage rail on its host board.
atEnvMonv2VoltageDescription { atEnvMonv2VoltageEntry 4 }	Description of this voltage rail.
atEnvMonv2VoltageCurrent { atEnvMonv2VoltageEntry 5 }	Current reading of this voltage rail in millivolts.
atEnvMonv2VoltageUpperThreshold { atEnvMonv2VoltageEntry 6 }	Maximum acceptable reading of this voltage rail in millivolts.
atEnvMonv2VoltageLowerThreshold { atEnvMonv2VoltageEntry 7 }	Minimum acceptable reading of this voltage rail in millivolts.
atEnvMonv2VoltageStatus { atEnvMonv2VoltageEntry 8 }	Whether this voltage rail is currently in an alarm condition. Possible values are: <ul style="list-style-type: none"> ■ outOfRange (1) - means that the current reading is outside the threshold range. ■ inRange (2) - means that the current reading is acceptable.
atEnvMonv2TemperatureTable { atEnvMonv2 3 }	Table of information about temperature sensors in the device that are monitored by environment monitoring hardware, indexed by: <ul style="list-style-type: none"> ■ atEnvMonv2TemperatureStackMemberId ■ atEnvMonv2TemperatureBoardIndex ■ atEnvMonv2TemperatureIndex
atEnvMonv2TemperatureEntry { atEnvMonv2TemperatureTable 1 }	Description, current value, upper threshold setting and current status of a single temperature sensor.
atEnvMonv2TemperatureStackMemberId { atEnvMonv2TemperatureEntry 1 }	Index of the stack member hosting this temperature sensor.
atEnvMonv2TemperatureBoardIndex { atEnvMonv2TemperatureEntry 2 }	Index of the board hosting this temperature sensor in the board table.
atEnvMonv2TemperatureIndex { atEnvMonv2TemperatureEntry 3 }	Numeric identifier of this temperature sensor on its host board.
atEnvMonv2TemperatureDescription { atEnvMonv2TemperatureEntry 4 }	Description of this temperature sensor.
atEnvMonv2TemperatureCurrent { atEnvMonv2TemperatureEntry 5 }	Current reading of this temperature sensor in degrees Celsius.

Table 79-9: Objects defined in AT-ENVMONV2-MIB (cont.)

Object / Object Identifier	Description
atEnvMonv2TemperatureUpperThreshold { atEnvMonv2TemperatureEntry 6 }	Maximum acceptable reading for this temperature sensor in degrees Celsius.
atEnvMonv2TemperatureStatus { atEnvMonv2TemperatureEntry 7 }	Whether this temperature sensor is currently in an alarm condition. Can be: <ul style="list-style-type: none"> ■ outOfRange (1) - means that the current reading is outside the threshold range. ■ inRange (2) - means that the current reading is acceptable.
atEnvMonv2PsbObjects { atEnvMonv2 4 }	Collection of objects for monitoring power supply bays in the system and any devices that are installed. It contains the following objects: <ul style="list-style-type: none"> ■ atEnvMonv2PsbTable ■ atEnvMonv2PsbSensorTable
atEnvMonv2PsbTable { atEnvMonv2PsbObjects 1 }	Table of information about power supply bays in the system, indexed by: <ul style="list-style-type: none"> ■ atEnvMonv2PsbHostStackMemberId ■ atEnvMonv2PsbHostBoardIndex ■ atEnvMonv2PsbHostSlotIndex
atEnvMonv2PsbEntry { atEnvMonv2PsbTable 1 }	Description and current status of a single power supply bay device.
atEnvMonv2PsbHostStackMemberId { atEnvMonv2PsbEntry 1 }	Index of the stack member hosting this power supply bay.
atEnvMonv2PsbHostBoardIndex { atEnvMonv2PsbEntry 2 }	Index of the board hosting this power supply bay in the board table.
atEnvMonv2PsbHostSlotIndex { atEnvMonv2PsbEntry 3 }	Index of this power supply bay slot on its host board. This index is fixed for each slot, on each type of board.
atEnvMonv2PsbHeldBoardIndex { atEnvMonv2PsbEntry 4 }	Index of a board installed in this power supply bay. This value corresponds to atEnvMonv2PsbSensorBoardIndex for each sensor on this board. A value of 0 indicates that a board is either not present or not supported.
atEnvMonv2PsbHeldBoardId { atEnvMonv2PsbEntry 5 }	Type of board installed in this power supply bay. The values of this object are taken from the pprXxx object IDs under the boards sub-tree in the parent MIB. A value of 0 indicates that a board is either not present or not supported.
atEnvMonv2PsbDescription { atEnvMonv2PsbEntry 6 }	Description of this power supply bay.
atEnvMonv2PsbSensorTable { atEnvMonv2PsbObjects 2 }	Table of information about environment monitoring sensors on devices installed in power supply bays, indexed by: <ul style="list-style-type: none"> ■ atEnvMonv2PsbSensorStackMemberId ■ atEnvMonv2PsbSensorBoardIndex ■ atEnvMonv2PsbSensorIndex
atEnvMonv2PsbSensorEntry { atEnvMonv2PsbSensorTable 1 }	Description and current status of the sensor on a device installed in a power supply bay.
atEnvMonv2PsbSensorStackMemberId { atEnvMonv2PsbSensorEntry 1 }	Index of the stack member hosting this sensor.
atEnvMonv2PsbSensorBoardIndex { atEnvMonv2PsbSensorEntry 2 }	Index of the board hosting this sensor in the board table.
atEnvMonv2PsbSensorIndex { atEnvMonv2PsbSensorEntry 3 }	Index of this power supply bay environmental sensor on its host board.

Table 79-9: Objects defined in AT-ENVMONV2-MIB (cont.)

Object / Object Identifier	Description
atEnvMonv2PsbSensorType { atEnvMonv2PsbSensorEntry 4 }	Type of environmental variable this sensor detects. One of: <ul style="list-style-type: none"> ■ psbSensorTypeInvalid(0) ■ fanSpeedDiscrete(1) ■ temperatureDiscrete(2) ■ voltageDiscrete(3)
atEnvMonv2PsbSensorDescription { atEnvMonv2PsbSensorEntry 5 }	Description of this power supply bay environmental sensor.
atEnvMonv2PsbSensorStatus { atEnvMonv2PsbSensorEntry 6 }	Whether this environmental sensor is currently in an alarm condition. One of: <ul style="list-style-type: none"> ■ failed (1) - means that the device is in a failure condition ■ good(2) - means that the device is functioning normally. ■ notPowered (3) - a PSU is installed, but not powered up
atEnvMonv2FaultLedTable { atEnvMonv2 6 }	Table detailing any LED fault indications on the device, indexed by: <ul style="list-style-type: none"> ■ atEnvMonv2FaultLedStackMemberId
atEnvMonv2FaultLedEntry { atEnvMonv2FaultLedTable 1 }	Information pertaining to a given fault LED.
atEnvMonv2FaultLedStackMemberId { atEnvMonv2FaultLedEntry 1 }	Index of the stack member hosting this fault LED.
atEnvMonv2FaultLed1Flash { atEnvMonv2FaultLedEntry 2 }	Indicates whether a fault LED is currently showing a system failure by flashing once. Values can be: <ul style="list-style-type: none"> ■ heatsinkFanFailure (1) - indicates that one or more heatsink fans have failed, or are operating below the recommended speed ■ noFault (2)
atEnvMonv2FaultLed2Flashes { atEnvMonv2FaultLedEntry 3 }	Indicates whether a fault LED is currently showing a system failure by flashing twice. Values can be: <ul style="list-style-type: none"> ■ chassisFanFailure (1) - indicates that one or both of the chassis fans are not installed, or the fans are operating below the recommended speed ■ noFault (2)
atEnvMonv2FaultLed3Flashes { atEnvMonv2FaultLedEntry 4 }	Indicates whether a fault LED is currently showing a system failure by flashing three times. Values can be: <ul style="list-style-type: none"> ■ sensorFailure (1) - indicates that the ability to monitor temperature or fans has failed ■ noFault (2)
atEnvMonv2FaultLed4Flashes { atEnvMonv2FaultLedEntry 5 }	Indicates whether a fault LED is currently showing a system failure by flashing four times. Values can be: <ul style="list-style-type: none"> ■ xemInitialisationFailure (1) - indicates that a XEM failed to initialise or is incompatible ■ noFault (2)
atEnvMonv2FaultLed5Flashes { atEnvMonv2FaultLedEntry 6 }	Indicates whether a fault LED is currently showing a system failure by flashing five times. This flashing sequence is not currently in use. Value is: <ul style="list-style-type: none"> ■ noFault (2)
atEnvMonv2FaultLed6Flashes { atEnvMonv2FaultLedEntry 7 }	Indicates whether a fault LED is currently showing a system failure by flashing six times. Values can be: <ul style="list-style-type: none"> ■ temperatureFailure (1) - indicates that the device's temperature has exceeded the recommended threshold ■ noFault (2)

AT-VCSTACK-MIB

AT-VCSTACK-MIB defines objects for managing virtual chassis stacking (Table 79-10). Objects in this group have the object identifier vcstack ({ sysinfo 13 }).

Figure 79-2 on page 79.20 shows the tree structure of the AT-VCSTACK objects.

Figure 79-2: The AT-VCSTACK MIB sub-tree

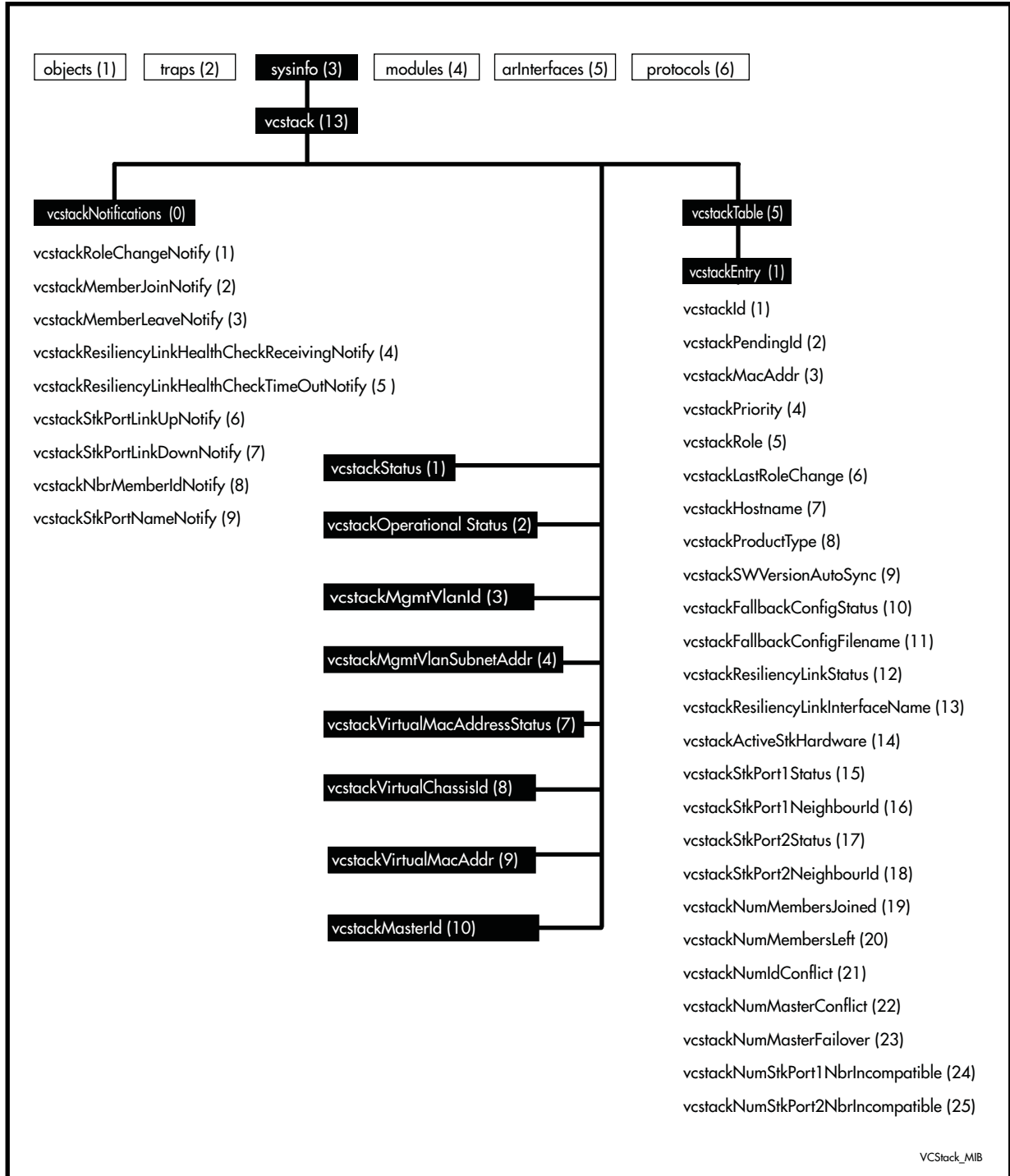

Table 79-10: Objects defined in AT-VCSTACK-MIB

Object	Object Identifier	Description
vcstack	{ sysinfo (13) }	Overall stack status.
vcstackNotifications	{ vcstack 0 }	List of traps (notifications) generated for the stack:
vcstackRoleChangeNotify	{ vcstackNotifications 1 }	The stack status can take one of the following states: <ul style="list-style-type: none"> ■ normalOperation (1) ■ operatingInFailoverState (2) ■ standaloneUnit (3) ■ ringTopologyBroken (4)
vcstackMemberJoinNotify	{ vcstackNotifications 2 }	Notification generated when a member joins the stack. Displays the objects: <ul style="list-style-type: none"> ■ vcstackId ■ vcstackNbrMemberId
vcstackMemberLeaveNotify	{ vcstackNotifications 3 }	Notification generated when a member leaves the stack. Displays the objects: <ul style="list-style-type: none"> ■ vcstackId ■ vcstackNbrMemberId
vcstackResiliencyLinkHealthCheckReceivingNotify	{ vcstackNotifications 4 }	Notification generated when the resiliency link is activated. Displays the objects: <ul style="list-style-type: none"> ■ vcstackId ■ vcstackResiliencyLinkInterface Name
vcstackResiliencyLinkHealthCheckTimeOutNotify	{ vcstackNotifications 5 }	Notification generated when the slave's receive timer has timed-out, indicating that the Slave has lost contact with the Master via the resiliency link. Displays the objects: <ul style="list-style-type: none"> ■ vcstackId ■ vcstackResiliencyLinkInterface Name
vcstackStkPortLinkUpNotify	{ vcstackNotifications 6 }	Notification generated when the stack port link is up. Displays the objects: <ul style="list-style-type: none"> ■ vcstackId ■ vcstackStkPortName
vcstackStkPortLinkDownNotify	{ vcstackNotifications 7 }	Notification generated when the stack port link is down. Displays the objects: <ul style="list-style-type: none"> ■ vcstackId ■ vcstackStkPortName
vcstackNbrMemberIdNotify	{ vcstackNotifications 8 }	The stack member id related to this trap
vcstackStkPortNameNotify	{ vcstackNotifications 9 }	The stack port name related to this trap

Table 79-10: Objects defined in AT-VCSTACK-MIB (cont.)

Object	Object Identifier	Description
vcstackOperationalStatus	{ vcstack 2 }	The operational status of the stack can be either: <ul style="list-style-type: none"> ■ enabled (1) ■ disabled (2)
vcstackMgmtVlanId	{ vcstack 3 }	The current stacking management VLAN ID
vcstackMgmtVlanSubnetAddr	{ vcstack 4 }	The current stacking management VLAN subnet address
vcstackTable	{ vcstack 5 }	Table of information about stack members, indexed by vcstackId.
vcstackEntry	{ vcstackTable 1 }	Information about a single stack member, indexed by vcstackId.
vcstackId	{ vcstackEntry 1 }	Stack member ID.
vcstackPendingId	{ vcstackEntry 2 }	Pending stack member ID.
vcstackMacAddr	{ vcstackEntry 3 }	Stack member's hardware MAC address.
vcstackPriority	{ vcstackEntry 4 }	Priority for election of the stack master. The lowest number has the highest priority.
vcstackRole	{ vcstackEntry 5 }	Stack member's role in the stack. Can be one of the following: <ul style="list-style-type: none"> ■ leaving (1) ■ discovering (2) ■ synchronizing (3) ■ backupMember (4) ■ pendingMaster (5) ■ disabledMaster (6) ■ fallbackMaster (7) ■ activeMaster (8)
vcstackLastRoleChange	{ vcstackEntry 6 }	Time and date when the stack member last changed its role in the stack.
vcstackHostname	{ vcstackEntry 7 }	Stack member's hostname.
vcstackProductType	{ vcstackEntry 8 }	Stack members product type.
vcstackSWVersionAutoSync	{ vcstackEntry 9 }	Whether or not the stack member's software is automatically upgraded.
vcstackFallbackConfigStatus	{ vcstackEntry 10 }	Status of the fallback configuration file. Can be one of: <ul style="list-style-type: none"> ■ fileExists (1) ■ fileNotFound (2) ■ notConfigured (3)

Table 79-10: Objects defined in AT-VCSTACK-MIB (cont.)

Object	Object Identifier	Description
vcstackFallbackConfigFilename	{ vcstackEntry 11 }	Filename of the fallback configuration file.
vcstackResiliencyLinkStatus	{ vcstackEntry 12 }	Status of the stack members resiliency link. Can be one of: <ul style="list-style-type: none"> ■ configured (1) ■ successful (2) ■ failed (3) ■ notConfigured (4)
vcstackResiliencyLinkInterfaceName	{ vcstackEntry 13 }	Name of the interface the resiliency link is configured on.
vcstackActiveStkHardware	{ vcstackEntry 14 }	Stack ports hardware type. Can be one of: <ul style="list-style-type: none"> ■ value (0) is now obsolete ■ xemStk (1) ■ builtinStackingPorts (2) ■ none (3) is now obsolete ■ stackXG (4)
vcstackStkPort1Status	{ vcstackEntry 15 }	Status of stack-port 1. Can be one of the following: <ul style="list-style-type: none"> ■ down (1) ■ neighbourIncompatible (2) ■ discoveringNeighbour (3) ■ learntNeighbour (4)
vcstackStkPort1NeighbourId	{ vcstackEntry 16 }	ID of the neighbor on stack-port 1. Zero indicates no learned neighbor.
vcstackStkPort2Status	{ vcstackEntry 17 }	Status of stack-port 2. Can be one of: <ul style="list-style-type: none"> ■ down (1) ■ neighbourIncompatible (2) ■ discoveringNeighbour (3) ■ learntNeighbour (4)
vcstackStkPort2NeighbourId	{ vcstackEntry 18 }	ID of the neighbor on stack-port 2. Zero indicates no learned neighbor.
vcstackNumMembersJoined	{ vcstackEntry 19 }	Number of times the stack has acquired a member.
vcstackNumMembersLeft	{ vcstackEntry 20 }	Number of times the stack has lost a member.
vcstackNumIdConflict	{ vcstackEntry 21 }	Number of times that a stack member ID conflict has occurred.
vcstackNumMasterConflict	{ vcstackEntry 22 }	Number of times that a stack master conflict has occurred.
vcstackNumMasterFailover	{ vcstackEntry 23 }	Number of times that the stack master has failed.

Table 79-10: Objects defined in AT-VCSTACK-MIB (cont.)

Object	Object Identifier	Description
vcstackNumStkPort1NbrIncompatible	{ vcstackEntry 24 }	Number of times that the neighbor on stack port 1 was incompatible.
vcstackNumStkPort2NbrIncompatible	{ vcstackEntry 25 }	Number of times that the neighbor on stack port 2 was incompatible.
vcstackVirtualMacAddressStatus	{vcstack 7}	Indicates whether the virtual MAC address is enabled or disabled. Read-only object.
vcstackVirtualChassisId	{vcstack 8}	Displays the current virtual chassis ID. Read-only object.
vcstackVirtualMacAddr	{vcstack 9}	Displays the virtual MAC address used by the stack. Read-only object.
vcstackMasterId	{vcstack 10}	Displays the stack ID of the master unit, or the stack ID of the standalone unit. Read-only object

AT-MIBVERSION-MIB

The AT-MIBVERSION-MIB contains an object to display the last software release that contained changes to the supported AT Enterprise MIB definition files ([Table 79-11](#)). Objects in this group have the object identifier atMibsetVersion ({ sysinfo 15 }).

Table 79-11: Object defined in AT-MIBVERSION-MIB

Object	Object Identifier	Description
atMibsetVersion	{ sysinfo 15 }	This object returns a five digit integer which indicates the last software release that contained changes to the supported AT Enterprise MIB definition files. For example, If the currently loaded software release on the device is 5.3.1-0.3 but the Enterprise MIBs have not changed since 5.3.1-0.1, then the value returned will be 53101.

AT-USER-MIB

The AT-USER-MIB contains objects for displaying information about users currently logged into a device, or configured in the Local User Database of the device (Table 79-12). Objects in this group have the object identifier user ({ sysinfo 20 }).

Table 79-12: Objects defined in AT-USER-MIB

Object	Object Identifier	Description
userInfoTable	{ user 1 }	Table containing information about users. Each entry in the table represents a user currently logged into the device. Indexed by: rscBoardType and rscBoardIndex
userInfoEntry	{ userInfoTable 1 }	Information about a single user logged into the device.
userInfoType	{ userInfoEntry 1 }	The type of connection through which the user logged into the device. Can be: <ul style="list-style-type: none"> ■ console (1) ■ aux (2) ■ telnet (3) ■ script (4) ■ stack (5)
userInfoIndex	{ userInfoEntry 2 }	Index of the line upon which the user logged into the device. Can be a value in range 1 to 16.
userInfoName	{ userInfoEntry 3 }	User name of the user logged into the device.
userInfoPrivilegeLevel	{ userInfoEntry 4 }	The user's privilege level. Can be a value in range 1 to 15.
userInfoIdleTime	{ userInfoEntry 5 }	The amount of time since the user was last active, in the form hh:mm:ss.
userInfoLocation	{ userInfoEntry 6 }	The user location or login method. It can be an IP Address used by the user to telnet into the device, or an asyn port, etc.
userInfoPasswordLifetime	{ userInfoEntry 7 }	The number of days remaining until the user's password expires. Depending on the current user setting it will display one of the following: <ul style="list-style-type: none"> ■ No Expiry - the password will never expire (default setting) ■ x days - where x is the remaining lifetime of the current password (maximum lifetime value is 1000 days) ■ -x days (expired) - indicating that the current password expired x days ago
userInfoPasswordLastChange	{ userInfoEntry 8 }	The number of days since the password was last altered.

Table 79-12: Objects defined in AT-USER-MIB (cont.)

Object	Object Identifier	Description
userConfigTable	{ user 2 }	Table containing user configuration information. Each entry in the table relates to a user configured in the Local User Database of the device. Indexed by userConfigIndex.
userConfigEntry	{ userConfigTable 1 }	Information about a single user configured in the Local User Database of the device.
userConfigIndex	{ userConfigEntry 1 }	Unique number used to identify entries in the userConfigTable.
userConfigName	{ userConfigEntry 2 }	The user's name.
userConfigPrivilegeLevel	{ userConfigEntry 3 }	The privilege level granted to the user. Can be a value in range 1 to 15.
userSecurityPasswordRules	{ user 3 }	Information about user password security rules.
userSecurityPasswordHistory	{ userSecurityPasswordRules 1 }	The number of previous passwords that are retained for comparison when a user password is created. A new password must be unique when compared against the previous history. A value of 0 represents no restriction. The maximum number of retained passwords is 15.
userSecurityPasswordLifetime	{ userSecurityPasswordRules 2 }	The maximum number of days that the password may persist before a change is required. A value of 0 represents no expiry. The maximum value is 1000.
userSecurityPasswordWarning	{ userSecurityPasswordRules 3 }	The number of days before the password expires that a warning message is displayed when the user logs in. A value of 0 indicates no warning. The maximum value is 1000 but must always be less than the password lifetime.
userSecurityPasswordMinLength	{ userSecurityPasswordRules 4 }	The minimum allowable password length.
userSecurityPasswordMinCategory	{ userSecurityPasswordRules 5 }	The minimum number of different categories that the password must satisfy to be considered valid. Categories are split into four groups: <ul style="list-style-type: none"> ■ upper-case letters ■ lower-case letters ■ digits ■ special symbols. ASCII characters not included in the previous three categories.
userSecurityPasswordForced	{ userSecurityPasswordRules 6 }	Whether or not a user with an expired password is forced to change their password at the next login. At login a user with an expired password is prompted to change their password. If the new password meets the current security password rules the user is allowed to login, otherwise they are rejected.
userSecurityPasswordReject	{ userSecurityPasswordRules 7 }	Whether or not a user login attempt with an expired password is rejected. If the user is not rejected then they can login.

AT-RESOURCE-MIB

The AT-RESOURCE-MIB contains objects for displaying system hardware resource and host information (Table 79-13). Objects in this group have the object identifier rsc ({ sysinfo 21 }).

Table 79-13: Objects defined in AT-RESOURCE-MIB

Object	Object Identifier	Description
resource	{ sysinfo 21 }	Contains objects for displaying system hardware resource and host information.
rscBoardTable	{ resource 1 }	Table containing information about boards installed in a device. Indexed by: <ul style="list-style-type: none"> ■ rscStkld ■ rscResourceId
rscBoardEntry	{ rscBoardTable 1 }	Information about a single board installed in the device.
rscStkld	{ rscBoardEntry 1 }	The ID of the stack member. It is a number from 1 to 8, assigned to a stackable unit by the operating system when it is stacked. A default value of 1 is given to a stand alone unit.
rscResourceId	{ rscBoardEntry 2 }	The resource ID number of the board. It is a number assigned to a hardware resource when the operating system detects its existence. Can be a value in range 1 to 4294967294.
rscBoardType	{ rscBoardEntry 3 }	The type of board. Can be one of the following: <ul style="list-style-type: none"> ■ Base ■ Expansion ■ Fan module ■ PSU, etc.
rscBoardName	{ rscBoardEntry 4 }	The name of the board. Can be one of the following: <ul style="list-style-type: none"> ■ SwitchBlade x908 ■ XEM-12S ■ AT-PWR05-AC, etc
rscBoardId	{ rscBoardEntry 5 }	The ID number of the board. Its value is an Allied Telesis assigned number, such as 274 for the XEM-12S, or 255 for the AT-9924Ts.
rscBoardBay	{ rscBoardEntry 6 }	The board installation location. Its value can be Bay1, Bay2, PSU1, etc. For a base board, it has a value of a single character space.
rscBoardRevision	{ rscBoardEntry 7 }	The revision number of the board.
rscBoardSerialNumber	{ rscBoardEntry 8 }	The serial number of the board.
hostInfoTable	{ resource 2 }	Table containing general system information. Indexed by rscStkld.
hostInfoEntry	{ hostInfoTable 1 }	Information about a single system parameter
hostInfoDRAM	{ hostInfoEntry 1 }	The host DRAM information.
hostInfoFlash	{ hostInfoEntry 2 }	The host Flash information.
hostInfoUptime	{ hostInfoEntry 3 }	The host up-time.
hostInfoBootloaderVersion	{ hostInfoEntry 4 }	The host boot loader version.

AT-LICENSE-MIB

The AT-LICENSE-MIB contains objects for managing the AlliedWare Plus™ Operating System software licenses: listing applied software licenses, adding new licenses and deleting existing licenses (Table 79-14). The objects reside in the module license { sysinfo 22 }, organized in the following groups:

- Base Software License Table - a table containing the installed base software licenses on the device
- Installed Software License Table - a list of installed software licenses; used also to remove software license from the device
- Available Software Features Table
- LicenseNew - Objects used to install a new license

Table 79-14: Objects defined in AT-LICENSE-MIB

Object	Object Identifier	Description
license	{ sysinfo 22 }	MIB containing objects for listing applied software licenses, adding new licenses, and deleting existing licenses.
baseLicenseTable	{ license 1 }	Table containing information about base software licenses installed on a device. Indexed by: <ul style="list-style-type: none"> ■ baseLicenseStkld
baseLicenseEntry	{ baseLicenseTable 1 }	Information about a single license installed on the device.
baseLicenseStkld	{ baseLicenseEntry 1 }	The index number of the base license entry.
baseLicenseName	{ baseLicenseEntry 2 }	The name of the base license.
baseLicenseQuantity	{ baseLicenseEntry 3 }	The number of licenses issued for this entry.
baseLicenseType	{ baseLicenseEntry 4 }	The type of base license issued.
baseLicenseIssueDate	{ baseLicenseEntry 5 }	The date of issue of the base license.
baseLicenseExpiryDate	{ baseLicenseEntry 6 }	The expiry date of the base license.
baseLicenseFeatures	{ baseLicenseEntry 7 }	The feature set that this license enables, in the format of an octet string. Each bit in the returned octet string represents a particular feature that can be license-enabled. The bit position within the string maps to the feature entry with the same index, in licenseFeatureTable. A binary '1' indicates that the feature is included in the license; a binary '0' indicates that the feature is not included in the license.
licenseTable	{ license 2 }	Table containing information about software licenses installed on the device. Indexed by: <ul style="list-style-type: none"> ■ licenseIndex ■ licenseStackId
licenseEntry	{ licenseTable 1 }	Information about a single installed software license on the device.
licenseStackId	{ licenseEntry 1 }	The index number of the license entry.
licenseIndex	{ licenseEntry 2 }	The index number of the license entry.
licenseName	{ licenseEntry 3 }	The name of the license.
licenseCustomer	{ licenseEntry 4 }	The name of the customer of the license.
licenseQuantity	{ licenseEntry 5 }	The number of licenses issued for this entry.
licenseType	{ licenseEntry 6 }	The type of license issued.
licenseIssueDate	{ licenseEntry 7 }	The date of issue of the license.
licenseExpiryDate	{ licenseEntry 8 }	The expiry date of the license.

Table 79-14: Objects defined in AT-LICENSE-MIB (cont.)

Object	Object Identifier	Description
licenseFeatures	{ licenseEntry 9 }	The feature set that this license enables, in the format of octet string. Each bit in the returned octet string represents a particular feature that can be license-enabled. The bit position within the string maps to the feature entry with the same index, in licenseFeatureTable. A binary '1' indicates that the feature is included in the license; a binary '0' indicates that the feature is not included in the license.
licenseRowStatus	{ licenseEntry 10 }	The current status of the license. The following values may be returned when reading this object: <ul style="list-style-type: none"> ■ active (1) - the license is currently installed and valid ■ notInService (2) - the license has expired or is invalid The following value may be written to this object: <ul style="list-style-type: none"> ■ destroy (6) - the license will be removed from the device; this may result in some features being disabled. Note that a stacked device that has a license deleted may not be able to rejoin the stack after reboot, unless the license is also deleted on all other devices in the stack.
licenseFeatureTable	{ license 3 }	Table containing all available Software Features. All features must be license-enabled to be utilized on the device.
licenseFeatureEntry	{ licenseFeatureTable 1 }	Information about a single feature that must be licensed-enabled in order to be utilized on the device.
licenseFeatureIndex	{ licenseFeatureEntry 1 }	The index number of the feature which must be license-enabled.
licenseFeatureName	{ licenseFeatureEntry 2 }	The name of the feature under licensing control.
licenseFeatureStkMembers	{ licenseFeatureEntry 3 }	The feature set of license features for all stacking members, in the format of an octet string. Each bit in the string maps to an individual stacking member, e.g. bit one represents stacking member one, bit two represents stacking member two, etc. In the case of a standalone unit, the first bit represents the device. A bit value of '1' indicates that the applicable feature is enabled on the matching device; a bit value of '0' indicates that the feature is disabled.
licenseNew	{ license 4 }	Group of objects available for updates, used when installing a new software license on the device.

Table 79-14: Objects defined in AT-LICENSE-MIB (cont.)

Object	Object Identifier	Description
licenseNewStackId	{ licenseNew 1 }	The ID of the stacking member upon which the new license is to be installed. The valid number range is 1 to 10. For a standalone unit, this should be set to the default value of 1.
licenseNewName	{ licenseNew 2 }	The name of the new license to be installed.
licenseNewKey	{ licenseNew 3 }	The key for the new license to be installed.
licenseNewInstall	{ licenseNew 4 }	Used to install new licenses. Values can be: <ul style="list-style-type: none"> ■ true (1) ■ false (2) <p>To commence installation, a valid license name and key must first have been set via the licenseNewName and licenseNewKey respectively. This object should then be set to the value true (1). If either the license name or key is invalid, the write operation will fail.</p> <p>Once installed, the software modules affected by any newly enabled features will automatically be restarted. In some cases a system reboot will also be necessary.</p> <p>Note that a stacked device that has a new license installed on it may not be able to rejoin the stack after reboot, unless the license is also added to all other devices in the stack.</p> <p>When read, the object will always return the value false (2).</p>

AT-TRIGGER-MIB

AT-TRIGGER-MIB defines objects for managing triggers ([Table 79-15](#)). Objects in this group have the object identifier trigger ({ modules 53 }). All objects in this group have read only access.

Table 79-15: Objects defined in AT-TRIGGER-MIB

Object Identifier	Description
triggerTraps { trigger 0 }	Sub-tree for all trigger traps.
triggerTrap { triggerTraps 1 }	Notification generated when a trigger is activated. It returns the value of triggerLastTriggerActivated.
triggerLastTriggerActivated { trigger 1 }	Trigger number of the most recent trigger activated on the switch.
triggerConfigInfoTable { trigger 9 }	Table of information about each trigger that has been configured, indexed by triggerNumber.
triggerConfigInfoEntry { triggerConfigInfoTable 1 }	Information about the configuration of a single trigger.
triggerNumber { triggerConfigInfoEntry 1 }	ID number of the trigger. Values are in range 1- 250.
triggerName { triggerConfigInfoEntry 2 }	Name and description of the trigger.
triggerTypeDetail { triggerConfigInfoEntry 3 }	Trigger type and its activation conditions.
triggerActiveDaysOrDate { triggerConfigInfoEntry 4 }	The days of a week or the date on which the trigger can be activated.
triggerActivateAfter { triggerConfigInfoEntry 5 }	Time after which the trigger can be activated.
triggerActivateBefore { triggerConfigInfoEntry 6 }	Time before which the trigger can be activated.
triggerActiveStatus { triggerConfigInfoEntry 7 }	Whether or not the trigger can be activated.
triggerTestMode { triggerConfigInfoEntry 8 }	Whether or not the trigger is operating in diagnostic (test) mode.
triggerSnmptrap { triggerConfigInfoEntry 9 }	Whether or a not an SNMP trap will be generated when the trigger is activated.
triggerRepeatTimes { triggerConfigInfoEntry 10 }	Whether the trigger can repeat an unlimited number of times (continuous) or a specified number of times. If the trigger can repeat only a specified number of times, then the number of times the trigger has already been activated is displayed in brackets.
triggerLasttimeModified { triggerConfigInfoEntry 11 }	Date and time that the trigger configuration was last modified.
triggerNumberOfActivation { triggerConfigInfoEntry 12 }	Number of times the trigger has been activated since the last restart of the device.
triggerLasttimeActivation { triggerConfigInfoEntry 13 }	Date and time that the trigger was last activated.
triggerNumberOfScripts { triggerConfigInfoEntry 14 }	Number of scripts that this trigger will execute. Values are in range 0-5.

Table 79-15: Objects defined in AT-TRIGGER-MIB (cont.)

Object Identifier	Description
triggerScript1 { triggerConfigInfoEntry 15 }	Name of the first script that this trigger will execute if the trigger is activated.
triggerScript2 { triggerConfigInfoEntry 16 }	Name of the second script that this trigger will execute if the trigger is activated.
triggerScript3 { triggerConfigInfoEntry 17 }	Name of the third script that this trigger will execute if the trigger is activated.
triggerScript4 { triggerConfigInfoEntry 18 }	Name of the fourth script that this trigger will execute if the trigger is activated.
triggerScript5 { triggerConfigInfoEntry 19 }	Name of the fifth script that this trigger will execute if the trigger is activated.
triggerCounters { trigger 10 }	Collection of counters for trigger activations.
triggerNumOfActivation { triggerCounters 1 }	Number of times a trigger has been activated.
triggerNumOfActivationToday { triggerCounters 2 }	Number of times a trigger has been activated today.
triggerNumOfPeriodicActivationToday { triggerCounters 3 }	Number of times a periodic trigger has been activated today.
triggerNumOfInterfaceActivationToday { triggerCounters 4 }	Number of times an interface trigger has been activated today.
triggerNumOfResourceActivationToday { triggerCounters 5 }	Number of times a CPU or memory trigger has been activated today.
triggerNumOfRebootActivationToday { triggerCounters 6 }	Number of times a reboot trigger has been activated today.
triggerNumOfPingPollActivationToday { triggerCounters 7 }	Number of times a ping-poll trigger has been activated today.
triggerNumOfStackMasterFailActivationToday { triggerCounters 8 }	Number of times a stack master fail trigger has been activated today.
triggerNumOfStackMemberActivationToday { triggerCounters 9 }	Number of times a stack member trigger has been activated today.
triggerNumOfStackXemStkActivationToday { triggerCounters 10 }	Number of times a stack XEM trigger has been activated today.

AT-LOOPPROTECT-MIB

The atLoopProtect-MIB (Figure 79-3, Table 79-16) defines objects for managing Loop Protection objects and triggers. Objects in this group have the object identifier atLoopProtect ({ modules 4 }).

Figure 79-3: The ATLoopProtect MIB Sub-tree

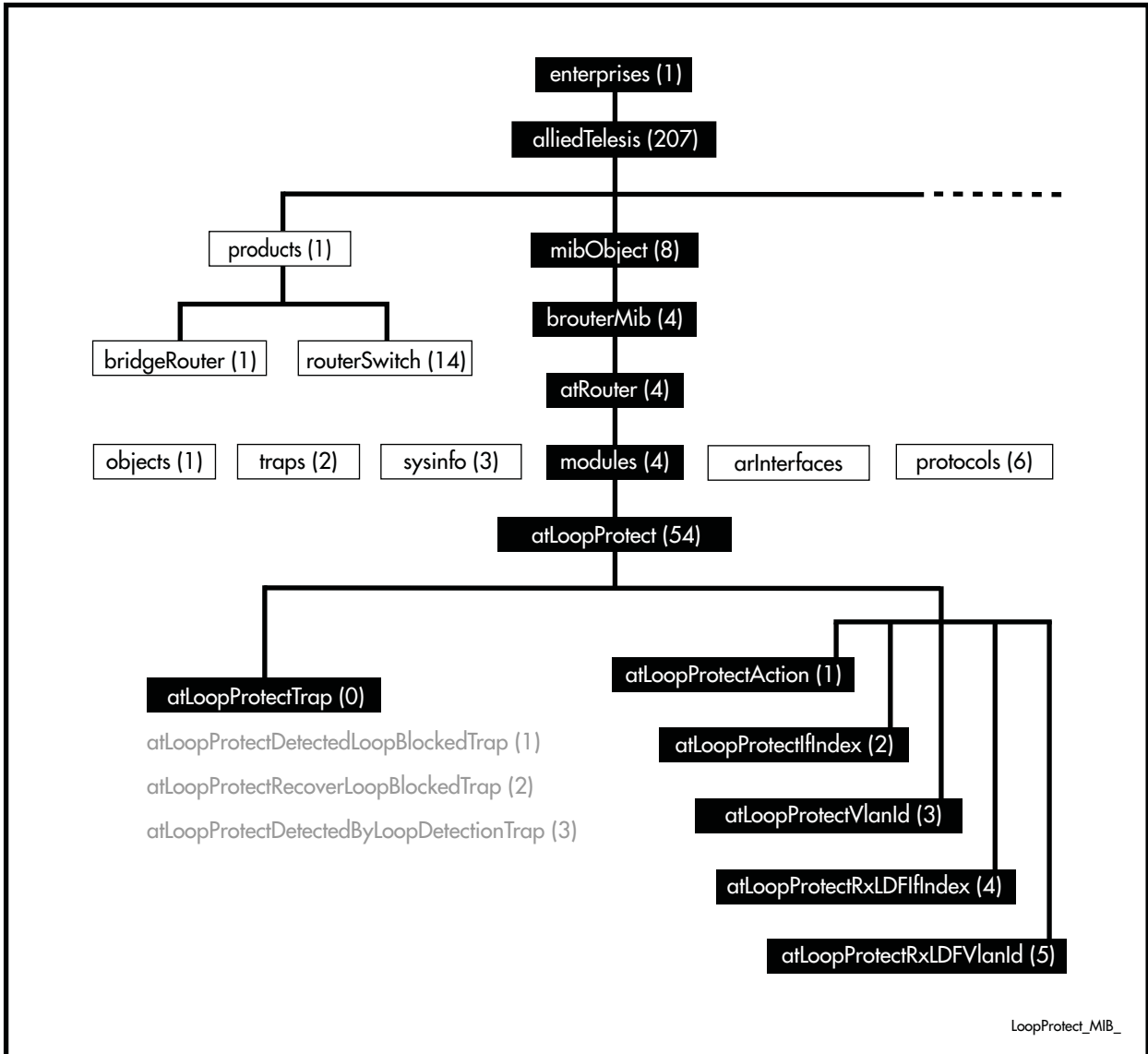

Table 79-16: Objects Defined in the AT-Loop Protect MIB

Object	Object Identifier	Description
{ atLoopProtect }	{ modules 54 }	The root of the Loop Protect object sub tree.
{ atLoopProtectTrap }	{ atLoopProtect0 }	The Loop Protection node state transition trap. List of traps (notifications) generated for Loop Protection.
{ atLoopProtectDetected LoopBlockedTrap }	{ atLoopProtectTrap1 }	Notification generated when the Loop Protection feature blocks an interface with a loop. The following bindings are associated with this trap: <ul style="list-style-type: none"> ■ atLoopProtectIfIndex ■ atLoopProtectVlanId ■ atLoopProtectAction
{ atLoopProtectRecover LoopBlockedTrap }	{ atLoopProtectTrap2 }	Notification generated when the Loop Protection feature restores a blocked interface back to normal operation. The following bindings are associated with this trap: <ul style="list-style-type: none"> ■ atLoopProtectIfIndex ■ atLoopProtectVlanId ■ atLoopProtectAction
{ atLoopProtectDetected ByLoopDetectionTrap }	{ atLoopProtectTrap3 }	Notification generated when the Loop Protection feature detects a loop by Loop Detection method. The following bindings are associated with this trap: <ul style="list-style-type: none"> ■ atLoopProtectIfIndex ■ atLoopProtectVlanId ■ atLoopProtectRxLDFIfIndex ■ atLoopProtectRxLDFVlanId
{ atLoopProtectAction }	{ atLoopProtect1 }	The Action for the Loop Protection feature. The following values are defined: <ul style="list-style-type: none"> ■ atLoopProtectAction-LearnDisable (0) ■ atLoopProtectAction-LearnEnable (1) ■ atLoopProtectAction-PortDisable (2) ■ atLoopProtectAction-PortEnable (3) ■ atLoopProtectAction-LinkDown (4) ■ atLoopProtectAction-LinkUp (5) ■ atLoopProtectAction-VlanDisable (6) ■ atLoopProtectAction-VlanEnable (7)
{ atLoopProtectIfIndex }	{ atLoopProtect2 }	The interface on which the loop was detected.
{ atLoopProtectVlanId }	{ atLoopProtect3 }	The VLAN ID on which the loop was detected.
{ atLoopProtectRxLDFIfIndex }	{ atLoopProtect4 }	The interface on which the loop detection frame was received.
{ atLoopProtectRxLDFVlanId }	{ atLoopProtect5 }	The VLAN ID on which the loop detection frame was received.

AT-SETUP-MIB

AT-SETUP-MIB defines objects for managing software installation and configuration files (Figure 79-4, Table 79-17). Objects in this group have the object identifier setup ({ modules 500 }). The procedure in Table 77-2 on page 77.20 shows how to use these MIB objects to upgrade to a new software version and boot configuration file. For objects used for file copying, see "AT-FILEv2-MIB" on page 79.49.

Figure 79-4: The AT-SETUP-MIB sub-tree

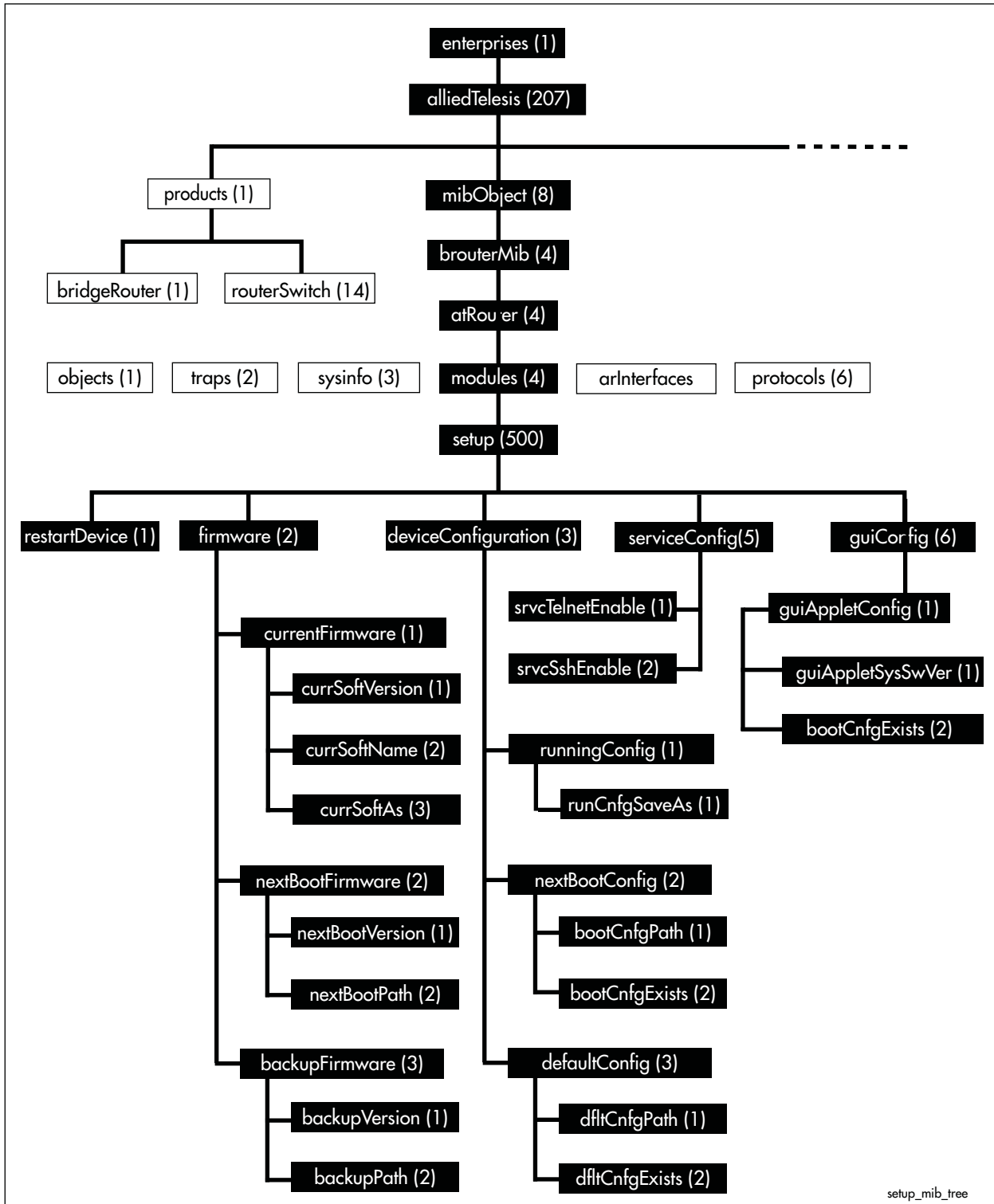

setup_mib_tree

Table 79-17: Objects defined in AT-SETUP-MIB

Object	Object Identifier	Description
restartDevice	{ setup 1 }	Object for restarting the device. When set to '1', the device will restart immediately.
firmware	{ setup 2 }	Objects for managing the software version files that the device will install and run.
currentFirmware	{ firmware 1 }	Information about the current software version installed on the device.
currSoftVersion	{ currentFirmware 1 }	Current Software version.
currSoftName	{ currentFirmware 2 }	Current Software name.
currSoftAs	{ currentFirmware 3 }	The file name to save the currently running software to the root of the flash. Only one save operation can be executed at a time across all SNMP users.
nextBootFirmware	{ firmware 2 }	Information about the software version to be installed on the device when booting.
nextBootVersion	{ nextBootFirmware 1 }	Provides information on the software version (major.minor.interim, for example version 5.3.1) that the device will boot from. A zero will be returned if the version cannot be determined.
nextBootPath	{ nextBootFirmware 2 }	The full path to the release file. In order to set this object, the file must meet the following conditions: <ul style="list-style-type: none"> ■ it must exist ■ it must be located in the root of the flash ■ it must not be the same as the backup release file ■ it must have a .rel suffix ■ it must pass several internal checks to ensure that it is a genuine release file.
backupFirmware	{ firmware 3 }	Information about the backup software version and path.
backupVersion	{ backupFirmware 1 }	Provides information on the backup software version (major.minor.interim, for example version 5.3.1) that the device will boot from. A zero will be returned if the version cannot be determined.
backupPath	{ backupFirmware 2 }	The full path to the backup release file. In order to set this object, the file must meet the following conditions: <ul style="list-style-type: none"> ■ it must exist ■ it must be located in the root of the flash ■ it must not be the same as the configured main release file ■ it must have a .rel suffix ■ it must pass several internal checks to ensure that it is a genuine release file.
deviceConfiguration	{ setup 3 }	Objects for managing device configuration.

Table 79-17: Objects defined in AT-SETUP-MIB (cont.)

Object	Object Identifier	Description
runningConfig	{ deviceConfiguration 1 }	
runCnfgSaveAs	{ runningConfig 1 }	Sets the name of the running config file, to be saved in the root of the flash memory. For example, myconfig.cfg.
nextBootConfig	{ deviceConfiguration 2 }	
bootCnfgPath	{ nextBootConfig 1 }	<p>The full path to the configuration file that will be used the next time the device is rebooted.</p> <p>This object can be set with an empty string in order to clear the current boot configuration; otherwise, the path should be in the form: flash:/myconfig.cfg.</p> <p>In order to set this object, the file must meet the following conditions:</p> <ul style="list-style-type: none"> ■ it must exist ■ it must be located in the root of the flash ■ it must have a .cfg suffix
bootCnfgExists	{ nextBootConfig 2 }	This object will return the value TRUE if the currently defined boot configuration file exists, or FALSE if it does not.
defaultConfig	{ deviceConfiguration 3 }	
dfltCnfgPath	{ defaultConfig 1 }	<p>The full path of the configuration file to use as backup when the device is rebooted.</p> <p>This object is not settable; the default configuration file is always flash:/default.cfg</p>
dfltCnfgExists	{ defaultConfig 2 }	This object will return the value TRUE if the currently defined default configuration file exists, or FALSE if it does not.
serviceConfig	{ setup 5 }	
srvcTelnetEnable	{ serviceConfig 1 }	This object is used to either read or set the state of the telnet server on a device. Telnet can be enabled by setting the value of this object to enable(1) or can be disabled by setting the value disable(2) .
srvcSshEnable	{ serviceConfig 2 }	This object is used to either read or set the state of the SSH server on a device. SSH can be enabled by setting the value of this object to enable(1) or can be disabled by setting the value disable(2) .

Table 79-17: Objects defined in AT-SETUP-MIB (cont.)

Object	Object Identifier	Description
guiConfig	{ setup 6 }	
guiAppletConfig	{ guiConfig 1 }	
guiAppletSysSwVer	{ guiAppletConfig 1 }	<p>This object represents the system software release that the currently selected GUI applet was designed to run on.</p> <p>The system automatically searches for GUI applet files that reside in the root directory of the flash memory, and selects the latest available file that is applicable to the currently running system software. This is the applet that will be uploaded to a user's web browser when they initiate the GUI.</p>
guiAppletSwVer	{ guiAppletConfig 2 }	<p>This object represents the software version of the currently selected GUI applet.</p> <p>The system automatically searches for GUI applet files residing in the root directory of the flash memory, and selects the latest available one that is applicable to the currently running system software. This is the applet that will be uploaded to a user's web browser when they initiate the GUI.</p>

AT-DNS-CLIENT-MIB

AT-DNS-CLIENT-MIB contains definitions of managed objects for the Allied Telesis DNS Client Configuration.

Objects in this group have the object identifier atDns ({ Modules 501 }). [Table 79-18](#) lists the objects supported by the AlliedWare Plus™ Operating System.

Table 79-18: Objects defined in AT-DNS-CLIENT-MIB

Object	Object Identifier	Description
atDnsClient	{ atDns 1 }	MIB File for DNS Client Configuration.
atDNSServerIndexNext	{ atDnsClient 1 }	The next available value for the object 'atDNSServerIndex'. The value is used by a management application to create an entry in the 'atDNSServerTable'.
atDNSServerTable	{ atDnsClient 2 }	Table of information about the Domain Name System (DNS) Server configurations in the system, indexed by 'atDNSServerIndex'.
atDNSServerEntry	{ atDNSServerTable 1 }	Information about a single DNS Server Configuration.
atDNSServerIndex	{ atDNSServerEntry 1 }	The index corresponding to the particular DNS Server Configuration. When creating a new entry in the table, the value of this object must be equal to the value in the 'atDNSServerIndexNext'.
atDNSServerAddrType	{ atDNSServerEntry 2 }	The Internet Address Type of the 'atDNSServerAddr' object. Can be one of the following: <ul style="list-style-type: none"> ■ unknown (0) ■ ipv4 (1) - default value ■ ipv6 (2) - not supported ■ ipv4z (3) - not supported ■ ipv6z (4) - not supported ■ dns (16) - not supported
atDNSServerAddr	{ atDNSServerEntry 3 }	The IP Address of the DNS Server. When a new entry is created, this object is set to the default value of '0.0.0.0' { '00000000'h }. The management application will change this to the desired value using a SET operation.
atDNSServerStatus	{ atDNSServerEntry 4 }	The status of the current entry (row). Can be one of the following: <ul style="list-style-type: none"> ■ active (1) ■ createAndGo (4) ■ destroy (6) <p>To create a new entry the management application must set this object with value 'createAndGo (4)'.</p> <p>To delete an entry, the management application must set this object with value 'destroy (6)'. Once an entry is deleted, all subsequent entries in the table will be renumbered.</p> <p>The default value is 1 (active)</p>

AT-NTP-MIB

This MIB contains objects for managing the Allied Telesis Network Time Protocol (NTP) configuration (Table 79-19). The objects reside in the module atNtp { modules 502 }, organized in the following groups:

- NTP Peer/Server Table - a table containing information on the Network Time Protocol (NTP) peers or server configurations in the system.
- Associations Table - a list of installed software; used also to remove software from the device.
- Status Table - Objects in this group are not supported.

Table 79-19: Objects defined in AT-NTP-MIB

Object	Object Identifier	Description
atNtp	{ modules 502 }	MIB containing objects for configuring NTP.
atNtpPeerIndexNext	{ atNtp 6 }	The next available index number to be used for object 'atNtpPeerIndex'.
atNtpPeerTable	{ atNtp 7 }	Table containing information on the Network Time Protocol (NTP) peers or server configurations in the system. Indexed by: ■ atNtpPeerIndex
atNtpPeerEntry	{ atNtpPeerTable 1 }	Information about a single NTP server or peer configuration.
atNtpPeerIndex	{ atNtpPeerEntry 1 }	The index number corresponding to a particular NTP server or peer configuration in the system. To create a new entry, the value of this object should be the same as that of the value of atNtpPeerIndexNext object, otherwise the entry creation will fail.
atNtpPeerNameAddr	{ atNtpPeerEntry 2 }	The host name, or the IP address of the NTP peer. When a new row (entry) is created, this object is set with a default value of '0.0.0.0', and the management application should change it to a desired value by using a SET operation.
atNtpPeerMode	{ atNtpPeerEntry 3 }	The mode of the peer. Can be one of the following: ■ server (1) ■ peer (2) - default value
atNtpPeerPreference	{ atNtpPeerEntry 4 }	The values in this object specifies whether this peer is the preferred one. Valid values are 0 to 2: ■ 0 - unknown - default value ■ 1 - not preferred ■ 2 - preferred When the value is 'not preferred' (1) NTP chooses the peer with which to synchronize the time on the local system. If the object is set to 'preferred' (2) NTP will choose the corresponding peer to synchronize the time with.

Table 79-19: Objects defined in AT-NTP-MIB (cont.)

Object	Object Identifier	Description
atNtpPeerVersion	{ atNtpPeerEntry 5 }	The NTP version the peer supports. Can be one of the following: <ul style="list-style-type: none"> ■ 0 - unknown - Default value ■ 1 - version 1 ■ 2 - version 2 ■ 3 - version 3 ■ 4 - version 4
atNtpPeerKeyNumber	{ atNtpPeerEntry 6 }	The authentication key number. Default number is 0.
atNtpPeerRow Status	{ atNtpPeerEntry 7 }	The current status of this peer entry. The following values may be returned when reading this object: <ul style="list-style-type: none"> ■ active (1) - this value is returned on reading of this entry. ■ createAndGo (4) - this value is set by the management application when creating a new entry ■ destroy (6) - value set by the management application when deleting the entry. When an entry is deleted, all subsequent entries in the table will be re-indexed.
atNtpAssociationTable	{ atNtp 10 }	Table containing information on the Network Time Protocol (NTP) associations. Indexed by: <ul style="list-style-type: none"> ■ atNtpAssociationIndex
atNtpAssociationEntry	{ atNtpAssociationTable 1 }	Information about a single NTP server or peer configuration.
atNtpAssociationIndex	{ atNtpAssociationEntry 1 }	The index number corresponding to a particular NTP server or peer configuration in the system. To create a new entry, the value of this object should be the same as that of the value of atNtpPeerIndexNext object, otherwise the entry creation will fail.
atNtpAssociationPeerAddr	{ atNtpAssociationEntry 2 }	The host name, or the IP address of the NTP peer. When a new row (entry) is created, this object is set with a default value of '0.0.0.0', and the management application should change it to a desired value by using a SET operation.
atNtpAssociationStatus	{ atNtpAssociationEntry 3 }	The status of this association. Can be one of the following: <ul style="list-style-type: none"> ■ master (syncd) ■ master (unsyncd) ■ selected ■ candidate ■ configured ■ unknown
atNtpAssociationConfigured	{ atNtpAssociationEntry 4 }	The value in this object specifies whether the association is from configuration or not. Value can be: <ul style="list-style-type: none"> ■ configured ■ dynamic
atNtpAssociationRefClkAddr	{ atNtpAssociationEntry 5 }	The IP Address for the reference clock.
atNtpAssociationStratum	{ atNtpAssociationEntry 6 }	The stratum of the peer clock.

Table 79-19: Objects defined in AT-NTP-MIB (cont.)

Object	Object Identifier	Description
atNtpAssociationPoll	{ atNtpAssociationEntry 7 }	The time between NTP requests from the device to the server, in seconds.
atNtpAssociationReach	{ atNtpAssociationEntry 8 }	An integer that indicates the reachability status of the peer.
atNtpAssociationDelay	{ atNtpAssociationEntry 9 }	The round trip delay between the device and the server.
atNtpAssociationOffset	{ atNtpAssociationEntry 10 }	The difference between the device clock and the server clock.
atNtpAssociationDisp	{ atNtpAssociationEntry 11 }	The lowest measure of error associated with peer offset, based on delay, in seconds.
atNtpStatus	{ atNtp 11 }	Group of objects containing system status information. The objects in this group are not supported.
atNtpSysClockSync	{ atNtpStatus 1 }	Not supported.
atNtpSysStratum	{ atNtpStatus 2 }	Not supported.
atNtpSysReference	{ atNtpStatus 3 }	Not supported.
atNtpSysFrequency	{ atNtpStatus 4 }	Not supported.
atNtpSysPrecision	{ atNtpStatus 5 }	Not supported.
atNtpSysRefTime	{ atNtpStatus 6 }	Not supported.
atNtpSysClkOffset	{ atNtpStatus 7 }	Not supported.
atNtpSysRootDelay	{ atNtpStatus 8 }	Not supported.
atNtpSysRootDisp	{ atNtpStatus 9 }	Not supported.

AT-EPSRV2-MIB

The EPSRV2 Group-MIB defines objects for managing Epsrv2 objects and triggers (Figure 79-5, Table 79-20). Objects in this group have the object identifier Epsrv2 (modules 536).

Figure 79-5: The AT-EPSRV2 MIB sub-tree

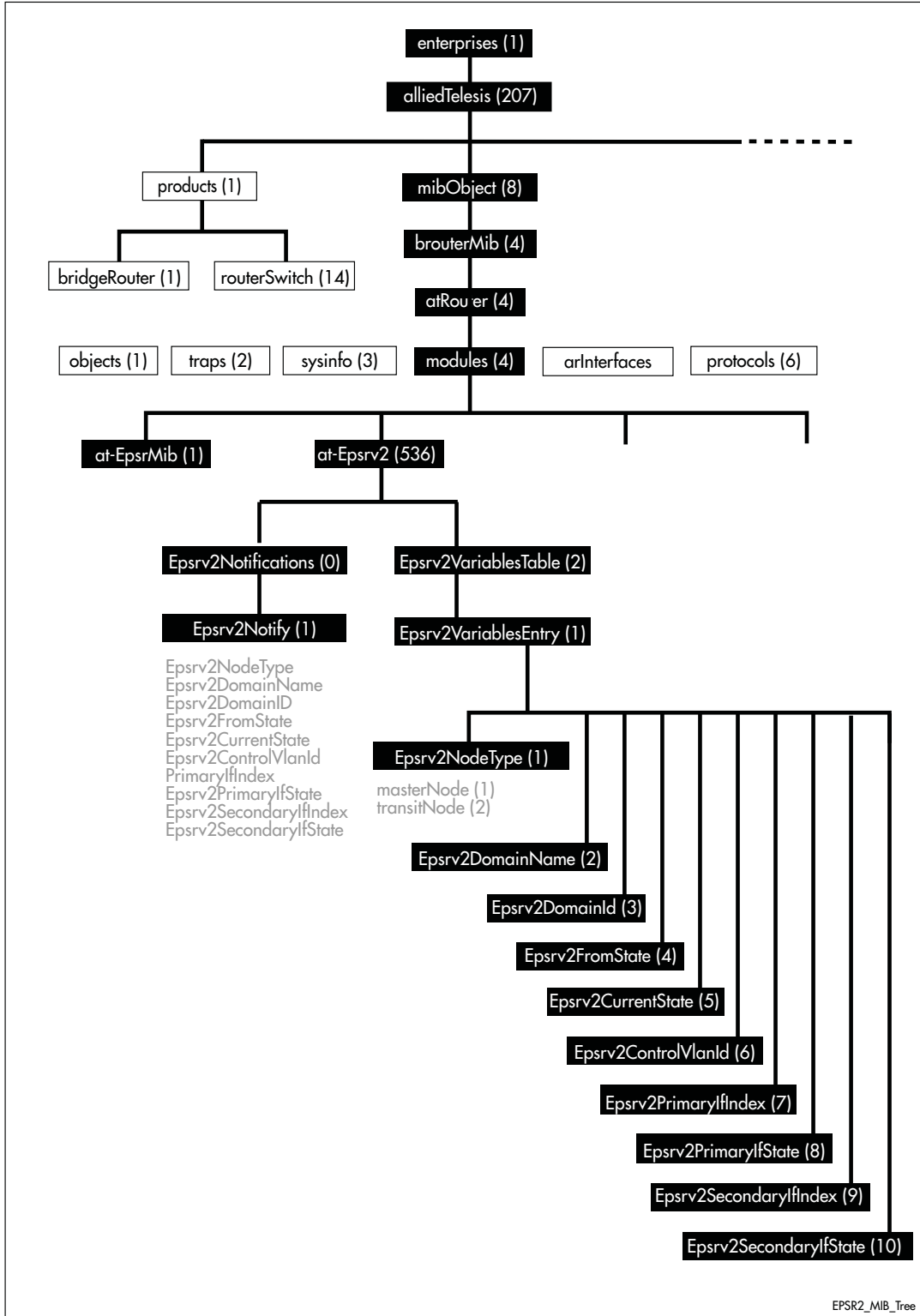

Table 79-20: atEpsrv2Objects Defined in the AT-EPSRV2 MIB

Object	Object Identifier	Description
{ at-Epsrv2 }	{ modules 536 }	The root of the Epsrv2 object sub tree.
{ atEpsrv2Notifications }	{ at-Epsrv2 0 }	
{ atEpsrv2Notify }	{ atEpsrv2Notifications 1 }	EPSR Master/Transit node state transition trap. Note that there is a one to one relationship between nodes and domains.
{ Epsrv2NodeType }	{ atEpsrv2VariablesEntry 1 }	The EPSR node type: either master or transit.
{ atEpsrv2DomainName }	{ atEpsrv2VariablesEntry 2 }	The name of the EPSR domain.
{ atEpsrv2DomainID }	{ atEpsrv2VariablesEntry 3 }	The ID of the EPSR domain.
{ Epsrv2FromState }	{ atEpsrv2VariablesEntry 4 }	The previous state of the EPSR domain
{ Epsrv2Current State }	{ atEpsrv2VariablesEntry 5 }	The current state of the EPSR domain.
{ Epsrv2ControlVlanId }	{ atEpsrv2VariablesEntry 6 }	The VLAN identifier for the control VLAN.
{ Epsrv2PrimaryIflIndex }	{ atEpsrv2VariablesEntry 7 }	The IflIndex of the primary interface.
{ atEpsrv2PrimaryIflState }	{ atEpsrv2VariablesEntry 8 }	The current state of the primary interface.
{ atEpsrv2SecondaryIflIndex }	{ atEpsrv2VariablesEntry 9 }	The IflIndex of the secondary interface.
{ atEpsrv2SecondaryIflState }	{ atEpsrv2VariablesEntry 10 }	The state of the secondary interface.
{ atEpsrv2VariablesTable }	{ at-Epsrv2 2 }	The enterprise Epsrv2VariablesTable.
{ atEpsrv2VariablesEntry }	{ atEpsrv2VariablesTable 1 }	Contains entries within the enterprise atEpsrv2VariablesTable.
{ atEpsrv2NodeType }	{ atEpsrv2VariablesEntry 1 }	The EPSR domain node type: either <ul style="list-style-type: none"> ■ master (1) ■ transit (2)
{ atEpsrv2DomainName }	{ Epsrv2NodeType 2 }	The name of the EPSR domain.
{ atEpsrv2DomainID }	{ Epsrv2NodeType 3 }	The ID of the EPSR domain.
{ atEpsrv2FromState }	{ Epsrv2NodeType 4 }	The previous state of the EPSR domain
{ atEpsrv2Current State }	{ Epsrv2NodeType 5 }	The current state of the EPSR domain.
{ atEpsrv2ControlVlanId }	{ Epsrv2NodeType 6 }	The VLAN identifier for the control VLAN.
{ Epsrv2PrimaryIflIndex }	{ Epsrv2NodeType 7 }	The IflIndex of the primary interface.
{ atEpsrv2PrimaryIflState }	{ Epsrv2NodeType 8 }	The current state of the primary interface.
{ atEpsrv2SecondaryIflIndex }	{ Epsrv2NodeType 9 }	The IflIndex of the secondary interface.
{ atEpsrv2SecondaryIflState }	{ Epsrv2NodeType 10 }	The state of the secondary interface.
TEXTUAL CONVENTIONS		
{ atEpsrv2NodeState }		The trap states that can be advertised for an EPSR domain node. The following states are defined: <ul style="list-style-type: none"> ■ idle (1) ■ complete (2) ■ failed (3) ■ linksUp (4) ■ linksDown (5) ■ preForward (6) ■ unknown (7)
{ atEpsrv2InterfaceState }		The trap states that can be advertised for an EPSR interface. The following states are defined: <ul style="list-style-type: none"> ■ unknown (1) ■ down (2) ■ blocked (3) ■ forward (4)

AT-DHCPSN-MIB

This MIB contains objects for displaying and managing DHCP snooping and ARP security information on the switch. (Table 79-21). The objects reside in the module atDhcpsn { modules 537 }, organized in the following groups:

- The DHCP Snooping Events group (atDhcpsnEvents) contains notifications (traps)
- The DHCP Snooping table (atDhcpsnVariablesTable) contains DHCP snooping information
- The ARP Security table (atArpsecVariablesTable) contains ARP security information

Table 79-21: Objects defined in AT-DHCPSN-MIB

Object	Object Identifier	Description
atDhcpsn	{ modules 537 }	This MIB file contains definitions of managed objects for DHCP Snooping in AlliedWare Plus™.
atDhcpsnEvents	{ atDhcpsn 1 }	DHCP Snooping notifications (traps)
atDhcpsnTrap	{ atDhcpsnEvents 1 }	DHCP Snooping violation notification.
atArpsecTrap	{ atDhcpsnEvents 2 }	DHCP Snooping ARP Security violation notification.
atDhcpsnVariablesTable	{ atDhcpsn 1 }	The DHCP Snooping table. This table contains rows of DHCP Snooping information.
atDhcpsnVariablesEntry	{ atDhcpsnVariablesTable 1 }	A set of parameters that describe the DHCP Snooping features.
atDhcpsnIfIndex	{ atDhcpsnVariablesEntry 1 }	Ifindex of the port that the packet was received on.
atDhcpsnVid	{ atDhcpsnVariablesEntry 2 }	VLAN ID of the port that the packet was received on.
atDhcpsnSmac	{ atDhcpsnVariablesEntry 3 }	Source MAC address of the packet that caused the trap.
atDhcpsnOpcode	{ atDhcpsnVariablesEntry 4 }	Opcode value of the BOOTP packet that caused the trap. Only bootpRequest(1) or bootpReply(2) is valid.
atDhcpsnCiaddr	{ atDhcpsnVariablesEntry 5 }	Ciaddr value of the BOOTP packet that caused the trap.
atDhcpsnYiaddr	{ atDhcpsnVariablesEntry 6 }	Yiaddr value of the BOOTP packet that caused the trap.
atDhcpsnGiaddr	{ atDhcpsnVariablesEntry 7 }	Giaddr value of the BOOTP packet that caused the trap.
atDhcpsnSiaddr	{ atDhcpsnVariablesEntry 8 }	Siaddr value of the BOOTP packet that caused the trap.
atDhcpsnChaddr	{ atDhcpsnVariablesEntry 9 }	Chaddr value of the BOOTP packet that caused the trap.

Table 79-21: Objects defined in AT-DHCPSN-MIB (cont.)

Object	Object Identifier	Description
atDhcpsnVioType	{ atDhcpsnVariablesEntry 10 }	<p>The reason that the trap was generated.</p> <ul style="list-style-type: none"> ■ invalidBootp(1) indicates that the received BOOTP packet was invalid. For example, it is neither BootpRequest nor BootpReply. ■ invalidDhcpAck(2) indicates that the received DHCP ACK was invalid. ■ invalidDhcpRelDec(3) indicates the DHCP Release or Decline was invalid. ■ invalidIp(4) indicates that the received IP packet was invalid. ■ maxBindExceeded(5) indicates that if the entry was added, the maximum bindings configured for the port would be exceeded. ■ opt82InsertErr(6) indicates that the insertion of Option 82 failed. ■ opt82RxInvalid(7) indicates that the received Option 82 information was invalid. ■ opt82RxUntrusted(8) indicates that Option 82 information was received on an untrusted port. ■ opt82TxUntrusted(9) indicates that Option 82 would have been transmitted out an untrusted port. ■ replyRxUntrusted(10) indicates that a BOOTP Reply was received on an untrusted port. ■ srcMacChaddrMismatch(11) indicates that the source MAC address of the packet did not match the BOOTP CHADDR of the packet. ■ staticEntryExisted(12) indicates that the static entry to be added already exists. ■ dbAddErr(13) indicates that adding an entry to the database failed.
atArpsecVariablesTable	{ atDhcpsn 2 }	The ARP Security table. This table contains rows of DHCP Snooping ARP Security information.
atArpsecVariablesEntry	{ atArpsecVariablesTable 1 }	A set of parameters that describe the DHCP Snooping ARP Security features.
atArpsecIfIndex	{ atArpsecVariablesEntry 1 }	Ifindex of the port that the ARP packet was received on.
atArpsecClientIP	{ atArpsecVariablesEntry 2 }	Source IP address of the ARP packet.
atArpsecSrcMac	{ atArpsecVariablesEntry 3 }	Source MAC address of the ARP packet.
atArpsecVid	{ atArpsecVariablesEntry 4 }	VLAN ID of the port that the ARP packet was received on.

Table 79-21: Objects defined in AT-DHCPSN-MIB (cont.)

Object	Object Identifier	Description
atArpsecVioType	{ atArpsecVariablesEntry 5 }	<p>The reason that the trap was generated.</p> <ul style="list-style-type: none"> ■ srcIpNotFound(1) indicates that the Sender IP address of the ARP packet was not found in the DHCP Snooping database. ■ badVLAN(2) indicates that the VLAN of the DHCP Snooping binding entry associated with the Sender IP address of the ARP packet does not match the VLAN that the ARP packet was received on. ■ badPort(3) indicates that the port of the DHCP Snooping binding entry associated with the Sender IP address of the ARP packet does not match the port that the ARP packet was received on. ■ srcIpNotAllocated(4) indicates that the CHADDR of the DHCP Snooping binding entry associated with the Sender IP address of the ARP packet does not match the Source MAC and/or the ARP source MAC of the ARP packet.

AT-FILEv2-MIB

This MIB contains objects for displaying and managing file content of flash, NVS and SD-cards on local and stacked devices, and copying, moving and deleting files from local, stacked and remote sources ([Table 79-22](#)).

The objects reside in the module atFilev2 { modules 600 }, organized in the following groups:

- The Options Table - a collection of codes used to configure file management options
- The File Table - a list of files present on the device and stack-member, specified by the atFilev2Device and atFilev2StackId objects
- The file operation devices - object for various devices supported for file operations
- The SD Card Table - information about the SD Cards configured on the device

Note The file details returned with SNMP have different OID index formats depending on whether or not the device is stacked and if "atFilev2Recursive" is set.



The procedure in "[Copy a File to or from a TFTP Server](#)" on [page 77.19](#) shows how to use these MIB objects to upgrade to a new software version and boot configuration file.

Table 79-22: Objects defined in AT-FILEv2-MIB

Object	Object Identifier	Description
atFilev2	{ modules 600 }	MIB containing objects for listing and managing files
atFilev2TableOptions	{ atFilev2 1 }	Collection of objects available for configuration, to enable various options for file listing
atFilev2Recursive	{ atFilev2TableOptions 1 }	Specifies recursive listing for directories contained in the object atFilev2Table. Valid values are 0 and 1. Set a value of '1' to enable recursive listing of directories in the atFilev2Table listing. The default value is '0'.
atFilev2AllFiles	{ atFilev2TableOptions 2 }	Specifies recursive listing for all files contained in the object atFilev2Table. Valid values are 0 and 1. Set a value of '1' to enable listing of all files (including hidden) in the atFilev2Table listing. The default value is '0'.
atFilev2Device	{ atFilev2TableOptions 3 }	Specifies the type of device where the files to be listed reside. Valid range values are from 1 to 3. Set a value that corresponds with the various devices, as below: <ul style="list-style-type: none"> ■ 1 - Flash - default value ■ 2 - Card ■ 3 - NVS Subsequent SNMP queries to the atFilev2Table will use this as the device to generate a file listing from.
atFilev2StackId	{ atFilev2TableOptions 4 }	An integer to correspond to the stack ID of a stack member. Subsequent SNMP queries to the atFilev2Table will use this as the stack member to generate a file listing from. If running a standalone unit, use the default value of '1'.

Table 79-22: Objects defined in AT-FILEv2-MIB (cont.)

Object (cont.)	Object Identifier	Description
atFilev2Table	{ atFilev2 2 }	The file table, containing a list of files present on the device and stack member specified by the atFilev2Device and atFilev2StackId objects. Indexed by: <ul style="list-style-type: none"> ■ atFilev2FileName
atFilev2Entry	{ atFilev2Table 1 }	An entry in the list of file containing information about a single file.
atFilev2FileName	{ atFilev2Entry 1 }	The name of the file, in the format octet string. Files are sorted in alphabetical order. Directory names end with '/', and have a 'd' present in the atFilev2FileAttrib object. The file name is truncated at 112 characters, due to SNMP OID length limitations. If two files are not uniquely distinguishable within the first 112 characters, the listing will halt after the first file.
atFilev2FileSize	{ atFilev2Entry 2 }	The size of the file in bytes.
atFilev2FileCreationTime	{ atFilev2Entry 3 }	File creation time in the form MMM DD YYYY HH:MM:SS. Example: 'Sep 7 2008 06:07:54'
atFilev2FileAttrib	{ atFilev2Entry 4 }	The standard file accessibility attributes in the form <drwx>, where each letter represents the following: <ul style="list-style-type: none"> ■ d - directory ■ r - readable ■ w - writable ■ x - executable If a file does not have a particular attribute set, the respective position will contain a '-'. For example, <-r-x> indicates a readable and executable file that is not a directory or writable.
atFilev2Operation	{ atFilev2 3 }	Collection of file operation objects available for configuration, to enable copying, moving and deleting files.
atFilev2SourceStackId	{ atFilev2Operation 1 }	Specifies the Stack ID of the source file. Set an integer corresponding to the stack ID of the stack member to use as the source. This value is ignored if the source device is set to TFTP. If running a standalone unit, use the default value of 1.

Table 79-22: Objects defined in AT-FILEv2-MIB (cont.)

Object (cont.)	Object Identifier	Description
atFilev2SourceDevice	{ atFilev2Operation 2 }	<p>Specifies the source device for the file to be copied. Valid values are 0 to 4.</p> <p>Set a value that corresponds with the various devices, as below:</p> <ul style="list-style-type: none"> ■ 0 - Unconfigured (not settable) ■ 1 - Flash - default value ■ 2 - Card ■ 3 - NVS ■ 4 - TFTP <p>For copying, you may use any combination of devices for the source and destination, except for copying from TFTP to TFTP.</p> <p>For moving files you cannot use TFTP as source or destination.</p> <p>For deleting, the source cannot be TFTP.</p> <p>To copy a file from TFTP to flash, use 4 for source and 1 for destination.</p> <p>You must fully configure all required parameters for each device. Only TFTP has an IP address required. Default value is: '1'b.</p>
atFilev2SourceFileName	{ atFilev2Operation 3 }	<p>Specifies the filename of the source file to copy, move or delete.</p> <p>Include any path as required, but the storage type is not necessary.</p> <p>Setting a null string will return an error.</p> <p>For example, to copy the file latest.cfg from the backupconfigs/routers directory on the TFTP server, you would set: backupconfigs/routers/latest.cfg</p>
atFilev2DestinationStackId	{ atFilev2Operation 4 }	<p>Specifies the Stack ID for the destination file.</p> <p>Set an integer corresponding to the stack ID of the stack member to use as the destination. This value is ignored if the destination device is set to TFTP, or if a deletion operation is carried out.</p> <p>If running a standalone unit, use the default value of 1.</p>
atFilev2DestinationDevice	{ atFilev2Operation 5 }	<p>Specifies the destination device for the files to be copied into. Valid values are 0 to 4.</p> <p>Set a value that corresponds with the various devices, as below:</p> <ul style="list-style-type: none"> ■ 0 - Unconfigured (not settable) ■ 1 - Flash - default value ■ 2 - Card ■ 3 - NVS ■ 4 - TFTP <p>For copying, you may use any combination of devices for the source and destination, except for copying from TFTP to TFTP.</p> <p>For moving files you cannot use TFTP as source or destination.</p> <p>For deleting, the source cannot be TFTP.</p> <p>To copy a file from TFTP to flash, use 4 for source and 1 for destination.</p> <p>You must fully configure all required parameters for each device. Only TFTP has an IP address required. Default value is: '1'b.</p>

Table 79-22: Objects defined in AT-FILEv2-MIB (cont.)

Object (cont.)	Object Identifier	Description
atFilev2DestinationFileName	{ atFilev2Operation 6 }	<p>Specifies the destination filename of the file to be copied or moved. Include any path as required, but the storage type is not necessary. For any operation other than a file deletion, setting a null string will return an error. For deletions, any value set to this object is ignored.</p> <p>Note: If the destination is set to flash, card or NVS, any file at the destination that shares the destination filename will be overwritten by a move or copy operation. The destination filename does not need to be the same as the source filename. For example, to copy a release file from the TFTP server to the local flash into the backup release directory, you would set:</p> <pre>backuprelease/latest.rel</pre>

Table 79-22: Objects defined in AT-FILEv2-MIB (cont.)

Object (cont.)	Object Identifier	Description
atFilev2CopyBegin	{ atFilev2Operation 7 }	<p>Represents the status of the copy file operation, in the form of octet string.</p> <p>A read on this object can return several possible values, depending on the current status of the system and the various file operation objects:</p> <ul style="list-style-type: none"> ■ idle - There is no file operation in progress and all required objects have been set correctly. Setting a '1' to this object will begin the file copy. ■ Error codes: [1-7] - A copy operation cannot be started until these errors are resolved. See below for key. ■ [action]ing x [--> y] - A file operation is currently in progress. You cannot start another operation while the object is returning this value. ■ [action] x [--> y] success - The last copy, move or delete operation was successfully completed. ■ [action] x [--> y] failure: [err] - The last copy, move or delete operation failed, with the error message attached. Common failures include lack of space on the destination file system, incorrect source file names or communication errors with remote services. <p>Upon reading a success or failure message, the message will be cleared and the next read will result in either an 'idle' message or an 'Error codes' message if not all required objects have been correctly set. If the read returned 'idle', a new file operation can now be started.</p> <p>Following are possible values returned as Error codes for file copy:</p> <ul style="list-style-type: none"> ■ 1 - atFilev2SourceDevice has not been set ■ 2 - atFilev2SourceFilename has not been set ■ 3 - atFilev2DestinationDevice has not been set ■ 4 - atFilev2DestinationFilename has not been set ■ 5 - atFilev2SourceDevice and atFilev2DestinationDevice are both set to TFTP ■ 6 - the combination of source device, stackID and filename is the same as the destination device, stackID and filename (i.e. it is not valid to copy a file onto itself). ■ 7 - TFTP IP address has not been set and TFTP has been set for one of the devices <p>Provided all above requirements are met, immediately upon executing the SNMP set, the device will indicate that it was a success.</p> <p>The actual file copy itself will be started and continue on the device until it has completed.</p> <p>For large files, operations can take several minutes to complete.</p> <p>Subsequent reads of the object will return one of messages shown in the first table, to allow for tracking of the progress of the copy operation.</p>

Table 79-22: Objects defined in AT-FILEv2-MIB (cont.)

Object (cont.)	Object Identifier	Description
atFilev2MoveBegin	{ atFilev2Operation 8 }	<p>Represents the status of the move file operation, in the form of octet string.</p> <p>A read on this object can return several possible values, depending on the current status of the system and the various file operation objects:</p> <ul style="list-style-type: none"> ■ idle - There is no file operation in progress and all required objects have been set correctly. Setting a '1' to this object will begin the file move. ■ Error codes: [1-6] - A move operation cannot be started until these errors are resolved. See below for key. ■ [action]ing x [--> y] - A file operation is currently in progress. You cannot start another operation while the object is returning this value. ■ [action] x [--> y] success - The last copy, move or delete operation was successfully completed. ■ [action] x [--> y] failure: [err] - The last copy, move or delete operation failed, with the error message attached. Common failures include lack of space on the destination file system, incorrect source file names or communication errors with remote services. <p>Upon reading a success or failure message, the message will be cleared and the next read will result in either an 'idle' message or an 'Error codes' message if not all required objects have been correctly set. If the read returned 'idle', a new file operation can now be started.</p> <p>Following are possible values returned as Error codes for file move:</p> <ul style="list-style-type: none"> ■ 1 - atFilev2SourceDevice has not been set ■ 2 - atFilev2SourceFilename has not been set ■ 3 - atFilev2DestinationDevice has not been set ■ 4 - atFilev2DestinationFilename has not been set ■ 5 - either atFilev2SourceDevice or atFilev2DestinationDevice are set to TFTP ■ 6 - the combination of source device, stackID and filename is the same as the destination device, stackID and filename (i.e. it is not valid to move a file onto itself). <p>Provided all above requirements are met, immediately upon executing the SNMP set, the device will indicate that it was a success.</p> <p>The actual file move itself will be started and continue on the device until it has completed.</p> <p>For large files, operations can take several minutes to complete.</p> <p>Subsequent reads of the object will return one of messages shown in the first table, to allow for tracking of the progress of the move operation.</p>

Table 79-22: Objects defined in AT-FILEv2-MIB (cont.)

Object (cont.)	Object Identifier	Description
atFilev2DeleteBegin	{ atFilev2Operation 9 }	<p>Represents the status of the delete file operation, in the form of octet string.</p> <p>A read on this object can return several possible values, depending on the current status of the system and the various file operation objects:</p> <ul style="list-style-type: none"> ■ idle - There is no file operation in progress and all required objects have been set correctly. Setting a '1' to this object will begin the file deletion. ■ Error codes: [1-3] - A delete operation cannot be started until these errors are resolved. See below for key. ■ [action]ing x [--> y] - A file operation is currently in progress. You cannot start another operation while the object is returning this value. ■ [action] x [--> y] success - The last copy, move or delete operation was successfully completed. ■ [action] x [--> y] failure: [err] - The last copy, move or delete operation failed, with the error message attached. Common failures include lack of space on the destination file system, incorrect source file names or communication errors with remote services. <p>Upon reading a success or failure message, the message will be cleared and the next read will result in either an 'idle' message or an 'Error codes' message if not all required objects have been correctly set. If the read returned 'idle', a new file operation can be started.</p> <p>File deletion operations ignore the values set in the atFilev2DestinationStackID, atFilev2DestinationDevice and atFilev2DestinationFilename objects.</p> <p>The file deletion operation is equivalent to the CLI 'delete force [file]' command, so it is possible to delete any normally-protected system files, such as the currently configured boot release.</p> <p>Following are possible values returned as Error codes for file move:</p> <ul style="list-style-type: none"> ■ 1 - atFilev2SourceDevice has not been set ■ 2 - atFilev2SourceFilename has not been set ■ 3 - atFilev2SourceDevice has not been set to TFTP <p>Provided all above requirements are met, immediately upon executing the SNMP set, the device will indicate that it was a success.</p> <p>The actual file move itself will be started and continue on the device until it has completed.</p> <p>For large files, operations can take several minutes to complete.</p> <p>Subsequent reads of the object will return one of messages shown in the first table, to allow for tracking of the progress of the move operation.</p>
atFilev2Flash_1	{ atFilev2Operation 10 }	Represents the Flash operation device object
atFilev2Card_2	{ atFilev2Operation 11 }	Represents the Card operation device object
atFilev2Nvs_3	{ atFilev2Operation 12 }	Represents the NVS operation device object

Table 79-22: Objects defined in AT-FILEv2-MIB (cont.)

Object (cont.)	Object Identifier	Description
atFilev2Tftp_4	{ atFilev2Operation 13 }	Represents the TFTP operation device object
atFilev2TftpIPAddr	{ atFilev2Tftp_4 1 }	The IP address of the TFTP server that is to be used for the file copy process. This IP Address needs to be reachable from the device, or the file copy will fail.
atFilev2SDcardTable	{ atFilev2 4 }	The SD Card table, containing information related to SD Cards. Indexed by: <ul style="list-style-type: none"> ■ atFilev2SDcardStackMemberId
atFilev2SDcardEntry	{ atFilev2SDcardTable 1 }	Data pertaining to an SD Card instance.
atFilev2SDcardStackMemberId	{ atFilev2SDcardEntry 1 }	The index of the stack member hosting this SD Card.
atFilev2SDcardPresence	{ atFilev2SDcardEntry 2 }	This object indicates whether or not an SD Card is inserted into a slot. Possible values are: <ul style="list-style-type: none"> ■ notPresent (1) ■ present (2)

AT-LOG-MIB

The AT Log MIB contains objects for listing log entries from the buffered and permanent logs (Table 79-23). The objects reside in the module log { modules 601 }, organized in the following groups:

- Log Table - objects containing the information from log messages issued by the system, ordered from oldest to newest entry
- Log Options - contains objects used to set up the log options configuration

Table 79-23: Objects defined in AT-LOG-MIB

Object	Object Identifier	Description
log	{ modules 601 }	MIB containing objects for listing log entries from the buffered and permanent logs.
logTable	{ log 1 }	A list of log entries from the source specified in the 'logSource' object. The list is ordered from oldest entry to newest entry. Indexed by: ■ logIndex
logEntry	{ logTable 1 }	Information about a single log entry, from the source specified in the 'logSource' object.
logIndex	{ logEntry 1 }	An index integer. This index is not directly tied to any specific log entry. Over time, the log will grow larger and eventually older entries will be removed from the log.
logDate	{ logEntry 2 }	The date of the log entry. Data resides in the format octet string, in the form YYYY MMM DD, e.g. 2008 Oct 9.
logTime	{ logEntry 3 }	The time of the log entry. Data resides in the format octet string, in the form HH:MM:SS, e.g. 07:15:04.
logFacility	{ logEntry 4 }	The syslog facility that generated the log entry, in the format octet string. See the reference manual for more information.
logSeverity	{ logEntry 5 }	The severity level of the log entry, in the format octet string. Severities are given below: <ul style="list-style-type: none"> ■ emerg Emergency, system is unusable ■ alert Action must be taken immediately ■ crit Critical conditions ■ errr Error conditions ■ warning Warning conditions ■ notice Normal, but significant, conditions ■ info Informational messages ■ debug Debug-level messages
logProgram	{ logEntry 6 }	The program that generated the log entry, in the format octet string. See the reference manual for more information.
logMessage	{ logEntry 7 }	The message of the log entry, in the format octet string.
logOptions	{ log 2 }	Contains objects used to set up the required log options configuration.

Table 79-23: Objects defined in AT-LOG-MIB (cont.)

Object	Object Identifier	Description
logSource	{ logOptions 1 }	<p>An integer indicating the source from which the log entries are retrieved. The valid values are:</p> <ul style="list-style-type: none"> ■ 1 - Buffered log (default) ■ 2 - Permanent log. <p>This information is used when retrieving the logTable objects, and also specifies the log to be cleared when the 'clearLog' object is set.</p>
logAll	{ logOptions 2 }	<p>An integer indicating whether to display all log entries in the logTable objects, or not. The valid values are:</p> <ul style="list-style-type: none"> ■ 0 - to display only the most recent log messages. This is the default ■ 1 - to show all available log entries. <p>Note: Choosing to display all log entries may result in delays of several seconds when accessing the logTable objects.</p>
clearLog	{ logOptions 3 }	<p>An integer indicating whether to clear the log that is specified by the 'logSource' object. Valid values are:</p> <ul style="list-style-type: none"> ■ 0 - do not clear log ■ 1 - clear log

AT-IP-MIB

This MIB contains objects for Allied Telesis specific IP address management (Table 79-24). The objects reside in the module atIpMib { modules 602 }.

Table 79-24: Objects defined in AT-IP-MIB

Object	Object Identifier	Description
atIpMib	{ modules 602 }	MIB containing objects for IP addressing management.
AtIpAddressAssignmentType	Textual Convention	Object containing conditional coded values for the IP address assignment type being applied to the interface, referred to by objects in this MIB. The possible values and explanation are: <ul style="list-style-type: none"> ■ notSet (0) - indicates that the IP address assignment type has not yet been configured. This value can only ever be read. ■ primary (1) - indicates that the address is a primary IP address; only one primary address is allowed per interface. ■ secondary (2) - indicates that the address is a secondary IP address; any number of secondary IP addresses may be applied
AtIpAddressTable	{ atIpMib 1 }	A table containing mappings between primary or secondary IP addresses, and the interfaces they are assigned to. Indexed by: <ul style="list-style-type: none"> ■ atIpAddressAddrType ■ atIpAddressAddr
AtIpAddressEntry	{ AtIpAddressTable 1 }	Information about the address mapping for a particular interface.
atIpAddressAddrType	{ AtIpAddressEntry 1 }	An indication of the IP version of 'atIpAddressAddr'
atIpAddressAddr	{ AtIpAddressEntry 2 }	The IP address to which this entry's addressing information pertains. The address type of this object is specified in object 'atIpAddressAddrType'.
atIpAddressPrefixLen	{ AtIpAddressEntry 3 }	An integer, specifying the prefix length of the IP address represented by this entry.
atIpAddressLabel	{ AtIpAddressEntry 4 }	The name assigned to the IP address represented by this entry.
atIpAddressIfIndex	{ AtIpAddressEntry 5 }	The index value that uniquely identifies the interface to which this entry is applicable. The interface identified by a particular value of this index corresponds to the interface identified by the same value of the IF-MIB's ifIndex.
atIpAddressAssignmentType	{ AtIpAddressEntry 6 }	The IP address assignment type for this entry (primary or secondary), as described in the Textual Convention 'AtIpAddressAssignmentType'.

Table 79-24: Objects defined in AT-IP-MIB (cont.)

Object	Object Identifier	Description
atIpAddressRowStatus	{ AtIpAddressEntry 7 }	<p>The current status of the IP address entry. The following values may be returned when reading this object:</p> <ul style="list-style-type: none"> ■ active (1) The IP address is currently mapped to an interface and is valid. ■ notReady (3) The IP address is currently partially configured and is not mapped to an interface. <p>The following values may be written to this object:</p> <ul style="list-style-type: none"> ■ active (1) An attempt will be made to map the IP address to the configured interface. ■ createAndWait (5) An attempt will be made to create a new IP address entry. ■ destroy (6) The IP address setting will be removed from the device. <p>An entry cannot be made active until its atIpAddressPrefixLen, atIpAddressIfIndex and atIpAddressAssignmentType objects have been set to valid values.</p>

Public MIBs

The following table lists the public MIBs supported by the AlliedWare Plus™ Operating System. In general, all objects are supported except where the relevant protocol or feature is either not supported or not applicable to the device. Any variations from the standard are listed.

Table 79-25: Public MIBs Supported by AlliedWare Plus™

MIB Name	Reference / Implementation
IANAifType-MIB	www.iana.org/assignments/ianaiftype-mib , IANAifType textual convention.
RFC1155-SMI	RFC 1155, <i>Structure and Identification of Management Information for TCP/IP-based Internets</i> .
-	RFC 1212, <i>Concise MIB Definitions</i> .
RFC1213-MIB	<p>RFC 1213, <i>Management Information Base for Network Management of TCP/IP-based internets: MIB-II</i>.</p> <p>The following objects are not supported:</p> <ul style="list-style-type: none"> ■ ipInReceives ■ ipInHdrErrors ■ ipInAddrErrors ■ ipForwDatagrams ■ ipInUnknownProtos ■ ipInDiscards ■ ipInDelivers ■ ipOutRequests ■ ipOutDiscards ■ ipOutNoRoutes ■ ipReasmTimeout ■ ipReasmReqds ■ ipReasmOKs ■ ipReasmFails ■ ipFragOKs ■ ipFragFails ■ ipFragCreates ■ ipAdEntReasmMaxSize ■ ipNetToMediaTable ■ ipRoutingDiscards ■ all objects in the egp group (EGP is not supported)
	RFC 1215, <i>A Convention for Defining Traps for use with the SNMP</i> .
	RFC 1239, <i>Reassignment of Experimental MIBs to Standard MIBs</i> .

Table 79-25: Public MIBs Supported by AlliedWare Plus™ (cont.)

MIB Name	Reference / Implementation
IP-MIB	<p>RFC 2011, <i>SNMPv2 Management Information Base for the Internet Protocol using SMIv2</i>.</p> <p>The following objects are not supported:</p> <ul style="list-style-type: none"> ■ ipInReceives ■ ipInHdrErrors ■ ipInAddrErrors ■ ipForwDatagrams ■ ipInUnknownProtos ■ ipInDiscards ■ ipInDelivers ■ ipOutRequests ■ ipOutDiscards ■ ipOutNoRoutes ■ ipReasmTimeout ■ ipReasmReqds ■ ipReasmOKs ■ ipReasmFails ■ ipFragOKs ■ ipFragFails ■ ipFragCreates ■ ipAdEntReasmMaxSize ■ ipNetToMediaTable ■ ipRoutingDiscards ■ ipAddressTable (use atIpAddressTable in AT-IP-MIB instead)
TCP-MIB	RFC 2012, <i>SNMPv2 Management Information Base for the Transmission Control Protocol using SMIv2</i> .
UDP-MIB	RFC 2013, <i>SNMPv2 Management Information Base for the User Datagram Protocol using SMIv2</i> .
IP-FORWARD-MIB	<p>RFC 2096, <i>IP Forwarding Table MIB</i>.</p> <p>The following objects are obsolete:</p> <ul style="list-style-type: none"> ■ ipForwardNumber ■ ipForwardTable ■ ipForwardMultiPathGroup ■ ipForwardOldCompliance ■
-	RFC 2257, <i>Agent Extensibility (AgentX) Protocol Version 1</i> .
SNMP-MPD-MIB	RFC 2572, <i>Message Processing and Dispatching for the Simple Network Management Protocol (SNMP)</i> .
SNMP-COMMUNITY-MIB	RFC 2576, <i>Coexistence between Version 1, Version 2, and Version 3 of the Internet-standard Network Management Framework</i> .
SNMPv2-SMI	RFC 2578, <i>Structure of Management Information Version 2 (SMIv2)</i> .
SNMPv2-TC	RFC 2579, <i>Textual Conventions for SMIv2</i> .
SNMPv2-CONF	RFC 2580, <i>Conformance Statements for SMIv2</i> .

Table 79-25: Public MIBs Supported by AlliedWare Plus™ (cont.)

MIB Name	Reference / Implementation
P-BRIDGE-MIB	<p>RFC 2674, <i>Definitions of Managed Objects for Bridges with Traffic Classes, Multicast Filtering and Virtual LAN Extensions</i>.</p> <p>The following objects are not supported:</p> <ul style="list-style-type: none"> ■ dot1dTpPortOverflowTable ■ dot1dTrafficClassesEnabled ■ dot1dGmrpStatus ■ dot1dPortCapabilitiesTable ■ dot1dUserPriority ■ dot1dTrafficClassPriority ■ dot1dPortOutboundAccessPriorityTable ■ all objects in the dot1dGarp group ■ all objects in the dot1dGmrp group <p>The following read-write objects are implemented as read-only:</p> <ul style="list-style-type: none"> ■ dot1dPortDefaultUserPriority ■ dot1dPortNumTrafficClasses ■ dot1dTrafficClass
Q-BRIDGE-MIB	<p>RFC 2674, <i>Definitions of Managed Objects for Bridges with Traffic Classes, Multicast Filtering and Virtual LAN Extensions</i>.</p> <p>The following objects are not supported:</p> <ul style="list-style-type: none"> ■ dot1qGvrpStatus ■ dot1qFdbld ■ dot1qTpFdbAddress ■ dot1qTpGroupTable ■ dot1qForwardAllTable ■ dot1qForwardUnregisteredTable ■ all objects in the dot1qStatic group ■ dot1qVlanTimeMark ■ dot1qVlanIndex ■ dot1qVlanCurrentEgressPorts ■ dot1qVlanCurrentUntaggedPorts ■ dot1qVlanForbiddenEgressPorts ■ dot1qPortGvrpStatus ■ dot1qPortGvrpFailedRegistrations ■ dot1qPortGvrpLastPduOrigin ■ dot1qPortRestrictedVlanRegistration ■ dot1qPortVlanStatisticsTable ■ dot1qPortVlanHCStatisticsTable ■ dot1qLearningConstraintsTable <p>The following read-write objects are implemented as read-only:</p> <ul style="list-style-type: none"> ■ dot1qPvid ■ dot1qPortAcceptableFrameTypes
VRRP-MIB	<p>RFC 2787, <i>Definitions of Managed Objects for the Virtual Router Redundancy Protocol</i>.</p> <p>All objects with read-write and read-create access are implemented as read-only.</p>

Table 79-25: Public MIBs Supported by AlliedWare Plus™ (cont.)

MIB Name	Reference / Implementation
HOST-RESOURCES-MIB	RFC 2790, <i>Host Resources MIB</i> . The following objects are not supported: <ul style="list-style-type: none"> ■ hrStorageAllocationFailures ■ All objects in hrDevice ■ All objects in hrSWRun ■ All objects in hrSWRunPerf ■ All objects in hrSWInstalled ■ All objects in hrMIBAdminInfo
SNMPv2-PDU	RFC 3416, <i>Version 2 of the Protocol Operations for the Simple Network Management Protocol (SNMP)</i> .
SNMPv2-TM	RFC 3417, <i>Transport Mappings for the Simple Network Management Protocol (SNMP)</i> .
SNMPv2-MIB	RFC 3418, <i>Management Information Base (MIB) for the Simple Network Management Protocol (SNMP)</i> .
EtherLike-MIB	RFC 3635, <i>Definitions of Managed Objects for the Ethernet-like Interface Types</i> . The following objects are deprecated: <ul style="list-style-type: none"> ■ dot3StatsEtherChipSet ■ all objects in the dot3Tests group ■ all objects in the dot3Errors group The following read-write object is implemented as read-only: <ul style="list-style-type: none"> ■ dot3PauseAdminMode
MAU-MIB	RFC 3636, <i>Definitions of Managed Objects for IEEE 802.3 Medium Attachment Units (MAUs)</i> . The following objects are not supported: <ul style="list-style-type: none"> ■ all objects in the dot3RpMauBasicGroup group ■ ifMauTypeListBits ■ ifMauHCFalseCarriers ■ all object identifiers in the dot3MauType group ■ ifMauAutoNegCapabilityBits ■ ifMauAutoNegCapAdver tisedBits ■ ifMauAutoNegCapReceivedBits ■ ifMauAutoNegRemoteFaultAdver tised ■ ifMauAutoNegRemoteFaultReceived ■ all objects in the mauMod group The following objects are deprecated: <ul style="list-style-type: none"> ■ ifMauTypeList ■ all objects in the dot3BroadMauBasicGroup group ■ ifMauAutoNegCapability ■ ifMauAutoNegCapAdver tised ■ ifMauAutoNegCapReceived The following read-write object is implemented as read-only: <ul style="list-style-type: none"> ■ ifMauStatus
INET-ADDRESS-MIB	RFC 4001, <i>Textual Conventions for Internet Network Addresses</i> .
BRIDGE-MIB	RFC 4188, <i>Definitions of Managed Objects for Bridges</i> . The following objects are not supported: <ul style="list-style-type: none"> ■ dot1dStaticTable ■ dot1dBaseDelayExceededDiscards ■ dot1dBasePortMtuExceededDiscards

Table 79-25: Public MIBs Supported by AlliedWare Plus™ (cont.)

MIB Name	Reference / Implementation
RSTP-MIB	<p>RFC 4318, <i>Definitions of Managed Objects for Bridges with Rapid Spanning Tree Protocol</i>.</p> <p>The following object is deprecated:</p> <ul style="list-style-type: none"> ■ dot1dStpPathCostDefault
DISMAN-PING-MIB	<p>RFC 4560, <i>Definitions of Managed Objects for Remote Ping, Traceroute, and Lookup Operations</i>.</p> <p>The following (IldpLocManAddrTable and IldpConfigManAddrTable) read-write object is implemented as read-only:</p> <ul style="list-style-type: none"> ■ pingMaxConcurrentRequests <p>You can specify multiple ping operations, but the device only performs one ping at a time (pingMaxConcurrentRequests).</p> <p>The device uses ICMP echo for ping operations (pingImplementationTypeDomains).</p>
LLDP-MIB	<p><i>IEEE Standard 802.1AB-2005, Section 12, LLDP MIB Definitions</i>.</p> <p>The following local management address table supports only a single management address per port:</p> <ul style="list-style-type: none"> ■ IldpConfigManAddrTable
LLDP-EXT-DOT1-MIB	<p><i>IEEE Standard 802.1AB-2005, Annex F, IEEE 802.1 Organizationally Specific TLVs, Section F.7.1, IEEE 802.1LLDP extension MIB module</i>.</p> <p>In each of the following tables, if one entry is set, all other entries in the table are set to the same value.</p> <ul style="list-style-type: none"> ■ IldpXdot1ConfigVlanNameTxEnable ■ IldpXdot1ConfigProtoVlanTxEnable ■ IldpXdot1ConfigProtocolTxEnable
LLDP-EXT-DOT3-MIB	<p><i>IEEE Standard 802.1AB-2005, Annex G, IEEE 802.3 Organizationally Specific TLVs, Section G.7.1, IEEE 802.3 LLDP extension MIB module</i></p>
LLDP-EXT-MED-MIB	<p><i>ANSI/TIA-1057- 2006, Section 13.3, LLDP-MED MIB Definition</i></p>

Private MIBs

In general, all objects are supported except where the relevant protocol or feature is either not supported or not applicable to the device. The following table lists the private MIBs supported by the AlliedWare Plus™ Operating System. Any variations from the standard are listed.

MIB Name	Reference / Implementation
sFlow-MIB	All MIB objects are fully supported For more information, see www.sflow.org/SFLOW-MIB5.txt

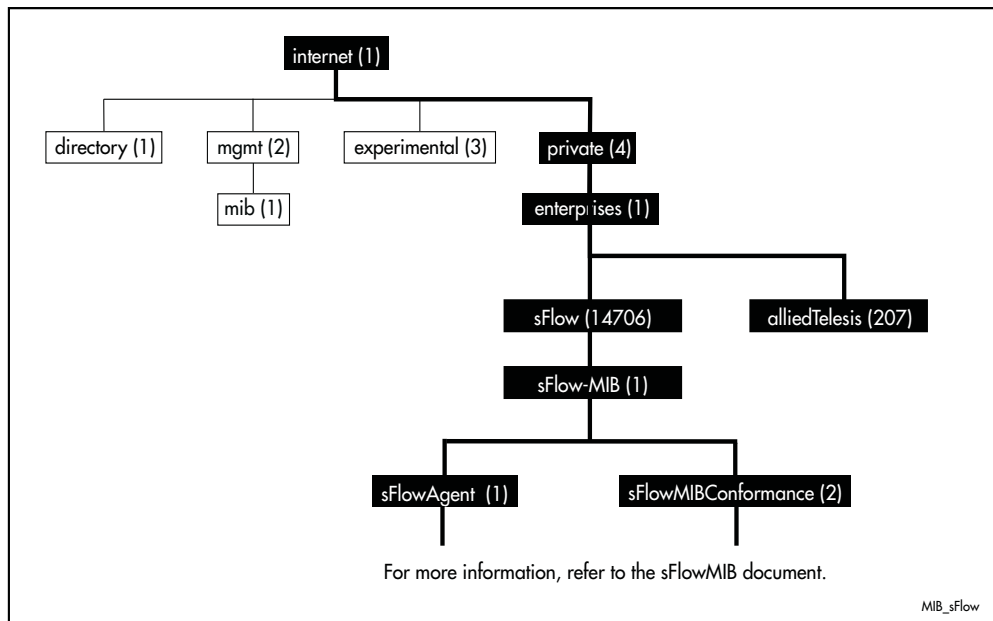

Chapter 80: LLDP Introduction



Introduction.....	80.2
Link Layer Discovery Protocol.....	80.2
LLDP-MED.....	80.3
Voice VLAN.....	80.4
LLDP Advertisements.....	80.4
Type-Length-Value (TLV).....	80.4
LLDP-MED: Location Identification TLV.....	80.7
Transmission and Reception.....	80.8
LLDP-MED Operation.....	80.9
Storing LLDP Information.....	80.10
Configuring LLDP.....	80.11
Configure LLDP.....	80.12
Configure LLDP-MED.....	80.14
Configure Authentication for Voice VLAN.....	80.18

Introduction

This chapter describes the Link Layer Discovery Protocol (LLDP), LLDP for Media Endpoint Devices (LLDP-MED) and Voice VLAN, and general configuration information for these.

LLDP is designed to be managed with the Simple Network Management Protocol (SNMP), and SNMP-based Network Management Systems (NMS). LLDP can be configured, and the information it provides can be accessed, using either the command line interface or SNMP.

- For detailed descriptions of the commands used to configure LLDP and LLDP-MED, see [Chapter 81, LLDP Commands](#).
- For Voice VLAN commands, see [Chapter 17, VLAN Commands](#).
- For information about the LLDP and LLDP-MED MIBs, see “Public MIBs” on page 79.61.

Link Layer Discovery Protocol

Link Layer Discovery Protocol (LLDP) is a Layer 2 protocol defined by the *IEEE Standard 802.1AB-2005*. This switch supports LLDP as specified in this standard, including *Annex F* and *Annex G*.

LLDP enables Ethernet network devices, such as switches and routers, to transmit and/or receive device-related information to or from directly connected devices on the network, and to store such information learned about other devices. The data sent and received by LLDP is useful for many reasons. The switch can discover neighbors—other devices directly connected to it. Devices can use LLDP to advertise some parts of their Layer 2 configuration to their neighbors, enabling some kinds of misconfiguration to be more easily detected and corrected.

LLDP is a link level (“one hop”) protocol; LLDP information can only be sent to and received from devices that are directly connected to each other, or connected via a hub or repeater. Advertised information is not forwarded on to other devices on the network.

The information transmitted in LLDP advertisements flows in one direction only, from one device to its neighbors, and the communication ends there. Transmitted advertisements do not solicit responses, and received advertisements do not solicit acknowledgement.

LLDP operates over physical ports (layer 2) only. For example, it can be configured on switch ports that belong to static or dynamic aggregated links (channel groups), but not on the aggregated links themselves; and on switch ports that belong to VLANs, but not on the VLANs themselves.

LLDP provides a way for the switch to:

- transmit information about itself to neighbors
- receive device information from neighbors
- store and manage information in an LLDP MIB

Each port can be configured to transmit local information, receive neighbor information, or both.

LLDP defines:

- a set of common advertisements (“[LLDP Advertisements](#)” on page 80.4)
- a protocol for transmitting and receiving advertisements (“[Transmission and Reception](#)” on page 80.8)
- a method for storing the information that is contained within received advertisements (“[Storing LLDP Information](#)” on page 80.10)

Interactions LLDP has the following interactions with other switch features:

- **Spanning tree**
Ports blocked by a spanning tree protocol can still transmit and receive LLDP advertisements.
- **802.1x**
Ports blocked by 802.1x port authorization cannot transmit or receive LLDP advertisements. If LLDP has stored information for a neighbor on the port before it was blocked, this information will eventually time out and be discarded.
- **VLAN tagging**
LLDP packets are untagged; they do not contain 802.1Q header information with VLAN identifier and priority tagging.
- **Virtual Chassis Stacking (VCStack) resiliency link**
When a port is configured as a VCStack resiliency link port, LLDP does not operate on the port; LLDP neither transmits nor receives advertisements, and any LLDP configuration and data stored for the port, including counters, is discarded.
- **Mirror ports**
LLDP does not operate on mirror analyzer ports.

LLDP-MED

LLDP for Media Endpoint Devices (LLDP-MED), is an extension of LLDP used between LAN network connectivity devices, such as this switch, and the media endpoint devices connected to them, such as IP phones. LLDP-MED is specified in *ANSI/TIA-1057-2006*. Of the application types specified in *ANSI/TIA-1057-2006*, the switch supports Application Type 1: Voice.

LLDP-MED uses the LLDP advertisement, transmission and storage mechanisms, but transmits, receives, and stores data specifically related to managing the voice endpoint devices. This includes information about network policy, location, hardware configuration, and, for Power over Ethernet-capable devices, power management.

Voice VLAN

Many IP phones (or other IP voice devices) have two interfaces: one to connect to the network and another that allows a computer or similar device to connect to the network via the IP phone. It is often desirable to treat the voice and data traffic separately so that appropriate Quality of Service (QoS) policies can be applied to each. The Voice VLAN feature uses LLDP-MED to convey configuration information (such as VLAN ID and User Priority tagging, and DiffServ Code Point (DSCP)—“[Differentiated Services Architecture](#)” on page 52.4) for the voice traffic to the IP phone. In response, the IP phone sends voice traffic according to this configuration. The data traffic coming through the IP phone from the PC is sent with the default configuration, typically untagged with normal priority.

LLDP Advertisements

LLDP transmits advertisements as packets called LLDP Data Units (LLDPDUs). An LLDPDU consists of a set of Type-Length-Value elements (TLV), each of which contains a particular type of information about the device or port transmitting it.

Type-Length-Value (TLV)

A single LLDPDU contains multiple TLVs. TLVs are short information elements that communicate complex data, such as variable length strings, in a standardized format. Each TLV advertises a single type of information, such as its device ID, type, or management addresses. The following table describes fields in a TLV.

Table 80-1: Fields in a Type Length Value element

Field	Description
Type	Identifies the kind of information. It consists of a 7-bit Type code.
Length	Identifies the length of the information. It consists of a 9-bit value that specifies the number of bytes of data in the Value field.
Value	Contains the actual value of the advertised information. This is a variable length data field.

LLDP sends mandatory TLVs in each advertisement; it can also be configured to send one or more optional TLVs, from the following groups:

- Mandatory Base TLVs, included in all LLDP advertisements. See IEEE 802.1AB-2005.
- Optional Base TLVs, which may be included in any LLDP advertisements. See IEEE 802.1AB-2005.
- IEEE 802.1 Organizationally Specific TLVs (802.1 TLVs). See IEEE 802.1AB-2005 Annex F.
- IEEE 802.3 Organizationally Specific TLVs (802.3 TLVs). See IEEE 802.1AB-2005 Annex G.
- LLDP-MED Organizationally Specific TLVs (LLDP-MED TLVs), included in LLDP-MED advertisements. See ANSI/TIA-1057- 2006.

Mandatory and optional TLVs for LLDP and LLDP-MED advertisements are shown in [Table 80-2](#).

Table 80-2: TLVs in LLDP advertisements

TLV	Description
Mandatory Base TLVs—IEEE 802.1AB-2005	
Chassis ID	Identifies the device's chassis. On this switch, this is the MAC address of the switch or stack.
Port ID	Identifies the port that transmitted the LLDPDU.
Time To Live (TTL)	Indicates the length of time in seconds for which the information received in the LLDPDU remains valid. If the value is greater than zero, the information is stored in the LLDP remote system MIB. If the value is zero, the information previously received is no longer valid, and is removed from the MIB.
End of LLDPDU	Signals that there are no more TLVs in the LLDPDU.
Optional Base TLVs—IEEE 802.1AB-2005	
Port description	A description of the device's port in alpha-numeric format.
System name	The system's assigned name in alpha-numeric format.
System description	A description of the device in alpha-numeric format. This includes information about the device's hardware and operating system.
System capabilities	The device's router and bridge functions, and whether or not these functions are currently enabled.
Management address	The address of the local LLDP agent. This can be used to obtain information related to the local device.
IEEE 802.1 Organizationally Specific TLVs (802.1 TLVs)—IEEE 802.1AB-2005 Annex F	
Port VLAN	VLAN identifier that the local port associates with untagged or priority tagged frames.
Port & Protocol VLANs	Whether Port & Protocol VLAN is supported and enabled on the port, and the list of Port & Protocol VLAN identifiers.
VLAN Names	List of VLAN names that the port is assigned to.
Protocol IDs	List of protocols that are accessible through the port, for instance: <ul style="list-style-type: none"> ■ 9000 (Loopback) ■ 00 26 42 42 03 00 00 00 (STP) ■ 00 27 42 42 03 00 00 02 (RSTP) ■ 00 69 42 42 03 00 00 03 (MSTP) ■ 888e01 (802.1x) ■ aa aa 03 00 e0 2b 00 bb (EPSR) ■ 88090101 (LACP) ■ 00540000e302 (Loop protection) ■ 0800 (IPv4) ■ 0806 (ARP) ■ 86dd (IPv6)

Table 80-2: TLVs in LLDP advertisements (cont.)

TLV	Description
IEEE 802.3 Organizationally Specific TLVs (802.3 TLVs)—IEEE 802.1AB-2005 Annex G	
MAC/PHY Configuration/Status	<p>The current values of the following for the port:</p> <ul style="list-style-type: none"> ■ Speed and duplex mode auto-negotiation support ■ Auto-negotiation status ■ PMD (physical media dependent) auto-negotiation advertised capability ■ Operational MAU type <p>This TLV is always included in LLDP-MED advertisements.</p>
Power Via MDI	<p>The power-via-MDI capabilities.</p> <p>On devices that are LLDP-MED and PoE-capable, we recommend using the Extended Power-via-MDI TLV instead of this TLV.</p>
Link Aggregation	<p>Whether the link is capable of being aggregated, whether it is currently in an aggregation and if in an aggregation, the port of the aggregation.</p>
Maximum Frame Size	<p>The maximum supported 802.3 frame size that the sending device is capable of receiving—larger frames will be dropped.</p>
LLDP-MED Organizationally Specific TLVs (LLDP-MED TLVs)—ANSI/TIA-1057- 2006	
LLDP-MED Capabilities	<p>Indicates an LLDP-MED capable device, and advertises which LLDP-MED TLVs are supported and enabled, and the device type. For this switch, the device type is Network Connectivity Device.</p> <p>An advertisement containing this TLV is an LLDP-MED advertisement.</p>
Network Policy	<p>Network policy information configured on the port for connected media endpoint devices. The switch supports Application Type 1: Voice, including the following network policy for connected voice devices to use for voice data:</p> <ul style="list-style-type: none"> ■ Voice VLAN ID ■ Voice VLAN User Priority tagging ■ Voice VLAN Diffserv Code Point (DSCP)
Location Identification	<p>Location information configured for the port, in one or more of the following formats:</p> <ul style="list-style-type: none"> ■ Civic address ■ Coordinate-based LCI ■ Emergency Location Identification Number (ELIN) <p>For more information, see “LLDP-MED: Location Identification TLV” on page 80.7.</p>
Extended Power-via-MDI	<p>For PoE-capable devices, this TLV includes:</p> <ul style="list-style-type: none"> ■ Power Type field: Power Sourcing Entity (PSE). ■ Power Source field: current power source, either Primary Power Source or Backup Power Source. ■ Power Priority field: power priority configured on the port. ■ Power Value field: In TLVs transmitted by a Power Sourcing Equipment (PSE) such as this switch, this advertises the power that the port can supply over a maximum length cable based on its current configuration (that is, it takes into account power losses over the cable). In TLVs received from Powered Device (PD) neighbors, the power value is the power the neighbor requests. <p>Available on devices that are PoE-capable.</p>

Table 80-2: TLVs in LLDP advertisements (cont.)

TLV	Description
Inventory Management TLV Set	<p>Includes the following TLVs, based on the current hardware platform and the software version, identical on every port on the switch:</p> <ul style="list-style-type: none"> ■ Hardware Revision ■ Firmware Revision ■ Software Revision ■ Serial Number ■ Manufacturer Name ■ Model Name ■ Asset ID <p>On Virtual Chassis Stacking devices, the inventory information is based on the current master.</p>

LLDP-MED: Location Identification TLV

Location information can be configured for each port, and advertised to remote devices, which can then transmit this information in calls; the location associated with voice devices is particularly important for emergency call services. All ports may be configured with the location of the switch, or each port may be configured with the location of the remote voice device connected to it.

The location information for a particular port can be configured using one or more of the following three data formats: coordinate-based, Emergency Location Identification Number (ELIN), and civic address. Up to one location of each type can be assigned to a port.

Location configuration information (LCI) in all configured data formats is transmitted in Location Identification TLVs. When LLDP receives a Location Identification TLV, it updates the remote entry in the LLDP-MED MIB with this information.

Co-ordinate LCI Coordinate-based location data format uses geospatial data, that is, latitude, longitude, and altitude (height or floors), including indications of resolution, with reference to a particular datum: WGS 84, NAD83—North American Vertical Datum of 1988 (NAVD88), or NAD83—Mean Lower Low Water (MLLW). For more information, see *RFC 3825, Dynamic Host Configuration Protocol Option for Coordinate-based Location Configuration Information*.

ELIN LCI Emergency Location Identification Number (ELIN) location data format provides a unique number for each location for Emergency Call Services (ECS). In North America, ELINs are typically 10 digits long; ELINs up to 25 digits are supported.

Civic Address LCI The Civic Address location data format uses common street address format, as described in *RFC4776*.

Transmission and Reception

Table 80-3 describes the LLDP transmission and reception processes. Additional LLDP-MED processes are described in “LLDP-MED Operation” on page 80.9.

Table 80-3: LLDP transmission and reception processes

When ...	And ...	Then ...
LLDP is enabled	Ports are configured to transmit LLDP advertisements	Regular LLDP advertisements are sent via these ports at intervals determined by the transmit interval. Each advertisement contains local information (from the Local Systems MIB) for all the mandatory TLVs and the optional TLVs that the port is configured to send.
	Ports are configured to receive LLDP advertisements	Information received in advertisements via these ports is stored in the Neighbor table (Remote Systems MIB). This information is retained until it is replaced by a more recent advertisement from the same neighbor or it times out (the TTL elapses).
Local information changes	The transmission delay time has elapsed since the last advertisement was transmitted	New advertisements are sent containing the new set of local information.
Neighbor information changes	Notifications are enabled, and the notification interval has elapsed since the last notification was sent	The SNMP notification (trap) lldpRemTablesChange is sent.
LLDP transmission and reception is disabled on a port.	An LLDP command was used to do this	It transmits a final 'shutdown' LLDPDU with a Time-To-Live (TTL) TLV that has a value of "0". This tells any remote neighboring devices to remove the information associated with this switch from their remote systems MIB. Then it stops transmitting and receiving advertisements. The neighbor information remains in the Remote Systems MIB until it times out.
	A shutdown command was used on the port	It makes a best effort to send a shutdown LLDPDU. Then it stops transmitting and receiving advertisements. The neighbor information remains in the Remote Systems MIB until it times out.
	Something else disabled LLDP, such as Virtual Chassis Stacking (VCS) failover	It does not send a shutdown LLDPDU. It stops transmitting and receiving advertisements. The neighbor information remains in the Remote Systems MIB until it times out.
	It is enabled again	LLDP reinitializes and resumes transmitting and receiving advertisements after the reinitialization interval has elapsed.
The Neighbor table has 1600 neighbors		It discards any further neighbors.
LLDP receives a LLDPDU or TLV with a detectable error		It discards the incorrect TLV.
LLDP receives a TLV it does not recognize	It contains no basic format errors	It stores it for possible later retrieval by network management (in the unrecognized TLV information table lldpRemUnknownTLVTable in the LLDP MIB).

LLDP-MED Operation

When LLDP is enabled, LLDP-MED is enabled by default, and uses the same LLDP transmission and reception process described in [Table 80-3](#). When LLDP receives an advertisement indicating a newly connected LLDP-MED-capable device on a port, it transmits one LLDP-MED advertisement per second via this port, a configurable number of times (the *fast start count*). Thereafter, it sends regular advertisements at the LLDP transmit interval. When the last advertisement for an LLDP-MED-capable device connected to the port times out, it stops sending LLDP-MED advertisements via the port.

If LLDP-MED notifications are enabled for a port, and SNMP traps for LLDP are enabled, LLDP-MED generates a *Topology Change Notification (LLDP-MED lldpXMedTopology ChangeDetected)* when a new LLDP-MED compliant IP telephony device is connected to a port or removed from a port. This notification includes the following information:

- IP Phone Chassis ID and Chassis ID sub-type (IP address)
- LLDP Endpoint Device Class
- Switch Chassis ID (MAC address) and Port ID where the device is attached.

Storing LLDP Information

When an LLDP device receives a valid LLDP advertisement from a neighboring network device, it stores the information in an IEEE-defined Simple Network Management Protocol (SNMP) Management Information Base (MIB).

LLDP stores information in the LLDP MIB defined in Section 12 of the *IEEE Standard 802.1AB-2005*, its extensions defined in *Annex F, Annex G*, and ANSI/TIA-1057- 2006, about:

LLDP-EXT-MED-MIB ANSI/TIA-1057- 2006, Section 13.3, LLDP-MED MIB Definition

- **Local system information.** This is the information that LLDP can transmit in advertisements to its neighbors.
- **Remote systems information.** This is the data that the device receives in advertisements from its neighbors.
- **LLDP configuration.** This can be used with SNMP to configure LLDP on the device.
- **LLDP statistics.** This includes information about LLDP operation on the device, including packet and event counters.

This information can be accessed either via SNMP, or directly using the command line interface.

Local system

Information about your device is called local system information. The LLDP local system MIB maintains this information, which consists of device details, as well as any user-configured information that you have set up for your switch, for example a port description or a management address.

LLDP on this device can store one management address per port, and transmit this in LLDP advertisements. It can store multiple management addresses received from each neighbor.

Remote systems

Information gained from neighboring devices is called remote system information. The LLDP remote systems MIB maintains this information.

The length of time for which neighbor information remains in the LLDP remote systems MIB is determined by the Time-To-Live (TTL) value of received LLDPDUs. When it receives an advertisement from a neighbor, LLDP starts a timer based on the Time To Live (TTL) information in the advertisement. The Time To Live (TTL) information in an advertisement is: $TTL = \text{transmit interval} \times \text{holdtime multiplier}$. If the TTL elapses, for instance if the neighbor has been removed, LLDP deletes the neighbor's information from the MIB. This ensures that only valid LLDP information is stored.

Whenever a new neighbor is discovered, or an existing neighbor sends an advertisement with new information that differs from the previous advertisement, for example a new or changed TLV, a remote tables change event is activated. If SNMP notifications are enabled, the notification `lldpRemTablesChange` is sent.

To prevent the remote systems MIB from using large amounts of memory and possibly affecting the operation of your switch, it limits the number of neighbors it stores information for to 1600. If it is storing information from 1600 neighbors, and detects any more neighbors, it is considered to have too many neighbors, and discards advertisements from the rest. There is no per-port limit to the number of neighbors.

SNMP utilities

An SNMP utility can read the Neighbors table MIB (Remote Systems Data in the LLDP MIB) on a device to find out about the LLDP neighbors it is directly connected to on each port. Then it can read the Neighbors table MIB on each of these neighbors to find out about their neighboring LLDP devices, and so on.

Configuring LLDP

You can configure LLDP on the device using either:

- the command line interface. For detailed descriptions of the commands, see [Chapter 81, LLDP Commands](#), or
- SNMP—see [Chapter 79, SNMP MIBs](#).

This section includes the following command line interface configuration procedures:

- [“Configure LLDP” on page 80.12](#)— This procedure includes configuration for LLDP between network connectivity devices; it does not include LLDP-MED. If you are configuring LLDP-MED only, use the following procedure instead of this one.
- [“Configure LLDP-MED” on page 80.14](#)—This procedure includes the LLDP configuration required to support LLDP-MED, as well as specific LLDP-MED and Voice VLAN configuration.
- [“Configure Authentication for Voice VLAN” on page 80.18](#)—This procedure includes 802.1X port authentication configuration including dynamic VLAN assignment to be used with LLDP-MED. Use the previous procedure before using this one.

Because LLDP is often used together with SNMP, consider configuring SNMP before you configure LLDP. LLDP transmits large amounts of data about the network. For security reasons, we recommend configuring SNMP for SNMP version 3 only (for read and write access). Remove all SNMPv1 and SNMPv2 configuration. See [Chapter 77, SNMP Introduction](#), and [Chapter 78, SNMP Commands](#).

Configure LLDP

Use the procedure in [Table 80-4](#) below to configure LLDP.

Some optional TLVs send information that can be configured by other commands. If LLDP will be configured to send these TLVs, consider whether to configure the corresponding parameters first.

- Port Description. See the [description \(interface\) command on page 12.2](#).
- System Name. See the [hostname command on page 8.17](#).

Table 80-4: Configuration procedure for LLDP

Enable LLDP	
1.	<code>awplus#configure terminal</code> Enter Configuration mode.
2.	<code>awplus(config)#lldp run</code> Enable LLDP.
Configure ports for LLDP	
Configure each port to determine whether and which LLDP messages are transmitted and received. If all the ports running LLDP require the same configuration, configure them all together. Otherwise repeat these commands for each port or group of ports that requires a particular configuration.	
3.	<code>awplus(config)# interface <port-list></code> Enter Interface Configuration mode for the switch ports.
4.	<code>awplus(config-if)#lldp tlv-select [<tlv>...]</code> <code>awplus(config-if)#lldp tlv-select all</code> By default, the mandatory TLVs are included in LLDP messages. Enable the transmission of one or more optional TLVs through these port as required.
5.	<code>awplus(config-if)#exit</code> Return to Global Configuration mode.
6.	<code>awplus(config)#interface <port-list></code> By default, transmission and reception of LLDP advertisements is enabled on all ports. Enter Interface Configuration mode for any switch ports that should have transmission or reception disabled.
7.	<code>awplus(config-if)#no lldp {[transmit] [receive]}</code> Disable transmission and/or reception as required.
8.	<code>awplus(config-if)#exit</code> Return to Global Configuration mode.
9.	<code>awplus(config)#exit</code> Return to Privileged Exec mode.
Check LLDP configuration	
10.	<code>awplus#show lldp</code> <code>awplus#show lldp interface [<port-list>]</code> <code>awplus#show lldp local-info [base] [dot1] [dot3] [med] [interface <port-list>]</code> <code>awplus#show running-config lldp</code> Review the LLDP configuration.
Monitor LLDP	
11.	<code>awplus#show lldp neighbors</code> <code>awplus#show lldp neighbors detail</code> <code>awplus#show lldp statistics</code> <code>awplus#show lldp statistics interface [<port-list>]</code> Monitor LLDP operations and display neighbor information as required.

Table 80-4: Configuration procedure for LLDP (cont.)

Advanced LLDP configuration

The configuration procedure above and the defaults for other settings suit most networks. Use the following commands for fine tuning if necessary.

Timer intervals should be long enough not to create unnecessarily high numbers of advertisements when there are topology changes. However, be aware that if the intervals are long, a neighbor's information can continue to be stored after its information has changed, or after it is disconnected.

12.	<code>awplus#configure terminal</code>	Enter Configuration mode.
13.	<code>awplus(config)#interface <port-list></code>	Enter Interface Configuration mode for the switch ports.
14.	<code>awplus(config-if)#lldp management-address <ipaddr></code>	Override the default LLDP management address advertised through this port if required. This must be an IPv4 address that is already configured on the device. To see the management address that will be advertised, use the show lldp local-info command on page 81.37 .
15.	<code>awplus(config-if)#lldp notifications</code>	By default, SNMP notifications are not transmitted. Enable them for these ports if required. (SNMP LLDP traps (notifications) must also be enabled.)
16.	<code>awplus(config-if)#exit</code>	Return to Global Configuration mode.
17.	<code>awplus(config)#lldp timer <5-32768></code>	The transmit interval determines how often regular LLDP transmits advertisements from each port. The transmit interval must be at least four times the transmission delay. Default: 30 seconds
18.	<code>awplus(config)#lldp notification-interval <5-3600></code>	The notification interval determines the minimum interval between sending SNMP notifications (traps). Default: 5 seconds
19.	<code>awplus(config)#lldp tx-delay <1-8192></code>	A series of successive changes over a short period of time can trigger the agent to send a large number of LLDPDUs. To prevent this, there is a transmission delay timer. This establishes a minimum length of time that must elapse between successive LLDP transmissions. The transmission delay cannot be greater than a quarter of the transmit interval. Default: 2 seconds
20.	<code>awplus(config)#lldp reinit <1-10></code>	Reinitialization delay timer determines the minimum time after disabling LLDP on a port before it can reinitialize. Default: 2 seconds
21.	<code>awplus(config)#lldp holdtime-multiplier <2-10></code>	The transmit interval is multiplied by the holdtime multiplier to give the Time To Live (TTL) value that is advertised to neighbors. Default: 4
22.	<code>awplus(config)#exit</code>	Return to Privileged Exec mode.

Clear data

If necessary, you can clear either neighbor information or LLDP statistics for particular ports or all ports.

23.	<code>awplus#clear lldp table [interface <port-list>]</code>	Clear the information from the table of neighbor information.
24.	<code>awplus#clear lldp statistics [interface <port-list>]</code>	Clear LLDP statistics (packet and event counters).

Configure LLDP-MED

Use the procedure in [Table 80-5](#) to configure LLDP-MED and Voice VLAN for voice devices connected to the switch.

Consider whether you also need to configure:

- Simple Network Management Protocol ([Chapter 78, SNMP Commands](#))
- 802.1X port authentication ([Chapter 55, 802.1X Commands](#), [Chapter 57, Authentication Commands](#), [Chapter 59, AAA Commands](#))
- RADIUS server ([Chapter 63, Local RADIUS Server Commands](#), or [Chapter 61, RADIUS Commands](#))
- Quality of Service ([Chapter 53, QoS Commands](#))
- Access Control Lists ([Chapter 50, IPv4 Access Control List \(ACL\) Commands](#))

In most cases, configuring LLDP-MED using SNMP or using the CLI command line interface (CLI) described in [Chapter 81, LLDP Commands](#) has the same effect. However, the effect of configuring location information using SNMP differs from the CLI. When location information is assigned to a port by SNMP and a matching location is not found on the device, then a new location is automatically created and assigned to the specified port. If the location is unset by SNMP later, then the location is removed to prevent accumulating SNMP-set location information. However, if the location is being used for other ports, the automatically created location is not removed until no ports use it. Once it is modified or assigned to other ports by CLI commands, the location remains even after no ports use the location.

Table 80-5: Configuration procedure for Voice VLAN and LLDP-MED

Configure a Voice VLAN	
Create a VLAN for voice data from voice endpoint devices connected to ports on the switch. Specify the network policy for voice data in this voice VLAN. LLDP-MED sends the network policy to voice devices connected to these ports. The voice devices use this network policy to determine the VLAN, priority and DSCP tagging of voice data it transmits.	
1. <code>awplus#configure terminal</code>	Enter Global Configuration mode.
2. <code>awplus(config)#vlan database</code>	Enter VLAN Database Configuration mode.
3. <code>awplus(config-vlan)#vlan <vid> [name <vlan-name>] [state {enable disable}]</code>	Create a VLAN to be used for the voice data to and from voice devices connected to the switch. By default, the new VLAN is enabled.
4. <code>awplus(config-vlan)#exit</code>	Return to global configuration mode.
5. <code>awplus(config)#interface <port-list></code>	Enter interface configuration mode for the ports to be configured with the same network policy. This may be all the switch ports with voice devices connected to them, or a subset if the network policy will differ between ports.
6. <code>awplus(config-if)#switchport voice vlan [<vid> dot1p dynamic untagged]</code>	Specify the VLAN tagging to be used for voice data on these ports. Use the dynamic option if the VLAN tagging will be allocated dynamically by a RADIUS server. To configure authentication and dynamic VLAN allocation using the local RADIUS server, see the procedure in Table 80-6 on page 80.18 . Default: none .

Table 80-5: Configuration procedure for Voice VLAN and LLDP-MED (cont.)

7.	<code>awplus(config-if)#switchport voice vlan priority <0-7></code>	Specify the priority-tagging that voice endpoint devices should put into their data packets. Default: 5.
8.	<code>awplus(config-if)#switchport voice dscp <0-63></code>	Specify the DSCP value that voice endpoint devices should put into their data packets. Default: 0.
9.	<code>awplus(config-if)#exit</code>	Return to global configuration mode.
Enable LLDP		
10.	<code>awplus(config)#lldp run</code>	Enable LLDP on the switch. Default: LLDP is disabled.
11.	<code>awplus(config)#interface <port-list></code>	Enter interface configuration mode for the switch ports LLDP is NOT to run on.
12.	<code>awplus(config-if)#no lldp {[transmit] [receive]}</code>	Disable transmission or reception on these ports as required. Default: transmit and receive enabled.
13.	<code>awplus(config-if)#exit</code>	Return to global configuration mode.
Configure LLDP-MED location information		
Create civic address, coordinate, and/or ELIN locations, and assign them to switch ports.		
14.	<code>awplus(config)#location civic-location identifier <civic-loc-id></code>	Specify a civic location ID, and enter configuration mode for this identifier.
15.	<code>awplus(config-civic)#country <country></code> <code>awplus(config-civic)#city <city></code> <code>awplus(config-civic)#primary-road-name <primary-road-name></code> <code>awplus(config-civic)#street-suffix <street-suffix></code> <code>awplus(config-civic)#house-number <house-number></code> <code>awplus(config-civic)#<other-civic-location-parameters ...></code>	Specify the civic address location information for the civic address location ID. You must specify a country first, using the upper-case two-letter country code, and then at least one more parameter. For the full set of parameters you can use to specify civic address location, see the location civic-location configuration command on page 81.21 .
16.	<code>awplus(config-civic)#exit</code>	Return to global configuration mode.
17.	<code>awplus(config)#location coord-location identifier <coord-loc-id></code>	Specify a coordinate location identifier, and enter configuration mode for this identifier.
18.	<code>awplus(config-coord)#latitude <latitude></code> <code>awplus(config-coord)#lat-resolution <lat-resolution></code> <code>awplus(config-coord)#longitude <longitude></code> <code>awplus(config-coord)#long-resolution <long-resolution></code> <code>awplus(config-coord)#altitude <altitude> {meters floor}</code> <code>awplus(config-coord)#alt-resolution <alt-resolution></code> <code>awplus(config-coord)#datum {wgs84 nad83-navd nad83-mlw}</code>	Specify the coordinate location for the coordinate location identifier.
19.	<code>awplus(config-coord)#exit</code>	Return to global configuration mode.
20.	<code>awplus(config)#location elin-location <elin> identifier <elin-loc-id></code>	Specify an ELIN location identifier, and the ELIN for this identifier.

Table 80-5: Configuration procedure for Voice VLAN and LLDP-MED (cont.)

21.	<code>awplus(config)#interface <port-list></code>	Enter interface configuration mode for one or more switch ports which require the same location information.
22.	<code>awplus(config-if)#location civic-location-id <civic-loc-id></code> <code>awplus(config-if)#location coord-location-id <coord-loc-id></code> <code>awplus(config-if)#location elin-location-id <elin-loc-id></code>	Assign the civic, coordinate, and/or ELIN location identifier to these ports. LLDP-MED will send the location information associated with a port to the voice endpoint device attached to it.
23.	<code>awplus(config-if)#exit</code>	Return to global configuration mode.
24.	<code>awplus(config)#exit</code>	Return to Privileged Exec mode.
Review the LLDP configuration		
25.	<code>awplus#show lldp</code>	Check general LLDP configuration settings.
26.	<code>awplus#show lldp interface [<port-list>]</code>	Check LLDP configuration for ports.
27.	<code>awplus#show lldp local-info [base] [dot1] [dot3] [med] [interface <port-list>]</code>	Check the information that may be transmitted in LLDP advertisements from ports.
28.	<code>awplus#show location {civic-location coord-location elin-location}</code> <code>awplus#show location {civic-location coord-location elin-location} identifier {<civic-loc-id> <coord-loc-id> <elin-loc-id>}</code> <code>awplus#show location {civic-location coord-location elin-location} interface <port-list></code>	Check the location information.
29.	<code>awplus#show running-config lldp</code>	If you want to display all the LLDP configuration, use this command.
Monitor LLDP-MED		
30.	<code>awplus#show lldp neighbors [interface <port-list>]</code> <code>awplus#show lldp neighbors detail [base] [dot1] [dot3] [med] [interface <port-list>]</code> <code>awplus#show lldp statistics</code> <code>awplus#show lldp statistics interface [<port-list>]</code>	Monitor LLDP operation.
Advanced configuration		
The configuration procedure above and the defaults for other settings suit most networks. Use the following commands for fine tuning if necessary. For information about other advanced configuration for LLDP, including LLDP timers, see Table 80-4 .		
31.	<code>awplus#configure terminal</code>	Enter Global Configuration mode.
32.	<code>awplus(config)#lldp faststart-count <1-10></code>	By default, when LLDP-MED detects an LLDP-MED capable device on a port, it sends 3 advertisements at 1s intervals. Change the fast start count if required. Default: fast start count is 3
33.	<code>awplus(config)#lldp non-strict-med-tlv-order-check</code>	By default non-strict order checking for LLDP-MED advertisements is disabled. That is, strict order checking is applied to LLDP-MED advertisements, and LLDP-MED TLVs in non-standard order are discarded. If you require LLDP-MED advertisements with non-standard TLV order to be received and stored, enable non-strict order checking.

Table 80-5: Configuration procedure for Voice VLAN and LLDP-MED (cont.)

34.	<code>awplus(config)#interface <port-list></code>	Enter interface configuration mode for switch ports which will have the same advanced configuration.
35.	<code>awplus(config-if)#lldp management-address <ipaddr></code>	Override the default LLDP management address advertised through this port if required. This must be an IPv4 address that is already configured on the device. To see the management address that will be advertised, use the show lldp local-info command on page 81.37.
36.	<code>awplus(config-if)#lldp med-notifications</code>	By default, SNMP notifications are not transmitted. Enable LLDP-MED Topology Change Detected notifications for these ports if required. (SNMP LLDP traps (notifications) must also be enabled.) Default: LLDP-MED notifications disabled
37.	<code>awplus(config-if)#lldp tlv-select {[<tlv>]...}</code>	Enable the transmission of one or more optional LLDP TLVs in LLDP-MED advertisements through this port as required. The mac-phy-config TLV is transmitted in LLDP-MED advertisements whether or not it is enabled by this command. Default: all mandatory TLVs are enabled.
38.	<code>awplus(config-if)#lldp med-tlv-select</code> <code>{[capabilities] [network-policy] [location]</code> <code>[inventory-management]}</code> <code>awplus(config-if)#lldp med-tlv-select all</code> <code>awplus(config-if)#no lldp med-tlv-select</code> <code>{[capabilities] [network-policy] [location]</code> <code>[inventory-management]}</code> <code>awplus(config-if)#no lldp med-tlv-select all</code>	Enable or disable the transmission of optional LLDP-MED TLVs in LLDP-MED advertisements through these ports as required. Default: capabilities , network-policy , location , power-management are enabled.
39.	<code>awplus(config-if)#exit</code>	Return to global configuration mode.
40.	<code>awplus(config)#exit</code>	Return to privileged exec mode.
Clear data		
If necessary, you can clear either neighbor information or LLDP statistics for particular ports or all ports.		
41.	<code>awplus#clear lldp table [interface <port-list>]</code>	Clear the information from the table of neighbor information.
42.	<code>awplus#clear lldp statistics [interface <port-list>]</code>	Clear LLDP statistics (packet and event counters).

Configure Authentication for Voice VLAN

Use the following procedure with LLDP-MED and Voice VLAN to configure 802.1X port authentication and dynamic VLAN assignment using the local RADIUS server on the switch to which the voice endpoint devices are connected.

This procedure assumes that you have already:

- configured Voice VLAN and LLDP-MED using the procedure in [Table 80-5 on page 80.14](#)
- set `switchport voice vlan` to `dynamic` in the above procedure

This procedure configures the local RADIUS server. If your configuration uses one or more remote RADIUS servers instead, set the IP addresses of the remote RADIUS servers using the `radius-server host` command ([Step 3 on page 18](#)), and skip all the steps that configure the local RADIUS server ([Step 3 on page 18](#) to [Step 14 on page 19](#)).

Table 80-6: Configuration procedure for Voice VLAN with RADIUS authentication and dynamic VLAN

Configure the IP address of the RADIUS host.	
1.	<code>awplus#configure terminal</code> Enter Global Configuration mode.
2.	<code>awplus(config)#radius-server host 127.0.0.1 key <key-string></code> Configure the IP address for the RADIUS server to be the local loopback address, so that RADIUS requests are sent to the local RADIUS server. Set the key that Network Access Servers (NAS) will need to use to get access to this RADIUS server. RADIUS server hosts configured using this command are included in the default RADIUS server group.
Enable the local RADIUS server.	
3.	<code>awplus(config)#radius-server local</code> Enter RADIUS Server Configuration mode.
4.	<code>awplus(config-radsrv)#server enable</code> Enable the local RADIUS server.
5.	<code>awplus(config-radsrv)#nas 127.0.0.1 key <key-string></code> Set the switch as a client device (Network Access Server), to allow it to send authentication requests to the local RADIUS server. Use the same loopback IP address and key as in the radius-server host command used in Step 2 on page 18 .
Configure a local RADIUS user group for connected PCs.	
6.	<code>awplus(config-radsrv)#group <user-group-name></code> Create a local RADIUS server user group for PCs connected to the switch, and enter RADIUS Server Group Configuration mode.
7.	<code>awplus(config-radsrv-group)#vlan {<vid> <vlan-name>}</code> Set the VLAN ID for the user group. This will assign the untagged VLAN ID to authenticated ports for PCs connected to the switch. To create multiple user groups for PCs with different VLANs, repeat these two steps.
8.	<code>awplus(config-radsrv-group)#exit</code> Return to RADIUS Server Configuration mode.
Configure a local RADIUS user group for connected phones.	
9.	<code>awplus(config-radsrv)#group <user-group-name></code> Create a new local RADIUS server user group for phones connected to the switch, and enter RADIUS Server Group Configuration mode.

Table 80-6: Configuration procedure for Voice VLAN with RADIUS authentication and dynamic VLAN (cont.)

10.	<code>awplus(config-radsrv-group)#vlan {<vid> <vlan-name>}</code>	Configure the local RADIUS user group for connected phones to use the same VLAN as the PCs in Step 7 , so that the phones have access to the same untagged VLAN as the PCs.
11.	<code>awplus(config-radsrv-group)#egress-vlan-id <vid> tagged</code>	Set the Egress-VLAN ID attribute for the user group, and set it to send tagged frames. This will assign the tagged VLAN ID to authenticated ports for phones connected to the switch. To create multiple user groups for phones with different VLANs, repeat these two steps.
12.	<code>awplus(config-radsrv-group)#exit</code>	Return to RADIUS Server Configuration mode.
Add users to the local RADIUS server.		
13.	<code>awplus(config-radsrv)#user <radius-user-name> password <user-password> group <user-group></code>	Add RADIUS user names and passwords to the local RADIUS server for authenticating PCs and phones. Assign the corresponding RADIUS server user groups configured in Step 6 and Step 9 . See the user (RADIUS server) command on page 63.35 .
14.	<code>awplus(config-radsrv)#exit</code>	Return to Global Configuration mode.
Create VLANs.		
15.	<code>awplus(config)#vlan database</code>	Enter VLAN Database Configuration mode.
16.	<code>awplus(config-vlan)#vlan <vid-range></code>	Create the VLANs corresponding to the VLAN IDs that will be allocated to the authenticated ports, as configured in Step 7 , Step 10 , and Step 11 .
17.	<code>awplus(config-vlan)#exit</code>	Return to Global Configuration mode.
Configure 802.1X port authentication.		
18.	<code>awplus(config)#aaa authentication dot1x default group radius</code>	Enable 802.1X port authentication and set it to use the default group of RADIUS servers that contains all RADIUS server hosts configured using the radius-server host command—in this procedure, the default group consists of the local RADIUS server.
19.	<code>awplus(config)#interface <port-list></code>	Enter interface configuration mode for the ports that have users (PCs and phones) connected to them.
20.	<code>awplus(config-if)#dot1x port-control auto</code>	Enable 802.1X for port authentication on these ports.
21.	<code>awplus(config-if)#auth host-mode multi-suplicant</code>	Configure the ports to use multi-suplicant mode for authentication, so that the phone and PC can be dynamically allocated to different VLANs.
22.	<code>awplus(config-if)#auth dynamic-vlan-creation</code>	Configure the ports to accept dynamic VLAN allocation. In this procedure, the RADIUS server user groups for both the PCs and the phones use the same VLAN (Step 7 and Step 10), so the default rule (deny) allows them both the access they need to the port VLAN. For other options, see the auth dynamic-vlan-creation command on page 57.6 . Default: deny differently assigned VLAN IDs.
23.	<code>awplus(config-if)#exit</code>	Return to Global Configuration mode.
24.	<code>awplus(config)#exit</code>	Return to Privileged Exec mode.

Table 80-6: Configuration procedure for Voice VLAN with RADIUS authentication and dynamic VLAN (cont.)

Review the authentication configuration.

- | | | |
|-----|--|--|
| 25. | <code>awplus#show radius local-server group [<user-group-name>]</code>
<code>awplus#show radius local-server nas [<ip-address>]</code>
<code>awplus#show radius local-server user [<user-name>]</code> | Check the local RADIUS server configuration. |
| 26. | <code>awplus#show vlan {all brief dynamic static <1-4094>}</code> | Check the VLAN configuration. |
| 27. | <code>awplus#show dot1x [all]</code> | Check the 802.1X authentication configuration. |
-

Chapter 81: LLDP Commands



Introduction.....	81.2
Command List.....	81.2
clear lldp statistics.....	81.2
clear lldp table.....	81.3
debug lldp.....	81.4
lldp faststart-count.....	81.5
lldp holdtime-multiplier.....	81.6
lldp management-address.....	81.7
lldp med-notifications.....	81.8
lldp med-tlv-select.....	81.9
lldp non-strict-med-tlv-order-check.....	81.11
lldp notification-interval.....	81.12
lldp notifications.....	81.13
lldp reinit.....	81.14
lldp run.....	81.15
lldp timer.....	81.16
lldp tlv-select.....	81.17
lldp transmit receive.....	81.19
lldp tx-delay.....	81.20
location civic-location configuration.....	81.21
location civic-location identifier.....	81.25
location civic-location-id.....	81.26
location coord-location configuration.....	81.27
location coord-location identifier.....	81.29
location coord-location-id.....	81.30
location elin-location.....	81.31
location elin-location-id.....	81.32
show debugging lldp.....	81.33
show lldp.....	81.34
show lldp interface.....	81.35
show lldp local-info.....	81.37
show lldp neighbors.....	81.41
show lldp neighbors detail.....	81.43
show lldp statistics.....	81.46
show lldp statistics interface.....	81.48
show location.....	81.50

Introduction

LLDP and LLDP-MED can be configured using the commands in this chapter, or by using SNMP with the LLDP-MIB and LLDP-EXT-DOT1-MIB (“Public MIBs” on page 79.61). The Voice VLAN feature can be configured using commands in [Chapter 17, VLAN Commands](#). For more information about LLDP, see [Chapter 80, LLDP Introduction](#).

LLDP can transmit a lot of data about the network. Typically, the network information gathered using LLDP is transferred to a Network Management System by SNMP. For security reasons, we recommend using SNMPv3 for this purpose ([Chapter 77, SNMP Introduction](#), [Chapter 78, SNMP Commands](#)).

LLDP operates over physical ports only. For example, it can be configured on switch ports that belong to static or dynamic channel groups, but not on the channel groups themselves.

Command List

This chapter contains an alphabetical list of commands used to configure LLDP.

clear lldp statistics

This command clears all LLDP statistics (packet and event counters) associated with specified ports. If no port list is supplied, LLDP statistics for all ports are cleared.

Syntax `clear lldp statistics [interface <port-list>]`

Parameter	Description
<port-list>	The ports for which the statistics are to be cleared.

Mode Privileged Exec

Examples To clear the LLDP statistics for ports 1.0.1 and 1.0.7, use the command:

```
awplus# clear lldp statistics interface port1.0.1,port1.0.7
```

To clear all LLDP statistics for all ports, use the command:

```
awplus# clear lldp statistics
```

Related Commands [show lldp statistics](#)
[show lldp statistics interface](#)

clear lldp table

This command clears the table of LLDP information received from neighbors through specified ports. If no port list is supplied, neighbor information is cleared for all ports.

Syntax `clear lldp table [interface <port-list>]`

Parameter	Description
<code><port-list></code>	The ports for which the neighbor information table is to be cleared.

Mode Privileged Exec

Examples To clear the table of neighbor information received through ports 1.0.1 and 1.0.7, use the command:

```
awplus# clear lldp table interface port1.0.1,port1.0.7
```

To clear the entire table of neighbor information received through all ports, use the command:

```
awplus# clear lldp table
```

Related Commands [show lldp neighbors](#)

debug lldp

This command enables specific LLDP debug for specified ports. When LLDP debugging is enabled, diagnostic messages are entered into the system log. If no port list is supplied, the specified debugging is enabled for all ports.

The **no** variant of this command disables specific LLDP debug for specified ports. If no port list is supplied, the specified debugging is disabled for all ports.

Syntax

```
debug lldp {[rx][rxpkt][tx][txpkt]} [interface [<port-list>]]
debug lldp operation
no debug lldp {[rx][rxpkt][tx][txpkt]} [interface [<port-list>]]
no debug lldp operation
no debug lldp all
```

Parameter	Description
rx	LLDP receive debug.
rxpkt	Raw LLDPDUs received in hex format.
tx	LLDP transmit debug.
txpkt	Raw Tx LLDPDUs transmitted in hex format.
<port-list>	The ports for which debug is to be configured.
operation	Debug for LLDP internal operation on the switch.
all	Disables all LLDP debugging for all ports.

Default By default no debug is enabled for any ports.

Mode Privileged Exec

Examples To enable debugging of LLDP receive on ports 1.0.1 and 1.0.7, use the command:

```
awplus# debug lldp rx interface port1.0.1,port1.0.7
```

To enable debugging of LLDP transmit with packet dump on all ports, use the command:

```
awplus# debug lldp tx txpkt
```

To disable debugging of LLDP receive on ports 1.0.1 and 1.0.7, use the command:

```
awplus# no debug lldp rx interface port1.0.1,port1.0.7
```

To turn off all LLDP debugging on all ports, use the command:

```
awplus# no debug lldp all
```

Related Commands [show debugging lldp](#)
[show running-config lldp](#)
[terminal monitor](#)

lldp faststart-count

Use this command to set the fast start count for LLDP-MED. The fast start count determines how many fast start advertisements LLDP sends from a port when it starts sending LLDP-MED advertisements from the port, for instance, when it detects a new LLDP-MED capable device.

The **no** variant of this command resets the LLDP-MED fast start count to the default (3).

Syntax `lldp faststart-count <1-10>`
`no lldp faststart-count`

Parameter	Description
<code><1-10></code>	The number of fast start advertisements to send.

Default The default fast start count is 3.

Mode Global Configuration

Examples To set the fast start count to 5, use the command:

```
awplus# configure terminal
awplus(config)# lldp faststart-count 5
```

To reset the fast start count to the default setting (3), use the command:

```
awplus# configure terminal
awplus(config)# no lldp faststart-count
```

Related Commands [show lldp](#)

lldp holdtime-multiplier

This command sets the holdtime multiplier value. The transmit interval is multiplied by the holdtime multiplier to give the Time To Live (TTL) value that is advertised to neighbors.

The **no** variant of this command sets the multiplier back to its default value.

Syntax `lldp holdtime-multiplier <2-10>`
`no lldp holdtime-multiplier`

Parameter	Description
<2-10>	The multiplier factor.

Default The default holdtime multiplier value is 4.

Mode Global Configuration

Usage The Time-To-Live defines the period for which the information advertised to the neighbor is valid. If the Time-To-Live expires before the neighbor receives another update of the information, then the neighbor discards the information from its database.

Examples To set the holdtime multiplier to 2, use the commands:

```
awplus# configure terminal
awplus(config)# lldp holdtime-multiplier 2
```

To set the holdtime multiplier back to its default value, use the commands:

```
awplus# configure terminal
awplus(config)# no lldp holdtime-multiplier 2
```

Related Commands [show lldp](#)

lldp management-address

This command sets the IPv4 address to be advertised to neighbors (in the Management Address TLV) via the specified ports. This address will override the default address for these ports.

The **no** variant of this command clears the user-configured management IP address advertised to neighbors via the specified ports. The advertised address reverts to the default.

Syntax `lldp management-address <ipaddr>`
`no lldp management-address`

Parameter	Description
<code><ipaddr></code>	The IPv4 address to be advertised to neighbors, in dotted decimal format. This must be one of the IP addresses already configured on the device.

Default The loopback interface primary IPv4 address if set, else the primary IPv4 interface address of the lowest numbered VLAN the port belongs to, else the MAC address of the device's baseboard if no VLAN IP addresses are configured for the port.

Mode Interface Configuration

Usage To see the management address that will be advertised, use the [show lldp interface command on page 81.35](#) or [show lldp local-info command on page 81.37](#).

Examples To set the management address advertised by ports 1.0.1 and 1.0.7, to be 192.168.1.6, use the commands:

```
awplus# configure terminal
awplus(config)# interface port1.0.1,port1.0.7
awplus(config-if)# lldp management-address 192.168.1.6
```

To clear the user-configured management address advertised by ports 1.0.1 and 1.0.7, and revert to using the default address, use the commands:

```
awplus# configure terminal
awplus(config)# interface port1.0.1,port1.0.7
awplus(config-if)# no lldp management-address
```

Related Commands [show lldp interface](#)
[show lldp local-info](#)

lldp med-notifications

Use this command to enable LLDP to send LLDP-MED Topology Change Detected SNMP notifications relating to the specified ports. The switch sends an SNMP event notification when a new LLDP-MED compliant IP Telephony device is connected to or disconnected from a port on the switch.

Use the **no** variant of this command to disable the sending of LLDP-MED Topology Change Detected notifications relating to the specified ports.

Syntax `lldp med-notifications`
`no lldp med-notifications`

Default The sending of LLDP-MED notifications is disabled by default.

Mode Interface Configuration

Examples To enable the sending of LLDP-MED Topology Change Detected notifications relating to ports 1.0.1 and 1.0.7, use the commands:

```
awplus# configure terminal
awplus(config)# interface port1.0.1,port1.0.7
awplus(config-if)# lldp med-notifications
```

To disable the sending of LLDP-MED notifications relating to ports 1.0.1 and 1.0.7, use the commands:

```
awplus# configure terminal
awplus(config)# interface port1.0.1,port1.0.7
awplus(config-if)# no lldp med-notifications
```

Related Commands [lldp notification-interval](#)
[lldp notifications](#)
[snmp-server enable trap](#)
[show lldp interface](#)

lldp med-tlv-select

Use this command to enable LLDP-MED Organizationally Specific TLVs for transmission in LLDP advertisements via the specified ports. The LLDP-MED Capabilities TLV must be enabled before any of the other LLDP-MED Organizationally Specific TLVs are enabled.

Use the **no** variant of this command to disable the specified LLDP-MED Organizationally Specific TLVs for transmission in LLDP advertisements via these ports. In order to disable the LLDP-MED Capabilities TLV, you must also disable the rest of these TLVs. Disabling all these TLVs disables LLDP-MED advertisements.

Syntax

```
lldp med-tlv-select {[capabilities] [network-policy] [location]
[inventory-management]}

lldp med-tlv-select all

no lldp med-tlv-select {[capabilities] [network-policy] [location]
[inventory-management]}

no lldp med-tlv-select all
```

Parameter	Description
capabilities	LLDP-MED Capabilities TLV. When this is enabled, the MAC/PHY Configuration/Status TLV from IEEE 802.3 Organizationally Specific TLVs is also automatically included in LLDP-MED advertisements, whether or not it has been explicitly enabled by the lldp tlv-select command.
network-policy	Network Policy TLV. This TLV is transmitted if Voice VLAN parameters have been configured using the commands: <ul style="list-style-type: none"> ■ switchport voice dscp ■ switchport voice vlan ■ switchport voice vlan priority
location	Location Identification TLV. This TLV is transmitted if location information has been configured using the commands: <ul style="list-style-type: none"> ■ location elin-location-id ■ location civic-location identifier ■ location civic-location configuration ■ location coord-location identifier ■ location coord-location configuration ■ location elin-location
inventory-management	Inventory Management TLV Set, including the following TLVs: <ul style="list-style-type: none"> ■ Hardware Revision ■ Firmware Revision ■ Software Revision ■ Serial Number ■ Manufacturer Name ■ Model Name ■ Asset ID
all	All LLDP-MED Organizationally Specific TLVs.

Default By default LLDP-MED Capabilities, Network Policy, Location Identification and Extended

Power-via-MDI TLVs are enabled. Therefore, if LLDP is enabled using the `lldp run` command, by default LLDP-MED advertisements are transmitted on ports that detect LLDP-MED neighbors connected to them.

Mode Interface Configuration

Usage LLDP-MED TLVs are only sent in advertisements via a port if there is an LLDP-MED-capable device connected to it. To see whether there are LLDP-MED capable devices connected to the ports, use the [show lldp neighbors command on page 81.41](#).

Examples To enable inclusion of the Inventory TLV Set in advertisements transmitted via ports 1.0.1 and 1.0.7, use the commands:

```
awplus# configure terminal
awplus(config)# interface port1.0.1,port1.0.7
awplus(config-if)# lldp med-tlv-select inventory-management
```

To exclude the Inventory TLV Set in advertisements transmitted via ports 1.0.1 and 1.0.7, use the commands:

```
awplus# configure terminal
awplus(config)# interface port1.0.1,port1.0.7
awplus(config-if)# no lldp med-tlv-select inventory-management
```

To disable LLDP-MED advertisements transmitted via ports 1.0.1 and 1.0.7, disable all these TLVs using the commands:

```
awplus# configure terminal
awplus(config)# interface port1.0.1,port1.0.7
awplus(config-if)# no lldp med-tlv-select all
```

Related Commands

- [lldp tlv-select](#)
- [location elin-location-id](#)
- [location civic-location identifier](#)
- [location civic-location configuration](#)
- [location coord-location identifier](#)
- [location coord-location configuration](#)
- [location elin-location](#)
- [show lldp interface](#)
- [switchport voice dscp](#)
- [switchport voice vlan](#)
- [switchport voice vlan priority](#)

lldp non-strict-med-tlv-order-check

Use this command to enable non-strict order checking for LLDP-MED advertisements it receives. That is, use this command to enable LLDP to receive and store TLVs from LLDP-MED advertisements even if they do not use standard TLV order.

Use the **no** variant of this command to disable non-strict order checking for LLDP-MED advertisements, that is, to set strict TLV order checking, so that LLDP discards any LLDP-MED TLVs that occur before the LLDP-MED Capabilities TLV in an advertisement.

Syntax `lldp non-strict-med-tlv-order-check`
`no lldp non-strict-med-tlv-order-check`

Default By default TLV non-strict order checking for LLDP-MED advertisements is disabled. That is, strict order checking is applied to LLDP-MED advertisements, according to ANSI/TIA-1057, and LLDP-MED TLVs in non-standard order are discarded.

Mode Global Configuration

Usage The ANSI/TIA-1057 specifies standard order for TLVs in LLDP-MED advertisements, and specifies that if LLDP receives LLDP advertisements with non-standard LLDP-MED TLV order, the TLVs in non-standard order should be discarded. This implementation of LLDP-MED follows the standard: it transmits TLVs in the standard order, and by default discards LLDP-MED TLVs that occur before the LLDP-MED Capabilities TLV in an advertisement. However, some implementations of LLDP transmit LLDP-MED advertisements with non-standard TLV order. To receive and store the data from these non-standard advertisements, enable non-strict order checking for LLDP-MED advertisements using this command.

Examples To enable strict TLV order checking, use the commands:

```
awplus# configure terminal
awplus(config)# lldp tlv-order-check
```

To disable strict TLV order checking, use the commands:

```
awplus# configure terminal
awplus(config)# no lldp tlv-order-check
```

Related Commands `show running-config lldp`

lldp notification-interval

This command sets the notification interval. This is the minimum interval between LLDP SNMP notifications (traps) of each kind (LLDP Remote Tables Change Notification and LLDP-MED Topology Change Notification).

The **no** variant of this command sets the notification interval back to its default value.

Syntax `lldp notification-interval <5-3600>`
`no lldp notification-interval`

Parameter	Description
<5-3600>	The interval in seconds

Default The default notification interval is 5 seconds.

Mode Global Configuration

Examples To set the notification interval to 20 seconds, use the commands:

```
awplus# configure terminal
awplus(config)# lldp notification-interval 20
```

To set the notification interval back to its default value, use the commands:

```
awplus# configure terminal
awplus(config)# no lldp notification-interval
```

Related Commands [lldp notifications](#)
[show lldp](#)

lldp notifications

This command enables the sending of LLDP SNMP notifications (traps) relating to specified ports.

The **no** variant of this command disables the sending of LLDP SNMP notifications for specified ports.

Syntax `lldp notifications`
`no lldp notifications`

Default The sending of LLDP SNMP notifications is disabled by default.

Mode Interface Configuration

Examples To enable sending of LLDP SNMP notifications for ports 1.0.1 and 1.0.7, use the commands:

```
awplus# configure terminal
awplus(config)# interface port1.0.1,port1.0.7
awplus(config-if)# lldp notifications
```

To disable sending of LLDP SNMP notifications for ports 1.0.1 and 1.0.7, use the commands:

```
awplus# configure terminal
awplus(config)# interface port1.0.1,port1.0.7
awplus(config-if)# no lldp notifications
```

Related Commands [lldp notification-interval](#)
[show lldp interface](#)
[snmp-server enable trap](#)

lldp reinit

This command sets the value of the reinitialization delay. This is the minimum time after disabling LLDP on a port before it can reinitialize.

The **no** variant of this command sets the reinitialization delay back to its default setting.

Syntax `lldp reinit <1-10>`

`no lldp reinit`

Parameter	Description
<1-10>	The delay in seconds

Default The default reinitialization delay is 2 seconds.

Mode Global Configuration

Examples To set the reinitialization delay to 3 seconds, use the commands:

```
awplus# configure terminal
awplus(config)# lldp reinit 3
```

To set the reinitialization delay back to its default value, use the commands:

```
awplus# configure terminal
awplus(config)# no lldp reinit
```

Related Commands [show lldp](#)

lldp run

This command enables the operation of LLDP on the device.

The **no** variant of this command disables the operation of LLDP on the device. The LLDP configuration remains unchanged.

Syntax `lldp run`

`no lldp run`

Default LLDP is disabled by default.

Mode Global Configuration

Examples To enable LLDP operation, use the commands:

```
awplus# configure terminal
awplus(config)# lldp run
```

To disable LLDP operation, use the commands:

```
awplus# configure terminal
awplus(config)# no lldp run
```

Related Commands [show lldp](#)

lldp timer

This command sets the value of the transmit interval. This is the interval between regular transmissions of LLDP advertisements.

The **no** variant of this command sets the transmit interval back to its default value.

Syntax `lldp timer <5-32768>`
`no lldp timer`

Parameter	Description
<code><5-32768></code>	The transmit interval in seconds. The transmit interval must be at least four times the transmission delay timer (lldp tx-delay command on page 81.20).

Default The default transmit interval is 30 seconds.

Mode Global Configuration

Examples To set the transmit interval to 90 seconds, use the commands:

```
awplus# configure terminal
awplus(config)# lldp timer 90
```

To set the transmit interval back to its default value, use the commands:

```
awplus# configure terminal
awplus(config)# no lldp timer
```

Related Commands [lldp tx-delay](#)
[show lldp](#)

lldp tlv-select

This command enables one or more optional TLVs, or all TLVs, for transmission in LLDP advertisements via the specified ports. The TLVs can be specified in any order; they are placed in LLDP frames in a fixed order (as described in IEEE 802.1AB). The mandatory TLVs (Chassis ID, Port ID, Time To Live, End of LLDPDU) are always included in LLDP advertisements.

In LLDP-MED advertisements the MAC/PHY Configuration/Status TLV will be always be included regardless of whether it is selected by this command.

The **no** variant of this command disables the specified optional TLVs, or all optional TLVs, for transmission in LLDP advertisements via the specified ports.

Syntax

```
lldp tlv-select {[<tlv>]...}
lldp tlv-select all
no lldp tlv-select {[<tlv>]...}
no lldp tlv-select all
```

Parameter	Description
<tlv>	<p>The TLV to transmit in LLDP advertisements. One of these keywords:</p> <ul style="list-style-type: none"> ■ port-description (specified by the description (interface) command on page 12.2) ■ system-name (specified by the hostname command on page 8.17) ■ system-description ■ system-capabilities ■ management-address ■ port-vlan ■ port-and-protocol-vlans ■ vlan-names ■ protocol-ids ■ mac-phy-config ■ power-management (Power Via MDI TLV) ■ link-aggregation ■ max-frame-size
all	all TLVs

Default By default no optional TLVs are included in LLDP advertisements. The MAC/PHY Configuration/Status TLV (**mac-phy-config**) is included in LLDP-MED advertisements whether or not it is selected by this command.

Mode Interface Configuration

Examples To include the management-address and system-name TLVs in advertisements transmitted via ports 1.0.1 and 1.0.7, use the commands:

```
awplus# configure terminal
awplus(config)# interface port1.0.1,port1.0.7
awplus(config-if)# lldp tlv-select management-address system-name
```

To include all optional TLVs in advertisements transmitted via ports 1.0.1 and 1.0.7, use the commands:

```
awplus# configure terminal
awplus(config)# interface port1.0.1,port1.0.7
awplus(config-if)# lldp tlv-select all
```

To exclude the management-address and system-name TLVs from advertisements transmitted via ports 1.0.1 and 1.0.7, use the commands:

```
awplus# configure terminal
awplus(config)# interface port1.0.1,port1.0.7
awplus(config-if)# no lldp tlv-select management-address system-name
```

To exclude all optional TLVs from advertisements transmitted via ports 1.0.1 and 1.0.7, use the commands:

```
awplus# configure terminal
awplus(config)# interface port1.0.1,port1.0.7
awplus(config-if)# no lldp tlv-select all
```

Related Commands [description \(interface\)](#)
[hostname](#)
[lldp med-tlv-select](#)
[show lldp interface](#)
[show lldp local-info](#)

lldp transmit receive

This command enables transmission and/or reception of LLDP advertisements to or from neighbors through the specified ports.

The **no** variant of this command disables transmission and/or reception of LLDP advertisements through specified ports.

Syntax `lldp {[transmit] [receive]}`
`no lldp {[transmit] [receive]}`

Parameter	Description
<code>transmit</code>	Enable or disable transmission of LLDP advertisements via this port or ports.
<code>receive</code>	Enable or disable reception of LLDP advertisements via this port or ports.

Default LLDP advertisement transmission and reception are enabled on all ports by default.

Mode Interface Configuration

Examples To enable transmission of LLDP advertisements on ports 1.0.1 and 1.0.7, use the commands:

```
awplus# configure terminal
awplus(config)# interface port1.0.1,port1.0.7
awplus(config-if)# lldp transmit
```

To enable LLDP advertisement transmission and reception on ports 1.0.1 and 1.0.7, use the commands:

```
awplus# configure terminal
awplus(config)# interface port1.0.1,port1.0.7
awplus(config-if)# lldp transmit receive
```

To disable LLDP advertisement transmission and reception on ports 1.0.1 and 1.0.7, use the commands:

```
awplus# configure terminal
awplus(config)# interface port1.0.1,port1.0.7
awplus(config-if)# no lldp transmit receive
```

Related Commands `show lldp interface`

lldp tx-delay

This command sets the value of the transmission delay timer. This is the minimum time interval between transmitting LLDP advertisements due to a change in LLDP local information.

The **no** variant of this command sets the transmission delay timer back to its default setting.

Syntax `lldp tx-delay <1-8192>`

`no lldp tx-delay`

Parameter	Description
<code><1-8192></code>	The transmission delay in seconds. The transmission delay cannot be greater than a quarter of the transmit interval (lldp timer command on page 81.16).

Default The default transmission delay timer is 2 seconds.

Mode Global Configuration

Examples To set the transmission delay timer to 12 seconds, use the commands:

```
awplus# configure terminal
awplus(config)# lldp tx-delay 12
```

To set the transmission delay timer back to its default value, use the commands:

```
awplus# configure terminal
awplus(config)# no lldp tx-delay
```

Related Commands [lldp timer](#)
[show lldp](#)

location civic-location configuration

Use these commands to configure a civic address location. The country parameter must be specified first, and at least one of the other parameters must be configured before the location can be assigned to a port.

Use the **no** variants of this command to delete civic address parameters from the location.

Syntax

```
country <country>
state <state>
no state
county <county>
no county
city <city>
no city
division <division>
no division
neighborhood <neighborhood>
no neighborhood
street-group <street-group>
no street-group
leading-street-direction <leading-street-direction>
no leading-street-direction
trailing-street-suffix <trailing-street-suffix>
no trailing-street-suffix
street-suffix <street-suffix>
no street-suffix
house-number <house-number>
no house-number
house-number-suffix <house-number-suffix>
no house-number-suffix
landmark <landmark>
no landmark
additional-information <additional-information>
no additional-information
name <name>
no name
postalcode <postalcode>
no postalcode
```

```

building <building>
no building
unit <unit>
no unit
floor <floor>
no floor
room <room>
no room
place-type <place-type>
no place-type
postal-community-name <postal-community-name>
no postal-community-name
post-office-box <post-office-box>
no post-office-box
additional-code <additional-code>
no additional-code
seat <seat>
no seat
primary-road-name <primary-road-name>
no primary-road-name
road-section <road-section>
no road-section
branch-road-name <branch-road-name>
no branch-road-name
sub-branch-road-name <sub-branch-road-name>
no sub-branch-road-name
street-name-pre-modifier <street-name-pre-modifier>
no street-name-pre-modifier
streetname-post-modifier <streetname-post-modifier>
no streetname-post-modifier

```

Parameter	Description
<country>	Upper-case two-letter country code, as specified in ISO 3166.
<state>	State (Civic Address (CA) Type 1): national subdivisions (state, canton, region).
<county>	County (CA Type 2): County, parish, gun (JP), district (IN).

Parameter (cont.)	Description (cont.)
<code><city></code>	City (CA Type 3): city, township, shi (JP).
<code><division></code>	City division (CA Type 4): City division, borough, city district, ward, chou (JP).
<code><neighborhood></code>	Neighborhood (CA Type 5): neighborhood, block.
<code><street-group></code>	Street group (CA Type 6): group of streets below the neighborhood level.
<code><leading-street-direction></code>	Leading street direction (CA Type 16).
<code><trailing-street-suffix></code>	Trailing street suffix (CA Type 17).
<code><street-suffix></code>	Street suffix (CA Type 18): street suffix or type.
<code><house-number></code>	House number (CA Type 19).
<code><house-number-suffix></code>	House number suffix (CA Type 20).
<code><landmark></code>	Landmark or vanity address (CA Type 21).
<code><additional-information></code>	Additional location information (CA Type 22).
<code><name></code>	Name (CA Type 23): residence and office occupant.
<code><postal-code></code>	Postal/zip code (CA Type 24).
<code><building></code>	Building (CA Type 25): structure.
<code><unit></code>	Unit (CA Type 26): apartment, suite.
<code><floor></code>	Floor (CA Type 27).
<code><room></code>	Room (CA Type 28).
<code><place-type></code>	Type of place (CA Type 29).
<code><postal-community-name></code>	Postal community name (CA Type 30).
<code><post-office-box></code>	Post office box (P.O. Box) (CA Type 31).
<code><additional-code></code>	Additional code (CA Type 32).
<code><seat></code>	Seat (CA Type 33): seat (desk, cubicle, workstation).
<code><primary-road-name></code>	Primary road name (CA Type 34).
<code><road-section></code>	Road section (CA Type 35).
<code><branch-road-name></code>	Branch road name (CA Type 36).
<code><sub-branch-road-name></code>	Sub-branch road name (CA Type 37).
<code><street-name-pre-modifier></code>	Street name pre-modifier (CA Type 38).
<code><street-name-post-modifier></code>	Street name post-modifier (CA Type 39).

Default By default no civic address location information is configured.

Mode Civic Address Location Configuration

Usage The **country** parameter must be configured before any other parameters can be configured; this creates the location. The country parameter cannot be deleted. One or more of the other parameters must be configured before the location can be assigned to a port. The country parameter must be entered as an upper-case two-letter country code, as specified in *ISO 3166*. All other parameters are entered as alpha-numeric strings. Do not configure all the civic address parameters (this would generate TLVs that are too long). Configure a subset of these parameters—enough to consistently and precisely identify the location of the device. If the location is to be used for Emergency Call Service (ECS), the particular ECS application may have guidelines for configuring the civic address location. For more information about civic address format, see “[LLDP-MED: Location Identification TLV](#)” on page 80.7.

To specify the civic address location, use the [location civic-location identifier command on page 81.25](#). To delete the civic address location, use the **no** variant of the [location civic-location identifier](#) command. To assign the civic address location to particular ports, so that it can be advertised in TLVs from those ports, use the command [location civic-location-id command on page 81.26](#).

Examples To configure civic address location 1 with location "27 Nazareth Avenue, Christchurch, New Zealand" in civic-address format, use the commands:

```
awplus# configure terminal
awplus(config)# location civic-location identifier 1
awplus(config-civic)# country NZ
awplus(config-civic)# city Christchurch
awplus(config-civic)# primary-road-name Nazareth
awplus(config-civic)# street-suffix Avenue
awplus(config-civic)# house-number 27
```

Related Commands [location civic-location-id](#)
[location civic-location identifier](#)
[show lldp local-info](#)
[show location](#)

location civic-location identifier

Use this command to enter the Civic Address Location Configuration mode to configure the specified location.

Use the **no** variant of this command to delete a civic address location. This also removes the location from any ports it has been assigned to.

Syntax `location civic-location identifier <civic-loc-id>`
`no location civic-location identifier <civic-loc-id>`

Parameter	Description
<code><civic-loc-id></code>	A unique civic address location ID, in the range 1 to 4095.

Default By default there are no civic address locations.

Mode Global Configuration

Usage To configure the location information for this civic address location identifier, use the [location civic-location configuration command on page 81.21](#). To associate this civic location identifier with particular ports, use the [location elin-location-id command on page 81.32](#).

Up to 400 locations can be configured on the switch for each type of location information, up to a total of 1200 locations.

Examples To enter Civic Address Location Configuration mode for the civic address location with ID 1, use the commands:

```
awplus# configure terminal
awplus(config)# location civic-location identifier 1
awplus(config-civic)#
```

To delete the civic address location with ID 1, use the commands:

```
awplus# configure terminal
awplus(config)# no location civic-location identifier 1
```

Related Commands [location civic-location-id](#)
[location civic-location configuration](#)
[show location](#)
[show running-config lldp](#)

location civic-location-id

Use this command to assign a civic address location to the ports. The civic address location must already exist. This replaces any previous assignment of civic address location for the ports. Up to one location of each type can be assigned to a port.

Use the **no** variant of this command to remove a location identifier from the ports.

Syntax `location civic-location-id <civic-loc-id>`
`no location civic-location-id [<civic-loc-id>]`

Parameter	Description
<code><civic-loc-id></code>	Civic address location ID, in the range 1 to 4095.

Default By default no civic address location is assigned to ports.

Mode Interface Configuration

Usage The civic address location associated with a port can be transmitted in Location Identification TLVs via the port.

Before using this command, create the location using the following commands:

- [location civic-location identifier command on page 81.25](#)
- [location civic-location configuration command on page 81.21](#)

If a civic-address location is deleted using the **no** variant of the [location civic-location identifier](#) command, it is automatically removed from all ports.

Examples To assign the civic address location 1 to port1.0.1, use the commands:

```
awplus# configure terminal
awplus(config)# interface port1.0.1
awplus(config-if)# location civic-location-id 1
```

To remove a civic address location from port1.0.1, use the commands:

```
awplus# configure terminal
awplus(config)# interface port1.0.1
awplus(config-if)# no location civic-location-id
```

Related Commands [lldp med-tlv-select](#)
[location civic-location identifier](#)
[location civic-location configuration](#)
[show location](#)

location coord-location configuration

Use this command to configure a coordinate-based location. All parameters must be configured before assigning this location identifier to a port.

Syntax

```
latitude <latitude>
lat-resolution <lat-resolution>
longitude <longitude>
long-resolution <long-resolution>
altitude <altitude> {meters|floor}
alt-resolution <alt-resolution>
datum {wgs84|nad83-navd|nad83-mlw}
```

Parameter	Description
<lat-resolution>	Latitude resolution, as a number of valid bits, in the range 0 to 34.
<latitude>	Latitude value in degrees in the range -90.0 to 90.0
<long-resolution>	Longitude resolution, as a number of valid bits, in the range 0 to 34.
<longitude>	Longitude value in degrees, in the range -180.0 to 180.0.
<alt-resolution>	Altitude resolution, as a number of valid bits, in the range 0 to 30. A resolution of 0 can be used to indicate an unknown value.
<altitude>	Altitude value, in meters or floors.
meters	The altitude value is in meters.
floors	The altitude value is in floors.
datum	The geodetic system (or datum) that the specified coordinate values are based on.
wgs84	World Geodetic System 1984.
nad83-navd	North American Datum 1983 - North American Vertical Datum.
nad83-mlw	North American Datum 1983 - Mean Lower Low Water vertical datum.

Default By default no coordinate location information is configured.

Mode Coordinate Configuration

Usage Latitude and longitude values are always stored internally, and advertised in the Location Identification TLV, as 34-bit fixed-point binary numbers, with a 25-bit fractional part, irrespective of the number of digits entered by the user. Likewise altitude is stored as a 30-bit fixed point binary number, with an 8-bit fractional part. Because the user-entered decimal values are stored as fixed point binary numbers, they cannot always be represented exactly—the stored binary number is converted to a decimal number for display in the output of the

[show location command on page 81.49](#). For example, a user-entered latitude value of "2.77" degrees is displayed as "2.7699999809265136718750000".

The **lat-resolution**, **long-resolution**, and **alt-resolution** parameters allow the user to specify the resolution of each coordinate element as the number of valid bits in the internally-stored binary representation of the value. These resolution values can be used by emergency services to define a search area.

To specify the coordinate identifier, use the [location coord-location identifier command on page 81.29](#). To remove coordinate information, delete the coordinate location by using the **no** variant of that command. To associate the coordinate location with particular ports, so that it can be advertised in TLVs from those ports, use the [location elin-location-id command on page 81.32](#).

Example To configure the location for the White House in Washington DC, which has the coordinates based on the WGS84 datum of 38.89868 degrees North (with 22 bit resolution), 77.03723 degrees West (with 22 bit resolution), and 15 meters height (with 9 bit resolution), use the commands:

```
awplus# configure terminal
awplus(config)# location coord-location identifier 1
awplus(config-coord)# la-resolution 22
awplus(config-coord)# latitude 38.89868
awplus(config-coord)# lo-resolution 22
awplus(config-coord)# longitude -77.03723
awplus(config-coord)# alt-resolution 9
awplus(config-coord)# altitude 15 meters
awplus(config-coord)# datum wgs84
```

Related Commands [location coord-location-id](#)
[location coord-location identifier](#)
[show lldp local-info](#)
[show location](#)

location coord-location identifier

Use this command to enter Coordinate Location Configuration mode for this coordinate location.

Use the **no** variant of this command to delete a coordinate location. This also removes the location from any ports it has been assigned to.

Syntax location coord-location identifier <coord-loc-id>
no location coord-location identifier <coord-loc-id>

Parameter	Description
<coord-loc-id>	A unique coordinate location identifier, in the range 1 to 4095.

Default By default there are no coordinate locations.

Mode Global Configuration

Usage Up to 400 locations can be configured on the switch for each type of location information, up to a total of 1200 locations.

To configure this coordinate location, use the [location coord-location configuration command on page 81.27](#). To associate this coordinate location with particular ports, so that it can be advertised in TLVs from those ports, use the [location coord-location-id command on page 81.30](#).

Examples To enter Coordinate Location Configuration mode to configure the coordinate location with ID 1, use the commands:

```
awplus# configure terminal
awplus(config)# location coord-location identifier 1
awplus(config-coord)#
```

To delete coordinate location 1, use the commands:

```
awplus# configure terminal
awplus(config)# no location coord-location identifier 1
```

Related Commands [location coord-location-id](#)
[location coord-location configuration](#)
[show lldp local-info](#)
[show location](#)

location coord-location-id

Use this command to assign a coordinate location to the ports. The coordinate location must already exist. This replaces any previous assignment of coordinate location for the ports. Up to one location of each type can be assigned to a port.

Use the **no** variant of this command to remove a location from the ports.

Syntax `location coord-location-id <coord-loc-id>`
`no location coord-location-id [<coord-loc-id>]`

Parameter	Description
<code><coord-loc-id></code>	Coordinate location ID, in the range 1 to 4095.

Default By default no coordinate location is assigned to ports.

Mode Interface Configuration

Usage The coordinate location associated with a port can be transmitted in Location Identification TLVs via the port.

Before using this command, configure the location using the following commands:

- [location coord-location identifier command on page 81.29](#)
- [location coord-location configuration command on page 81.27](#)

If a coordinate location is deleted using the **no** variant of the [location coord-location identifier](#) command, it is automatically removed from all ports.

Examples To assign coordinate location 1 to port1.0.1, use the commands:

```
awplus# configure terminal
awplus(config)# interface port1.0.1
awplus(config-if)# location coord-location-id 1
```

To remove a coordinate location from port1.0.1, use the commands:

```
awplus# configure terminal
awplus(config)# interface port1.0.1
awplus(config-if)# no location coord-location-id
```

Related Commands [lldp med-tlv-select](#)
[location coord-location identifier](#)
[location coord-location configuration](#)
[show location](#)

location elin-location

Use this command to create or modify an ELIN location.

Use the **no** variant of this command to delete an ELIN location, and remove it from any ports it has been assigned to.

Syntax `location elin-location <elin> identifier <elin-loc-id>`
`no location elin-location identifier <elin-loc-id>`

Parameter	Description
<code><elin></code>	Emergency Location Identification Number (ELIN) for Emergency Call Service (ECS), in the range 10 to 25 digits long. In North America, ELINs are typically 10 digits long.
<code><elin-loc-id></code>	A unique ELIN location identifier, in the range 1 to 4095.

Default By default there are no ELIN location identifiers.

Mode Global Configuration

Usage Up to 400 locations can be configured on the switch for each type of location information, up to a total of 1200 locations.

To assign this ELIN location to particular ports, so that it can be advertised in TLVs from those ports, use the [location elin-location-id command on page 81.32](#).

Examples To create a new ELIN location with ID 1, and configure it with ELIN "1234567890", use the commands:

```
awplus# configure terminal
awplus(config)# location elin-location 1234567890 identifier 1
```

To delete existing ELIN location with ID 1, use the commands:

```
awplus# configure terminal
awplus(config)# no location elin-location identifier 1
```

Related Commands [location elin-location-id](#)
[show lldp local-info](#)
[show location](#)

location elin-location-id

Use this command to assign an ELIN location to the ports. The ELIN location must already exist. This replaces any previous assignment of ELIN location for the ports. Up to one location of each type can be assigned to a port.

Use the **no** variant of this command to remove a location identifier from the ports.

Syntax `location elin-location-id <elin-loc-id>`
`no location elin-location-id [<elin-loc-id>]`

Parameter	Description
<code><elin-loc-id></code>	ELIN location identifier, in the range 1 to 4095.

Default By default no ELIN location is assigned to ports.

Mode Interface Configuration

Usage An ELIN location associated with a port can be transmitted in Location Identification TLVs via the port.

Before using this command, configure the location using the [location elin-location command on page 81.31](#).

If an ELIN location is deleted using the **no** variant of one of the [location elin-location](#) command, it is automatically removed from all ports.

Examples To assign ELIN location 1 to port1.0.1, use the commands:

```
awplus# configure terminal
awplus(config)# interface port1.0.1
awplus(config-if)# location elin-location-id 1
```

To remove an ELIN location from port1.0.1, use the commands:

```
awplus# configure terminal
awplus(config)# interface port1.0.1
awplus(config-if)# no location elin-location-id
```

Related Commands [lldp med-tlv-select](#)
[location elin-location](#)
[show location](#)

show debugging lldp

This command displays LLDP debug settings for specified ports. If no port list is supplied, LLDP debug settings for all ports are displayed.

Syntax `show debugging lldp [interface <port-list>]`

Parameter	Description
<port-list>	The ports for which the LLDP debug settings are shown.

Mode Privileged Exec

Examples To display LLDP debug settings for all ports, use the command:

```
awplus# show debugging lldp
```

To display LLDP debug settings for ports 1.0.1 to 1.0.9, use the command:

```
awplus# show debugging lldp interface port1.0.1-1.0.9
```

Output Figure 81-1: Example output from the **show debugging lldp** command

```
LLDP Debug settings:
Debugging for LLDP internal operation is on
Port      Rx      RxPkt   Tx      TxPkt
-----
1.0.1     Yes    Yes     No      No
1.0.2     Yes    No      No      No
1.0.3     No     No      No      No
1.0.4     Yes    Yes     Yes     No
1.0.5     Yes    No      Yes     No
1.0.6     No     No      Yes     No
1.0.7     Yes    Yes     Yes     Yes
1.0.8     Yes    No      Yes     Yes
1.0.9     No     No      Yes     Yes
```

Table 81-1: Parameters in the output of the **show debugging lldp** command

Parameter	Description
Port	Port name.
Rx	Whether debugging of LLDP receive is enabled on the port.
RxPkt	Whether debugging of LLDP receive packet dump is enabled on the port.
Rx	Whether debugging of LLDP transmit is enabled on the port.
RxPkt	Whether debugging of LLDP transmit packet dump is enabled on the port.

Related Commands `debug lldp`

show lldp

This command displays LLDP status and global configuration settings.

Syntax show lldp

Mode Privileged Exec

Example To display LLDP status and global configuration settings, use the command:

```
awplus# show lldp
```

Output

Figure 81-2: Example output from the **show lldp** command

```
awplus# show lldp

LLDP Global Configuration:                [Default Values]
LLDP Status ..... Enabled                [Disabled]
Notification Interval ..... 5 secs       [5]
Tx Timer Interval ..... 30 secs           [30]
Hold-time Multiplier ..... 4              [4]
(Computed TTL value ..... 120 secs)
Reinitialization Delay .... 2 secs        [2]
Tx Delay ..... 2 secs                     [2]
Fast Start Count ..... 5                  [3]

LLDP Global Status:
Total Neighbor Count ..... 47
Neighbors table last updated 0 hrs 0 mins 43 secs ago
```

Table 81-2: Parameters in the output of the **show lldp** command

Parameter	Description
LLDP Status	Whether LLDP is enabled. Default is disabled.
Notification Interval	Minimum interval between LLDP notifications.
Tx Timer Interval	Transmit interval between regular transmissions of LLDP advertisements.
Hold-time Multiplier	The holdtime multiplier. The transmit interval is multiplied by the holdtime multiplier to give the Time To Live (TTL) value that is advertised to neighbors.
Reinitialization Delay	The reinitialization delay. This is the minimum time after disabling LLDP transmit on a port before it can reinitialize again.
Tx Delay	The transmission delay. This is the minimum time interval between transmitting advertisements due to a change in LLDP local information.
Fast Start Count	The number of times fast start advertisements are sent for LLDP-MED.
Total Neighbor Count	Number of LLDP neighbors discovered on all ports.
Neighbors table last updated	The time since the LLDP neighbor table was last updated.

Related Commands `show lldp interface`
`show running-config lldp`

show lldp interface

This command displays LLDP configuration settings for specified ports. If no port list is specified, LLDP configuration for all ports is displayed.

Syntax `show lldp interface [<port-list>]`

Parameter	Description
<port-list>	The ports for which the LLDP configuration settings are to be shown

Mode Privileged Exec

Examples To display LLDP configuration settings for ports 1.0.1 to 1.0.8, use the command:

```
awplus# show lldp interface port1.0.1-1.0.8
```

To display LLDP configuration settings for all ports, use the command:

```
awplus# show lldp interface
```

Output

Figure 81-3: Example output from the `show lldp interface` command

```
awplus# show lldp interface port1.0.1-1.0.8
LLDP Port Status and Configuration:

* = LLDP is inactive on this port because it is a mirror analyser port
Notification Abbreviations:
  RC = LLDP Remote Tables Change          TC = LLDP-MED Topology Change
TLV Abbreviations:
  Base: Pd = Port Description              Sn = System Name
        Sd = System Description           Sc = System Capabilities
        Ma = Management Address
  802.1: Pv = Port VLAN ID                 Pp = Port And Protocol VLAN ID
        Vn = VLAN Name                    Pi = Protocol Identity
  802.3: Mp = MAC/PHY Config/Status        Po = Power Via MDI (PoE)
        La = Link Aggregation             Mf = Maximum Frame Size
  MED:  Mc = LLDP-MED Capabilities         Np = Network Policy
        Lo = Location Identification       Pe = Extended PoE      In = Inventory
```

Port	Rx/Tx	Notif	Management Addr	Optional TLVs Enabled for Tx			
				Base	802.1	802.3	MED
1.0.1	Rx Tx	RC --	192.168.100.123	PdSnSdScMa	-----	-----	McNpLoPe--
*1.0.2	-- Tx	RC --	192.168.100.123	PdSnSdScMa	-----	-----	McNpLoPe--
1.0.3	Rx Tx	RC --	192.168.100.123	Pd--SdScMa	PvPpVnPi	-----	McNpLoPe--
1.0.4	-- --	RC --	192.168.100.123	PdSnSd--Ma	-----	-----	McNpLoPe--
1.0.5	Rx Tx	RC TC	192.168.100.123	PdSnSdScMa	PvPpVnPi	-----	McNpLoPe--
1.0.6	Rx Tx	RC TC	192.168.100.123	Pd----ScMa	-----	-----	McNpLoPe--
1.0.7	Rx Tx	-- TC	192.168.100.123	PdSnSdScMa	PvPpVnPi	MpPoLaMf	McNpLoPeIn
1.0.8	Rx Tx	-- TC	192.168.1.1	PdSn--ScMa	PvPpVnPi	-----	McNp-----

Table 81-3: Parameters in the output of the **show lldp interface** command

Parameter	Description
Port	Port name.
Rx	Whether reception of LLDP advertisements is enabled on the port.
Tx	Whether transmission of LLDP advertisements is enabled on the port.
Notif	Whether sending SNMP notification for LLDP is enabled on the port. <ul style="list-style-type: none"> ■ RM = Remote Tables Change Notification ■ TP = LLDP-MED Topology Change Notification
Management Addr	Management address advertised to neighbors.
Base TLVs Enabled for Tx	List of optional Base TLVs enabled for transmission: <ul style="list-style-type: none"> ■ Pd = Port Description ■ Sn = System Name ■ Sd = System Description ■ Sc = System Capabilities ■ Ma = Management Address
802.1 TLVs Enabled for Tx	List of optional 802.1 TLVs enabled for transmission: <ul style="list-style-type: none"> ■ Pv = Port VLAN ID ■ Pp = Port And Protocol VLAN ID ■ Vn = VLAN Name ■ Pi = Protocol Identity
802.3 TLVs Enabled for Tx	List of optional 802.3 TLVs enabled for transmission: <ul style="list-style-type: none"> ■ Mp = MAC/PHY Configuration/Status ■ Po = Power Via MDI (PoE) ■ La = Link Aggregation ■ Mf = Maximum Frame Size
MED TLVs Enabled for Tx	List of optional LLDP-MED TLVs enabled for transmission: <ul style="list-style-type: none"> ■ Mc = LLDP-MED Capabilities ■ Np = Network Policy ■ Lo = Location Information, ■ Pe = Extended Power-Via-MDI ■ In = Inventory

Related Commands [show lldp](#)
[show running-config lldp](#)

show lldp local-info

This command displays local LLDP information that can be transmitted through specified ports. If no port list is entered, local LLDP information for all ports is displayed.

Syntax `show lldp local-info [base] [dot1] [dot3] [med] [interface <port-list>]`

Parameter	Description
base	Information for base TLVs.
dot1	Information for 802.1 TLVs.
dot3	Information for 802.3 TLVs.
med	Information for LLDP-MED TLVs.
<port-list>	The ports for which the local information is to be shown.

Mode Privileged Exec

Usage Whether and which local information is transmitted in advertisements via a port depends on:

- whether the port is set to transmit LLDP advertisements ([lldp transmit receive command on page 81.19](#))
- which TLVs it is configured to send ([lldp tlv-select command on page 81.17](#), [lldp med-tlv-select command on page 81.9](#)).

Examples To display local information transmitted via port 1.0.1, use the command:

```
awplus# show lldp local-info interface port1.0.1
```

To display local information transmitted via all ports, use the command:

```
awplus# show lldp local-info
```

Output

Figure 81-4: Example output from the `show lldp local-info` command

```

LLDP Local Information:

Local port1.0.1:
Chassis ID Type ..... MAC address
Chassis ID ..... 0015.77c9.7453
Port ID Type ..... Interface alias
Port ID ..... port1.0.1
TTL ..... 120
Port Description ..... [not configured]
System Name ..... awplus
System Description ..... Allied Telesis router/switch, AW+
v5.3.3
System Capabilities - Supported .. Bridge, Router
- Enabled .... Bridge, Router
Management Address ..... 192.168.1.6
Port VLAN ID (PVID) ..... 1
Port & Protocol VLAN - Supported . Yes
- Enabled ... No
- VIDs ..... 0
VLAN Names ..... default
Protocol IDs ..... 9000, 0026424203000000, 888e01, aaaa03,
88090101, 00540000e302, 0800, 0806, 86dd
MAC/PHY Auto-negotiation ..... Supported, Enabled
Advertised Capability ..... 1000BaseTFD, 100BaseTXFD, 100BaseTX,
10BaseTFD, 10BaseT
Operational MAU Type ..... 1000BaseTFD (30)
Power Via MDI (PoE) ..... Supported, Enabled
Port Class ..... PSE
Pair Control Ability ..... Disabled
Power Class ..... Unknown
Link Aggregation ..... Supported, Disabled
Maximum Frame Size ..... 1522
LLDP-MED Device Type ..... Network Connectivity
LLDP-MED Capabilities ..... LLDP-MED Capabilities, Network Policy,
Location Identification,
Extended Power - PSE, Inventory
Network Policy ..... [not configured]
Location Identification ..... Civic Address
Country Code ..... NZ
City ..... Christchurch
Street Suffix ..... Avenue
House Number ..... 27
Primary Road Name ..... Nazareth
Location Identification ..... ELIN
ELIN ..... 123456789012
Extended Power Via MDI (PoE) ..... PSE
Power Source ..... Primary Power
Power Priority ..... Low
Power Value ..... 4.4 Watts
Inventory Management:
Hardware Revision ..... A-0
Firmware Revision ..... 1.1.0
Software Revision ..... v5.3.3
Serial Number ..... G1Q78900B
Manufacturer Name ..... Allied Telesis Inc.
Model Name ..... x600-48Ts/XP
Asset ID ..... [zero length]

```

Table 81-4: Parameters in the output of the `show lldp local-info` command

Parameter	Description
Chassis ID Type	Type of the Chassis ID.
Chassis ID	Chassis ID that uniquely identifies the local device.
Port ID Type	Type of the Port ID.
Port ID	Port ID of the local port through which advertisements are sent.
TTL	Number of seconds that the information advertised by the local port remains valid.
Port Description	Port description of the local port, as specified by the description (interface) command on page 12.2 .
System Name	System name, as specified by the hostname command on page 8.17 .
System Description	System description.
System Capabilities (Supported)	Capabilities that the local port supports.
System Capabilities (Enabled)	Enabled capabilities on the local port.
Management Addresses	Management address associated with the local port. To change this, use the lldp management-address command on page 81.7 .
Port VLAN ID (PVID)	VLAN identifier associated with untagged or priority tagged frames received via the local port.
Port & Protocol VLAN (Supported)	Whether Port & Protocol VLANs (PPV) is supported on the local port.
Port & Protocol VLAN (Enabled)	Whether the port is in one or more Port & Protocol VLANs.
Port & Protocol VLAN (VIDs)	List of identifiers for Port & Protocol VLANs that the port is in.
VLAN Names	List of VLAN names for VLANs that the local port is assigned to.
Protocol IDs	List of protocols that are accessible through the local port.
MAC/PHY Auto-negotiation	Auto-negotiation support and current status of the 802.3 LAN on the local port.
Power Via MDI (PoE)	PoE-capability and current status on the local port.
Port Class	Whether the device is a PSE (Power Sourcing Entity) or a PD (Powered Device)
Pair Control Ability	Whether power pair selection can be controlled
Power Pairs	Which power pairs are selected for power ("Signal Pairs" or "Spare Pairs") if pair selection can be controlled

Table 81-4: Parameters in the output of the **show lldp local-info** command (cont.)

Parameter	Description
Power Class	The power class of the PD device on the port (class 0, 1, 2, 3 or 4)
Link Aggregation	Whether the link is capable of being aggregated and it is currently in an aggregation.
Aggregated Port-ID	Aggregated port identifier.
Maximum Frame Size	The maximum frame size capability of the implemented MAC and PHY.
LLDP-MED Device Type	LLDP-MED device type
LLDP-MED Capabilities	Capabilities LLDP-MED capabilities supported on the local port.
Network Policy	List of network policies configured on the local port.
VLAN ID	VLAN identifier for the port for the specified application type
Tagged Flag	Whether the VLAN ID is to be used as tagged or untagged
Layer-2 Priority:	Layer-2 User Priority (in the range 0 to 7)
DSCP Value	Diffserv codepoint (in the range 0 to 63)
Location Identification	Location configured on the local port.
Extended Power Via MDI (PoE)	PoE-capability and current status of the PoE parameters for Extended Power-Via-MDI TLV on the local port.
Power Source	The power source the switch currently uses; either primary power or backup power.
Power Priority	The power priority configured on the port; either critical, high or low.
Power Value	The total power the switch can source over a maximum length cable to a PD device on the port. The value shows the power value in Watts from the PD side.
Inventory Management	Inventory information for the device.

Related Commands [description \(interface\)](#)
[hostname](#)
[lldp transmit receive](#)

show lldp neighbors

This command displays a summary of information received from neighbors via specified ports. If no port list is supplied, neighbor information for all ports is displayed.

Syntax `show lldp neighbors [interface <port-list>]`

Parameter	Description
<port-list>	The ports for which the neighbor information is to be shown

Mode Privileged Exec

Examples To display neighbor information received via all ports, use the command:

```
awplus# show lldp neighbors
```

To display neighbor information received via ports 1.0.1 and 1.0.7 with LLDP-MED configuration, use the command:

```
awplus# show lldp neighbors interface port1.0.1,port1.0.7
```

Output

Figure 81-5: Example output from the `show lldp neighbors` command

```

LLDP Neighbor Information:
Total number of neighbors on these ports .... 4

System Capability Codes:
  O = Other   P = Repeater   B = Bridge           W = WLAN Access Point
  R = Router  T = Telephone   C = DOCSIS Cable Device   S = Station Only
LLDP-MED Device Type and Power Source Codes:
  1 = Class I   3 = Class III   PSE = PoE   Both = PoE&Local   Prim = Primary
  2 = Class II  N = Network Con.  Loc1 = Local  Unkn = Unknown   Back = Backup

Local   Neighbor      Neighbor      Neighbor      System      MED
Port   Chassis ID    Port ID       Sys Name      Cap.        Ty Pwr
-----
1.0.1   002d.3044.7ba6  port1.0.2     awplus        OPBWR TCS
1.0.1   0011.3109.e5c6  port1.0.3     AT-9924 switch/route... --B-R---
1.0.7   0000.10cf.8590  port3         AR-442S       --B-R---
1.0.7   00ee.4352.df51  192.168.1.2   Jim's desk phone --B--T--      3 PSE
    
```

Table 81-5: Parameters in the output of the `show lldp neighbors` command

Parameter	Description
Local Port	Local port on which the neighbor information was received.
Neighbor Chassis ID	Chassis ID that uniquely identifies the neighbor.
Neighbor Port Name	Port ID of the neighbor.
Neighbor Sys Name	System name of the LLDP neighbor.

Table 81-5: Parameters in the output of the **show lldp neighbors** command (cont.)

Parameter	Description
Neighbor Capability	Capabilities that are supported and enabled on the neighbor.
System Capability	System Capabilities of the LLDP neighbor.
MED Device Type	LLDP-MED Device class (Class I, II, III or Network Connectivity)
MED Power Source	LLDP-MED Power Source

Related Commands [show lldp neighbors detail](#)

show lldp neighbors detail

This command displays in detail the information received from neighbors via specified ports. If no port list is supplied, detailed neighbor information for all ports is displayed.

Syntax `show lldp neighbors detail [base] [dot1] [dot3] [med] [interface <port-list>]`

Parameter	Description
base	Information for base TLVs.
dot1	Information for 802.1 TLVs.
dot3	Information for 803.1 TLVs.
med	Information for LLDP-MED TLVs.
<port-list>	The ports for which the neighbor information is to be shown.

Mode Privileged Exec

Examples To display detailed neighbor information received via all ports, use the command:

```
awplus# show lldp neighbors detail
```

To display detailed neighbor information received via ports 1.0.1, use the command:

```
awplus# show lldp neighbors detail interface port1.0.1
```

Output

Figure 81-6: Example output from the `show lldp neighbors detail` command

```
awplus# show lldp neighbors detail interface port1.0.1
LLDP Detailed Neighbor Information:

Local port1.0.1:
  Neighbors table last updated 0 hrs 0 mins 40 secs ago

Chassis ID Type ..... MAC address
Chassis ID ..... 0004.cd28.8754
Port ID Type ..... Interface alias
Port ID ..... port1.0.8
TTL ..... 120 (secs)
Port Description ..... [zero length]
System Name ..... awplus
System Description ..... Allied Telesis router/switch, AW+ v5.3.3
System Capabilities - Supported .. Bridge, Router
                  - Enabled .... Bridge, Router
Management Addresses ..... 0004.cd28.8754
Port VLAN ID (PVID) ..... 1
Port & Protocol VLAN - Supported . Yes
                  - Enabled ... Yes
                  - VIDs ..... 5
VLAN Names ..... default, vlan5
Protocol IDs ..... 9000, 0026424203000000, 888e01, 8100,
                  88090101, 00540000e302, 0800, 0806, 86dd
MAC/PHY Auto-negotiation ..... Supported, Enabled
  Advertised Capability ..... 1000BaseTFD, 100BaseTXFD, 100BaseTX,
                              10BaseTFD, 10BaseT
  Operational MAU Type ..... 1000BaseTFD (30)
Power Via MDI (PoE) ..... [not advertised]
Link Aggregation ..... Supported, Disabled
Maximum Frame Size ..... 1522 (Octets)
LLDP-MED Device Type ..... Network Connectivity
LLDP-MED Capabilities ..... LLDP-MED Capabilities, Network Policy,
                              Location Identification,
                              Extended Power - PSE, Inventory
Network Policy ..... [not advertised]
Location Identification ..... [not advertised]
Extended Power Via MDI (PoE) ..... PD
  Power Source ..... PSE
  Power Priority ..... High
  Power Value ..... 4.4 Watts
Inventory Management:
  Hardware Revision ..... X1-0
  Firmware Revision ..... 1.1.0
  Software Revision ..... 5.3.3
  Serial Number ..... M1NB73008
  Manufacturer Name ..... Allied Telesis Inc.
  Model Name ..... x900-12XT/S
  Asset ID ..... [zero length]
```

Table 81-6: Parameters in the output of the `show lldp neighbors detail` command

Parameter	Description
Chassis ID Type	Type of the Chassis ID.
Chassis ID	Chassis ID that uniquely identifies the neighbor.
Port ID Type	Type of the Port ID.
Port ID	Port ID of the neighbor.
TTL	Number of seconds that the information advertised by the neighbor remains valid.
Port Description	Port description of the neighbor's port.
System Name	Neighbor's system name.

Table 81-6: Parameters in the output of the `show lldp neighbors detail` command (cont.)

Parameter	Description
System Description	Neighbor's system description.
System Capabilities (Supported)	Capabilities that the neighbor supports.
System Capabilities (Enabled)	Capabilities that are enabled on the neighbor.
Management Addresses	List of neighbor's management addresses.
Port VLAN ID (PVID)	VLAN identifier associated with untagged or priority tagged frames for the neighbor port.
Port & Protocol VLAN (Supported)	Whether Port & Protocol VLAN is supported on the LLDP neighbor.
Port & Protocol VLAN (Enabled)	Whether Port & Protocol VLAN is enabled on the LLDP neighbor.
Port & Protocol VLAN (VIDs)	List of Port & Protocol VLAN identifiers.
VLAN Names	List of names of VLANs that the neighbor's port belongs to.
Protocol IDs	List of protocols that are accessible through the neighbor's port.
MAC/PHY Auto-negotiation	Auto-negotiation configuration and status
Power Via MDI (PoE)	PoE configuration and status of 802.3 Power-Via-MDI TLV
Link Aggregation	Link aggregation information
Maximum Frame Size	The maximum frame size capability
LLDP-MED Device Type	LLDP-MED Device type
LLDP-MED Capabilities	LLDP-MED capabilities supported
Network Policy	List of network policies
Location Identification	Location information
Extended Power Via MDI (PoE)	PoE-capability and current status
Inventory Management	Inventory information

Related Commands [show lldp neighbors](#)

show lldp statistics

This command displays the global LLDP statistics (packet and event counters).

Syntax `show lldp statistics`

Mode Privileged Exec

Example To display global LLDP statistics information, use the command:

```
awplus# show lldp statistics
```

Output

Figure 81-7: Example output from the `show lldp statistics` command

```
awplus# show lldp statistics
Global LLDP Packet and Event counters:
  Frames:   Out ..... 345
            In ..... 423
            In Errored ..... 0
            In Dropped ..... 0
  TLVs:    Unrecognized ..... 0
            Discarded ..... 0
  Neighbors: New Entries ..... 20
             Deleted Entries ..... 20
             Dropped Entries ..... 0
             Entry Age-outs ..... 20
```

Table 81-7: Parameters in the output of the `show lldp statistics` command

Parameter	Description
Frames Out	Number of LLDPDU frames transmitted.
Frames In	Number of LLDPDU frames received.
Frames In Errored	Number of invalid LLDPDU frames received.
Frames In Dropped	Number of LLDPDU frames received and discarded for any reason.
TLVs Unrecognized	Number of LLDP TLVs received that are not recognized but the TLV type is in the range of reserved TLV types.
TLVs Discarded	Number of LLDP TLVs discarded for any reason.
Neighbors New Entries	Number of times the information advertised by neighbors has been inserted into the neighbor table.
Neighbors Deleted Entries	Number of times the information advertised by neighbors has been removed from the neighbor table.
Neighbors Dropped Entries	Number of times the information advertised by neighbors could not be entered into the neighbor table because of insufficient resources.
Neighbors Entry Age-outs Entries	Number of times the information advertised by neighbors has been removed from the neighbor table because the information TTL interval has expired.

Related Commands `clear lldp statistics`
`show lldp statistics interface`

show lldp statistics interface

This command displays the LLDP statistics (packet and event counters) for specified ports. If no port list is supplied, LLDP statistics for all ports are displayed.

Syntax `show lldp statistics interface [<port-list>]`

Parameter	Description
<code><port-list></code>	The ports for which the statistics are to be shown.

Mode Privileged Exec

Examples To display LLDP statistics information for all ports, use the command:

```
awplus# show lldp statistics interface
```

To display LLDP statistics information for ports 1.0.1 and 1.0.7, use the command:

```
awplus# show lldp statistics interface port1.0.1,port1.0.7
```

Output Figure 81-8: Example output from the `show lldp statistics interface` command

```
awplus# show lldp statistics interface port1.0.1,port1.0.7

LLDP Packet and Event Counters:

port1.0.1
  Frames:    Out ..... 27
             In ..... 22
             In Errored ..... 0
             In Dropped ..... 0
  TLVs:     Unrecognized ..... 0
             Discarded ..... 0
  Neighbors: New Entries ..... 3
             Deleted Entries ..... 0
             Dropped Entries ..... 0
             Entry Age-outs ..... 0

port1.0.17
  Frames:    Out ..... 15
             In ..... 18
             In Errored ..... 0
             In Dropped ..... 0
  TLVs:     Unrecognized ..... 0
             Discarded ..... 0
  Neighbors: New Entries ..... 1
             Deleted Entries ..... 0
             Dropped Entries ..... 0
             Entry Age-outs ..... 0
```

Table 81-8: Parameters in the output of the `show lldp statistics interface` command

Parameter	Description
Frames Out	Number of LLDPDU frames transmitted.
Frames In	Number of LLDPDU frames received.
Frames In Errored	Number of invalid LLDPDU frames received.
Frames In Dropped	Number of LLDPDU frames received and discarded for any reason.
TLVs Unrecognized	Number of LLDP TLVs received that are not recognized but the TLV type is in the range of reserved TLV types.
TLVs Discarded	Number of LLDP TLVs discarded for any reason.
Neighbors New Entries	Number of times the information advertised by neighbors has been inserted into the neighbor table.
Neighbors Deleted Entries	Number of times the information advertised by neighbors has been removed from the neighbor table.
Neighbors Dropped Entries	Number of times the information advertised by neighbors could not be entered into the neighbor table because of insufficient resources.
Neighbors Entry Age-outs Entries	Number of times the information advertised by neighbors has been removed from the neighbor table because the information TTL interval has expired.

Related Commands `clear lldp statistics`
 `show lldp statistics`

show location

Use this command to display selected location information configured on the switch.

Syntax

```
show location {civic-location|coord-location|elin-location}
show location {civic-location|coord-location|elin-location}
  identifier {<civic-loc-id>|<coord-loc-id>|<elin-loc-id>}
show location {civic-location|coord-location|elin-location} interface
  <port-list>
```

Parameter	Description
civic-location	Display civic location information.
coord-location	Display coordinate location information.
elin-location	Display ELIN location information.
<civic-loc-id>	Civic address location identifier, in the range 1 to 4095.
<coord-loc-id>	Coordinate location identifier, in the range 1 to 4095.
<elin-loc-id>	ELIN location identifier, in the range 1 to 4095.
<port-list>	Ports to display information about.

Mode Privileged Exec

Examples To display a civic address location configured on port1.0.1, use the command:

```
awplus# show location civic-location interface port1.0.1
```

Figure 81-9: Example output from the **show location** command

```
awplus# show location civic-location interface port1.0.1
Port      ID  Element Type          Element Value
-----
1.0.1    1   Country              NZ
          City                 Christchurch
          Street-suffix        Avenue
          House-number         27
          Primary-road-name   Nazareth
```

To display coordinate location information configured on the identifier 1, use the command:

```
awplus# show location coord-location identifier 1
```

Figure 81-10: Example output from the `show location` command

```
awplus# show location coord-location identifier 1
  ID  Element Type                Element Value
-----
  1   Latitude Resolution         15 bits
      Latitude                   38.8986481130123138427734375 degrees
      Longitude Resolution       15 bits
      Longitude                   130.2323232293128967285156250 degrees
      Altitude Resolution        10 bits
      Altitude                   2.50000000 meters
      Map Datum                  WGS 84
```

The coordinate location information displayed may differ from the information entered because it is stored in binary format. For more information, see the [location coord-location configuration command on page 81.27](#).

To display all ELIN location information configured on the switch, use the command:

```
awplus# show location elin-location
```

Figure 81-11: Example output from the `show location` command

```
awplus# show location elin-location
  ID  ELIN
-----
  1   1234567890
  2   5432154321
```

Related Commands

- [location elin-location-id](#)
- [location civic-location identifier](#)
- [location civic-location configuration](#)
- [location coord-location identifier](#)
- [location coord-location configuration](#)
- [location elin-location](#)

Chapter 82: SMTP Commands



Command List	82.2
debug mail.....	82.2
delete mail.....	82.3
mail.....	82.4
mail from.....	82.5
mail smtpserver.....	82.5
show counter mail.....	82.6
show mail.....	82.6
undebg mail.....	82.7

Command List

This chapter provides an alphabetical reference for commands used to configure SMTP.

For information about modifying or redirecting the output from **show** commands to a file, see [“Controlling “show” Command Output” on page 1.35.](#)

debug mail

This command turns on debugging for sending emails.

The **no** variant of this command turns off debugging for sending emails.

Syntax debug mail
no debug mail

Mode Privileged Exec

Examples To turn on debugging for sending emails, use the command:

```
awplus# debug mail
```

To turn off debugging for sending emails, use the command:

```
awplus# no debug mail
```

Related Commands delete mail
mail
mail from
mail smtpserver
show mail
show counter mail
undebug mail

delete mail

This command deletes mail from the queue.

Syntax `delete mail [mail-id <mail-id>|all]`

Parameter	Description
mail-id	Deletes a single mail from the mail queue. <mail-id> An unique mail ID number. Use the show mail command to display this for an item of mail.
all	Delete all the mail in the queue.

Mode Privileged Exec

Examples To delete a unique mail item 20060912142356.1234 from the queue, use the command:

```
awplus# delete mail 20060912142356.1234
```

To delete all mail from the queue, use the command:

```
awplus# delete mail all
```

Related Commands [debug mail](#)
[mail](#)
[mail from](#)
[mail smtpserver](#)
[show mail](#)

mail

This command sends an email using the SMTP protocol. If you specify a file the text inside the file is sent in the message body.

If you do not specify the **to**, **file**, or **subject** parameters, the CLI prompts you for the missing information.

Before you can send mail using this command, you must specify the sending email address using the **mail from** command and a mail server using the **mail smtpserver** command.

Syntax `mail [{to <to>|subject <subject>|file <filename>}]`

Parameter	Description
to	The email recipient.
	<to> Email address.
subject	Description of the subject of this email. Use quote marks when the subject text contains spaces.
	<subject> String.
file	File to insert as text into the message body.
	<filename> String.

Mode Privileged Exec

Example To send an email to `rei@nerv.com` with the subject `dummy plug configuration`, and with the message body inserted from the file `plug.conf` use the command:

```
awplus# mail rei@nerv.com subject dummy plug configuration
filename plug.conf
```

Related Commands `debug mail`
 `delete mail`
 `mail from`
 `mail smtpserver`
 `show mail`
 `show counter mail`

mail from

This command sets an email address for the 'mail from' SMTP command. You must specify a sending email address with this command before you can send any email.

Syntax `mail from <from>`

Parameter	Description
<code><from></code>	The email address that the mail is sent from.

Mode Global Configuration

Example To set the email address you are sending mail from to `kaji@nerv.com`, use the command:

```
awplus#configure terminal
awplus(config)#mail from kaji@nerv.com
```

Related Commands `delete mail`
`mail`
`mail smtpserver`
`show mail`

mail smtpserver

This command sets the IP address of the SMTP server that your device sends email to. You must specify a mail server with this command before you can send any email.

Syntax `mail smtpserver <ip-address>`

Parameter	Description
<code><ip-address></code>	Internet Protocol (IP) Address for the mail server specified.

Mode Global Configuration

Example To specify a mail server at `192.168.0.1`, use the command:

```
awplus#mail smtpserver 192.168.0.1
```

Related Commands `debug mail`
`delete mail`
`mail`
`mail from`
`show mail`
`show counter mail`

show counter mail

This command displays the mail counters.

Syntax `show counter mail`

Mode User Exec and Privileged Exec

Output Figure 82-1: Example output from the **show counter mail** command

```
Mail Client (SMTP) counters
Mails Sent           ..... 0
Mails Sent Fails     ..... 1
```

Table 82-1: Parameters in the output of the **show counter mail** command

Parameter	Description
Mails Sent	The number of emails sent successfully since the last device restart.
Mails Sent Fails	The number of emails the device failed to send since the last device restart.

Example To show the emails in the queue use the command:

```
awplus# show counter mail
```

Related Commands `debug mail`
`delete mail`
`mail`
`mail from`
`show mail`

show mail

This command displays the emails in the queue.

Syntax `show mail`

Mode Privileged Exec

Example To display the emails in the queue use the command:

```
awplus# show mail
```

Related Commands `delete mail`
`mail`
`show counter mail`

undebbug mail

This command applies the functionality of the [no debug mail command on page 82.2](#).

Chapter 83: RMON Introduction



Introduction.....	83.2
Overview.....	83.2
RMON Configuration Example.....	83.3

Introduction

The chapter describes the Remote Network MONitoring (RMON) service on the switch, and describes a configuration example showing how to set up an RMON alarm.

This RMON alarm configuration example described creates SNMP traps and log messages when the rate of receipt of Broadcast packets on a switch port exceeds a threshold, and creates SNMP traps and log messages when the rate of receipt of Broadcast packets on a switch drops below a lower threshold.

For detailed information about the commands used to configure RMON, see [Chapter 84, RMON Commands](#)

RMON is disabled by default in AlliedWare Plus™. No RMON alarms or events are configured.

Overview

The Remote Network MONitoring (RMON) MIB (RFC2819) was developed by the IETF to support monitoring and protocol analysis of LANs with a focus on Layer 1 and 2 information in networks. RMON is an industry standard that provides the functionality in network analyzers.

An RMON implementation operates in a client/server model. Monitoring devices (or 'probes') contain RMON agents that collect information and analyze packets. The probes are servers and the Network Management applications that communicate with them are clients. While agent configuration and data collection uses SNMP, RMON operates differently than SNMP systems:

- Probes have responsibility for data collection and processing, reducing SNMP traffic and reducing processing load for clients.
- Information is only transmitted to the management application when required, not polled.

RMON is mainly used for 'flow-based' monitoring, while SNMP is mainly used for 'device-based' management. RMON data collected deals mainly with traffic patterns on the network, and SNMP data collected usually deals with the status of individual devices on the network.

One disadvantage of flow based monitoring is that remote devices have much more of the management burden, and require more resources. AlliedWare Plus minimizes the management and resources burden by implementing a subset of the RMON MIB group to provide a minimal RMON agent implementation supporting statistics, history, alarms, and events.

The RMON groups supported in AlliedWare Plus™ are:

- **Statistics** - collects ethernet statistics on a switch port, such as utilization and collisions.
- **History** - collects a history of ethernet statistics on a switch port.
- **Alarms** - monitor a MIB object for a specified interval, trigger an alarm at a specified value (the '**rising threshold**'), and resets the alarm at another value (the '**falling threshold**'). Alarms are used with events to trigger alarms, which generate logs or SNMP traps.
- **Events** - specify the action to take when an event is triggered by an alarm. The action of an event can generate a log or an SNMP trap.

RMON Configuration Example

This configuration example sets up an RMON alarm to create SNMP traps and log messages. This RMON alarm creates SNMP traps and log messages when the rate of receipt of Broadcast packets on a switch port exceeds a threshold, and creates SNMP traps and log messages when the rate of receipt of Broadcast packets on a switch port drops below a lower threshold.

Step 1: Set up an RMON collection on the switch port that is being monitored.

Use the following commands to configure this functionality:

```
awplus# configure terminal
awplus(config)# interface port1.0.4
awplus(config-if)# rmon collection stats 4
```

This will cause the software to build a table in which it stores statistics relating to the switch port.

Step 2: Define an RMON event that will be called by the Alarm when the thresholds are passed.

Create this as a 'trap and log' event, so that both an SNMP trap and a log message will be generated. The trap will be sent to the SNMP community named 'public'.

Use the following command to configure this functionality:

```
awplus(config-if)# rmon event 10 log trap public
```

Step 3: Create the RMON alarm.

Every 5 seconds, the alarm checks the broadcast packet counter in RMON collection stats 4. If the change in the value of that counter over the 5 second interval exceeds 5000 (1000 broadcasts per second), the alarm will trigger the event defined in step 2 above.

Additionally, when the rate broadcast falls below 500 broadcasts per 5 seconds, then the alarm will trigger the event defined in step 2 above again.

Use the below command to configure this functionality:

```
awplus(config-if)# rmon alarm 5 etherStatsBroadcastPkts.4
                    interval 5 delta rising-threshold 5000
                    event 10 falling-threshold 500 event 10
```

For the variable 'etherStatsBroadcastPkts.4' in this command, note that '.4' refers to the index number of the RMON collection stats 4 as defined on port1.0.4. So, 'etherStatsBroadcastPkts.4' refers to 'Received broadcasts' in RMON collection stats 4. Further counters for RMON are defined in section 5 of RFC 1757.

Step 4: Enable RMON traps.

To ensure that the SNMP trap is sent, you need to enable RMON traps, and you need to define a trap host in SNMP. Use the below commands to configure this functionality:

```
awplus# configure terminal
awplus(config)# snmp-server
awplus(config)# snmp-server enable trap rmon
awplus(config)# snmp-server community public
awplus(config)# snmp-server host 192.168.2.254 version 2c
public
```

Note that the resulting log message will be of the form listed below:

```
RMON [1024]: Alarm Index 5 alarm Rising Threshold 5000 alarm
Value 5117 alarm Rising event Index 10 event description
RMON_SNMP
```

Chapter 84: RMON Commands



Command List	84.2
rmon alarm	84.3
rmon collection history	84.5
rmon collection stats	84.6
rmon event	84.7
show rmon alarm	84.8
show rmon event	84.9
show rmon history	84.10
show rmon statistics	84.12

Command List

This chapter provides an alphabetical reference for commands used to configure Remote Monitoring (RMON).

For an introduction to RMON and an RMON configuration example, see [Chapter 83, RMON Introduction](#)

RMON is disabled by default in AlliedWare Plus™. No RMON alarms or events are configured.

For information about modifying or redirecting the output from **show** commands to a file, see [“Controlling “show” Command Output” on page 1.35](#).

rmon alarm

Use this command to configure an RMON alarm to monitor the value of an SNMP object, and to trigger specified events when the monitored object crosses specified thresholds.

To specify the action taken when the alarm is triggered, use the event index of an event defined by the [rmon event](#) command.

Use the **no** variant of this command to remove the alarm configuration.

Note Only alarms for switch port interfaces, not for VLAN interfaces, can be configured.



Syntax

```
rmon alarm <alarm-index> <oid> interval <1-65535> {delta|absolute}
  rising-threshold <1-65535> event <rising-event-index>
  falling-threshold <1-65535> event <falling-event-index>
  [owner <owner>]
```

```
no rmon alarm <alarm-index>
```

Parameter	Description
<alarm-index>	<1-65535> Alarm entry index value.
<oid>	The variable SNMP MIB Object Identifier (OID) name to be monitored, in the format etherStatsEntry.field.<stats-index>. For example, etherStatsEntry.5.22 is the OID for the etherStatsPkts field in the etherStatsEntry table for the interface defined by the <stats-index> 22 in the rmon collection stats command.
interval <1-65535>	Polling interval in seconds.
delta	The RMON MIB alarmSampleType: the change in the monitored MIB object value between the beginning and end of the polling interval.
absolute	The RMON MIB alarmSampleType: the value of the monitored MIB object.
rising-threshold <1-65535>	Rising threshold value of the alarm entry.
<rising-event-index>	<1-65535> The event to be triggered when the monitored object value reaches the rising threshold value. This is an event index of an event specified by the rmon event command.
falling-threshold <1-65535>	Falling threshold value of the alarm entry.
<falling-event-index>	<1-65535> The event to be triggered when the monitored object value reaches the falling threshold value. This is an event index of an event specified by the rmon event command.
owner <owner>	Arbitrary owner name to identify the alarm entry.

Default By default, there are no alarms.

Mode Global Configuration

Usage Note that the SNMP MIB Object Identifier (OID) indicated in the command syntax with *<oid>* must be specified as a dotted decimal value with the form `etherStatsEntry.field.<stats-index>`.

Example To configure an alarm to monitor the change per minute in the etherStatsPkt value for interface 22 (defined by stats-index 22 in the `rmon collection stats` command), to trigger event 2 (defined by the `rmon event` command) when it reaches the rising threshold 400, and to trigger event 3 when it reaches the falling threshold 200, and identify this alarm as belonging to Maria, use the commands:

```
awplus# configure terminal
awplus(config)# rmon alarm 229 etherStatsEntry.22.5 interval 60
                  delta rising-threshold 400 event 2 falling-
                  threshold 200 event 3 owner maria
```

Related Commands `rmon collection stats`
`rmon event`

rmon collection history

Use this command to create a history statistics control group to store a specified number of snapshots (buckets) of the standard RMON statistics for the switch port, and to collect these statistics at specified intervals. If there is sufficient memory available, then the device will allocate memory for storing the set of buckets that comprise this history control.

Use the **no** variant of this command to remove the specified history control configuration.

Note Only a history for switch port interfaces, not for VLAN interfaces, can be collected.



Syntax `rmon collection history <history-index> [buckets <1-65535>]
[interval <1-3600>] [owner <owner>]`
`no rmon collection history <history-index>`

Parameter	Description
<code><history-index></code>	<code><1-65535></code> A unique RMON history control entry index value.
<code>buckets <1-65535></code>	Number of requested buckets to store snapshots. Default 50 buckets.
<code>interval <1-3600></code>	Polling interval in seconds. Default 1800 second polling interval.
<code>owner <owner></code>	Owner name to identify the entry.

Default The default interval is 1800 seconds and the default buckets is 50 buckets.

Mode Interface Configuration

Example

```
awplus# configure terminal
awplus(config)# interface port1.0.2
awplus(config-if)# rmon collection history 200 buckets 500
                    interval 600 owner herbert

awplus# configure terminal
awplus(config)# interface port1.0.2
awplus(config-if)# no rmon collection history 200
```

rmon collection stats

Use this command to enable the collection of RMON statistics on a switch port, and assign an index number by which to access these collected statistics.

Use the **no** variant of this command to stop collecting RMON statistics on this switch port.

Note Only statistics for switch port interfaces, not for VLAN interfaces, can be collected.



Syntax `rmon collection stats <collection-index> [owner <owner>]`
`no rmon collection stats <collection-index>`

Parameter	Description
<code><collection-index></code>	<code><1-65535></code> Give this collection of statistics an index number to uniquely identify it. This is the index to use to access the statistics collected for this switch port.
<code>owner <owner></code>	An arbitrary owner name to identify this statistics collection entry.

Default The ethernet statistics probe is not running by default.

Mode Interface Configuration

Example

```
awplus# configure terminal
awplus(config)# interface port1.1.3
awplus(config-if)# rmon collection stats 200 owner myrtle

awplus# configure terminal
awplus(config)# interface port1.1.3
awplus(config-if)# no rmon collection stats 200
```

rmon event

Use this command to create an event definition for a log or a trap or both. The event index for this event can then be referred to by the [rmon alarm](#) command.

Use the **no** variant of this command to remove the event definition.

Note  Only the events for switch port interfaces, not for VLAN interfaces, can be collected.

Syntax

```
rmon event <event-index> [description <description>|owner <owner>|
  trap <trap>]

rmon event <event-index> [log [description <description>|
  owner <owner>|trap <trap>] ]

rmon event <event-index> [log trap [description <description>|
  owner <owner>] ]

no rmon event <event-index>
```

Parameter	Description
<event-index>	<1-65535> Unique event entry index value.
log	Log event type.
trap	Trap event type.
log trap	Log and trap event type.
description <description>	Event entry description.
owner <owner>	Owner name to identify the entry.

Default No event is configured by default.

Mode Global Configuration

Example

```
awplus# configure terminal
awplus(config)# rmon event 299 log description cond3 owner alfred

awplus# configure terminal
awplus(config)# no rmon event 299
```

Related Commands [rmon alarm](#)

show rmon alarm

Use this command to display the alarms and threshold configured for the RMON probe.

Note Only the alarms for switch port interfaces, not for VLAN interfaces, can be shown.



Syntax `show rmon alarm`

Mode User Exec and Privileged Exec

Example

```
awplus# show rmon alarm
```

Related Commands [rmon alarm](#)

show rmon event

Use this command to display the events configured for the RMON probe.

Note Only the events for switch port interfaces, not for VLAN interfaces, can be shown.



Syntax show rmon event

Mode User Exec and Privileged Exec

Output Figure 84-1: Example output from the **show rmon event** command

```
awplus#sh rmon event
event Index = 787
  Description TRAP
  Event type log & trap
  Event community name gopher
  Last Time Sent = 0
  Owner RMON_SNMP

event Index = 990
  Description TRAP
  Event type trap
  Event community name teabo
  Last Time Sent = 0
  Owner RMON_SNMP
```

Note The following etherStats counters are not currently available for Layer 3 interfaces:



- etherStatsBroadcastPkts
- etherStatsCRCAlignErrors
- etherStatsUndersizePkts
- etherStatsOversizePkts
- etherStatsFragments
- etherStatslabbers
- etherStatsCollisions
- etherStatsPkts64Octets
- etherStatsPkts65to127Octets
- etherStatsPkts128to255Octets
- etherStatsPkts256to511Octets
- etherStatsPkts512to1023Octets
- etherStatsPkts1024to1518Octets

Example

```
awplus# show rmon event
```

Related Commands [rmon event](#)

show rmon history

Use this command to display the parameters specified on all the currently defined RMON history collections on the device.

Note Only the history for switch port interfaces, not for VLAN interfaces, can be shown.



Syntax `show rmon history`

Mode User Exec and Privileged Exec

Output [Figure 84-2: Example output from the show rmon history command](#)

```
awplus#sh rmon history
  history index = 56
    data source ifindex = 4501
    buckets requested = 34
    buckets granted = 34
    Interval = 2000
    Owner Andrew

  history index = 458
    data source ifindex = 5004
    buckets requested = 400
    buckets granted = 400
    Interval = 1500
    Owner trev
=====
```

Note The following etherStats counters are not currently available for Layer 3 interfaces:



- etherStatsBroadcastPkts
- etherStatsCRCAlignErrors
- etherStatsUndersizePkts
- etherStatsOversizePkts
- etherStatsFragments
- etherStatsJabbers
- etherStatsCollisions
- etherStatsPkts64Octets
- etherStatsPkts65to127Octets
- etherStatsPkts128to255Octets
- etherStatsPkts256to511Octets
- etherStatsPkts512to1023Octets
- etherStatsPkts1024to1518Octets

Example

```
awplus# show rmon history
```

Related Commands [rmon collection history](#)

show rmon statistics

Use this command to display the current values of the statistics for all the RMON statistics collections currently defined on the device.

Note Only statistics for switch port interfaces, not for VLAN interfaces, can be shown.



Syntax show rmon statistics

Mode User Exec and Privileged Exec

Example

```
awplus# show rmon statistics
```

Output Figure 84-3: Example output from the `show rmon statistics` command

```
awplus#show rmon statistics
rmon collection index 45
stats->ifindex = 4501
input packets 1279340, bytes 85858960, dropped 00, multicast packets 1272100
output packets 7306090, bytes 268724, multicast packets 7305660 broadcast
packets 290
rmon collection index 679
stats->ifindex = 5013
input packets 00, bytes 00, dropped 00, multicast packets 00
output packets 8554550, bytes 26777324, multicast packets 8546690 broadcast
packets 7720
```

Note The following etherStats counters are not currently available for Layer 3 interfaces:



- etherStatsBroadcastPkts
- etherStatsCRCAlignErrors
- etherStatsUndersizePkts
- etherStatsOversizePkts
- etherStatsFragments
- etherStatsJabbers
- etherStatsCollisions
- etherStatsPkts64Octets
- etherStatsPkts65to127Octets
- etherStatsPkts128to255Octets
- etherStatsPkts256to511Octets
- etherStatsPkts512to1023Octets
- etherStatsPkts1024to1518Octets

Related Commands rmon collection stats

Chapter 85: Triggers Introduction



Introduction.....	85.2
Configuring a Trigger	85.2
Troubleshooting Triggers.....	85.4

Introduction

The Trigger facility provides a powerful mechanism for automatic and timed management of your device by automating the execution of commands in response to certain events. For example, you can use triggers to deactivate a service during the weekends, or to collect diagnostic information when the CPU usage is high.

A *trigger* is an ordered sequence of scripts that is executed when a certain event occurs. A *script* is a sequence of commands stored as a plaintext file on a file subsystem accessible to the device, such as Flash memory. Each trigger may reference multiple scripts and any script may be used by any trigger. When an event activates a trigger, the trigger executes the scripts associated with it in sequence. One script is executed completely before the next script begins. Various types of triggers are supported, each activated in a different way.

Configuring a Trigger

The following describes the general steps to configure a trigger. For specific configuration examples, see [Chapter 86, Triggers Configuration](#).

Step 1: Create a configuration script

Create a configuration script with the commands you would like executed when the trigger conditions are met. To create the configuration script using the CLI, use the command:

```
awplus# edit [<filename>]
```

Alternatively, you can create a script on a PC then load it onto your device using the [copy \(URL\)](#) command.

Step 2: Enter the trigger configuration mode

You must be in the Global Configuration mode to reach the Trigger Configuration mode. Use the command:

```
awplus# configure terminal
```

To create a trigger, and enter its configuration mode, use the command:

```
awplus(config)# trigger <1-250>
```

Step 3: Set the trigger type

The trigger type determines how the trigger is activated. To set the trigger to activate:

« when CPU usage reaches a certain level, use the command:

```
awplus(config-trigger)# type cpu <1-100> [up|down|any]
```

« when the link status of a particular interface changes, use the command:

```
awplus(config-trigger)# type interface <interface> [up|down|any]
```

« when the RAM usage reaches a certain level, use the command:

```
awplus(config-trigger)# type memory <1-100> [up|down|any]
```

« periodically after a set number of minutes, use the command:

```
awplus(config-trigger)# type periodic <1-1440>
```

« when a ping poll identifies that a target device's status has changed, use the command:

```
awplus(config-trigger)# type ping-poll <1-100> {up|down}
```

« if your device reboots, use the command:

```
awplus(config-trigger)# type reboot
```

« when a stacking link goes up or down, use the command:

```
awplus(config-trigger)# type stack link {up|down}
```

« at a specific time of the day, use the command:

```
awplus(config-trigger)# type time <hh:mm>
```

Note that a combined limit of 10 triggers of the type periodic and type time can be configured. If you attempt to add more than 10 triggers the following error message is displayed:

```
% Cannot configure more than 10 triggers with the type time or periodic
```

Step 4: Set the time and days that the trigger can activate on

By default triggers can activate at any time of the day, on all days. If you want your trigger to activate only during a specific time of the day, use the command:

```
awplus(config-trigger)# time {[after <hh:mm:ss>] [before <hh:mm:ss>]}
```

If you want your trigger to activate only on a specific date, use the command:

```
awplus(config-trigger)# day <1-31> <month> <2000-2035>
```

If you want the trigger to activate only on specific days of the week, use the command:

```
awplus(config-trigger)# day <weekday>
```

Note that you can set either a specific date, or specific weekdays, but not both.

Step 5: Specify how often the trigger can activate

By default, triggers can activate an unlimited number of times, as long as the trigger conditions are met. To set a limit on the number of times a trigger can activate, use the command:

```
awplus(config-trigger)# repeat {forever|no|once|yes|<1-4294967294>}
```

You device maintains two counters that track the number of times a trigger has activated. One counts the total number of times the trigger is activated and is only reset if the device restarts, or when the trigger is destroyed. The other counter tracks the permitted number of repetitions. To reset this counter, use the [repeat command on page 87.6](#).

Step 6: Add the script to the trigger

You can add up to five scripts to the trigger. When a trigger is activated, it executes the scripts in sequence, with the lowest numbered script activated first. The first script runs to completion before the next script begins. To add a script, use the command:

```
awplus(config-trigger)# script <1-5> {<filename>}
```

Step 7: Specify a description for the trigger

Specify a description for the trigger, so that you can easily identify the trigger in show commands and log output. Use the command:

```
awplus(config-trigger)# description <description>
```

Step 8: Verify the trigger's configuration

To check the configuration of the trigger, use the command:

```
awplus(config-trigger)# show trigger [<1-250>|counter|full]
```

Troubleshooting Triggers

You can use the trigger diagnostic mode and trigger debugging to test your triggers and troubleshoot any issues.

Diagnostic mode is set per trigger. In this mode the trigger activates if its trigger conditions are met, but does not run any of its scripts. Your device generates a log message to indicate that the trigger was activated. To place a trigger in diagnostic mode, enter the trigger's configuration mode and use the command:

```
awplus(config-trigger)# test
```

To start debugging for triggers, use the command:

```
awplus(config-trigger)# debug trigger
```

This generates detailed messages about how your device is processing the trigger commands and activating the triggers.

Enabling and Disabling

Triggers are enabled by default. This allows the trigger to activate as soon as its trigger conditions are met. If you need to disable a trigger but do not want to delete the trigger, use the command:

```
awplus(config-trigger)# no active
```

To enable the trigger again, use the command:

```
awplus(config-trigger)# active
```

To delete the trigger, use the command:

```
awplus(config-trigger)# no trigger <1-250>
```

Chapter 86: Triggers Configuration



Introduction.....	86.2
Restrict Internet Access	86.2
Capturing Unusual CPU and RAM Activity.....	86.3
Seeing Daily Statistics.....	86.5

Introduction

The chapter describes how to configure triggers to:

- restricting internet access during work hours
- change the gateway set when a device becomes unreachable
- tracking unusual CPU or RAM usage by your device

For more information about triggers, see [Chapter 85, Triggers Introduction](#) and [Chapter 87, Trigger Commands](#).

Restrict Internet Access

In the following configuration the ACME company wants to restrict its employees from accessing popular video sharing websites as this is causing bandwidth problems during work hours. The ACME company is happy for workers to access the site after work hours.

Employee PCs at ACME are on vlan2. Two triggers with associated scripts are needed:

- Trigger one activates at 8.30am and runs a script called shutdown.scp. This script adds commands to restrict access to the specified sites
- Trigger two activates at 5.30pm and runs the script called open.scp. This script removes the configuration specified by shutdown.scp.

1. Create the shutdown.scp script

Create a configuration script using Access Control List commands to restrict users on vlan2 from accessing the specific sites.

2. Create the open.scp script

Create a script to remove the ACL configuration specified in the shutdown.cfg file.

3. Configure trigger 1

To create trigger one, use the command:

```
awplus(config)#trigger 1
```

Set the trigger to activate at 8:30 am, by using the command:

```
awplus(config-trigger)#type time 08:30
```

Set the trigger to activate on Monday, Tuesday, Wednesday, Thursday and Friday:

```
awplus(config-trigger)#day mon tue wed thur fri
```

Add the script **shutdown.scp** to the trigger, by using the command:

```
awplus(config-trigger)#script 1 shutdown.scp
```

Specify a helpful description, such as **stops access to video sharing sites**.

Use the command:

```
awplus(config-trigger)#description stops access to video sharing sites
```

4. Configure trigger 2

To create trigger two, use the command:

```
awplus(config)#trigger 1
```

Set the trigger to activate at 5.30pm:

```
awplus(config-trigger)#type time 17:30
```

Set the trigger to activate on Monday, Tuesday, Wednesday, Thursday and Friday:

```
awplus(config-trigger)#day mon tue wed thur fri
```

To add the script `open.scp`, use the command:

```
awplus(config-trigger)#script 1 open.scp
```

Specify a helpful description, such as access **allowed to video sharing sites**. Use the command:

```
awplus(config-trigger)#description access allowed to video  
sharing sites
```

5. Verify the configuration

To check the configuration of the triggers, use the command:

```
awplus#show trigger
```

Capturing Unusual CPU and RAM Activity

The following configuration allows you to troubleshoot high CPU or RAM usage by the device. It uses two triggers to capture show output, and places this output in a file.

- Trigger three activates the script `cpu-usage.scp` when CPU usage is over 90% and can activate up to 5 times
- Trigger four activates the script `ram-usage.scp` when RAM usage is over 95%, and can activate up to 10 times

1. Create the `cpu-usage.scp` configuration script

Create a script with the appropriate show command:

```
awplus#show cpu | redirect showcpu.txt
```

The output of the `show cpu` command has been redirected into a file. It is not possible to display trigger script output on the terminal. Redirecting the command output to a file means it is available for later inspection.

If the trigger activates on more than one occasion the contents of `showcpu.txt` will be overwritten with the latest output. To keep a full record for all activations of this trigger an ASH shell script can be added to the trigger to manage the output of the configuration script. For example:

```
#!/bin/ash  
date >> showcpu_bkup.txt  
cat showcpu.txt >> showcpu_bkup.txt
```

This script concatenates that date and time of activation and the contents of `showcpu.txt` onto the end of the backup file `showcpu_bkup.txt` in flash memory.

Note that the files may grow large accumulating data and consume available flash memory.

2. Create the `ram-usage.scp` configuration script

Create a script with the appropriate show command:

```
awplus#show memory | redirect showmem.txt
```

The output of the **show memory** command has been redirected into a file. It is not possible to display trigger script output on the terminal. Redirecting the command output to a file means it is available for later inspection.

If the trigger activates on more than one occasion the contents of **showcpu.txt** will be overwritten with the latest output. To keep a full record for all activations of this trigger an ASH shell script can be added to the trigger to manage the output of the configuration script. For example:

```
#!/bin/ash
date >> showmem_bkup.txt
cat showmem.txt >> showmem_bkup.txt
```

This script concatenates that date and time of activation and the contents of **showmem.scp** onto the end of the backup file **showmem_bkup.scp** in flash memory.

Note that the files may grow large accumulating data and consume available flash memory.

3. Configure trigger 3

To create trigger three, use the command:

```
awplus(config)#trigger 3
```

Set the trigger to activate when CPU usage exceeds 80%, use the command:

```
awplus(config-trigger)#type cpu 90 up
```

Add the script **cpu-usage.scp** to the trigger, by using the command:

```
awplus(config-trigger)#script 1 cpu-usage.scp
```

4. Configure trigger 4

To create trigger four, use the command:

```
awplus(config)#trigger 4
```

Set the trigger to activate when RAM usage exceeds 95%, use the command:

```
awplus(config-trigger)#type cpu 95 up
```

Add the script **cpu-usage.scp** to the trigger, by using the command:

```
awplus(config-trigger)#script 1 ram-usage.scp
```

5. Verify the configuration

To check the configuration of the triggers, use the command:

```
awplus#show trigger
```

Seeing Daily Statistics

The ACME company has recently set up QoS on its traffic to give traffic different priorities to the ISP. ACME wants to assess how much traffic is dropped with the QoS bandwidths set over the next week. To do this, they want to generate an hourly report on QoS traffic on the first day that this is implemented.

- Trigger five activates the script `qos-stats.scp` every 60 minutes. The trigger is set to only activate during work hours.

1. Create the `qos-stats.scp` script

Create a configuration script with the appropriate show commands.

2. Configure trigger 5

To create trigger five, use the command:

```
awplus(config)#trigger 5
```

Set the trigger to activate periodically every 60 minutes:

```
awplus(config-trigger)#type periodic 60
```

Set the trigger to activate only during the hours of 8:00am and 6:00pm:

```
awplus(config-trigger)#time after 8:00 before 18:00
```

Add the script `qos-stats.scp` to the trigger, by using the command:

```
awplus(config-trigger)#script 1 qos-stats.scp
```

3. Verify the configuration

To check the configuration of the triggers, use the command:

```
awplus#show trigger
```

Chapter 87: Trigger Commands



Command List	87.2
active (trigger)	87.2
day	87.3
debug trigger	87.4
description (trigger)	87.5
repeat	87.6
script	87.7
show running-config trigger	87.8
show trigger	87.9
test	87.13
time (trigger)	87.14
trap	87.16
trigger	87.17
trigger activate	87.18
type cpu	87.19
type interface	87.20
type memory	87.21
type periodic	87.22
type ping-poll	87.23
type reboot	87.23
type stack disabled-master	87.24
type stack master-fail	87.25
type stack member	87.26
type stack link	87.27
type time	87.28
undebg trigger	87.28

Command List

This chapter provides an alphabetical reference for commands used to configure Triggers. For more information, see [Chapter 85, Triggers Introduction](#) and [Chapter 86, Triggers Configuration](#).

For information about modifying or redirecting the output from **show** commands to a file, see [“Controlling “show” Command Output” on page 1.35](#).

active (trigger)

This command enables a trigger. This allows the trigger to activate when its trigger conditions are met.

The **no** variant of this command disables a trigger. While in this state the trigger cannot activate when its trigger conditions are met.

Syntax active
 no active

Mode Trigger Configuration

Examples To enable trigger 172, so that it can activate when its trigger conditions are met, use the commands:

```
awplus# configure terminal
awplus(config)# trigger 172
awplus(config-trigger)# active
```

To disable trigger 182, preventing it from activating when its trigger conditions are met, use the commands:

```
awplus# configure terminal
awplus(config)# trigger 182
awplus(config-trigger)# no active
```

Related Commands [show trigger](#)
 [trigger](#)

day

This command specifies the days or date that the can trigger activate on. You can specify either:

- A specific date
- A specific day of the week
- A list of days of the week
- every day

By default, the trigger can activate on any day.

Syntax `day every-day`

`day <1-31> <month> <2000-2035>`

`day <weekday>`

Parameter	Description
<code>every-day</code>	Sets the trigger so that it can activate on any day.
<code><1-31></code>	Day of the month the trigger is permitted to activate on.
<code><month></code>	Sets the month that the trigger is permitted to activate on. Valid keywords are: january, february, march, april, may, june, july, august, september, october, november, and december.
<code><2000-2035></code>	Sets the year that the trigger is permitted to activate in.
<code><weekday></code>	Sets the days of the week that the trigger can activate on. You can specify one or more week days in a space separated list. Valid keywords are: monday, tuesday, wednesday, thursday, friday, saturday, and sunday.

Mode Trigger Configuration

Examples To permit trigger 55 to activate on the 1st of June 2008, use the commands:

```
awplus# configure terminal
awplus(config)# trigger 55
awplus(config-trigger)# day 1 Jun 2008
```

To permit trigger 12 to activate on a Mondays, Wednesdays and Fridays, use the commands:

```
awplus# configure terminal
awplus(config)# trigger 12
awplus(config-trigger)# day monday wednesday friday
```

Related Commands `show trigger`
`trigger`

debug trigger

This command enables trigger debugging. This generates detailed messages about how your device is processing the trigger commands and activating the triggers.

The **no** variant of this command disables trigger debugging.

Syntax `debug trigger`

`no debug trigger`

Mode Privilege Exec

Examples To start trigger debugging, use the command:

```
awplus# debug trigger
```

To stop trigger debugging, use the command:

```
awplus# no trigger
```

Related Commands `show trigger`
`test`
`trigger`
`undebug trigger`

description (trigger)

This command adds an optional description to help you identify the trigger. This description is displayed in show command outputs and log messages.

The **no** variant of this command removes a trigger's description. The show command outputs and log messages stop displaying a description for this trigger.

Syntax `description <description>`

`no description`

Parameter	Description
<code><description></code>	A word or phrase that uniquely identifies this trigger or its purpose. Valid characters are any printable character and spaces, up to a maximum of 40 characters.

Mode Trigger Configuration

Examples To give trigger 240 the description `daily status report`, use the commands:

```
awplus# configure terminal
awplus(config)# trigger 240
awplus(config-trigger)# description daily status report
```

To remove the description from trigger 36, use the commands:

```
awplus# configure terminal
awplus(config)# trigger 36
awplus(config-trigger)# no description
```

Related Commands `show trigger`
`test`
`trigger`

repeat

This command specifies the number of times that a trigger is permitted to activate. This allows you to specify whether you want the trigger to activate:

- only the first time that the trigger conditions are met
- a limited number of times that the trigger conditions are met
- an unlimited number of times

Once the trigger has reached the limit set with this command, the trigger remains in your configuration but cannot be activated. Use the **repeat** command again to reset the trigger so that it is activated when its trigger conditions are met.

By default, triggers can activate an unlimited number of times. To reset a trigger to this default, specify either **yes** or **forever**.

Syntax `repeat {forever|no|once|yes|<1-4294967294>}`

Parameter	Description
<code>yes forever</code>	The trigger repeats indefinitely, or until disabled.
<code>no once</code>	The trigger activates only once.
<code><1-4292967294></code>	The trigger repeats the set number of times.

Mode Trigger Configuration

Examples To allow trigger 21 to activate only once, use the commands:

```
awplus# configure terminal
awplus(config)# trigger 21
awplus(config-trigger)# repeat no
```

To allow trigger 22 to activate an unlimited number of times whenever its trigger conditions are met, use the commands:

```
awplus# configure terminal
awplus(config)# trigger 22
awplus(config-trigger)# repeat forever
```

To allow trigger 23 to activate only the first 10 times the conditions are met, use the commands:

```
awplus# configure terminal
awplus(config)# trigger 23
awplus(config-trigger)# repeat 10
```

Related Commands [show trigger](#)
[trigger](#)

script

This command specifies one or more scripts that are to be run when the trigger activates. You can add up to five scripts to a single trigger.

The sequence in which the trigger runs the scripts is specified by the number you set before the name of the script file. One script is executed completely before the next script begins.

Scripts may be either ASH shell scripts, indicated by a `.sh` filename extension suffix, or AlliedWare Plus™ scripts, indicated by a `.scp` filename extension suffix. AlliedWare Plus™ scripts only need to be readable.

The **no** variant of this command removes one or more scripts from the trigger's script list. The scripts are identified by either their name, or by specifying their position in the script list. The **all** parameter removes all scripts from the trigger.

Syntax

```
script <1-5> {<filename>}
no script {<1-5>|<filename>|all}
```

Parameter	Description
<1-5>	The position of the script in execution sequence. The trigger runs the lowest numbered script first.
<filename>	The path to the script file.

Mode Trigger Configuration

Examples To configure trigger 71 to run the script `flash:/cpu_trig.sh` in position 3 when the trigger activates, use the commands:

```
awplus# configure terminal
awplus(config)# trigger 71
awplus(config-trigger)# script 3 flash:/cpu_trig.sh
```

To configure trigger 99 to run the scripts `flash:reconfig.scp`, `flash:cpu_trig.sh` and `flash:email.scp` in positions 2, 3 and 5 when the trigger activates, use the following commands:

```
awplus# configure terminal
awplus(config)# trigger 99
awplus(config-trigger)# script 2 flash:/reconfig.scp 3 flash:/
cpu_trig.sh 5 flash:/email.scp
```

To remove the scripts 1, 3 and 4 from trigger 71's script list, use the commands:

```
awplus# configure terminal
awplus(config)# trigger 71
awplus(config-trigger)# no script 1 3 4
```

To remove the script flash:/cpu_trig.sh from trigger 71's script list, use the commands:

```
awplus# configure terminal
awplus(config)# trigger 71
awplus(config-trigger)# no script flash:/cpu_trig.sh
```

To remove all the scripts from trigger 71's script list, use the commands:

```
awplus# configure terminal
awplus(config)# trigger 71
awplus(config-trigger)# no script all
```

Related Commands [show trigger](#)
[trigger](#)

show running-config trigger

This command displays the current running configuration of the trigger utility.

Syntax `show running-config trigger`

Mode Privileged Exec

Example To display the current configuration of the trigger utility, use the command:

```
awplus# show running-config trigger
```

Related Commands [show trigger](#)

show trigger

This command displays configuration and diagnostic information about the triggers configured on the device. Specify the **show trigger** command without any options to display a summary of the configuration of all triggers.

Syntax `show trigger [<1-250>|counter|full]`

Parameter	Description
<1-250>	Displays detailed information about a specific trigger, identified by its trigger ID.
counter	Displays statistical information about all triggers.
full	Displays detailed information about all triggers.

Mode Privileged Exec

Example To get summary information about all triggers, use the following command:

```
awplus# show trigger
```

Figure 87-1: Example output from the **show trigger** command

TR#	Type & Details	Name	Ac	Te	Repeat	#Scr	Days/Date
001	CPU (80% any)	Busy CPU	Y	N	5	1	smtwtfs
005	Periodic (30 min)	Regular status check	Y	N	Continuous	1	-mtwtf-
007	Memory (85% up)	High mem usage	Y	N	8	1	smtwtfs
011	Time (00:01)	Weekend access	Y	N	Continuous	1	-----s
013	Reboot		Y	N	Continuous	2	smtwtfs
017	Interface (vlan1 ...	Change config for...	Y	N	Once	1	2-apr-2008
019	Ping-poll (5 up)	Connection to svr1	Y	N	Continuous	1	smtwtfs

Table 87-1: Parameters in the output of the **show trigger** command

Parameter	Description
TR#	Trigger identifier (ID).
Type & Details	The trigger type, followed by the trigger details in brackets.
Name	Descriptive name of the trigger configured with the description (trigger) command.
Ac	Whether the trigger is active (Y), or inactive (N).
Te	Whether the trigger is in test mode (Y) or not (N).
Repeat	Whether the trigger repeats continuously, and if not, the configured repeat count for the trigger. To see the number of times a trigger has activated, use the show trigger <1-250> command.
#Scr	Number of scripts associated with the trigger.
Days/Date	Days or date when the trigger may be activated. For the days options, the days are shown as a seven character string representing Sunday to Saturday. A hyphen indicates days when the trigger cannot be activated.

To display detailed information about trigger 1, use the command:

```
awplus# show trigger 1
```

Figure 87-2: Example output from the **show trigger** command for a specific trigger

```
awplus#show trigger 1

Trigger Configuration Details
-----
Trigger ..... 1
Description ..... dispaly cpu usage when pass 80%
Type and details ..... CPU (80% up)
Days ..... 26-nov-2007
After ..... 00:00:00
Before ..... 23:59:59
Active ..... Yes
Test ..... No
Repeat ..... 123 (0)
Modified ..... Tue Dec 20 02:26:03 1977
Number of activations ..... 0
Last activation ..... not activated
Number of scripts ..... 1
    1. shocpu.scp
    2. <not configured>
    3. <not configured>
    4. <not configured>
    5. <not configured>
-----
```

To display detailed information about all triggers, use the command:

```
awplus# show trigger full
```

Figure 87-3: Example output from the **show trigger full** command

```
Trigger Configuration Details
-----
Trigger ..... 1
Name ..... Busy CPU
Type and details ..... CPU (80% up)
Days ..... smtwtfS
Active ..... Yes
Test ..... No
Repeat ..... Continuous
Modified ..... Fri Feb 2 17:05:16 2007
Number of activations ..... 0
Last activation ..... not activated
Number of scripts ..... 2
    1. flash:/cpu_alert.sh
    2. flash:/reconfig.scp
    3. <not configured>
    4. <not configured>
    5. <not configured>

Trigger ..... 5
Name ..... Regular status check
Type and details ..... Periodic (30 min)
Days ..... smtwtfS
Active ..... Yes
Test ..... No
Repeat ..... 5 (2)
Modified ..... Fri Feb 2 17:18:44 2007
Number of activations ..... 0
Last activation ..... Fri Feb 2 18:00:00 2007
```

Figure 87-3: Example output from the **show trigger full** command (cont.)

```

Number of scripts ..... 1
  1. flash:/stat_check.scp
  2. <not configured>
  3. <not configured>
  4. <not configured>
  5. <not configured>
-----
    
```

 Table 87-2: Parameters in the output of the **show trigger full** and **show trigger** commands for a specific trigger

Parameter	Description
Trigger	The ID of the trigger.
Description/ Name	Descriptive name of the trigger.
Type and details	The trigger type and its activation conditions.
Days	The days on which the trigger is permitted to activate.
Date	The date on which the trigger is permitted to activate. Only displayed if configured, in which case it replaces "Days".
Active	Whether or not the trigger is permitted to activate.
Test	Whether or not the trigger is operating in diagnostic mode.
Repeat	Whether the trigger repeats an unlimited number of times (Continuous) or for a set number of times. When the trigger can repeat only a set number of times, then the number of times the trigger has been activated is displayed in brackets.
Modified	The date and time of the last time that the trigger was modified.
Number of activations	Number of times the trigger has been activated since the last restart of the device.
Last activation	The date and time of the last time that the trigger was activated.
Number of scripts	How many scripts are associated with the trigger, followed by the names of the script files in the order in which they run.

To display counter information about all triggers use the command:

```
awplus# show trigger counter
```

Figure 87-4: Example output from the `show trigger counter` command

```
awplus#show trigger counter

Trigger Module Counters
-----
Trigger activations ..... 0
Time triggers activated today ..... 0
Periodic triggers activated today ..... 0
Interface triggers activated today ..... 0
Resource triggers activated today ..... 0
Reboot triggers activated today ..... 0
Ping-poll triggers activated today ..... 0
Stack master fail triggers activated today .... 0
Stack member triggers activated today ..... 0
Stack xem-stk triggers activated today ..... 0
-----
```

Table 87-3: Parameters in the output of the `show trigger counter` command

Parameter	Description
Trigger activations	Number of times a trigger has been activated.
Time triggers activated today	Number of times a time trigger has been activated today.
Periodic triggers activated today	Number of times a periodic trigger has been activated today.
Interface triggers activated today	Number of times an interface trigger has been activated today.
Resource triggers activated today	Number of times a CPU or memory resource trigger has been activated today.
Ping-poll triggers activated today	Number of times a ping-poll trigger has been activated today.

Related Commands `trigger`

test

This command puts the trigger into a diagnostic mode. In this mode the trigger may activate but when it does it will not run any of the trigger's scripts. A log message will be generated to indicate when the trigger has been activated.

The **no** variant of this command takes the trigger out of diagnostic mode, restoring normal operation. When the trigger activates the scripts associated with the trigger will be run, as normal.

Syntax test
no test

Mode Trigger Configuration

Examples To put trigger 5 into diagnostic mode, where no scripts will be run when the trigger activates, use the commands:

```
awplus# configure terminal
awplus(config)# trigger 5
awplus(config-trigger)# test
```

To take trigger 205 out of diagnostic mode, restoring normal operation, use the commands:

```
awplus# configure terminal
awplus(config)# trigger 205
awplus(config-trigger)# no test
```

Related Commands show trigger
trigger

time (trigger)

This command specifies the time of day when the trigger is permitted to activate. The **after** parameter specifies the start of a time period that extends to midnight during which trigger may activate. By default the value of this parameter is 00:00:00 (am); that is, the trigger may activate at any time. The **before** parameter specifies the end of a time period beginning at midnight during which the trigger may activate. By default the value of this parameter is 23:59:59; that is, the trigger may activate at any time. If the value specified for **before** is later than the value specified for **after**, a time period from "after" to "before" is defined, during which the trigger may activate. This command is not applicable to time triggers (**type time**).

The following figure illustrates how the **before** and **after** parameters operate.

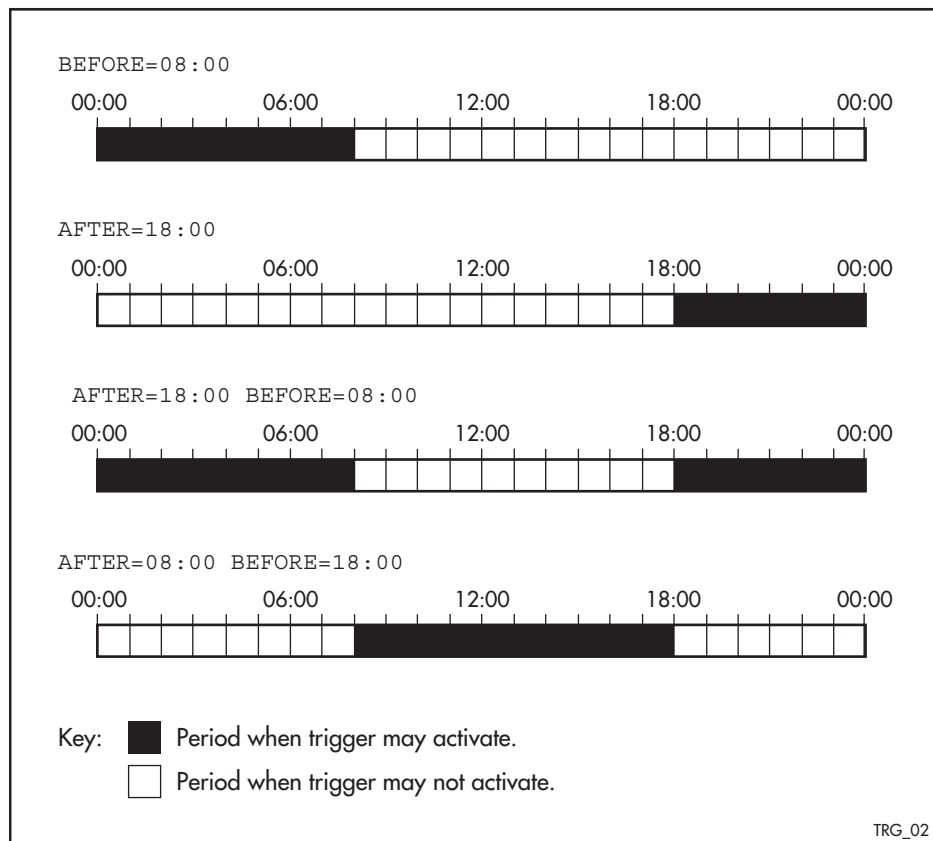

Syntax `time {[after <hh:mm:ss>] [before <hh:mm:ss>]}`

Parameter	Description
<code>after <hh:mm:ss></code>	The earliest time of day when the trigger may be activated.
<code>before <hh:mm:ss></code>	The latest time of day when the trigger may be activated.

Mode Trigger Configuration

Examples To allow trigger 63 to activate between midnight and 10:30am, use the commands:

```
awplus# configure terminal
awplus(config)# trigger 63
awplus(config-trigger)# time before 10:30:00
```

To allow trigger 64 to activate between 3:45pm and midnight, use the commands:

```
awplus# configure terminal
awplus(config)# trigger 64
awplus(config-trigger)# time after 15:45:00
```

To allow trigger 65 to activate between 10:30am and 8:15pm, use the commands:

```
awplus# configure terminal
awplus(config)# trigger 65
awplus(config-trigger)# time after 10:30:00 before 20:15:00
```

Related Commands [show trigger](#)
[trigger](#)

trap

This command enables the specified trigger to send SNMP traps.

Use the **no** variant of this command to disable the sending of SNMP traps from the specified trigger.

Syntax trap

no trap

Default SNMP traps are enabled by default for all defined triggers.

Mode Trigger Configuration

Usage You must configure SNMP before using traps with triggers. See the following SNMP chapters:

[Chapter 77, SNMP Introduction](#)

[Chapter 78, SNMP Commands](#)

[Chapter 79, SNMP MIBs](#)

Since SNMP traps are enabled by default for all defined triggers, a common usage will be for the **no** variant of this command to disable SNMP traps from a specified trap if the trap is only periodic. Refer in particular to [AT-TRIGGER-MIB](#) for further information about the relevant SNMP MIB.

Examples To enable SNMP traps to be sent from trigger 5, use the commands:

```
awplus# configure terminal
awplus(config)# trigger 5
awplus(config-trigger)# trap
```

To disable SNMP traps being sent from trigger 205, use the commands:

```
awplus# configure terminal
awplus(config)# trigger 205
awplus(config-trigger)# no trap
```

Related Commands trigger
show trigger

trigger

This command is used to access the Trigger Configuration mode for the specified trigger. Once Trigger Configuration mode has been entered the trigger type information can be configured and the trigger scripts and other operational parameters can be specified. At a minimum the trigger type information must be specified before the trigger can become active.

The **no** variant of this command removes a specified trigger and all configuration associated with it.

Syntax `trigger <1-250>`
`no trigger <1-250>`

Parameter	Description
<code><1-250></code>	A trigger ID.

Mode Global Configuration

Examples To enter trigger configuration mode for trigger 12 use the command:

```
awplus# trigger 12
```

To completely remove all configuration associated with trigger 12, use the command:

```
awplus# no trigger 12
```

Related Commands `show trigger`
`trigger activate`

trigger activate

This command is used to manually activate a specified trigger from the Privileged Exec mode, which has been configured with the **trigger** command from the Global Configuration mode.

Syntax `trigger activate <1-250>`

Parameter	Description
<1-250>	A trigger ID.

Mode Privileged Exec

Usage This command manually activates a trigger without the normal trigger conditions being met.

The trigger is activated even if it is configured as inactive. The scripts associated with the trigger will be executed even if the trigger is in the diagnostic test mode.

Triggers activated manually do not have their repeat counts decremented or their 'last triggered' time updated, and do not result in updates to the '[type] triggers today' counters.

Example To manually activate trigger 12 use the command:

```
awplus# trigger activate 12
```

Related Commands `show trigger`
`trigger`

type cpu

This command configures a trigger to activate based on CPU usage level. Selecting the **up** option causes the trigger to activate when the CPU usage exceeds the specified usage level. Selecting the **down** option causes the trigger to activate when CPU usage drops below the specified usage level. Selecting **any** causes the trigger to activate in both situations. The default value is **any**.

Syntax `type cpu <1-100> [up|down|any]`

Parameter	Description
<1-100>	The percentage of CPU usage at which to trigger.
up	Activate when CPU usage exceeds the specified level.
down	Activate when CPU usage drops below the specified level
any	Activate when CPU usage passes the specified level in either direction

Mode Trigger Configuration

Examples To configure trigger 28 to be a CPU trigger that activates when CPU usage exceeds 80% use the following commands:

```
awplus# configure terminal
awplus(config)# trigger 28
awplus(config-trigger)# type cpu 80 up
```

To configure trigger 5 to be a CPU trigger that activates when CPU usage either rises above or drops below 65%, use the following commands:

```
awplus# configure terminal
awplus(config)# trigger 5
awplus(config-trigger)# type cpu 65
```

or

```
awplus# configure terminal
awplus(config)# trigger 5
awplus(config-trigger)# type cpu 65 any
```

Related Commands `show trigger`
`trigger`

type interface

This command configures a trigger to activate based on the link status of an interface. The trigger can be activated when the interface becomes operational by using the **up** option, or when the interface closes by using the **down** option. The trigger can also be configured to activate when either one of these events occurs by using the **any** option.

Syntax `type interface <interface> [up|down|any]`

Parameter	Description
<interface>	Interface name. This can be the name of a switch port, an eth-management port, or a VLAN.
up	Activate when interface becomes operational.
down	Activate when the interface closes.
any	Activate when any interface link status event occurs.

Mode Trigger Configuration

Example To configure trigger 19 to be an interface trigger that activates when port1.1.2 becomes operational, use the following commands:

```
awplus# configure terminal
awplus(config)# trigger 19
awplus(config-trigger)# type interface port1.1.2 up
```

Related Commands `show trigger`
`trigger`

type memory

This command configures a trigger to activate based on RAM usage level. Selecting the **up** option causes the trigger to activate when memory usage exceeds the specified level. Selecting the **down** option causes the trigger to activate when memory usage drops below the specified level. Selecting **any** causes the trigger to activate in both situations. The default value is **any**.

Syntax `type memory <1-100> [up|down|any]`

Parameter	Description
<1-100>	The percentage of memory usage at which to trigger.
up	Activate when memory usage exceeds the specified level.
down	Activate when memory usage drops below the specified level.
any	Activate when memory usage passes the specified level in either direction.

Mode Trigger Configuration

Examples To configure trigger 12 to be a memory trigger that activates when memory usage exceeds 50% use the following commands:

```
awplus# configure terminal
awplus(config)# trigger 12
awplus(config-trigger)# type memory 50 up
```

To configure trigger 40 to be a memory trigger that activates when memory usage either rises above or drops below 65%, use the following commands:

```
awplus# configure terminal
awplus(config)# trigger 40
awplus(config-trigger)# type memory 65
```

or

```
awplus# configure terminal
awplus(config)# trigger 40
awplus(config-trigger)# type memory 65 any
```

Related Commands `show trigger`
`trigger`

type periodic

This command configures a trigger to be activated at regular intervals. The time period between activations is specified in minutes.

Syntax `type periodic <1-1440>`

Parameter	Description
<code><1-1440></code>	The number of minutes between activations.

Mode Trigger Configuration

Usage A combined limit of 10 triggers of the type periodic and time can be configured. If you attempt to add more than 10 triggers the following error message is displayed:

```
% Cannot configure more than 10 triggers with the type time or
periodic
```

Example To configure trigger 44 to activate periodically at 10 minute intervals use the following commands:

```
awplus# configure terminal
awplus(config)# trigger 44
awplus(config-trigger)# type periodic 10
```

Related Commands `show trigger`
`trigger`

type ping-poll

This command configures a trigger that activates when Ping Polling identifies that a target device's status has changed. This allows you to run a configuration script when a device becomes reachable or unreachable.

Syntax `type ping-poll <1-100> {up|down}`

Parameter	Description
<1-100>	The ping poll ID.
up	The trigger activates when ping polling detects that the target is reachable.
down	The trigger activates when ping polling detects that the target is unreachable.

Mode Trigger Configuration

Example To configure trigger 106 to activate when ping poll 12 detects that its target device is now unreachable, use the following commands:

```
awplus# configure terminal
awplus(config)# trigger 106
awplus(config-trigger)# type ping-poll 12 down
```

Related Commands `show trigger`
`trigger`

type reboot

This command configures a trigger that activates when your device is rebooted.

Syntax `type reboot`

Mode Trigger Configuration

Example To configure trigger 32 to activate when your device reboots, use the following commands:

```
awplus# configure terminal
awplus(config)# trigger 32
awplus(config-trigger)# type reboot
```

Related Commands `show trigger`
`trigger`

type stack disabled-master

This command (configured to the stack) configures a trigger to activate on a stack member if it becomes the disabled master.

A disabled master has the same configuration as the active master, but has all its links shutdown.

Although this command could activate any trigger script, the intention here is that the script will reactivate the links from their previously shutdown state, to enable the user to manage the switch. An appropriate trigger script must already exist that will apply the [no shutdown command on page 12.12](#) on the deactivated links.

Syntax type stack disabled-master

Mode Trigger Configuration

Examples To configure trigger 82 to activate on a device if it becomes the disabled master, use the commands:

Command	Description
awplus# configure terminal	Enter the Global Configuration mode
awplus(config)# trigger 82	Enter the Trigger Configuration mode for trigger 82
awplus(config-trigger)# type stack disabled master	Sets the type of trigger
awplus(config-trigger)# script 1 flash:/disabled.scp	
awplus(config-trigger)# exit	

Related Commands trigger
type stack member
type stack link

type stack master-fail

This command (configured to the stack) initiates the action of a pre-configured trigger to occur when the stack enters the fail-over state.

Syntax `type stack master-fail`

Mode Trigger Configuration

Example To configure trigger 86 to activate when stack master fail-over event occurs, use the commands:

```
awplus# configure terminal
awplus(config)# trigger 86
awplus(config-trigger)# type stack master-fail
```

Related Commands [trigger](#)
[type stack member](#)
[type stack link](#)

type stack member

This command (configured to the stack) initiates the action of a pre-configured trigger to occur when a switch either joins or leaves the stack.

Syntax type stack member {join|leave}

Parameter	Description
join	Neighbor join event
leave	Neighbor leave event

Mode Trigger Configuration

Example To configure a pre-configured trigger number 86 to activate when a new switch joins the stack Note that the number 86 has no particular significance; you can assign any (previously created) numbered trigger

```
awplus# configure terminal
awplus(config)# trigger 86
awplus(config-trigger)# type stack member join
```

Related Commands trigger
type stack master-fail
type stack link

type stack link

This command (configured to the stack) initiates the action of a pre-configured trigger to occur when a stacking link is either activated or deactivated.

Syntax `type stack link {up|down}`

Parameter	Description
up	Stack link up event
down	Stack link down event

Mode Trigger Configuration

Example To configure trigger 86 to activate when the stack link down event occurs, use the commands:

```
awplus# configure terminal
awplus(config)# trigger 86
awplus(config-trigger)# type stack link down
```

Related Commands `show trigger`
`trigger`
`type stack master-fail`

type time

This command configures a trigger that activates at a specified time of day.

Syntax `type time <hh:mm>`

Parameter	Description
<code><hh:mm></code>	The time to activate the trigger.

Mode Trigger Configuration

Usage A combined limit of 10 triggers of the type time and type periodic can be configured. If you attempt to add more than 10 triggers the following error message is displayed:

```
% Cannot configure more than 10 triggers with the type time or
periodic
```

Example To configure trigger 86 to activate at 15:53, use the following commands:

```
awplus# configure terminal
awplus(config)# trigger 86
awplus(config-trigger)# type time 15:53
```

Related Commands `show trigger`
`trigger`

undebug trigger

This command applies the functionality of the [no debug trigger command on page 87.4](#).

Chapter 88: Ping Polling Introduction



Introduction.....	88.2
How Ping Polling Works	88.2
Configuring Ping Polling.....	88.4
Creating a Polling Instance	88.4
Customizing a Polling Instance.....	88.5
Troubleshooting Ping Polling	88.6
Interaction with Other Protocols.....	88.6

Introduction

Ping polling lets your device regularly check whether it can reach other hosts on a network. It works by sending ICMP Echo Requests to a host and waiting for replies sent back. If ping polling indicates that a host's status has changed, then your device can respond to the new status. When a host is unreachable, ping polling continues monitoring the host's reachability.

You can configure triggers to activate when ping polling determines that the host's status has changed. For example, you could configure a trigger to run a script that opens and configures an alternative link if the host at the other end of a preferred link becomes unavailable. You could then configure a second trigger to run a script that automatically returns traffic to the preferred link as soon as it is available again.

How Ping Polling Works

To determine a host's reachability, your device regularly sends ICMP Echo Request packets ("pings") to the host. As long as your device receives ping responses from the host, it considers the host to be reachable. If your device does not receive a reply to a set number of ICMP Echo Requests, it considers that the host is unreachable. It continues to try to ping the device, at an increased rate. After it receives a set number of responses, it considers the device to be reachable again.

By default, a polling instance sends a ping every 30 seconds as long as it is receiving replies. The frequency of this polling is controlled by the **normal-interval** command. When a reply is not received, the polling instance increases the frequency at which it polls the device. This frequency is controlled by the **critical-interval** command, and by default, is set to send a packet every one second. It maintains this higher rate of polling until it has received sufficient consecutive replies.

The polling instance determines whether a device is reachable or unreachable based on the settings of the **fail-count**, **sample-size**, and **up-count** commands. To determine whether a device is reachable, the polling instance counts the number of failed pings within a set sample size. The sample size is set by the **sample-size** command, and by default is 5 ping responses. Within the sample size, the number of failed pings that means that the device is down is set by the **fail-count** command. By default this is set to 5. Once a polling instance has determined that a device is unreachable, it must receive a set number of consecutive replies before it changes the device's status back to reachable. This number is configured with the **up-count** command.

The following figure illustrates a polling instance where the device becomes unreachable, then reachable. It uses this configuration:

```
awplus(config-ping-poll)#fail-count 4
awplus(config-ping-poll)#sample-size 5
awplus(config-ping-poll)#up-count 3
awplus(config-ping-poll)#critical-interval 1
awplus(config-ping-poll)#normal-interval 30
```

Figure 88-1: Interaction between states and parameters for ping polling

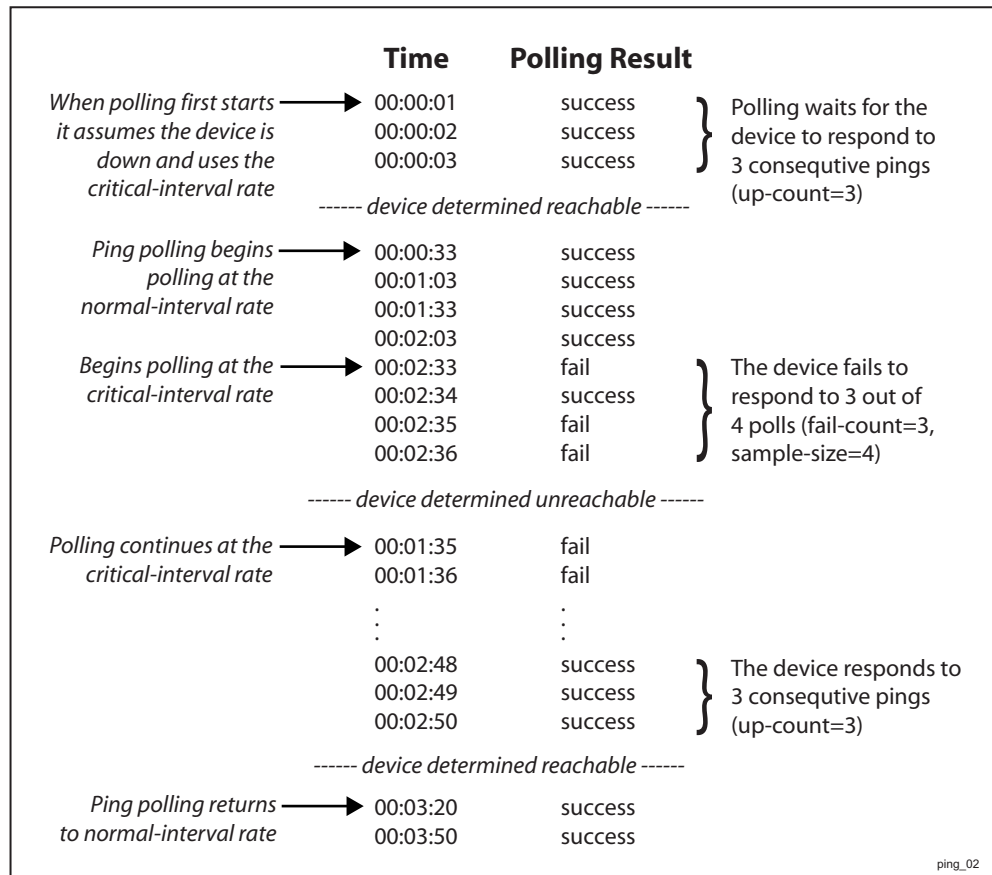

On some operating systems, some servers may respond to a ping even if no other functionality is available, and therefore remain in an Up state while malfunctioning.

Responding to status changes

To configuring your device to determine and respond to changes in a device's reachability, you will need to:

- create a polling instance to periodically ping the device
- create scripts to run when the device becomes unreachable and when it becomes reachable again
- configure triggers to run these scripts

To set a trigger to activate when a device's status changes, its trigger type must be **ping-poll**. This is with the following command in the trigger's configuration mode:

```
awplus(config-trigger)#type ping-poll <1-100> {up|down}
```

where **up** activates the trigger when the device is reachable, and **down** activates the trigger when the device is unreachable.

If you use triggers to open a backup link to a remote device in the event of the primary link failing (rather than the remote device failing), the backup link and primary link must point to different IP addresses on the remote device. Otherwise, when the backup link points to the IP address that your device is polling, your device receives ping replies through the backup link, considers the device to be reachable again, and attempts to reopen the primary link instead of using the backup link.

See [Chapter 85, Triggers Introduction](#) for more information about configuring Triggers with Ping Polling.

Configuring Ping Polling

This section contains:

- [Creating a Polling Instance](#)
This explains how to quickly create a polling instance using the ping polling defaults.
- [Customizing a Polling Instance](#)
This explains how to customize a ping poll and explains the other ping poll commands.
- [Troubleshooting Ping Polling](#)
This explains how to use the debugging and monitoring commands for ping polling.

Creating a Polling Instance

The Ping Polling feature in the AlliedWare Plus™ OS allows you to easily configure polling instances with a minimum of commands. To configure a ping poll suitable for most network situations:

1. Create a polling instance by using the command:

```
awplus(config)#ping-poll <1-100>
```

The range <1-100> identifies the polling instance in the trigger commands and in other ping poll commands. Your device can poll up to 100 IP addresses at once.

2. Set the IP address of the device you are polling by using the command:

```
awplus(config-ping-poll)#ip {<ip-address>}
```

3. Enable the polling instance by using the command:

```
awplus(config-ping-poll)#active
```

4. If desired, set an optional description to identify the polling instance, by using the command:

```
awplus(config-ping-poll)#description <description>
```

You do not need to configure any other commands for most networks, because convenient defaults exist for all other ping poll settings. The following table summarizes the default configuration created.

Command	Default
Critical-interval	1 second
Fail-count	5
Length	32 bytes
Normal-interval	30 seconds
Sample-size	5
Source-ip	The IP address of the interface from which the ping packets are transmitted

Command (cont.)	Default (cont.)
Time-out	1 second
Up-count	30

Customizing a Polling Instance

Once you've created a polling instance using the **ping-poll** and **ip (ping polling)** command, you may wish to customize the polling instance for your network.

Packet size If you find that larger packet types in your network are not reaching the polled device while smaller ones such as ping do, you can increase the data bytes included in the ping packets sent by the polling instance. This encourages the polling instance to change the device's status to unreachable when packet of the size you are interested in are being dropped. To change the number of bytes sent in the data portion of the ping packets, use the command:

```
awplus(config-ping-poll)#length <4-1500>
```

Response timeout The polling instance determines that a device hasn't responded to a ping if one second elapses without a response to the ping. In networks where ping packets have a low priority, you may need to set the allowed response time to a longer time period. To change this, use the command:

```
awplus(config-ping-poll)#time-out <1-30>
```

Polling frequency By default, a polling instance polls a reachable device every 30 seconds. You can change this by using the command:

```
awplus(config-ping-poll)#normal-interval <1-65536>
```

Once the polling instance has determined that a ping has failed, it starts polling the device at the frequency set as the critical interval—by default, one second. To change the frequency set by the critical interval, use the command:

```
awplus(config-ping-poll)#critical-interval <1-65536>
```

The critical interval enables the polling instance to quickly observe changes in the state of the device, and should be set to a much lower value than the normal interval.

Configuring when the device's status changes The number of pings that the polling instance examines to consider a change in state is controlled by the interaction of the **sample-size**, **fail-count**, and **up-count** commands. See ["How Ping Polling Works"](#) on page 88.2 for an example showing this interaction.

To determine whether a device is reachable, the polling instance counts the number of failed pings within a sample of a set size. The sample size is 5 pings by default. To change the sample size, use the command:

```
awplus(config-ping-poll)#sample-size <1-100>
```

To change the number of failed pings that the sample must have, use the command:

```
awplus(config-ping-poll)#fail-count <1-100>
```

If the sample size and fail count are the same, the unanswered pings must be consecutive. If the sample size is greater than the fail count, a device that does not always reply to pings may be declared unreachable.

The upcount is the number of consecutive pings that must be answered for the polling instance to consider the device reachable again. To change this from the default of 30, use the command:

```
awplus(config-ping-poll)#up-count <1-100>
```

Checking the configuration

To check the settings and status of the polling instance, use the command:

```
awplus(config-ping-poll)#show ping-poll [<1-100>[state {up|down}]] [brief]
```

Troubleshooting Ping Polling

To disable a polling instance, use the command:

```
awplus(config-ping-poll)#no active
```

The polling instance no longer sends ICMP echo requests to the polled device and the counters for this polling instance are reset.

To clear the counters and change the status of a device to unreachable, enter the Privileged Exec mode and use the command:

```
awplus#clear ping-poll {<1-100>|all}
```

The polling instance changes to the polling frequency specified with the **critical-interval** command. The device status changes to reachable once the device responses have reached the **up-count**.

To start debugging for ping polling, use the command:

```
awplus#debug ping-poll <1-100>
```

Interaction with Other Protocols

Ping polling does not work if the polled host, your device, or any intermediate routers or switches are configured to drop ICMP Echo Requests and Replies.

Ping and Traceroute

Ping and Traceroute are not affected by ping polling. You can enter ping and trace commands at any time and independent of the polling.

Chapter 89: Ping Polling Commands



Command List	89.2
active (ping polling)	89.2
clear ping-poll	89.3
critical-interval	89.4
debug ping-poll	89.5
description (ping polling)	89.6
fail-count	89.7
ip (ping polling)	89.8
length (ping poll data)	89.9
normal-interval	89.10
ping-poll	89.11
sample-size	89.12
show counter ping-poll	89.13
show ping-poll	89.15
source-ip	89.19
timeout (ping polling)	89.20
up-count	89.21
undebug ping-poll	89.21

Command List

This chapter provides an alphabetical reference for commands used to configure Ping Polling. For more information, see [Chapter 88, Ping Polling Introduction](#).

For information about modifying or redirecting the output from **show** commands to a file, see [“Controlling “show” Command Output” on page 1.35](#).

Table 89-1: The following table lists the default values when configuring a ping poll.

Default	Value
Critical-interval	1 second
Description	No description
Fail-count	5
Length	32 bytes
Normal-interval	30 seconds
Sample-size	5
Source-ip	The IP address of the interface from which the ping packets are transmitted
Time-out	1 second
Up-count	30

active (ping polling)

This command enables a ping poll instance. The polling instance sends ICMP echo requests to the device with the IP address specified by the **ip (ping polling)** command.

By default, polling instances are disabled. When a polling instance is enabled, it assumes that the device it is polling is unreachable.

The **no** variant of this command disables a ping poll instance. The polling instance no longer sends ICMP echo requests to the polled device. This also resets all counters for this polling instance.

Syntax active
no active

Mode Ping Polling Configuration

Examples To activate the ping poll 43, use the commands:

```
awplus(config)#ping-poll 43
awplus(config-ping-poll)#active
```

To disable the ping poll and reset its counters, use the command:

```
awplus(config-ping-poll)#no active
```

Related Commands [debug ping-poll](#)
[ip \(ping polling\)](#)
[ping-poll](#)
[show ping-poll](#)

clear ping-poll

This command resets the specified ping poll, or all ping poll instances. This clears the ping counters, and changes the status of polled devices to unreachable. The polling instance changes to the polling frequency specified with the [critical-interval](#) command. The device status changes to reachable once the device responses have reached the [up-count](#).

Syntax `clear ping-poll {<1-100>|all}`

Parameter	Description
<1-100>	A ping poll ID number. The specified ping poll instance has its counters cleared, and the status of the device it polls is changed to unreachable.
all	Clears the counters and changes the device status of all polling instances.

Mode Privileged Exec

Examples To reset the ping poll 12, use the command:

```
awplus#clear ping-poll 12
```

To reset all ping polls, use the command:

```
awplus#clear ping-poll all
```

Related Commands [active \(ping polling\)](#)
[ping-poll](#)
[show ping-poll](#)

critical-interval

This command specifies the time period in seconds between pings when the polling instance has not received a reply to at least one ping, and when the device is unreachable.

This command enables the device to quickly observe changes in state, and should be set to a much lower value than the [normal-interval](#) command.

The **no** variant of this command sets the critical interval to the default of one second.

Syntax `critical-interval <1-65536>`
`no critical-interval`

Parameter	Description
<code><1-65536></code>	Time in seconds between pings, when the device has failed to a ping, or the device is unreachable.

Default The default is 1 second.

Mode Ping Polling Configuration

Examples To set the critical interval to 2 seconds for the polling instance 99, use the commands:

```
awplus(config)#ping-poll 99
awplus(config-ping-poll)#critical-interval 2
```

To reset the critical interval to the default of one second, use the command:

```
awplus(config-ping-poll)#no critical-interval
```

Related Commands [fail-count](#)
[normal-interval](#)
[sample-size](#)
[show ping-poll](#)
[timeout \(ping polling\)](#)
[up-count](#)

debug ping-poll

This command enables ping poll debugging for the specified ping poll. This generates detailed messages about ping execution.

The **no** variant of this command disables ping poll debugging for the specified ping poll.

Syntax `debug ping-poll <1-100>`
`no debug ping-poll <1-100>`

Parameter	Description
<1-100>	A unique ping poll ID number.

Mode Privileged Exec

Examples To enable debugging for ping poll 88, use the command:

```
awplus#debug ping-poll 88
```

To disable debugging for ping poll 88, use the command:

```
awplus#no debug ping-poll 88
```

Related Commands [active \(ping polling\)](#)
[clear ping-poll](#)
[ping-poll](#)
[show ping-poll](#)
[undebug ping-poll](#)

description (ping polling)

This command specifies a string to describe the polling instance. This allows the polling instance to be recognized easily in show commands. Setting this command is optional.

By default ping polls do not have a description.

Use the **no** variant of this command to delete the description set.

Syntax `description <description>`
`no description`

Parameter	Description
<code><description></code>	The description of the target. Valid characters are any printable character and spaces. There is no maximum character length.

Mode Ping Polling Configuration

Examples To add the text "Primary Gateway" to describe the ping poll 45, use the commands:

```
awplus(config)#ping-poll 45
awplus(config-ping-poll)#description Primary Gateway
```

To delete the description set for the ping poll, use the command:

```
awplus(config-ping-poll)#no description
```

Related Commands [ping-poll](#)
[show ping-poll](#)

fail-count

This command specifies the number of pings that must be unanswered, within the total number of pings specified by the `sample-size` command, for the polling instance to consider the device unreachable.

If the number set by the `sample-size` command and the `fail-count` commands are the same, then the unanswered pings must be consecutive. If the number set by the `sample-size` command is greater than the number set by the `fail-count` command, then a device that does not always reply to pings may be declared unreachable.

The `no` variant of this command resets the fail count to the default.

Syntax `fail-count <1-100>`

`no fail-count`

Parameter	Description
<code><1-100></code>	The number of pings within the sample size that a reachable device must fail to respond to before it is classified as unreachable.

Default The default is 5.

Mode Ping Polling Configuration

Examples To specify the number of pings that must fail within the sample size to determine that a device is unreachable, use the command:

```
awplus(config-ping-poll)#fail-count 5
```

To reset the fail-count to its default value of 5, use the command:

```
awplus(config-ping-poll)#no fail-count
```

Related Commands

- `critical-interval`
- `normal-interval`
- `ping-poll`
- `sample-size`
- `show ping-poll`
- `timeout (ping polling)`
- `up-count`

ip (ping polling)

This command specifies the IPv4 address of the device you are polling.

Syntax `ip {<ip-address>}`

Parameter	Description
<code><ip-address></code>	An IPv4 address in dotted decimal notation.

Mode Ping Polling Configuration

Example To set ping poll 5 to poll the device with the IP address "192.168.0.1", use the command:

```
awplus(config)#ping-poll 5
awplus(config-ping-poll)#ip 192.168.0.1
```

Related Commands `ping-poll`
`source-ip`
`show ping-poll`

length (ping poll data)

This command specifies the number of data bytes to include in the data portion of the ping packet. This allows you to set the ping packets to a larger size if you find that larger packet types in your network are not reaching the polled device, while smaller packets are getting through. This encourages the polling instance to change the device's status to unreachable when the network is dropping packets of the size you are interested in.

The **no** variant of this command resets the data bytes to the default of 32 bytes.

Syntax `length <4-1500>`

`no length`

Parameter	Description
<code><4-1500></code>	The number of data bytes to include in the data portion of the ping packet.

Default The default is 32.

Mode Ping Polling Configuration

Examples To specify that the ping poll 12 sends ping packet with a data portion of 56 bytes, use the command:

```
awplus(config)#ping poll 12
```

```
awplus(config-ping-poll)#length 56
```

To reset the number of data bytes in the ping packet to the default value of 32 bytes, use the command:

```
awplus(config-ping-poll)#no length
```

Related Commands `ping-poll`
`show ping-poll`

normal-interval

This command specifies the time period between pings when the device is reachable.

The **no** variant of this command resets the time period to the default value of 30 seconds.

Syntax `normal-interval <1-65536>`
`no normal-interval`

Parameter	Description
<code><1-65536></code>	Time in seconds between pings when the target is reachable.

Default The default is 30 seconds.

Mode Ping Polling Configuration

Examples To specify a time period of 60 seconds between pings when the device is reachable, use the command:

```
awplus(config-ping-poll)#normal-interval 60
```

To reset the interval to the default value of 30 seconds, use the command:

```
awplus(config-ping-poll)#no normal-interval
```

Related Commands

- [critical-interval](#)
- [fail-count](#)
- [ping-poll](#)
- [sample-size](#)
- [show ping-poll](#)
- [timeout \(ping polling\)](#)
- [up-count](#)

ping-poll

This command enters the ping poll configuration mode. If a ping poll exists with the specified number, then this command enters its configuration mode. If no ping poll exists with the specified number, then this command creates a new ping poll with this ID number.

To configure a ping poll, create a ping poll using this command, and use the [ip \(ping polling\)](#) command to specify the device you want the polling instance to poll. It is not necessary to specify any further commands unless you want to change a command's default.

The **no** variant of this command deletes the specified ping poll.

Syntax `ping-poll <1-100>`
`no ping-poll <1-100>`

Parameter	Description
<code><1-100></code>	A unique ping poll ID number.

Mode Global Configuration

Examples To create ping poll 3 and enter its configuration mode, use the command:

```
awplus(config)#ping-poll 3
```

To delete ping poll 3, use the command:

```
awplus(config)#no ping-poll 3
```

Related Commands

- [active \(ping polling\)](#)
- [clear ping-poll](#)
- [debug ping-poll](#)
- [description \(ping polling\)](#)
- [ip \(ping polling\)](#)
- [length \(ping poll data\)](#)
- [show ping-poll](#)
- [source-ip](#)

sample-size

This command sets the total number of pings that the polling instance inspects when determining whether a device is unreachable. If the number of pings specified by the **fail-count** command go unanswered within the inspected sample, then the device is declared unreachable.

If the numbers set in this command and **fail-count** command are the same, the unanswered pings must be consecutive. If the number set by this command is greater than that set with the **fail-count** command, a device that does not always reply to pings may be declared unreachable.

You cannot set this command's value lower than the **fail-count** value.

The polling instance uses the number of pings specified by the **up-count** command to determine when a device is reachable.

The **no** variant of this command resets this command to the default value.

Syntax `sample-size <1-100>`

`no sample size`

Parameter	Description
<code><1-100></code>	Number of pings that determines critical and up counts.

Default The default is 5.

Mode Ping Polling Configuration

Examples To set the sample-size to 50, use the command:

```
awplus(config-ping-poll)#sample-size 50
```

To reset sample-size to the default of 5, use the command:

```
awplus(config-ping-poll)#no sample-size
```

Related Commands

- [critical-interval](#)
- [fail-count](#)
- [normal-interval](#)
- [ping-poll](#)
- [show ping-poll](#)
- [timeout \(ping polling\)](#)
- [up-count](#)

show counter ping-poll

This command displays the counters for ping polling.

Syntax `show counter ping-poll [<1-100>]`

Parameter	Description
<1-100>	A unique ping poll ID number. This displays the counters for the specified ping poll only. If you do not specify a ping poll, then this command displays counters for all ping polls.

Mode User Exec and Privileged Exec

Output Figure 89-1: Example output from the `show counter ping-poll` command

```

Ping-polling counters
Ping-poll: 1
PingsSent                ..... 15
PingsFailedUpState      ..... 0
PingsFailedDownState    ..... 0
ErrorSendingPing        ..... 2
CurrentUpCount          ..... 13
CurrentFailCount        ..... 0
UpStateEntered          ..... 0
DownStateEntered        ..... 0

Ping-poll: 2
PingsSent                ..... 15
PingsFailedUpState      ..... 0
PingsFailedDownState    ..... 0
ErrorSendingPing        ..... 2
CurrentUpCount          ..... 13
CurrentFailCount        ..... 0
UpStateEntered          ..... 0
DownStateEntered        ..... 0

Ping-poll: 5
PingsSent                ..... 13
PingsFailedUpState      ..... 0
PingsFailedDownState    ..... 2
ErrorSendingPing        ..... 2
CurrentUpCount          ..... 9
CurrentFailCount        ..... 0
UpStateEntered          ..... 0
DownStateEntered        ..... 0
    
```

Table 89-2: Parameters in output of the `show counter ping-poll` command

Parameter	Description
Ping-poll	The ID number of the polling instance.
PingsSent	The total number of pings generated by the polling instance.
PingsFailedUpState	The number of unanswered pings while the target device is in the Up state. This is a cumulative counter for multiple occurrences of the Up state.
PingsFailedDownState	Number of unanswered pings while the target device is in the Down state. This is a cumulative counter for multiple occurrences of the Down state.

Table 89-2: Parameters in output of the **show counter ping-poll** command

Parameter	Description
ErrorSendingPing	The number of pings that were not successfully sent to the target device. This error can occur when your device does not have a route to the destination.
CurrentUpCount	The current number of sequential ping replies.
CurrentFailCount	The number of ping requests that have not received a ping reply in the current sample-size window.
UpStateEntered	Number of times the target device has entered the Up state.
DownStateEntered	Number of times the target device has entered the Down state.

Example To display counters for the polling instances, use the command:

```
awplus#show counter ping-poll
```

Related Commands [debug ping-poll](#)
[ping-poll](#)
[show ping-poll](#)

show ping-poll

This command displays the settings and status of ping polls.

Syntax `show ping-poll [<1-100>|state {up|down}] [brief]`

Parameter	Description
<1-100>	Displays settings and status for the specified polling instance.
state	Displays polling instances based on whether the device they are polling is currently reachable or unreachable.
up	Displays polling instance where the device state is reachable.
down	Displays polling instances where the device state is unreachable.
brief	Displays a summary of the state of ping polls, and the devices they are polling.

Mode User Exec and Privileged Exec

Output Figure 89-2: Example output from the `show ping-poll brief` command

```

Ping Poll Configuration
-----
Id Enabled State Destination
-----
1  Yes      Down  192.168.0.1
2  Yes      Up    192.168.0.100
    
```

Table 89-3: Parameters in output of the `show ping-poll brief` command

Parameter	Meaning
Id	The ID number of the polling instance, set when creating the polling instance with the <code>ping-poll</code> command.
Enabled	Whether the polling instance is enabled or disabled.

Parameter	Meaning	
State	The current status of the device being polled:	
	Up	The device is reachable.
	Down	The device is unreachable.
	Critical Up	The device is reachable but recently the polling instance has not received some ping replies, so the polled device may be going down.
	Critical Down	The device is unreachable but the polling instance received a reply to the last ping packet, so the polled device may be coming back up.
Destination	The IP address of the polled device, set with the <code>ip (ping polling)</code> command.	

Figure 89-3: Example output from the **show ping-poll** command

```

Ping Poll Configuration
-----

Poll 1:
Description                : Primary Gateway
Destination IP address     : 192.168.0.1
Status                     : Down
Enabled                    : Yes
Source IP address         : 192.168.0.10
Critical interval         : 1
Normal interval           : 30
Fail count                 : 10
Up count                   : 5
Sample size                : 50
Length                    : 32
Timeout                   : 1
Debugging                  : Enabled

Poll 2:
Description                : Secondary Gateway
Destination IP address     : 192.168.0.100
Status                     : Up
Enabled                    : Yes
Source IP address         : Default
Critical interval         : 5
Normal interval           : 60
Fail count                 : 20
Up count                   : 30
Sample size                : 100
Length                    : 56
Timeout                   : 2
Debugging                  : Enabled
    
```

 Table 89-4: Parameters in output of the **show ping-poll** command

Parameter	Description								
Description	Optional description set for the polling instance with the description (ping polling) command.								
Destination IP address	The IP address of the polled device, set with the ip (ping polling) command.								
Status	The current status of the device being polled: <table border="1" data-bbox="678 1518 1426 1865"> <tbody> <tr> <td>Up</td> <td>The device is reachable.</td> </tr> <tr> <td>Down</td> <td>The device is unreachable.</td> </tr> <tr> <td>Critical Up</td> <td>The device is reachable but recently the polling instance has not received some ping replies, so the polled device may be going down.</td> </tr> <tr> <td>Critical Down</td> <td>The device is unreachable but the polling instance received a reply to the last ping packet, so the polled device may be coming back up.</td> </tr> </tbody> </table>	Up	The device is reachable.	Down	The device is unreachable.	Critical Up	The device is reachable but recently the polling instance has not received some ping replies, so the polled device may be going down.	Critical Down	The device is unreachable but the polling instance received a reply to the last ping packet, so the polled device may be coming back up.
Up	The device is reachable.								
Down	The device is unreachable.								
Critical Up	The device is reachable but recently the polling instance has not received some ping replies, so the polled device may be going down.								
Critical Down	The device is unreachable but the polling instance received a reply to the last ping packet, so the polled device may be coming back up.								
Enabled	Whether the polling instance is enabled or disabled. The active (ping polling) and no active commands enable and disable a polling instance.								

Table 89-4: Parameters in output of the **show ping-poll** command (cont.)

Parameter	Description
Source IP address	The source IP address sent in the ping packets. This is set using the source-ip command.
Critical interval	The time period in seconds between pings when the polling instance has not received a reply to at least one ping, and when the device is unreachable. This is set with the critical-interval command.
Normal interval	The time period between pings when the device is reachable. This is set with the normal-interval command.
Fail count	The number of pings that must be unanswered, within the total number of pings specified by the sample-size command, for the polling instance to consider the device unreachable. This is set using the fail-count command.
Up count	The number of consecutive pings that the polling instance must receive a reply to before classifying the device reachable again. This is set using the up-count command.
Sample size	The total number of pings that the polling instance inspects when determining whether a device is unreachable. This is set using the sample-size command.
Length	The number of data bytes to include in the data portion of the ping packet. This is set using the length (ping poll data) command.
Timeout	The time in seconds that the polling instance waits for a response to a ping packet. This is set using the timeout (ping polling) command.
Debugging	Indicates whether ping polling debugging is Enabled or Disabled . This is set using the debug ping-poll command.

Examples To display the ping poll settings and the status of all the polls, use the command:

```
awplus#show ping-poll
```

To display a summary of the ping poll settings, use the command:

```
awplus#show ping-poll brief
```

To display the settings for ping poll 6, use the command:

```
awplus#show ping-poll 6
```

To display a summary of the state of ping poll 6, use the command:

```
awplus#show ping-poll 6 brief
```

To display the settings of ping polls that have reachable devices, use the command:

```
awplus#show ping-poll state up
```

To display a summary of ping polls that have unreachable devices, use the command:

```
awplus#show ping-poll 6 state down brief
```

Related Commands [debug ping-poll](#)
[ping-poll](#)

source-ip

This command specifies the source IP address to use in ping packets.

By default, the polling instance uses the address of the interface through which it transmits the ping packets. It uses the device's local interface IP address when it is set. Otherwise, the IP address of the interface through which it transmits the ping packets is used.

The **no** variant of this command resets the source IP in the packets to the device's local interface IP address.

Syntax `source-ip {<ip-address>}`

`no source-ip`

Parameter	Description
<code><ip-address></code>	An IPv4 address in dotted decimal notation.

Mode Ping Polling Configuration

Examples To configure the polling instance to use the source IP address 192.168.0.1 in ping packets, use the command:

```
awplus(config-ping-poll)#source-ip 192.168.0.1
```

To reset the source IP address to the device's local interface IP address, use the command:

```
awplus(config-ping-poll)#no source-ip
```

Related Commands

- [description \(ping polling\)](#)
- [ip \(ping polling\)](#)
- [length \(ping poll data\)](#)
- [ping-poll](#)
- [show ping-poll](#)

timeout (ping polling)

This command specifies the time in seconds that the polling instance waits for a response to a ping packet. You may find a higher time-out useful in networks where ping packets have a low priority.

The **no** variant of this command resets the set time out to the default of one second.

Syntax `time-out <1-30>`

`no time-out`

Parameter	Description
<code><1-30></code>	Length of time, in seconds, that the polling instance waits for a response from the polled device.

Default The default is 1 second.

Mode Ping Polling Configuration

Examples To specify the time-out as 5 seconds, use the command:

```
awplus(config-ping-poll)#timeout 5
```

To reset the time-out to its default of 1 second, use the command:

```
awplus(config-ping-poll)#no timeout
```

Related Commands

- [critical-interval](#)
- [fail-count](#)
- [normal-interval](#)
- [ping-poll](#)
- [sample-size](#)
- [show ping-poll](#)
- [up-count](#)

up-count

This command sets the number of consecutive pings that the polling instance must receive a reply to before classifying the device reachable again.

The **no** variant of this command resets the up count to the default of 30.

Syntax `up-count <1-100>`

`no up-count`

Parameter	Description
<code><1-100></code>	Number of replied pings before an unreachable device is classified as reachable.

Default The default is 30.

Mode Ping Polling Configuration

Examples To set the upcount to 5 consecutive pings, use the command:

```
awplus(config-ping-poll)#up-count 5
```

To reset the upcount to the default value of 30 consecutive pings, use the command:

```
awplus(config-ping-poll)#no up-count
```

Related Commands

- [critical-interval](#)
- [fail-count](#)
- [normal-interval](#)
- [ping-poll](#)
- [sample-size](#)
- [show ping-poll](#)
- [timeout \(ping polling\)](#)

undebg ping-poll

This command applies the functionality of the [no debug ping-poll command on page 89.5](#).

Chapter 90: sFlow Introduction



sFlow Introduction.....	90.2
The sFlow Agent.....	90.3
Sampling Methods.....	90.3
The sFlow Collector.....	90.5
Configuring sFlow on your Switch.....	90.6
Configuration Procedure.....	90.7
Configuration Examples.....	90.8
sFlow Datagrams.....	90.14
The sFlow MIB.....	90.16

sFlow Introduction

sFlow^{®1} provides the ability to monitor traffic in data networks containing switches and routers. A network employing sFlow typically comprises a number of network (sFlow) agents that accumulate sampled data and traffic counter information. The agents then forward this data to a collector. The collector then analyses the information supplied by its agents in order to compile and display statistical profiles of the network and its traffic. The sFlow feature on your switch provides the sFlow Agent capability.

1. sFlow[®] is a registered trademark belonging to InMon Corp, San Francisco, CA.

Figure 90-1 on page 90.2 shows a basic sFlow network structure. The three network switches also function as sFlow agents. Each agent switch captures samples of the traffic passing through its monitored ports, and sends these samples together with counter information back to the sFlow collector. The agents sample data from a number of switch ports, each acting as an sFlow data source.

Figure 90-1: Basic sFlow Network

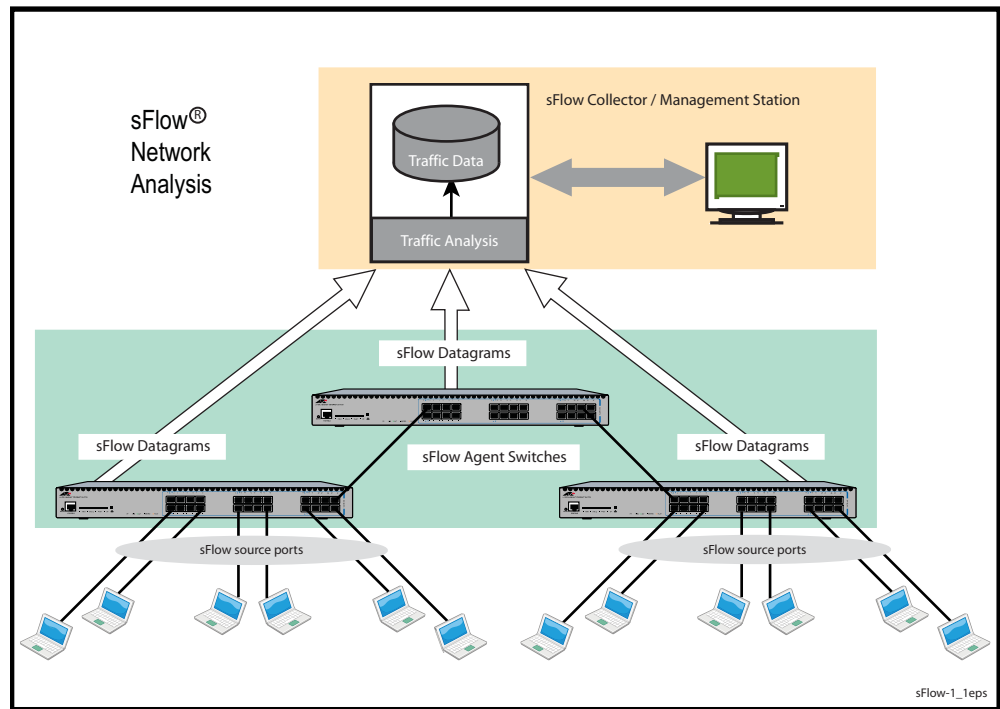

The sFlow Agent

Your switch can act as an sFlow agent. The key capabilities of the agent are to:

- sample frames as they pass through selected ports on the switch, and provide sampled extracts of the network traffic.
- periodically capture interface counter data.
- package together the sampled frame and counter information that can be sent to the collector for analysis and display.
- be configurable via SNMP MIB objects.
- communicate to heterogeneous collector devices by means of standard protocols.

Agent components and functionality

sFlow functionality on your switch is based on the requirements defined in of RFC 3176 and its updates defined in the sFlow version 5 memo dated July 2004. This memo can be found at the web site, www.sflow.org/sflow_version_5.txt.

The terms defined in [Table 90-1](#) are used to describe the agent and its functionality on your switch:

Table 90-1: sFlow Terminology

sFlow® Component	Definition
Network Device	Typically either a network switch or router that has the ability to forward frames across an Ethernet network; or between Ethernet networks, in the case of a router.
Data Source (sFlow Source Port)	The location of a sampling point within the switch. This is typically a switch port.
Packet Flow	The path taken by the data (frames) as they traverse a network device.
Sampling Rate	The ratio of frames passing through the data source, to those captured and forwarded as sFlow data. See sflow sampling-rate command on page 91.11 .
Counter Sampling	The periodic polling of counters taken at the data source.
sFlow Datagram	A UDP datagram that contains details of sFlow captured data, and counters sent by the sFlow Agent to its Collector.

The sFlow agent (switch) uses sampling technology to derive traffic statistics from its monitored ports. Samples are taken at the sFlow source ports. After collecting its information, the switch then packetizes its samples and statistical data, and sends both to a remote sFlow collector.

Sampling Methods

Two sampling methods are employed within the sFlow agent, frame sampling, and counter sampling. Both sample types are combined within the datagrams sent to the collector. The frame sample data will result in a relatively constant traffic stream, but the counter information is sent where it can fill available space within each datagram. Datagrams are normally sent to the collector at the rate of one each second. However, several datagrams can be sent in rapid succession, where more information exists than can be sent in a single datagram.

Frame Sampling

As frames enter or leave an sFlow source port, they are sampled at a rate determined by the [sflow sampling-rate command on page 91.11](#) for that particular port.

Sampling occurs every N frames (on average), where N is the rate value set via [sflow sampling-rate](#) command. The sampling rate applies to ingress and egress frames independently. For example, a value of 1000, will sample one frame in every 1000 frames received, one in every 1000 frames sent from the specified port.

Caution  Setting the sFlow sampling rate to a very low value (frequent sampling) can place a heavy load on the switch's CPU. The severity of this loading will increase with the number of ports configured for sampling, the port speeds, and their data sampling rates.

Data Confidentiality

Sampling operates by capturing the initial portion of frames (statistically) selected. The portion sampled is set by the [sflow max-header-size command on page 91.8](#), or SNMP. If the **maximum header size** is greater than the actual headers in the sampled frames, then portions of the user data (payload) will also be captured and encapsulated in the datagrams sent to the collector. The amount of user data captured can be minimized by careful selection of the maximum header size.

Counter Polling

The function of counter polling is to provide snapshots of various system counters. This produces a series of data counter sets for each port, which can be independently polled at defined rates, and periodically sent to the collector. Currently Allied Telesis switches support only generic interface counters. For more information on the data types included in the sampling count, see [“sFlow Datagrams” on page 90.14](#).

Periodically, say every second, the sFlow Agent examines the list of counter sources and sends any counters that need to be sent at the rate defined by the [sflow polling-interval](#).

The sFlow Collector

The sFlow collector receives traffic samples and counter information from a number of sFlow agents. These samples are received as a series of UDP datagrams. From the data contained within these datagrams, the collector is able to provide statistical and or graphical information of network traffic.

The sFlow agent application on your switch supports only a single collector configuration.

sFlow collectors are proprietary third party products, Although your switch has been designed and tested for interoperability with the inMon sFlow collector.

The sFlow Collector may also contain an SNMP Manager that is able to configure sFlow on its agent switches.

Configuring sFlow on your Switch

This section provides some guidelines for setting up the sFlow® agent on your switch. sFlow can be configured directly on your switch - using the CLI, or it can be configured via an SNMP manager. The SNMP management function can be carried out either by a the sFlow collector, or a separate SNMP manager. The configuration examples in this section are shown using the CLI.

Caution



On an x908 with a XEM-2XP module fitted, sFlow sampling does not operate for this XEM when the XEM-2XP is installed in the lowest numbered x908 bay. Ensure that any XEM-2XP modules are not fitted in the lowest bay in an x908.

If a XEM module that is installed in a lower numbered x908 bay is hot swapped then a XEM-2XP module installed in a higher numbered x908 bay may become the XEM in the lowest numbered bay, resulting in sFlow sampling not operating. Ensure that any XEM-2XP modules will not become the XEM in the lowest numbered bay in an x908 by fitting the XEM-2XP in the highest numbered bay.

Caution



The sFlow configurations set either by the switch's CLI, or the sFlow collector. Sometimes the collector will override the sFlow settings that were initially configured by the CLI, in order to apply "its" own default settings.

If you want to apply the sFlow settings set by the CLI, or by an external network management system, then turn off network management at the collector.

We also advise that as part of your sFlow commissioning process, you review your security access procedures relating to sFlow access and its data traffic management.

sFlow configuration can vary greatly with your overall configuration, data profile, and monitoring intensity. Also, many interdependencies existing between parameter settings. For this reason, few firm configuration settings are recommended in this software reference, but instead these parameter relationships are explained and some typical configuration examples are shown.

The default settings on your switch have sFlow turned off for all ports.

The following commands are used to setup and configure sFlow on your switch. These are introduced in the order in which you would logically need to use them.

sFlow Command	Functionality
<code>sflow enable</code>	enables sFlow on your switch (or stack)
<code>sflow max-header-size</code>	sets the maximum sFlow data capture size
<code>sflow collector max-datagram-size</code>	sets the maximum size for the agent to collector datagrams
<code>sflow agent (address)</code>	sets the sFlow agent IP address on the switch
<code>sflow polling-interval</code>	sets the counter polling interval for specified ports
<code>sflow sampling-rate</code>	sets the mean sampling rate for specified ports
<code>sflow collector (address)</code>	the sFlow agent's collector IP address and/or UDP port

Configuration Procedure

The following process sets out a systematic procedure to configure sFlow on your switch:

Information Gathering

sFlow configuration is dependant on your network structure and its data. Start by gathering together the following information.

- Obtain (or determine) the sFlow collector IP address.
- Select an appropriate UDP port for your sFlow datagrams. The recommended value is 6343, and is the default value preconfigured on your switch.
- Select an appropriate IP address for your sFlow agent. We recommend that you use the local IP address of your switch. For more information on local addresses and how to set them up, see the [interface \(to configure\) command on page 12.3](#).
- Assess the sensitivity of the data that your sFlow agent will be sampling.
- Obtain details of the protocols that your sFlow agent will be sampling. If you intend sampling unusual or proprietary protocols, obtain details of their header lengths.
- Calculate the most appropriate max-header-size for your sFlow sampling.
- Select the ports that you want to sample, and their sample rate. These two factors vary (not quite) proportionally; so if you double the number of ports and double your sampling rate (i.e. sample half as many frames) then you will “almost” return to your earlier situation. Also note the speeds of the ports you have selected, because - for the same port utilization - the faster the port speed, the greater the load on the CPU.
- Review the speed of the port used to transport the sFlow datagrams to the collector. Unless configured to a specific port, the collector traffic will share the same network port with other traffic.

The capacity of the collector port should be sufficient to carry the volume of sFlow traffic. This topic is expanded on in the [Configuration Examples](#) later in this chapter.

Managing the sFlow processing overhead

The sFlow data sampled on the ports converges into the CPU for processing and UDP packetizing. Therefore one of the major factors when configuring sFlow is to prevent the sFlow data volumes from placing a significant overhead on the CPU processing. The two most significant factors here are, the **number of ports sampled**, and the **sampling rate**. The other (and lesser) factors in this equation are the **frame size distribution** and the **maximum header size**. The shorter the frames are on the network, the heavier the sFlow processing load will be (for the same number of frames per second). Conversely the shorter the maximum header size selected, the lighter the sFlow processing load will be (because less data per frame is sent to the CPU).

Configuration Examples

This section provides a configuration example based on the network shown below:

Figure 90-2: sFlow Configuration Example

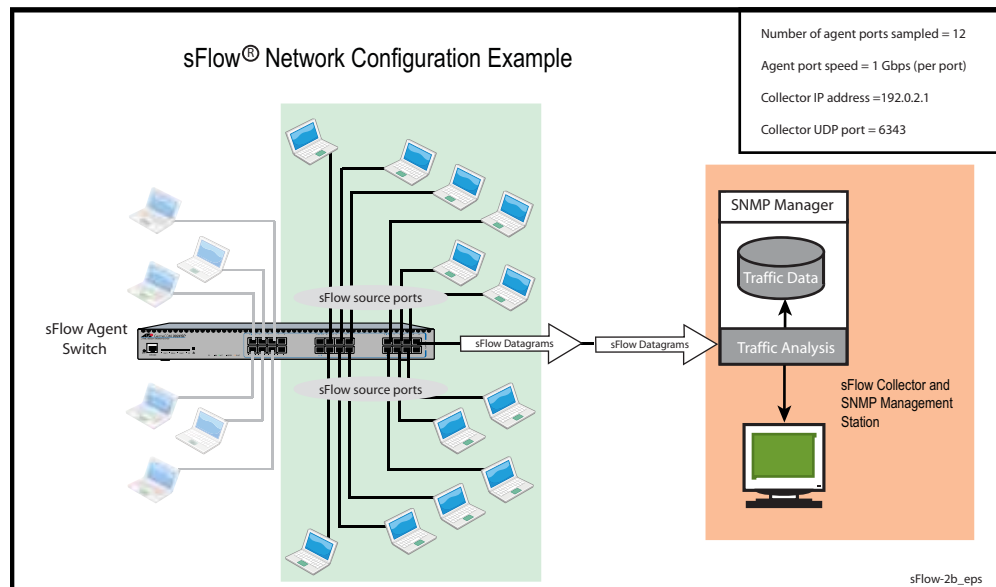

Step 1: Determine the IP addresses and UDP ports.

Collector IP address is 192.0.2.65

sFlow UDP port uses the default of 6343

Agent (local) IP address 192.0.2.33. This is the address that the collector may use to configure the agent via SNMP.

Step 2: Determine the maximum sFlow Datagram size.

Datagrams will be sent at one second intervals regardless of the amount of data they contain. If the amount of data to be sent is greater than the maximum datagram size, then several datagrams will be sent in quick succession - within the 1 second interval. The objective is to contain the sFlow information in a the minimum number of datagrams. That is, to fragment datagrams when necessary, but do it as little as possible.

Find the maximum datagram size that will pass through all network components without fragmenting. Then set the sFlow datagram size a little less than this value.

The maximum datagram size should be less than the MTU size.

For this example, the MTU is assumed to be set to its default of 1500 bytes. In this situation we could leave the maximum Datagram size at its default of 1400 bytes; but in order to show this as a configuration step, we will change it to 1200 bytes.

Note  sFlow datagrams are generally transmitted at 1 second intervals. However, where there is more information than can fit into one datagram, several datagrams are sent sequentially, within the 1 second time frame.

Step 3: Determine the max-header-size for the sampled data.

The maximum header size for the sampled data is set by the `sflow max-header-size` command. The optimum setting is to capture only the header portion of the frame and discard the user-data portion. This is especially important where the user data contains sensitive information.

Keeping the max-header-size as small as possible has the additional benefit of lightening the CPU load.

First, inspect the nature of the data to be sampled and the protocols used to carry it. For this example we will assume that the network contains Ethernet II frames with the 4 byte 802.1Q header component, IP, TCP protocols. In this situation the following rules can be applied:

For an environment using standard TCP/IPv4 over Ethernet frames, consider the following protocol basics.

Ethernet header (including the 4 byte 802.1Q header component) = 18 bytes

IPv4 header = 24 bytes

TCP header = 24 bytes

Total = 66 bytes

A similar calculation can be made for an environment using IPv6 over Ethernet.

Ethernet header (including the 4 byte 802.1Q component) = 18 bytes

IPv6 header = 40 bytes

TCP header = 24 bytes

Total = 82 bytes

Caution In the above network scenarios:



- For IPv4 - any data existing between 66 bytes and the value set by this command will be included in the sFlow packet samples. For example, with the default of 128 applied, up to $128-66=62$ bytes of user data could be included in the sFlow datagram samples sent between the Agent and the Collector.
 - For IPv6 - any data existing between 82 bytes and the value set by this command will be included in the sFlow packet samples. For example, with the default of 128 applied, up to $128-82=46$ bytes of user data could be included in the sFlow datagram samples sent between the Agent and the Collector.
-

For this example the `sflow max-header-size` will be set to 68 bytes (assuming an Ethernet - IPv4 - TCP environment).

Step 4: Select ports to sample

Each sampled sFlow port speed is 1 Gbps

12 ports have been selected for sampling
 Check that none of the ports selected have mirroring configured. sFlow will not operate on a port configured for mirroring.

Note  When sampling is across ports that form an aggregated link, statistics will be extracted on traffic across all links, but their display is shown as if all traffic is flowing through the first physical link created.

Step 5: Determine the sampling rate

Selecting the sampling rate involves a trade-off between sFlow requirements, and system loading. The greater the sampling rate, the more samples will be taken, and the more accurate their results will be. Unfortunately, taking more samples increases the load on the switch CPU and on the network connection to the collector.

The of N was chosen (512) so as to present a light load on the CPU, in this particular configuration.

Step 6: Review and adjust settings

Because sFlow traffic loading will vary with the traffic profile, the following general assumptions are made. The following traffic profile are assumed.

- « 50 % of frames are <200 bytes long
- « 40 % of frames are >1400 bytes long

The following settings are:

- « 12 x 1 Gbps ports are being sampled
- « sFlow max-header size = 68 bytes
- « sampling rate (N = 512)
- « average port utilization is assumed to be approximately 60 %
- « average data rate to the collector assumed to be approximately 1.5 Mbps

When setting the sampling rate, consider the following factors that will affect the CPU load. This load will increase (not necessarily linearly) as you:

- « increase the number of ports configured
- « increase the port speeds
- « decrease the sampling rate
- « increase the max-header-size

For this configuration the average sFlow collector traffic is expected to be approximately 1.5 Mbps. In this example the agent-to-collector traffic will be shared with non sFlow traffic. Although not described in this example, you can specifically configure the collector port to route only sFlow traffic. To do this you would need to assign a separate VLAN (and IP address) to the agent-to collector interface and direct your sFlow traffic to this interface.

We advise that you ensure adequate bandwidth is provided for both the sFlow and general traffic that could share its network connection.

We will now use these settings to configure the network.

Configuration Process

The following steps apply the settings obtained in the previous section.

Step 1: Configure sFlow

Enable sFlow on the switch

```

awplus#
configure terminal  Enter Global Configuration Mode
-----
awplus(config)#
sflow enable      Enable the sFlow agent globally on the switch
-----
awplus(config)#
exit              Return to user exec mode
-----
                                validate that sFlow is enabled
-----
awplus# show running-config sflow
-----
                                !
                                sflow enable
                                !
-----

```

Step 2: Configure the sFlow Collector

Set the sFlow collector max-datagram size

```

awplus#
configure terminal  Enter Global Configuration Mode.
-----
awplus(config)#
sflow collector max- Set the maximum size of the sFlow datagrams
datagram-size 1200  to 1200 bytes.
-----

```

Set the sFlow collector (address)

```

awplus#
configure terminal  Enter Global Configuration Mode.
-----
awplus(config)#
sflow collector ip  Set the sFlow collector address to 192.0.2.65
192.0.2.65
-----

```

Step 3: Configure the sFlow Agent

Set the sFlow agent (address)

```
awplus#  
configure terminal Enter Global Configuration Mode.  
awplus(config)#  
sflow agent ip 192.0.2.33 Set the sFlow agent address to 192.0.2.33
```

Set the sFlow sampling rate on sFlow Source Ports

```
awplus#  
configure terminal Enter Global Configuration Mode.  
awplus(config)#  
interface port1.0.11-port1.0.22 Select the port range to configure (ports  
1.0.11 to 1.0.22).  
awplus(config-if)#  
sflow sampling-rate 512 Set the sampling rate on the selected ports.
```

Step 4: Check the Configuration

View the sFlow Configuration

```
awplus# sh running-config sflow
```

Figure 90-3: Output from the **show running-config sFlow** command

```
awplus#sh run sflow  
!  
sflow agent ip 192.0.2.33  
sflow collector ip 192.0.2.65  
sflow collector max-datagram-size 1200  
sflow enable  
!  
interface port1.0.11-port1.0.22  
sflow sampling-rate 512
```

sFlow Datagrams

Caution



In the above network scenarios:

- For IPv4 - any data existing between 66 bytes and the value set by this command will be included in the sFlow packet samples. For example, with the default of 128 applied, up to 128-66=62 bytes of user data could be included in the sFlow datagram samples sent between the Agent and the Collector.
- For IPv6 - any data existing between 82 bytes and the value set by this command will be included in the sFlow packet samples. For example, with the default of 128 applied, up to 128-82=46 bytes of user data could be included in the sFlow datagram samples sent between the Agent and the Collector.

After data sampling and counter information has been gathered, each sFlow agent packetizes the data and sends it to an sFlow collector where it can be analyzed and displayed in charts and tables etc.

This packetized data is sent to the collector in UDP datagrams. These datagrams bear the IP address of the collector and the port number 6343. Using a standardized port helps to avoid configuration problems between the sFlow agents and collectors.

Although an analysis of the sFlow datagrams is outside the scope of this document, some basic information is provided here for those interested in knowing the basic components of the sFlow datagrams. The full specification of the sFlow protocol can be found at www.sflow.org/sflow_version_5.txt.

sFlow datagrams comprise three basic components:

- Datagram header information
- Flow sample information - may contain several samples
- Counter statistical information - fitted in where space permits

Figure 90-4: sFlow Datagram Encapsulation

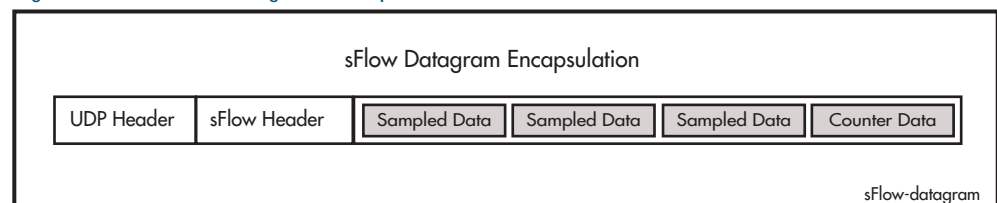

The content of these datagram components is listed below:

sFlow Header Fields

- Version (The sFlow version being used)
- IP Address Type (Can be either an IPv4 or IPv6 address type)
- Source IP Address (The IP address of the sFlow agent)
- Sequence Number (The datagram sequence number)
- System Up-time
- Sample Count (The number of samples in the datagram)
- Sample Dataset

sFlow Flow Sample Fields

- Flow Sample 1 (The first sample)
- Sample Type (Flow Sample, 0x0001)
- Sample Sequence Number (of flow samples)
- Sampler ID
- Sampling Rate (as set by the "sflow sampling-rate" on page 91.11 or SNMP)
- Sample Pool (the total number of packets that could have been sampled)

- Packets Dropped (the number of packets dropped, due to a lack of resources)
- Input (the interface that the packet was received on - not supported)
- Output (the index number of the interface that the packet was sent from)
(Note that your collector should have the ability via SNMP to resolve index numbers to physical port numbers)
- Packet Type
- Header Protocol - Ethernet ISO 88023(1)
- Packet Size (Frame Length including the FCS)
- Header Length - The sampled portion of the frame as set by the “[sflow max-header-size](#)” on page 91.8. May be shorter for small frames.
- Header Bytes
- Extended Elements Number
- Extended Elements

Note that in practice the Ethernet header is usually followed by components for the IP, TCP, and user data.

sFlow Flow Sample Fields

- Counter Sample
- Sample Type (Counter Sample, 0x0002)
- Sample Sequence Number
- Sample ID (source ID index value)
- Sample Interval (as set by the “[sflow polling-interval](#)” on page 91.10)
- Counter Type (1=generic, 2=Ethernet)

Generic Interface Counters

- ifIndex
- ifType
- ifSpeed
- ifDirection (0=unknown, 1=full-duplex, 2=half-duplex, 3=in, 4=out)
- ifStatus
- InOctets
- InUcastpackets
- InMulticast packets
- InBroadcast packets
- InDiscarded packets (= 0)
- InPackets containing errors
- InPackets containing unknown protocols (= 0)
- OutOctets
- OutUcast packets
- OutMulticast packets
- OutBroadcast packets
- OutDiscarded packets
- OutPackets containing errors
- ifPromiscuous Mode

Ethernet Interface Counters

- dot3Stats Alignment Errors (= 0)
- dot3Stats FCS Errors
- dot3Stats Single Collision Frames (= 0)
- dot3Stats Multiple Collision Frames
- dot3Stats SQE Test Errors
- dot3Stats Deferred Transmissions (= 0)
- dot3Stats Late Collisions
- dot3Stats Excessive Collisions
- dot3Stats Internal Mac Transmit Errors
- dot3Stats Carrier Sense Errors (= 0)
- dot3Stats Frame Too Longs

- dot3Stats Internal Mac Receive Errors
- dot3Stats Symbol Errors (= 0)

The sFlow MIB

Your switch fully supports inMon's sFlow MIB. For more information, see "Private MIBs" on page 79.66, and the website www.sflow.org/SFLOW-MIB5.txt.

Chapter 91: sFlow Commands



Command List	91.2
debug sflow	91.2
debug sflow agent.....	91.3
sflow agent (address).....	91.4
sflow collector (address)	91.5
sflow collector max-datagram-size.....	91.6
sflow enable	91.7
sflow max-header-size	91.8
sflow polling-interval.....	91.10
sflow sampling-rate	91.11
show debugging sflow	91.12
show running-config sflow	91.13
show sflow	91.14
show sflow interface	91.15
undebg sflow.....	91.15

Command List

This chapter provides an alphabetical reference for sFlow commands.

debug sflow

This command enables sFlow® debug message logging, for sFlow sampling and polling activity on the specified ports. If no ports are specified, sampling and/or polling debug messages are enabled for all ports.

The **no** variant of this command disables sFlow sampling and or polling debug message logging on the ports selected. If no ports are specified, sampling and/or polling debug messages are disabled on all ports.

Syntax `debug sflow [interface <ifrang>] [sampling][polling]`
`no debug sflow [interface <ifrang>] [sampling][polling]`

Parameter	Description
<code>interface</code>	Interface information.
<code><ifrang></code>	The ports for which sFlow debug is to be enabled.
<code>sampling</code>	Debug sFlow sampling for the specified port(s).
<code>polling</code>	Debug sFlow polling for the specified port(s).

Default The sFlow sampling and or polling debug is disabled.

Mode Privileged Exec

Examples To enable sFlow debug message logging for polling and sampling on `port1.0.1` and `port1.0.7`, use the commands:

```
awplus# debug sflow interface port1.0.1,port1.0.7 sampling
polling
```

To enable logging and polling of sFlow debug messages for polling and sampling on all ports, use the command:

```
awplus# debug sflow sampling polling
```

Related Commands `show debugging sflow`
`no debug all`

debug sflow agent

This command enables sFlow® debug message logging that is not specific to particular ports. For example, sending an sFlow datagram to the collector.

The **no** variant of this command applies the command default.

Syntax `debug sflow agent`

`no debug sflow agent`

Default The sFlow agent debug message logging (that is not port specific) is disabled.

Mode Privileged Exec

Example To enable logging of sFlow agent debug messages, use the following command:

```
awplus# debug sflow agent
```

Related Commands [show debugging sflow](#)
[debug sflow](#)

sflow agent (address)

This command sets the sFlow® agent IP address on the switch. This address is inserted into every sFlow datagram sent from the sFlow agent switch to the sFlow collector device. The sFlow collector can then use this address to uniquely identify and to access the switch, such as for SNMP. We therefore recommend that you change this address as little as possible.

Although the agent address can be set to any valid IPv4 or IPv6 address; we recommended that you set the sFlow® agent IP address to be the **local address**¹ that is configured on the switch. This ensures that the sFlow collector can maintain connectivity to the switch irrespective of the addition or deletion of VLAN interfaces (each of which will have its own specific IP address). Note that sFlow is rendered inactive whenever the agent address is not set.

1. For information on local addresses and how to set them up, see the [interface \(to configure\) command on page 12.3](#).

The **no** variant of this command applies its default setting.

Syntax

```
sflow agent {<ip-address>|<ipv6-address>}
no sflow agent {<ip-address>|<ipv6-address>}
```

Parameter	Description
<ip-address>	The IPv4 address of the switch that is acting as the sFlow agent.
<ipv6-address>	The IPv6 address of the switch that is acting as the sFlow agent. The IPv6 address uses the format X:X::X:X.

Default The sFlow agent address is unset.

Mode Global Configuration

Examples To set the sFlow agent (IPv4) address to 192.0.2.23, use the command:

```
awplus# configure terminal
awplus(config)# sflow agent ip 192.0.2.23
```

To set the sFlow agent (IPv6) address to 2001:0db8::1, use the command:

```
awplus# configure terminal
awplus(config)# sflow agent ipv6 2001:0db8::1
```

Related Commands [show running-config sflow](#)
[show sflow](#)

sflow collector (address)

This command sets the sFlow® agent's collector IP address and/or UDP port. This is the destination IP address and UDP port, for sFlow datagrams sent from the sFlow agent. The IP address can be any valid IPv4 or IPv6 address. Note that sFlow is rendered inactive whenever the collector address is set to 0.0.0.0 (for IPv4) or :: (for IPv6).

The **no** variant of this command returns the IP address and UDP port values to their defaults, which will result in sFlow being deactivated.

Syntax `sflow collector {[ip <ip-address>|ipv6 <ipv6-address>]| [port <1-65535>]}`
`no sflow collector {[ip <ip-address>|ipv6 <ipv6-address>]| [port <1-65535>]}`

Parameter	Description
<ip-address>	IPv4 address of the remote sFlow collector.
<ipv6-address>	IPv6 address of remote sFlow collector. The IPv6 address uses the format X:X::X:X.
port	Destination UDP port for sFlow datagrams sent to the collector.
<1-65535>	UDP port number (default: 6343).

Default The collector address is 0.0.0.0 (which renders sFlow inactive), and the UDP port is 6343.

Mode Global Configuration

Examples To set the sFlow collector address to 192.0.2.25 and UDP port to 9000, use the command:

```
awplus# configure terminal
awplus(config)# sflow collector ip 192.0.2.25 port 9000
```

To set the sFlow collector address to 2001:0db8::1 and leave the UDP port unchanged, use the command:

```
awplus# configure terminal
awplus(config)# sflow collector ip 2001:0db8::1
```

Related Commands `show running-config sflow`
`show sflow`

sflow collector max-datagram-size

This command sets the maximum size of the sFlow® datagrams sent to the collector.

The **no** variant of this command resets the maximum-datagram-size to the default value.

Syntax `sflow collector max-datagram-size <200-1500>`

`no sflow collector max-datagram-size`

Parameter	Description
<200-1500>	The maximum number of bytes that can be sent in an sFlow datagram sent from the agent to the collector

Default 1400 bytes

Mode Global Configuration

Example To set the maximum datagram size to 1200, use the command:

```
awplus# configure terminal
awplus(config)# sflow collector max-datagram-size 1200
```

Related Commands `show running-config sflow`
`show sflow`

sflow enable

This command enables sFlow® globally on the switch. Note that sFlow cannot be enabled if Tx port mirroring is enabled on any port on the device.

The **no** variant of this command disables sFlow globally on the switch.

Note that enabling sFlow does not automatically set its operational status to active. To activate sFlow the following conditions need to be met:

- sFlow is enabled.
- The sFlow agent address is set.
- The sFlow collector address is set to a valid (non zero) IPv4 or IPv6 address.
- Polling or sampling is enabled on the ports to be sampled or polled.

Syntax `sflow enable`
`no sflow enable`

Default sFlow is disabled globally on the switch.

Mode Global Configuration

Example To enable sFlow operation, use the command:

```
awplus# configure terminal
awplus(config)# sflow enable
```

Related Commands `show running-config sflow`
`show sflow`

sflow max-header-size

This command sets the maximum header size of the ethernet frames sampled on a specified port. The maximum header size is measured in bytes, referenced from the first byte of the ethernet destination address and excludes the ethernet FCS fields.

If a sampled ethernet frame is longer than the maximum header size set by this command, then the frame will be truncated to the first N bytes before being placed in the sFlow datagram, where N is the maximum header size set by this command.

The **no** variant of this command resets the max-header-size to its default value.

Syntax `sflow max-header-size <14-200>`

`no sflow max-header-size`

Parameter	Description
<14-200>	The maximum number of header bytes to be sampled

Default The max-header-size is 128 bytes.

Mode Interface Configuration

Usage The header size is measured from the first byte of the Ethernet frame MAC Destination Address.

For an environment using standard TCP IPv4 over Ethernet frames, consider the following basic protocol structure:

Ethernet header (including the 4 byte 802.1Q header component) = 18 bytes

IPv4 header = 24 bytes

TCP header = 24 bytes

Total = 66 bytes

See "[Determine the max-header-size for the sampled data.](#)" on page 90.9 for more information on configuring this command

A similar consideration can be made for an environment using TCP IPv6 over Ethernet:

Ethernet header (including the 4 byte 802.1Q header component) = 18 bytes

IPv6 header = 40 bytes

TCP header = 24 bytes

Total = 82 bytes

Caution In the above network scenarios:



- For IPv4 - any data existing between 66 bytes and the value set by this command will be included in the sFlow packet samples. For example, with the default of 128 applied, up to $128-66=62$ bytes of user data could be included in the sFlow datagram samples sent between the Agent and the Collector.
- For IPv6 - any data existing between 82 bytes and the value set by this command will be included in the sFlow packet samples. For example, with the default of 128 applied, up to $128-82=46$ bytes of user data could be included in the sFlow datagram samples sent between the Agent and the Collector.

Note that the agent-to-collector datagrams contain their own UDP headers, which are outside this calculation.

Example To set the maximum header size to 160 bytes for ports 1.0.1 and 1.0.7, use the commands:

```
awplus# configure terminal
awplus(config)# interface port1.0.1,port1.0.7
awplus(config-if)# sflow max-header-size 160
```

Related Commands [show running-config sflow](#)
[show sflow interface](#)
[sflow max-header-size](#)

sflow polling-interval

This command sets the sFlow® counter polling interval (in seconds) for the specified ports. A value of 0 disables polling. A counter sample is taken every N seconds where N is the value set by this command.

The **no** variant of this command applies the default value.

Syntax `sflow polling-interval {0|<1-16777215>}`
`no sflow polling-interval`

Parameter	Description
0	Disable polling (the default).
<1-16777215>	The polling interval in seconds.

Default The polling-interval is 0 (polling disabled).

Mode Interface Configuration

Example To set the polling interval to 60 seconds for ports 1.0.1 and 1.0.7, use the following commands:

```
awplus# configure terminal
awplus(config)# interface port1.0.1,port1.0.7
awplus(config-if)# sflow polling-interval 60
```

Related Commands `show running-config sflow`
`show sflow interface`

sflow sampling-rate

This command sets the mean sFlow® sampling rate for the specified ports. Sampling occurs every N frames (on average), where N is the rate value set via this command. The sampling rate applies to ingress and egress frames independently. For example, a value of 1000 will sample one frame in every 1000 frames received. One in every 1000 frames sent from the specified port. A value of 0 disables sampling on the specified ports.

The **no** variant of this command applies the default value.

Syntax `sflow sampling-rate {0|<50-2147483647>}`
`no sflow sampling-rate`

Parameter	Description
0	Sets the default value.
<50-2147483647>	The sampling rate N, measured in ethernet frames.

Default The sampling-rate is 0 (sampling disabled).

Mode Interface Configuration

Example To set the sampling rate to 500 for ports 1.0.1 and 1.0.7, use the commands:

```
awplus# configure terminal
awplus(config)# interface port1.0.1,port1.0.7
awplus(config-if)# sflow sampling-rate 500
```

Related Commands [show running-config sflow](#)
[show sflow interface](#)

show debugging sflow

This command displays sFlow® debug settings for agent operation, and for sampling and polling on specific interface ports. If no interface ports are specified, sampling and polling will be applied to all ports.

Syntax `show debugging sflow [interface <ifrangle>]`

Parameter	Description
interface	The interface information.
<ifrangle>	The ports for which the sFlow debug settings are to be shown.

Mode Privileged Exec

Example To display sFlow debug settings on the agent, and for sampling and polling on ports 1.0.1 to 1.0.9, use the command:

```
awplus# show debugging sflow interface port1.0.1-1.0.9
```

Output Figure 91-1: Sample obtained for an sFlow agent

```
awplus# show debugging sflow interface port1.0.1-1.0.9
```

sFlow Agent Debug: Enabled		
Port	Sampling Debug	Polling Debug
1.0.1	Enabled	Enabled
1.0.2	Enabled	-
1.0.3	-	-
1.0.4	-	-
1.0.5	-	-
1.0.6	-	Enabled
1.0.7	-	-
1.0.8	-	Enabled
1.0.9	-	Enabled

To display sFlow debug settings for all ports, use the command:

```
awplus# show debugging sflow
```

Related Commands [show running-config sflow](#)
[show sflow interface](#)

show running-config sflow

This command displays the running system information specific to the sFlow feature.

Syntax `show running-config sflow`

Mode Privileged Exec and Global Configuration

Example To display the sFlow running configuration information, use the command:

```
awplus# show running-config sflow
```

Output Figure 91-2: Example output from the `show running-config sflow` command

```
awplus#sh run sflow
!
sflow agent ip 192.0.2.33
sflow collector ip 192.0.2.65
sflow collector max-datagram-size 1200
sflow enable
!
interface port1.0.11-port1.0.22
  sflow sampling-rate 512
```

Related Commands `show running-config`

show sflow

This command displays non-port-specific sFlow agent configuration and operational status.

Syntax `show sflow`

Mode Privileged Exec

Example To display sFlow configuration and operational status, use the command:

```
awplus# show sflow
```

Output

Figure 91-3: Example output from the **show sflow** command

```
sFlow Agent Configuration:                               Default Values
sFlow Admin Status ..... Disabled                    [Disabled]
sFlow Agent Address ..... [not set]                  [not set]
Collector Address ..... 0.0.0.0                       [0.0.0.0]
Collector UDP Port ..... 6343                         [6343]
Tx Max Datagram Size ..... 1200                      [1400]

sFlow Agent Status:
Polling/sampling/Tx ..... Inactive because:
- sFlow is disabled
- Agent Addr is not set
- Collector Addr is 0.0.0.0
- Polling & sampling disabled
  on all ports
```

Table 91-1: Parameters in the output of the **show sflow** command

Output Parameter	Description
sFlow Admin Status	Whether sFlow agent operation is administratively enabled.
sFlow Agent Address	The sFlow agent IPv4 or IPv6 address for the device. sFlow is rendered inactive whenever the agent address is not set.
Collector Address	The IPv4 or IPv6 collector address to which sFlow datagrams are sent. sFlow is rendered inactive whenever the collector address is set to 0.0.0.0 or 0:0::0.0.
Collector UDP Port	The UDP port on the collector to which sFlow datagrams are sent.
Tx Max Datagram Size	The maximum size of the sFlow datagrams sent to the collector.
Polling/sampling/Tx	Whether sFlow sampling and/or polling (and hence sFlow datagram transmission) are active. If inactive the reasons are listed.

Related Commands [show running-config sflow](#)
[show sflow interface](#)

show sflow interface

This command displays sFlow agent sampling and polling configuration for specified ports.

Syntax `show sflow interface <ifrange>`

Parameter	Description
<ifrange>	The interface range.

Mode Privileged Exec

undebug sflow

This command applies the functionality of the [no debug sflow command on page 91.2](#).

Part 8: Virtual Chassis Stacking



- Chapter 92 Stacking Introduction
- Chapter 93 Stacking Commands

Chapter 92: Stacking Introduction



VCS Introduction.....	92.2
VCS Supported Platforms.....	92.2
Features of Virtual Chassis Stacking.....	92.2
The Physical Stack.....	92.3
Two Switch Stack Configuration.....	92.3
Resilient Stacked Topology.....	92.6
Stack Formation.....	92.8
The Role of the Stack Master.....	92.8
Stack Management VLAN.....	92.10
Stack Member Failure and Recovery.....	92.13
Fixed or Virtual MAC Addressing.....	92.13
Stack Resiliency Link.....	92.14
VCS Failure Recovery.....	92.16
Stack Maintenance.....	92.16
Provisioning (Stack Members).....	92.18
Provisioned Board Classes.....	92.18
Applying Hardware Provisioning.....	92.19
Removing Hardware Provisioning.....	92.21
Displaying Provisioned Configurations.....	92.22
Provisioning and Configuration Management.....	92.23
Software Version Aspects.....	92.24
Software Version Auto Synchronization.....	92.25
Introduction.....	92.25
How Autosynchronization Works.....	92.25

VCS Introduction

This chapter describes Virtual Chassis Stacking (VCS), its features, and basic connection examples.

A Virtual Chassis Stack (VCS) is a group of physically separate switches that are connected so as to function as a single logical switch. In order to function as a VCS, its component switches are connected using high-speed stacking links. Software Version 5.3.4-0.1 supports a maximum of four devices per stack on the x600 series switches and two devices per stack on the x900 and SwitchBlade x908 series switches.

VCS Supported Platforms

VCS is supported on the following switch types:

- x900-24XT, x900-24XS, x900-24XT-N
- x900-12XT/s
- SwitchBlade® x908, and
- x600 series.

Switches must be of the same product type to exist within the same stack. The principles of product / stack compatibility is shown in the following table.

Table 92-1: Stacking compatibility by product type

Product Types	x900-24XS, x900-24XT, x900-24XT-N	Via XEM-STK ports.
Product Type	x900-12XT/s	Via XEM-STK ports.
Product Type	SwitchBlade® x908	Via either XEM-STK ports, or high speed rear chassis ports.
Product Type	x600 (all variants)	Via AT-StackXG ports.

Features of Virtual Chassis Stacking

Creating a VCS greatly eases network management, because you can configure all the stacked devices via a single IP address. Creating a VCS will often eliminate your need to configure protocols such as VRRP and Spanning Tree. VCS also enables you to create highly resilient networks. This resiliency can be applied in several ways.

Within the stack itself, switch interconnection is via two links. The second link is able to provide an alternative data path, thus the stack will continue to function if a single switch fails. Degraded performance might occur however, due to the reduced VCS bandwidth.

User ports can also be made extremely resilient by utilizing link aggregation. Aggregated links can span ports, modules, and even switches within the stack. Creating aggregated links that span multiple switches within a stack creates an extremely resilient configuration. Communication will still exist even if a switch and its aggregated ports fail. Refer to [Figure 92-4 on page 92.6](#).

The Physical Stack

A stack - depending on the switch types used - comprises 2 individual stack members interconnected via a high speed stacking link. A stack always has a primary stack member called the *stack master*, and a secondary stack member.

The basic stack configurations are:

- Two stack members connected in a ring topology via their stack XEM modules. All models.
- On SwitchBlade® x908 two stack members can be connected via their back plane chassis connections - a variation of the ring topology.

XEM Module - Cables and Connections

The XEMStack ports use special cables to construct the physical stack; these are:

- AT-XEM-STK-CBL0.5 (0.5 metres long)
- AT-XEM-STK-CBL2.0 (2 metres long)

Chassis Rear - Cables and Connections

The chassis rear stacking ports use special cables to construct the physical stack; these are:

For the back panel chassis connections on the SwitchBlade x908, use the cable type AT-HS-STK-CBL1.0 (1 metre long).

Note Port 1 on one switch must connect to port 2 on the other (or next) switch.



Two Switch Stack Configuration

This configuration, shown in Figure 92-1 on page 92.3, uses two switches that are connected via their high-speed stacking links and an optional *resiliency* link. Note that stacking ports labeled 1 must connect to stacking ports labeled 2. In this configuration the stack can still function using only a single high speed link.

Figure 92-1: Two Switch Stack Configuration

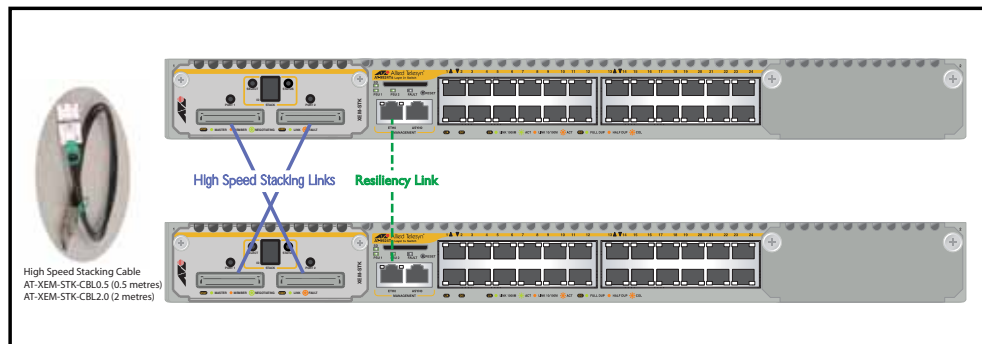

On the SwitchBlade® x908, the two switch configuration can use either the connections on a XEM stacking module, or use stacking ports 1 and 2 located on the chassis rear panel. The chassis rear panel connections have a faster data rate, but do require a special cable.

Resiliency Link

The resiliency link carries no network data. Its function is to provide additional stack status information to enable the stack members to more accurately decide whether it is appropriate for one of them to take over the role as stack master if the existing master fails. See [“Stack Resiliency Link” on page 92.14](#).

A resiliency link can be created using a single physical connection between two eth0 ports, or it can use a VLAN (resiliency link VLAN) to which the switch ports can be attached.

To create a resiliency link using eth0 ports, connect a standard twisted pair LAN cable (either straight through, or crossover - MDI-MDIX negotiation is supported on these ports) between the two eth0 ports on both devices. Once you have connected the cable you can run the [stack resiliencylink command on page 93.31](#) to create the resiliency link.

Resiliency Link Configurations via Switch Ports

Two resiliency-link configurations that connect to switch ports are shown below. [Figure 92-2](#) shows the resiliency link connecting in a ring topology, whilst [Figure 92-3](#) shows the resiliency link connecting to the switch ports via a network hub. In both configurations, the resiliency link connections are made using the ResiliencyLink VLAN and attaching the switch ports to the VLAN. For more information on using the resiliency link commands see: [stack resiliencylink command on page 93.31](#) and [switchport resiliencylink command on page 93.37](#).

Figure 92-2: Resiliency link connecting to switch ports over the ResiliencyLink VLAN

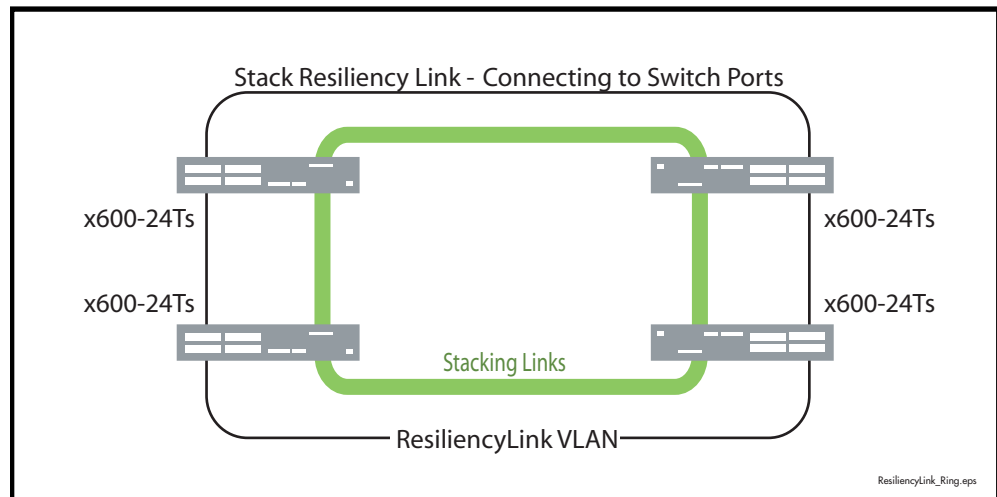
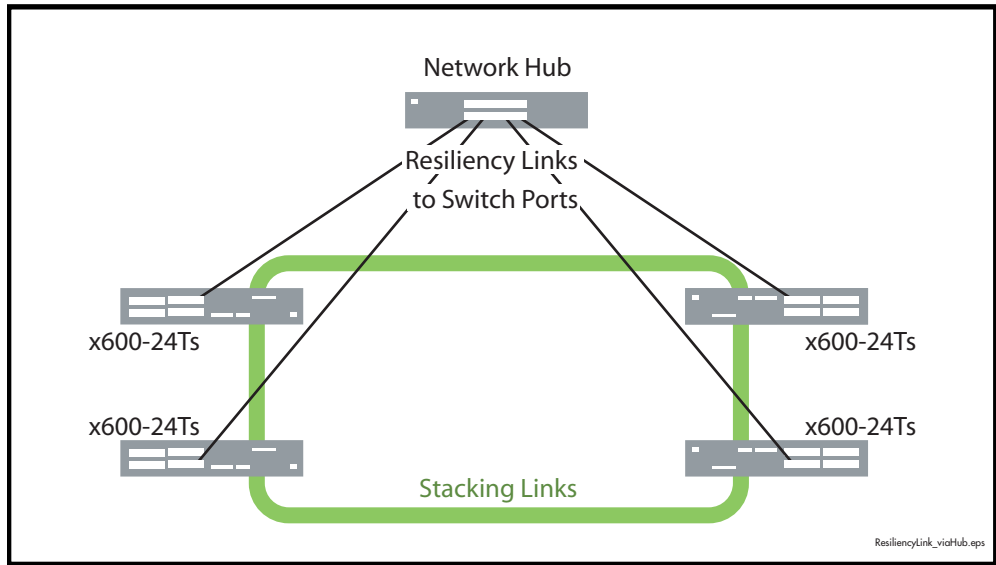

Figure 92-3: Resiliency link connecting to switch ports over the ResiliencyLink VLAN Using a network hub.



Resilient Stacked Topology

Where network connectivity uptime is a major criteria, you can use virtual chassis stacking to create highly reliable network configurations. The network shown in [Figure 92-4](#) employs duplicate links and switches to create a stacked network that offers extremely reliable user connectivity.

Figure 92-4: VCS Resilient Stacked Topology Example

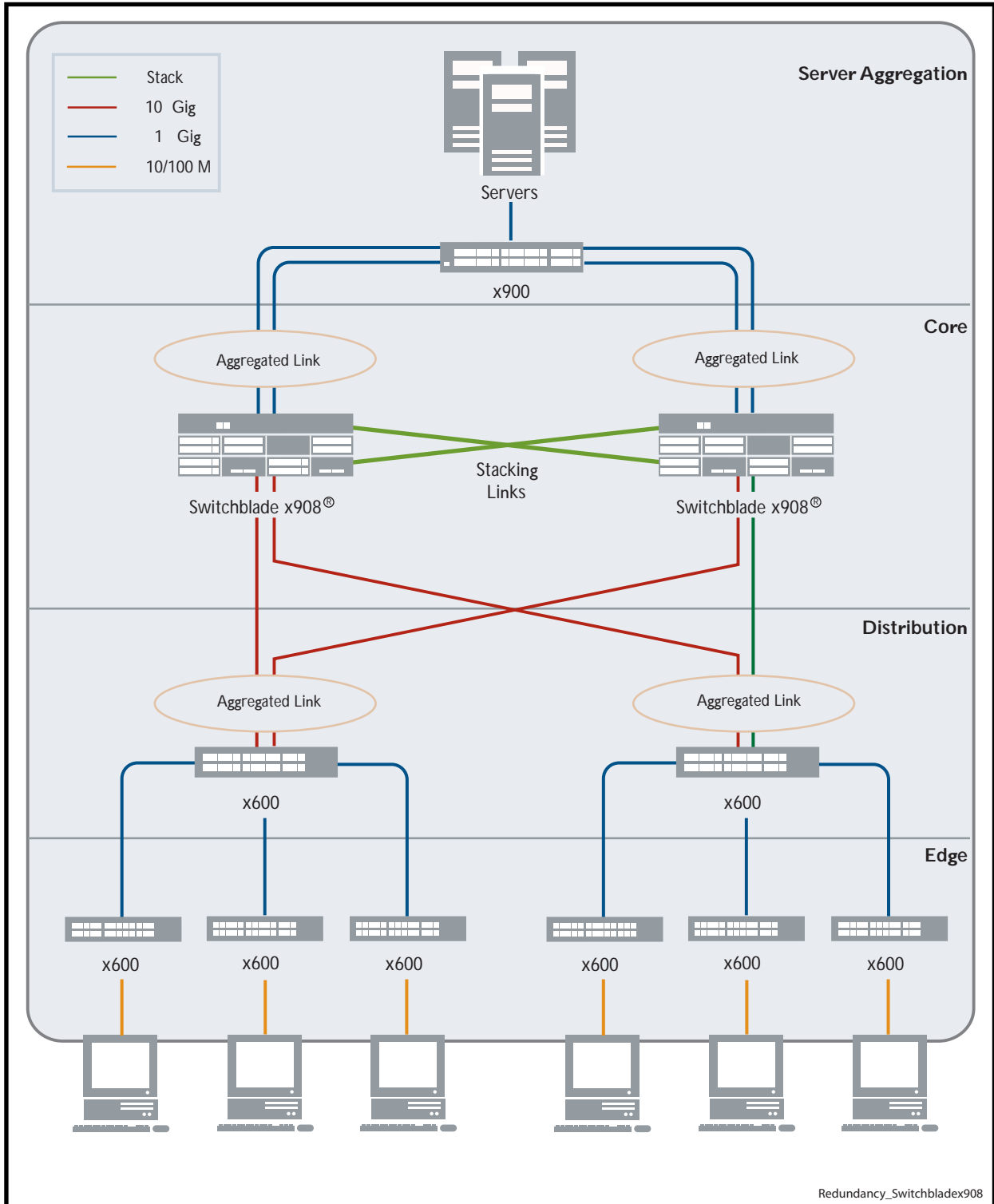

This network employs two SwitchBlade® x908 switches to form an expandable network core. These switches are stacked and so appear as a single logical switch (note that smaller switches such as the x600 can be also be used to form the stacked core).

This network topology supplies multiple dual connections to a number of downstream distribution switches that can in turn connect to user devices. Similarly, the dual network paths provide very reliable connectivity to the server aggregation portion of the network.

Employing link aggregation rather than spanning tree to manage the parallel paths, enables the bandwidth of both data links to be utilized under normal conditions, whilst enabling a single data link to operate should its partner link fail.

Stack Formation

As previously mentioned, a VCS always contains a master and a stack member. To be part of a stack, a switch must connect to the other potential stack member via dedicated stacking ports. These ports can either be those on the front of a XEM-STK stacking module, or in the case of the SwitchBlade x908, the stacking ports located on the back panel. [Figure 92-5 on page 92.8](#) shows a stacking XEM-STK module.

Figure 92-5: VCS Stacking Module (XEM-STK)

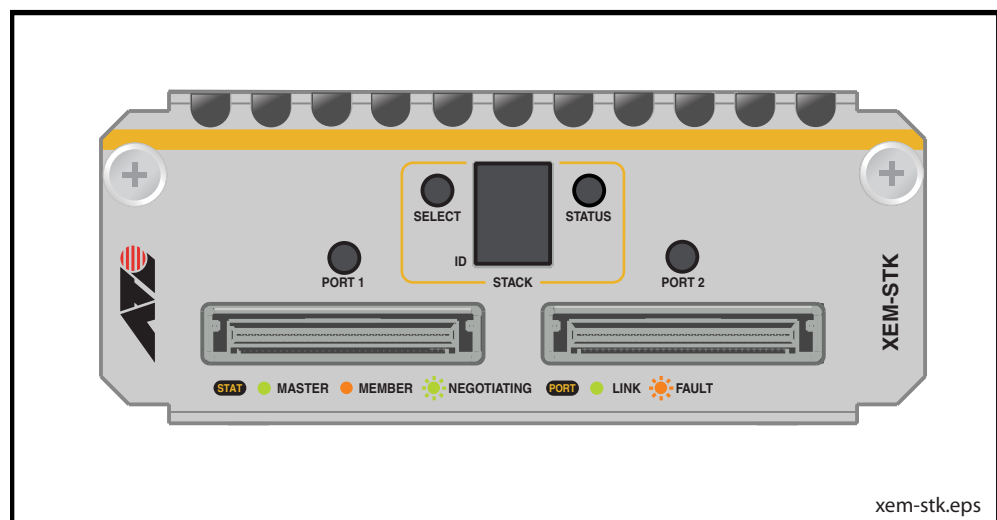

On the SwitchBlade[®] x908, at least one non XEM-STK must be installed in the switch before it is able to participate as a stack member. The SwitchBlade x908 will remain a standalone node until a non-stacking XEM is inserted, at which point it will initiate a topology discovery sequence and join the stack. Note that when the SwitchBlade x908 is operating as a standalone node it will not switch data around the stacking ring.

Once the switches have been physically connected to form a stack, powering all the members on automatically sets off a number of processes that enable the stack members to detect the presence of the other stack members and form themselves into a VCS.

The Role of the Stack Master

In addition to being a member of its VCS stack, the stack master manages functions such as software version control and distribution, routing processing, and network management.

Selecting the Stack Master

The stack members are able to automatically select which switch will become the stack master. This selection is based on two components:

1. The stack member's priority setting.
2. The stack member's MAC address.

For both components, the lower the number the higher the priority. To set the stack priority, run the [stack priority command on page 93.28](#). Note that changes to these settings will not take effect until the next master re-election. To display these components run the [show stack command on page 93.18](#).

The master is the switch with the lowest 'priority setting', or if the 'priority settings' are equal, the switch with the lowest MAC address will become the stack master. When a stack member is initially booted, its priority value defaults to 128. Therefore if all switches retain their defaults, then the stack master will be determined by MAC address comparison.

The stack also assigns a Stack Member-ID number to each member. This number provides a unique reference number for switches within the stack; it plays no part in selecting the stack master. The Stack Member-ID is the entity used as the first digit of the three component port identifier numbers. For example, port number 2.0.14 has the Stack Member-ID of 2.

Note  This last point is an important one to remember when using configuration scripts. You should ensure that you modify your configuration scripts to match any changes you have made to the Stack Member-ID assignments.

Note  The ability to independently set both a stack member's priority and its ID means that the stack master does not need to have an ID of 1; although configuration is simplified by arranging for ID 1 to be the device with the lowest priority value - and thereby forcing it to be the stack master. If you create a stack using new switches, the following (simplified) process should ensure that the master member has an ID of 1.

New switches are shipped with a Stack Member-ID of 1 and a priority of 128. If two such switches are created as a stack, the switch with the lowest MAC address will be selected to be the stack master (because all priority settings are 128). The remaining stack member device will then reboot. The stack master does not reboot and retains its Stack Member-ID of 1.

You can change the Stack Member-ID by using either the ID select button on the XEM-STK, or by using the [stack renumber command on page 93.29](#).

Common Stack Configuration

Once the switches have configured themselves into a VCS stack, they all share the same configuration information and startup scripts.

Caution  Once the stack is formed, each stack member's configuration is associated with its Stack Member-ID number. Pressing the *select* button on a XEM-STK will set its switch member to have Stack Member-ID 1, and *it will acquire the configuration settings assigned to that particular ID number*. The other switch in the stack will then realign its Stack Member-IDs according to the stack's physical topology.

Stack Management VLAN

Managing the stack is the same as managing an individual switch. You can connect to the asynchronous console port of any stack member, or you can set an IP address on a network VLAN (for example, VLAN 1) and use SSH for remote access.

As the switches form themselves into a stack, each switch creates a common stack management VLAN and a management IP address. Both the VLAN ID and the IP address are internal entities that are used between the stacked switches, via either the stack XEM or rear panel interfaces, and therefore do not appear on the user network.

Initially the stack assigns the default VLAN tag ID of 4094 to the management VLAN, and assigns an IP address from the subnet 192.168.255.0 / 28 to this VLAN as the management IP address. Once the stack has formed, you can change both these settings. To change the VLAN ID use the [stack management vlan command on page 93.27](#). To change the management IP address use the [stack management subnet command on page 93.26](#). Note however, that you must keep the 28 bit subnet mask, (/28 or 255.255.255.240). Also note that because the stack's internal address mapping tables will register the management VLAN ID and the management IP address, these must be unique across the stack's internal and external network. To view the current settings for the stack management VLAN ID and IP address, use the [show stack command on page 93.18](#).

Stack member identification

When a switch that is connected via a XEM-STK module, becomes a stack member, the numeric display on the XEM-STK indicates the switch's member ID, see the [Figure 92-6 on page 92.11](#). If the switch is not a stack member, the XEM-STK seven-segment display will be blank. The following LEDs indicate the switch's status within the stack.

Table 92-2: Stacking LED Functions

LED	State	Meaning
Port 1 and Port 2	Green	A stacking link is established
	Amber (flashing slowly)	The link has transmission fault
	Off	The stacking link is down
Status	Green	The switch is the stack master
	Amber	The switch is a (non master) stack member
	Green (flashing)	The stack is selecting a stack master
	Off	The switch is not a stack member
Numeric ID	1 to 4	The stack member ID
	Off	The switch is not a stack member

The following figure shows the XEM-STK ports and LEDs.

Figure 92-6: XEM-STK LEDs

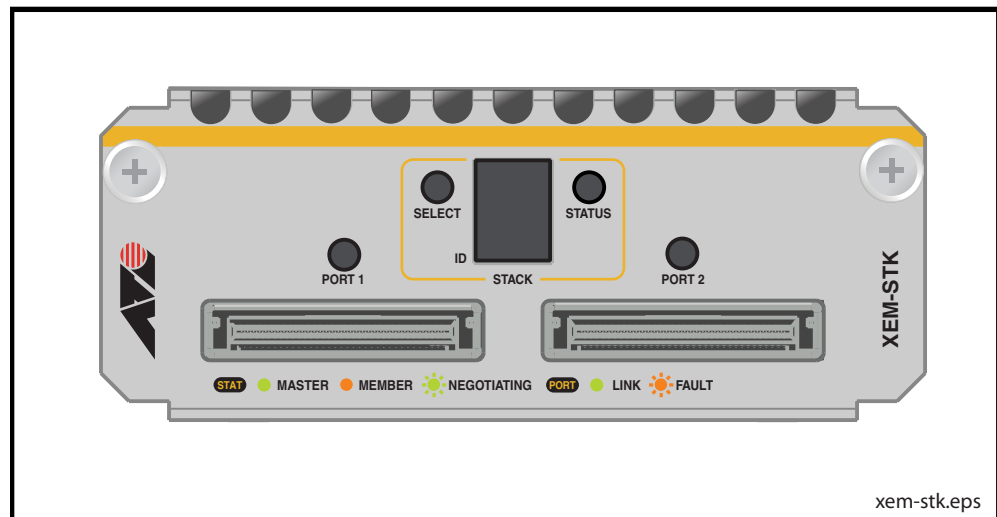
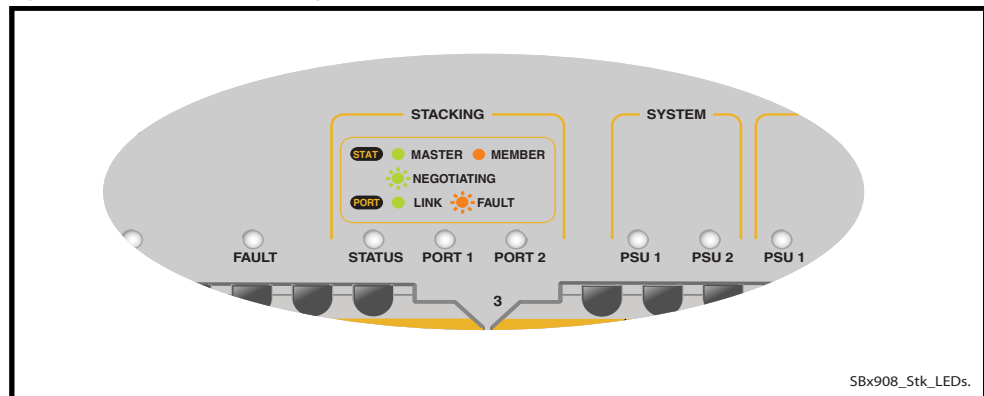

Figure 92-7: SB x908 Stacking LEDs (SwitchBlade x908)



Running commands on specific stack members

In some situations you may want to obtain information that is specific to a particular stack member. To achieve this you can use the **remote-command** feature. For example, to see the processes running on stack member 3, you can run the following **remote-command**:

```
awplus# remote-command 3 show process
```

For more information and options on this feature, see [remote-command command on page 93.7](#) of this manual.

Running QoS within a VCS stack

In general you can apply the same principles when configuring QoS on a VCS stack as you would for single switch; however there are a few specific changes that you will need to make.

Switches within a VCS stack, exchange their stack management information and user data over their high speed inter-stacking links. The stack management information is pre-assigned to the egress queue 7. This is the highest value queue, and (in a stacked configuration) its traffic should not be shared with any user data. However, any CoS tagging of 7 applied to the incoming data will automatically be assign to queue 7 as it crosses the internal stacking links. You will therefore need to reconfigure your CoS to Queue settings to ensure that no user data is sent to queue 7.

To prevent this from happening, we recommend that you make appropriate changes to your queue settings (mappings) to reflect the stacking requirement previously described. For more information on this topic, see ["Mapping CoS tags to traffic types" on page 52.13](#).

This process should include (but not be limited to) running the following command to ensure that any remaining user packets still carrying a CoS 7 tag, will be mapped to egress queue 6.

To remap priority CoS traffic to egress queue 6, run the following command.

```
awplus# configure terminal
awplus(config)# mls qos map cos-queue 7 to 6
```

Stack Member Failure and Recovery

Fixed or Virtual MAC Addressing

A VCS Stack operates using a single **virtual** MAC address. This address is configurable by using the [stack virtual-mac command on page 93.35](#).

Stack virtual-mac Command Enabled

When the [stack virtual-mac](#) command is enabled, the stack uses a virtual MAC address that is either manually entered, or has been randomly selected from an allocated pool of MAC addresses. The stack will then always use this MAC address even if the stack master fails or is removed from the stack. In this situation, the new elected master will still retain the originally configured virtual MAC address.

The virtual MAC address will be used for all external ports, and VLAN interfaces, except the management VLAN. Although each individual switch in the stack retains its own native MAC address; this is only used over the stack management VLAN.

Note  If one stack member has the virtual MAC address feature enabled and another has the virtual MAC address feature disabled then they will be able to form together as a stack. From master election onwards, the stack master's virtual MAC address setting will be used by the rest of the stack.

Virtual MAC format and value

The virtual MAC address is selected from within the range 0000.cd37.0000 to 0000.cd37.0FFF. This can be considered as a MAC prefix component of 0000.cd37.0xxx. Where xxx is called the stack virtual-chassis-ID, and has the range 000 to FFF.

Manually selected virtual address

To manually select a virtual MAC address you enable the stack virtual MAC feature by using the commands:

```
awplus# configure terminal
awplus(config)# stack virtual-mac
```

Then configure the [stack virtual-chassis-id command on page 93.34](#) to set a stack virtual-chassis-ID of your chosen value - entered as a decimal number within the range 0 to 4095. The value 120 is used in the following example:

```
awplus# configure terminal
awplus(config)# stack virtual-chassis-id 120
```

Automatically selected virtual address

If you set the [stack virtual-mac](#) command without entering a value for the stack virtual-chassis-ID, the switch will randomly select a virtual-chassis-ID from the allocated range.

Stack virtual-mac Command Disabled

When the `stack virtual-mac` command is disabled, the stack will use the MAC address of the current Master. If the stack master fails, the stack MAC address changes to reflect the new master's MAC address. If the stack MAC address does change, ARP tables of devices on the network will update to reflect the change in MAC address via [ip gratuitous-arp-link command on page 23.19](#).

Stack Resiliency Link

The purpose of the resiliency link is to provide the stack members with status information that enables them to detect whether the stack master is still operational after it has suffered either a power-down or software lock-up. This enables the other stack members to either operate in the fall-back mode, or to re-elect a new stack master. The ["State Change Table" on page 92.14](#) shows how the stack members respond to various problems occurring on the master node.

Stack Recovery States

The following state-change-table shows stack member failure conditions and recovery actions in situations where the resiliency link is present or absent.

Table 92-3: State Change Table

Event on Master Node	Reaction on Master	Reaction on Stack Member	Reaction on Stack Member
		With Resiliency Link	Without Resiliency Link
Both stack links removed	No change	Fallback action ¹	Re-elect master ²
XEM-STK Removed or Faulty	No change	Fallback action ¹	Re-elect master ²
Hardware reset (or fault)	Reset / offline	Re-elect master	Re-elect master ²
Run the no stack enable command ³	No change	Fallback action ¹	Not allowed Displays Error Message
Software application problem (lock-up or continual crashes)	Reboot as stack member	Re-elect master	Re-elect master
Software crash or lock-up	Frozen ⁴	Re-elect master	Re-elect master
Power-down or PSU failure	Powered down	Re-elect master	Re-elect master
Event on Stack Member Node	Reaction on Master	Reaction on Stack Member	Reaction on Stack Member
Both stack links removed	No change	Fallback action ¹	Re-elect master ²
XEM-STK removed or faulty	No change	Fallback action ¹	Re-elect master ²
Hardware reset (or fault)	No change	Reset/offline	Reset/offline
Run the no stack enable command ³	No change	Fallback action ¹	Fallback action ¹
Software application failover (lock-up or continual crashes)	No change	Re-boot as slave	Reboot as stack member
software crash or lock-up	No change	Frozen ⁴	Frozen ⁴
Power-down / PSU failure	No change	Powered Down	Powered down

1. The fallback action on a slave is first to disable all its switch ports, then to activate any triggers of "type stack disabled-master" that have been configured.

2. The stack member assumes the role of stack master. In specific situations this condition could result in a stack containing two masters. This would present problems with network management and the control of links that were previously aggregated.
3. The following situation will apply to a switch that has been removed from the stack by the using the “no stack enable” command:
 - « The switch will be unaware of further faults within the stack it was previously a member of.
 - « Should this switch then be powered down, all links previously shutdown (as a result of running the “no stack enable command”) will remain down.
4. If the slave's ports are still up, this may cause downstream switches with trunked ports to operate incorrectly.

VCS Failure Recovery

If the stack master either fails, or is removed, the other stack members will decide which of two actions to take.

1. Fallback action.
2. Re-elect a new stack master.

Note that a master fail-over will be slower than a stack member failure, and will require the restart (reconvergence) of routing protocols such as RIP.

[Table 92-3](#) shows how the stack (non-master) members would respond to various problems occurring on the stack master stack.

Re-elect New Stack Master

The stack members automatically determine which of them becomes the new VCS master.

Recombining Separated Stacks

When two separated stack units (stubs) are reconnected, a condition known as 'multiple master' will be detected. In this situation, a new VCS master is elected based upon the lowest Priority ID or (where both members have the same Priority ID) the lowest MAC address. The 'losing' master and the other prospective stack members will then reboot and join the new stack as ordinary stack members.

Note  When VCStack is used with EPSR, the EPSR **failovertime** must be set to at least 5 seconds to avoid any broadcast storms during failover. Broadcast storms may occur if the switch cannot failover quickly enough before the EPSR **failovertime** expires. See the [epsr](#) command for further information about the EPSR **failovertime**. See the [reboot rolling](#) command for further information about VCStack failover.

Stack Maintenance

Adding a Stack Member

An unstacked switch can be added to an existing stack (hot swapped in) with minimal impact on traffic. To do this, power down the new member switch, then connect its stacking ports and power on the switch. The switch will boot as a member of the stack.

Note  The existing Stack Member-ID and the device MAC address will have no effect on the status of the new member switch. The stack will admit the new device as ordinary stack member and allocate it a new Stack Member-ID if its ID is one that already exists.

However, for good practice we recommend pre-configuring the new member with settings that are appropriate for when the new switch becomes a stack member. This is to avoid unexpected situations occurring when the stack is rebooted. For example, if the new member had a priority setting that was lower than 128 and all the existing stack members were configured with the default; then, when the stack is rebooted, the new member would be elected as the stack master.

Replacing a Stack Member

A stack member can be removed from a stack (hot swap out) with minimal impact on stack traffic. To do this power-down the stack member, disconnect its XEM-STK ports. Insert the new stack member, reconnect the stacking ports and power-up the new stack member.

You can seamlessly swap a stack member switch into the stack to replace another with the same configuration. This provides a simple way to replace an out of service switch with minimal impact, and minimal administration requirement. You should configure the replacement switch with the same member ID as its replacement prior to its insertion into the stack.

Repairing a Broken Stub

Stack stubs occur when a fault results in stack splitting into two, with one of the stack members takes on the role of stack master. Where (unknown to some of the stack members) the master is still active, the result can be two independently operating stacks. These are termed stubs.

When two stub stacks are reconnected, a dual master situation will be detected, and the console log will display the message, 'duplicate master' was detected. This situation results in the re-election of the stack master. The losing master will return to being a stack member.

Note Stubs are unlikely to occur where resiliency links are used.



Provisioning (Stack Members)

Stack member provisioning is the pre-configuration of stack member position ready for insertion at a later time. Presently the following stack members can be provisioned:

- Switch stack members within a VCStack on SBx908, x900 and x600 series switches.

Provisioning enables a network administrator to pre-configure vacant stack member capacity within a VCStack, ready to be hot-swapped in at a later time. Later, when the stack member switch is physically added, its configuration is automatically applied with the minimum network disruption. Provisioning is ON by default, and cannot be disabled.

Provisioned capacity can be applied by either of the following actions:

- Applying the appropriate provisioning command
- Installing, then removing a provisionable device from its physical location, i.e. a switch from its stack.

When a vacant switch is provisioned, its ports are assigned the shutdown state and are therefore not able to be activated. Applying the shutdown or no shutdown commands to a provisioned port will change only its administrative state.

Provisioned Board Classes

Provisioning introduces the concept of defined board classes. [Table 92-4 on page 92.18](#) lists the stack member classes that have been defined for provisioning: Each board class is assigned a **class** and an appropriate **port count**. Presently no further definitions have been made for additional features such as media type, or PoE capability. This structure simplifies configuration. For example:

Provisioning limits for devices and ports

Table 92-4: Provisioned Stack Member Classes

Board Classes		
Class	Port Count	Bays
x900-12	12	1
x900-24	24	2
SBx908	0	8

These devices have the following device and port limits.

Table 92-5: Maximum Device and Port Limits per Product Type

Device Type	Device Limit	Port Limit
SBx908	2	192
x900	2	96

Note that although the SBx908 switch can be provisioned with VCStack IDs of 1-4, and x900 switches are able to be provisioned with VCStack IDs of 1-8, both of these switch families have the limit of two switches per stack.

Applying Hardware Provisioning

As previously mentioned, provisioning is the pre-configuration of vacant (i.e. unused) device capacity ready for device insertion at a later time.

Without provisioning

On software versions prior to version 5.3.4 - trying to configure an unused port will result in the following error message:

```
awplus(config)# interface port4.0.1
% Can't find interface port4.0.1
```

With provisioning

With provisioning you can configure a stack members and their ports, even though they are not currently physically present, and configure them ready for future addition:

```
awplus(config)# switch 4 provision x600-24
```

Now that the switch is provisioned within the stack - although not yet physically present - you can move on to provisionally configure the switch ports themselves. The following example sets the port speed of port 4.0.1 to be 1000 kbps.

```
awplus(config)# interface port4.0.1
awplus(config-if)# speed 1000
```

You can apply provisional configuration to all interface related commands. However, you cannot apply provisioning where it changes the network's physical topology. For example, you can't provision a switch as stack member 3 and then later change it - while its position is still vacant - to stack member 4. In this situation, you would need to unprovision the switch, then provision it again as stack member 4.

The following example creates a provisioned configuration that shows the association of ports with a VLAN:

```
awplus# configure terminal
awplus(config)# vlan database
awplus(config-vlan)# vlan 12 state enable
awplus(config-vlan)# exit
awplus(config)# interface port2.0.1
awplus(config-if)# switchport mode access
awplus(config-if)# switchport access vlan 12
awplus(config-if)# exit
awplus(config)# interface port2.0.2-port2.0.26
awplus(config-if)# switchport mode access
```

Provisioning Error Messages

The following error messages may appear when configuring provisioning.

Table 92-6: Provisioning Error Messages (switch x [bay y] provision)

Error Message	Comment
% Maximum port count (208) reached. No more devices can be provisioned	Allows for a maximum eight 24 port x600 switches in a VCStack
% Maximum stack size (%d) reached. No more switches can be provisioned	%d = 2 for x908 or x900 = 8 for x600
Switch %d must be provisioned before bays can be provisioned.	%d = stack member id
% Switch %d (%s) has 0 expansion bays.	%d = stack member id %s = board class
% Board class %s is incompatible with this system.	%s = board class from cmd line. Indicates x600/x900 class mismatch
% Board class %s is incompatible with existing stack members.	%s = board class from cmd line. Indicates a mismatch between x900-class devices.
% Cannot provision %s as this would exceed system port limit (208)	%s = board class from cmd line. Indicates that port count is currently < 208, but provisioning this device would exceed that.
% switch %d is already populated with %s.	Indicates an attempt to provision a switch that is already present.
% switch %d is already provisioned for %s.	Indicates an attempt to provision a switch that is already provisioned.
% switch %d bay %d is already populated with %s.	Indicates an attempt to provision a XEM bay that is already populated.
% switch %d bay %d is already provisioned for %s.	Indicates an attempt to provision a XEM bay that is already provisioned.

Table 92-7: Provisioning Error Messages (no switch x [bay y] provision)

Error Message	Comment
% switch %d bay %d is currently populated by %s	You must remove hardware before unprovisioning

Removing Hardware Provisioning

Hardware capacity that has been previously provisioned *and presently unoccupied* can be unprovisioned with the **no switch provision** command. This removes the provisioned configurations for hardware that has either yet been physically added to a switch or VCStack, or has previously existed, but has been removed.

The **no switch provision** command will also delete any switch bay commands with the same unit number and all associated interfaces, as well as all configuration for that switch or XEM module.

You cannot unprovision hardware that is currently installed. A **no switch** command will not succeed if the unit/unit.bay location is currently occupied. For example:

```
awplus(config)# no switch 2 bay 8 provision
                    % switch 2 bay 8 is currently populated
                    by xem-1
```

The following example displays the output of a show stack that includes a provisioned VCStack member 3:

```
Virtual Chassis Stacking summary information
ID Pending ID MAC address Priority Status Role
1 - 0000.cd28.5377 128 Ready
ActiveMaster
2 - 0000.cd29.95bf 128 Ready
BackupMember
3 - 0000.0000.0000 - -
Provisioned
```

Switch ID 3 is then unprovisioned:

```
awplus(config)# no switch 3 provision
```

Run the show stack command to confirm that switch 3 has been unprovisioned.

```
awplus# show stack
```

```
Virtual Chassis Stacking summary information
ID Pending ID MAC address Priority Status Role
1 - 0000.cd28.5377 128 Ready
ActiveMaster
2 - 0000.cd29.95bf 128 Ready
BackupMember
```

Note Ensure that you save the config after making any provisioning changes.



Displaying Provisioned Configurations

In this respect the major difference associated with provisioning, is that interface configurations will still exist in the config files and will appear in show commands, even though a device itself may not be physically installed. This (provisioning) could result from device capability that has been preconfigured for future installation, or could result from the removal of an installed device.

The **show running-config** command includes switch commands for existing hardware, plus all non-existent, but provisioned, hardware. The following example output of the **show running-config** command illustrates how provisioned and existing hardware is displayed.

Figure 92-8: Sample display of existing and provisioned show output

```
sh running-config
.
.
switch 1 provision x908
switch 1 bay 1 provision xem-12
switch 1 bay 2 provision xem-12
switch 1 bay 3 provision xem-12
switch 1 bay 5 provision xem-12
switch 1 bay 7 provision xem-1
switch 1 bay 8 provision xem-1
switch 2 provision x908
switch 2 bay 1 provision xem-12
switch 2 bay 2 provision xem-12
switch 2 bay 3 provision xem-1
switch 2 bay 8 provision xem-1
!
interface port1.1.1-1.1.12
  switchport
  switchport mode access
!
interface port1.2.1-1.2.12
  switchport
  switchport mode access
!
interface port1.3.1-1.3.12
  switchport
  switchport mode access
.
.
.end
```

Displaying provisioned hardware status

The status, present or provisioned, appears in monitoring commands such as the show interface brief. The following sample output from the show interface brief command shows the provisioning status of two configured stack members.

Figure 92-9: Sample display showing hardware provisioning status

Interface	Status	Protocol	Status
port1.1.1	admin up	running	present
port1.1.2	admin up	down	present
.			
port2.8.1	admin up	down	provisioned

A more detailed inspection of the provisioned port 2.8.1 is shown below. Note that the MAC address of 0000.0000.0000, which is the value applied as a placeholder for all provisioned ports. Also note that although the port is in the link DOWN state its administrative state of UP PROVISIONED means that it can be further configured. For example, it can be associated with a VLAN, or added to a link aggregation group etc.

Figure 92-10: Sample display showing provisioning status of a specific port

```
Interface port2.8.1
  Scope: both
  Link is DOWN, administrative state is UP PROVISIONED
  Thrash-limiting
    Status Unknown, Action learn-disable, Timeout 1(s)
  Hardware is Ethernet, address is 0000.0000.0000
  index 6801 metric 1 mtu 1500 mru 1522
  <BROADCAST,MULTICAST>
  VRF Binding: Not bound
  SNMP link-status traps: Disabled
    input packets 0, bytes 0, dropped 0, multicast packets 0
    output packets 0, bytes 0, multicast packets 0 broadcast
  pks0
```

Provisioning and Configuration Management

A benefit of provisioning is configuration settings are no longer dependant on the existence of hardware devices. When a device is removed, all the interfaces for that device are shutdown and its provisioning status is set. This means that you can add or remove physical hardware without affecting your network interfaces. Of course when ports go down (i.e. are physically removed) there will be other changes to network configuration, as protocols may re-converge or, for example, routes be removed etc.

Switches within a VCStack (or XEMs within a switch) can be hot-swapped without the need for reconfiguration.

The configuration of a newly inserted device that matches the provisioned board-class is achieved on a best-effort basis. For example inserting a non-POE switch into a stack member location configured for PoE will result in the failure of the PoE configuration commands.

Take care that your provisioned configurations, match with the type of hardware that you plan to install. For example, the XEM-12 configuration shown below has the port speed set for one of its ports:

```
awplus(config)# switch 2 bay 4 provision xem-12
awplus(config)# int port2.4.1
awplus(config-if)# speed 10
```

This will be fine if a XEM-12T is installed; however installing a XEM-12S (a device that cannot run its ports at 10 Mbps) would result in an error condition.

Software Version Aspects

When upgrading to version 5.3.4: The provisioning commands will automatically be added to the running configuration of the switch - all other configuration will remain unchanged

When downgrading from 5.3.4: (for example from 5.3.4 back to 5.3.3) error messages will result if the configuration has been saved using the 5.3.4 version software. This is because the provisioning commands in the configuration file will be unknown to the 5.3.3 version software.

If the configuration has not been saved with the version 5.3.4 software release, then downgrading will not result in error messages. This is because the saved configuration will not contain provisioning commands. All other commands will be unaffected, and the switch will operate as previously.

Software Version Auto Synchronization

Introduction

Different software releases have functional and operational differences between them. To maintain consistent behavior across the stack, all new member switches must be running the same software release before they can fully join the stack.

Manually upgrading the software release of each new stack member joins a stack would be a cumbersome process. The VCS software version auto synchronization feature automates this process by ensuring the same software release is used on all stack members, and automatically upgrading stack members where required.

How Autosynchronization Works

Software version comparison

When the stack is formed, it elects one of its switches to become the master. The software release running on the stack master will then become the software version used throughout the stack. After a master is elected, all the stack members compare their current software version with the version that is running on the stack master.

If the comparison process detects differences between software versions, the software version synchronization feature will automatically copy the master's software release onto the appropriate stack members. Once the software release has successfully been copied, this version will become the boot software for that particular stack member, which will then reboot in order to load the new software release.

If a software version running on a stack member is incompatible with that running on the master, and software-auto-synchronization is turned off, then that switch will be removed as a stack member. See [stack software-auto-synchronize command on page 93.33](#).

When auto-synchronization upgrades a stack member, the member's current running software will be set as the backup software release. If there are any problems loading the new software, this backup will be used to recover. If the stack member does not have enough free flash space for the new release, then the new release will replace the oldest release file in flash, which is determined by the oldest software build date. If the current release is the only release file in flash, then the current release will be overwritten.

Autosynchronization Limitations

Because the stack master's software version gets applied to the rest of the stack, care must be taken to ensure the correct switch is elected master. If the master is running an older software release, then software version auto synchronization may actually downgrade the software releases running on other stack members. For configuring which stack member becomes the master, see the [stack priority command on page 93.28](#).

Software auto-synchronization will not work if stack members are booting using either one-off boot or from TFTP or ymodem. In these situations, any stack members running different software will boot as standalone devices.

If software-auto-synchronization is configured as off for a stack member that is running a different software release to the master, by applying the command, **no stack software-auto-synchronize**, then that switch will boot as a standalone device. For more information, see the [stack software-auto-synchronize command on page 93.33](#).

Incompatible Software Releases

The auto-synchronization feature will not always work if there have been significant VCS or system changes between the two different software releases. The VCS discovery of other stack members uses an internal 'stack S/W version' to detect compatibility between builds.

If the VCS software between two stack members is incompatible, the software auto-synchronization feature will not work. Instead, a "incompatible stack S/W version" log message will be displayed and both stack members will boot as standalone devices. This is an undesirable situation because both devices may load the same configuration file, which could cause network conflicts. In order to avoid this situation when upgrading the stack to a new major release, ensure the 'boot system' command succeeds.

In general, the software-auto-synchronize feature will always work between maintenance releases, such as between 5.3.2-0.1 and 5.3.2-0.2, but may not work between major releases that have new VCS features, such as between 5.2.2-0.9 and 5.3.2-0.2.

Upgrading Stack Software Reliably

When upgrading a stack to a new software release, the [boot system command on page 7.5](#) will automatically synchronize the new software release across all stack members. If there is insufficient file space on a backup member, the boot system command has an interactive mode that prompts you to delete old releases to free up file space. However, if you choose not to delete any release files, or if flash space is taken up with other types of files, then the boot system command can fail to set the preferred release on the backup member. If this situation occurs, it is recommended to manually free up file space on the stack member and then reenter the boot system command.

If you are unsure which files to delete, the following process may assist you.

```
awplus# remote-login 2
awplus-2# enable
awplus-2# dir
```

Use the remote-login command to login to the backup member with insufficient free file space, in this example member-2.

Substitute **awplus** for the hostname in the configuration, and use **awplus-3** for stack member-3, and so on.

Look for any .rel (release) files, .jar (GUI), or .tgz and .gz (diagnostic) files that are no longer needed and use the delete command to remove them from the back-up member's file system.

Alternatively, you can use the file system commands directly from the master's console prompt using the filepath of the backup member's flash. Substitute **awplus** for the hostname in the configuration, and use **awplus-3** for stack member-3, and so on.

```
dir awplus-2/flash:*
delete awplus-2/flash:/r1-5.2.1-0.9.rel
```

Chapter 93: Stacking Commands



Introduction.....	93.2
Command List.....	93.3
clear counter stack.....	93.3
debug stack.....	93.4
reboot.....	93.5
reboot rolling.....	93.6
reload.....	93.6
reload rolling.....	93.6
remote-command.....	93.7
remote-login.....	93.9
show counter stack.....	93.9
show debugging stack.....	93.15
show running-config stack.....	93.16
show provisioning (stack-member).....	93.17
show stack.....	93.18
show stack full-debug.....	93.23
stack enable.....	93.24
stack fallback-config (Disabled).....	93.25
stack management subnet.....	93.26
stack management vlan.....	93.27
stack priority.....	93.28
stack renumber.....	93.29
stack renumber cascade.....	93.30
stack resiliencylink.....	93.31
stack software-auto-synchronize.....	93.33
stack virtual-chassis-id.....	93.34
stack virtual-mac.....	93.35
switch provision.....	93.36
switchport resiliencylink.....	93.37
undebg stack.....	93.37

Introduction

This chapter provides an alphabetized reference for each of the Stacking Commands. Also note the following stacking trigger commands that are documented in the Triggers chapter:

[type stack master-fail command on page 87.25](#)
[type stack member command on page 87.26](#)
[type stack link command on page 87.27](#)

In addition to the stacking commands shown in this chapter, stacking content also exists in the following commands:

[hostname command on page 8.17](#)
[reboot command on page 93.5](#)
[show cpu command on page 8.21](#)
[show cpu history command on page 8.25](#)
[show exception log command on page 10.39](#)
[show file systems command on page 7.25](#)
[show memory command on page 8.30](#)
[show memory allocations command on page 8.32](#)
[show memory history command on page 8.34](#)
[show process command on page 8.37](#)
[show running-config stack command on page 93.16](#)
[show system command on page 8.40](#)

Command List

clear counter stack

This command clears all VCStack counters for all stack members.

Syntax `clear counter stack`

Mode Privileged Exec

Example To clear all VC Stack counters:

```
awplus# clear counter stack
```

Related Commands [show counter stack](#)

debug stack

This command enables the Virtual Chassis Stacking (VCS) debugging facilities.

Syntax `debug stack [link|topology|trace]`
`no debug stack [link|topology|trace]`

Parameter	Description
link	Stacking neighbor discovery events on stack links
topology	Stacking topology discovery messages
trace	Notable stacking events

Default Stack trace debugging is enabled.

Mode Privileged Exec and Global Configuration

Usage This command enables the Virtual Chassis Stacking (VCS) debugging facilities. It can only be entered on the stack master.

The command displays debug information about the stacked devices. If no parameter is specified, all the stack debugging information will be displayed, including link events, topology discovery messages and all notable stacking events. If link parameter is specified, only the link events debugging information will be displayed.

Examples To enable debugging, enter the following command on the stack master:

```
awplus# debug stack
```

To enable link debugging, enter the following command on the stack master:

```
awplus# debug stack link
```

To enable topology discovery debugging, enter the following command on the stack master:

```
awplus# debug stack topology
```

To enable stack trace debugging, enter the following command on the stack master:

```
awplus# debug stack trace
```

Related Commands [undebug stack](#)

reboot

This command performs the same function as the [reload command on page 93.6](#).

This command currently halts and performs a cold restart on either the whole stack, or a selected stack member. It performs the same function as the [reboot command on page 93.5](#).

Syntax `reload [stack-member <1-8>]`

Parameter	Description
<code>stack-member</code>	Reload will only operate on a specific stack member
<code><1-8></code>	The ID of the stack member that needs to be reloaded

Mode Privileged Exec

Usage This command currently halts and perform a cold restart on either a specific device or a whole device stack.

For stand alone devices:

Executing this command will reload the device. Before the reload occurs, you will receive a confirmation request saying: "reboot system? (y/n):".

For stacked devices:

To reload a selected device within a stack, you enter the **stack-member** parameter and specify the stack member ID (1 to 8) of the device you want to reboot. Before the reload occurs, you will receive a confirmation request saying: "reboot stack-member <specific stack-member ID> system? (y/n):".

If the specified stack member ID does not exist in the current stack, the command will be rejected.

Executing this command with no parameters specified, will reload all devices in the stack. Before the reload occurs, you will receive a confirmation request saying: "Are you sure you want to reboot the whole stack? (y/n):".

Examples To reload the entire stack:

```
awplus# reload
Are you sure you want to reboot the whole stack? (y/n): y
```

To reload a specific stack member:

```
awplus# reload stack-member 3
reboot stack-member 3 system? (y/n): y
```

Related Commands [reboot](#)

reboot rolling

This command allows a stack to be rebooted in a rolling sequence to minimize downtime.

The stack master is rebooted causing the remaining stack members to failover and elect a new master. The rebooted unit remains separate from the remaining stack and boots up as a stand-alone unit. Once the rebooted unit has finished running its configuration and has brought its ports up, it reboots the remaining stack members

Syntax `reboot rolling`

Mode Privileged Exec

Usage The rolling reboot will only operate when upgrading to a release that also supports rolling reboot.

Note  When VCStack is used with EPSR, the EPSR **failovertime** must be set to at least 5 seconds to avoid any broadcast storms during failover. Broadcast storms may occur if the switch cannot failover quickly enough before the EPSR **failovertime** expires. See the [epsr](#) command for further information about the EPSR **failovertime**.

Examples To rolling reboot the stack, use the following commands:

```
awplus# reboot rolling
```

```
Continue the rolling reboot of the stack? (y/n):
```

After running this command, the stack master will reboot immediately with the configuration file settings. The remaining stack members will then reboot once the master has finished re-configuring.

```
Continue the rolling reboot of the stack? (y/n):
```

```
awplus# y
```

Related Commands [boot system](#)
[epsr](#)

reload

This command performs the same function as the [reboot command on page 93.5](#).

reload rolling

This command performs the same function as the [reboot rolling command on page 93.6](#).

remote-command

Executes a number of host-directed commands that are specific to stack members.

Syntax `remote-command <1-8>`
`show [cpu|counter|file|memory|process|stack|system]`
`clear counter stack`

Parameter	Description
<1-8>	The ID of the stack member where the command should be executed on.
<code>clear counter stack</code>	Can be used on a VCStack master to remotely run the clear counter stack command on page 93.3
<code>cpu</code>	Selects the show cpu command on page 8.21
<code>counter</code>	Selects the show counter stack command on page 93.9
<code>file</code>	Selects the show file command on page 7.24
<code>memory</code>	Selects the show memory command on page 8.30
<code>process</code>	Selects the show process command on page 8.37
<code>stack</code>	Selects the show stack command on page 93.18
<code>system</code>	Selects the show system command on page 8.40
<code>show CPU history</code>	Selects the show cpu history command on page 8.25
<code>show CPU sort pri</code>	Selects the show cpu command on page 8.21 to run with the parameters <code>sort</code> and <code>pri</code> selected.
<code>show CPU sort runtime</code>	Selects the show cpu command on page 8.21 to run with the parameters <code>sort</code> and <code>runtime</code> selected.
<code>show CPU sort sleep</code>	Selects the show cpu command on page 8.21 to run with the parameters <code>sort</code> and <code>pri</code> selected.
<code>show CPU sort thrds</code>	Selects the show cpu command on page 8.21 to run with the parameters <code>sort</code> and <code>thrds</code> selected.
<code>show exception log</code>	Selects the show exception log command on page 10.39
<code>show file systems</code>	Selects the show file systems command on page 7.25
<code>show log permanent</code>	Selects the show file systems command on page 7.25
<code>show log permanent</code>	Selects the show log permanent command on page 10.45
<code>show log permanent tail</code>	Selects the <code>tail</code> parameter of the show log permanent command on page 10.45 command.
<code>show memory</code>	Selects the show memory command on page 8.30 .
<code>show memory history</code>	Selects the <code>history</code> parameter of the show memory command on page 8.30 .

Parameter (cont.)	Description (cont.)
<code>show memory sort peak</code>	Selects the sort and peak parameters of the show memory command on page 8.30 .
<code>show memory sort size</code>	Selects the sort and size parameters of the show memory command on page 8.30 .
<code>show memory sort stk</code>	Selects the sort and stk parameters of the show memory command on page 8.30 .
<code>show process</code>	Selects the show process command on page 8.37 .
<code>show process sort cpu</code>	Selects the sort and cpu parameters of the show process command on page 8.37 .
<code>show process sort mem</code>	Selects the sort and mem parameters of the show process command on page 8.37 .
<code>show stack</code>	Selects the show stack command on page 93.18 .
<code>show stack detail</code>	Selects the details parameter of the show stack command on page 93.18 .
<code>show system</code>	Selects the details parameter of the show stack command on page 93.18 .
<code>show system environment</code>	Selects the show system command on page 8.40 .
<code>show system pluggable</code>	Selects the pluggable parameter of the show system command on page 8.40 .
<code>show system serialnumber</code>	Selects the serialnumber parameter of the show system command on page 8.40 .

Default None

Mode Privileged Exec, and can be also be used in the same mode as the equivalent non-remote command.

Usage This command is used only from the master to execute a command subset that is specific to stack members. If the member ID is not used by any current stack member, the command will be rejected.

Example To execute show system command on stack member 2:

```
awplus# remote-command 2 show system
```

remote-login

This command is used only on the master in order to log onto the CLI of another stack member. In most respects this the result is as if being logged into the stack master. Configuration commands are still applied to all stack members, but show commands, and commands that access the file system are executed locally.

The specific output obtained will vary greatly depending on the show command chosen.

Syntax `remote-login (<1-8>`

Parameter	Description
<1-8>	The specific stack member whose CLI is to be accessed.

Mode Privileged Exec

Usage Note that some commands such as **ping** or **telnet** are not available when the remote-login is used.

Example To log onto stack member 2, use the following command:

```
awplus# remote-login 2
```

To return to the command prompt on the master stack member, type **exit**.

show counter stack

Use this command to display Virtual Chassis Stack (VCStack) related counter information.

Syntax `show counter stack`

Default All counters are reset when the stack member is rebooted.

Mode User Exec and Privileged Exec

Usage If this command is entered on the stack master, it will display all the stacking counter information for every stack member.

When used as a host-directed command, it will display only the stacking counter information for the specific stack member.

Examples To display the stacking counter information about the whole stack, use the following command on the stack master.

```
awplus# show counter stack
```

To display the stacking counter information about stack member 2, use the command:

```
awplus# remote-command 2 show counter stack
```

Figure 93-1: Example output from the `show counter stack` command

```

Virtual Chassis Stacking counters

Stack member 1:

Topology Event counters
Units joined           ..... 1
Units left             ..... 0
Links up               ..... 1
Links down             ..... 0
ID conflict            ..... 0
Master conflict        ..... 0
Master failover        ..... 0
Master elected          ..... 1
Master discovered     ..... 0
SW autoupgrades        ..... 0

Stack Port 1 Topology Event counters
Link up                ..... 3
Link down              ..... 2
Nbr re-init            ..... 0
Nbr incompatible       ..... 0
Nbr 2way comms         ..... 1
Nbr full comms         ..... 1

Stack Port 2 Topology Event counters
Link up                ..... 0
Link down              ..... 0
Nbr re-init            ..... 0
Nbr incompatible       ..... 0
Nbr 2way comms         ..... 0
Nbr full comms         ..... 0

Stack Port 2 Topology Event counters
Link up                ..... 0
Link down              ..... 0
Nbr re-init            ..... 0
Nbr incompatible       ..... 0
Nbr 2way comms         ..... 0
Nbr full comms         ..... 0

Topology Message counters
Tx Total               ..... 4
Tx Hellos               ..... 4
Tx Topo DB              ..... 0
Tx Topo update          ..... 0
Tx Link event           ..... 0
Tx Reinitialise         ..... 0
Tx Port 1               ..... 4
Tx Port 2               ..... 0
Tx 1-hop transport      ..... 4
Tx Layer-2 transport    ..... 0
Rx Total                ..... 1
Rx Hellos                ..... 1
Rx Topo DB              ..... 0
Rx Topo update          ..... 0
Rx Link event           ..... 0
Rx Reinitialise         ..... 0
Rx Port 1               ..... 1
Rx Port 2               ..... 0
Rx 1-hop transport      ..... 1
Rx Layer-2 transport    ..... 0

Topology Error counters
Version unsupported     ..... 0
Product unsupported     ..... 0
XEM unsupported         ..... 0
Too many units          ..... 0
Invalid messages        ..... 0

```

Figure 93-1: Example output from the **show counter stack** command (cont.)

```
Resiliency Link counters
Health status good      ..... 1
Health status bad      ..... 0
Tx                      ..... 0
Tx Error                ..... 0
Rx                      ..... 3600
Rx Error                ..... 0

Stack member 2:

-- Output repeated for other stack members - details not shown--
```

Table 93-1: Parameters in the output of the **show counter stack** command

Parameters	Description
Topology Event Counters	
Units joined	Number of times that the stack acquires a member
Units left	Number of times that the stack loses a member
Links up	Number of times that a stack link is up in the stack
Links down	Number of times that a stack link is down in the stack
ID conflict	Number of times that stack member ID conflicts
Master conflict	Number of times that stack master conflict occurs
Master failover	Number of times that stack master fails
Master elected	Number of times that stack master is elected
Master discovered	Number of times that stack master is discovered
SW autoupgrades	Number of times that the software in the stack members are auto upgraded
Stack port counters	
Link up	Number of times that this unit's physical stack link has come up
Link down	Number of times that this unit's physical stack link has come down
Nbr re-init	Number of times that the neighbour is detected as having reinitialised
Nbr incompatible	Number of times that the neighbour is detected as incompatible
Nbr 2way comms	Number of times that the neighbour is in two way communication status.
Nbr full comms	Number of times that the neighbour is in full communication status.
Topology message counters	
Total	Number of total topology messages
Hellos	Number of hello messages
Topology DB	Number of topology database messages
Topology update	Number of topology database update messages
Link event	Number of link events messages
Reinitialise	Number of reinitialise messages
1-hop transport	Number of 1-hop transport messages
Layer-2 transport	Number of layer 2 transport messages
Link event	Number of link events messages
Reinitialise	Number of reinitialise messages
1-hop transport	Number of 1-hop transport messages
Layer-2 transport	Number of layer 2 transport messages

Table 93-1: Parameters in the output of the **show counter stack** command (cont.)

Parameters	Description
Topology error counters	Reasons why a neighboring unit could not join the stack
Version unsupported	Number of stack software version unsupported errors
Product unsupported	Number of Product unsupported errors
XEM unsupported	Number of XEM unsupported errors
Too many units	Number of too many units errors
Invalid messages	Number of invalid messages
Health status good	The number of times that the resiliency link has successfully carried healthchecks following a failure at startup.
Health status bad	The number of times that the resiliency link healthcheck has timed out. A timeout occurs when a backup stack member detects a delay greater than two seconds between healthcheck messages received.
Rx	The total number of healthcheck messages that a stack member has received from the stack master.
Rx Error	The total number of invalid healthcheck messages that have been received from the master. This message is not applicable to the stack master.

```

Virtual Chassis Stacking counters information

Stack member 1:

Topology Event Counters
-----
Units joined ..... 3      Units left ..... 0
Links up ..... 4         Links down ..... 0
ID conflict ..... 0      Master conflict ..... 0
Master failover ..... 0   Master elected ..... 0
Master discovered ..... 0 SW autoupgrades ..... 0

Stack port 1 Topology Event counters
Link up ..... 1          Link down ..... 0
Nbr re-init ..... 0     Nbr incompatible ... 0
Nbr 2way comms ..... 1  Nbr full comms..... 0

Stack Port 2 Topology Event Counters
Link up ..... 1          Link down ..... 0
Nbr re-init ..... 0     Nbr incompatible ... 0
Nbr 2way comms ..... 1  Nbr full comms..... 0

Topology Message counters
Tx Total ..... 24       Tx Hellos ..... 3
Tx Topo DB..... 2       Tx Topo update..... 2
Tx Link event ..... 0   Tx Reinitialis..... 0
Tx Port 1 ..... 3       Tx Port 2 ..... 1
Tx 1-hop transport .... 4 Tx Layer-2 transport . 20
Rx Total ..... 41       Rx Hellos ..... 3
Rx Topo DB..... 2       Rx Topo update..... 2
Rx Link event ..... 0   Rx Reinitialise ..... 0
Rx Port 1 ..... 1       Rx Port 2 ..... 2
Rx 1-hop transport .... 3 Rx Layer-2 transport . 38

Topology Error counters
Version unsupported ... 0   Product unsupported .. 0
XEM unsupported ..... 0   Too many units ..... 0
Invalid messages ..... 0

Resiliency Link counters
Health status good .... 0   Health status bad ..... 0
Tx ..... 0                 Tx Error ..... 0
Rx ..... 0                 Rx Error..... 0

Stack member 2:
Similar Output

```

Related Commands [show stack](#)

show debugging stack

This command shows which debugging modes are currently enabled for virtual chassis stacking.

Syntax `show debugging stack`

Mode Privileged Exec

Usage To display the stack debugging mode status, use the command:

```
awplus# show debugging stack
```

Figure 93-2: Example output from the show debugging stack command

```
Virtual Chassis Stacking debugging status:  
VCS link debugging is on  
VCS topology debugging is on  
VCS trace debugging is on
```

Example To display the stacking modes status, use the command:

```
awplus# show debugging stack
```

Related Commands [debug stack](#)
[remote-command](#)

show running-config stack

This command displays the running system information specific to the virtual chassis stack.

```
show running-config stack
```

Mode Privileged Exec and Global Configuration

Example To display the stacking running configuration information, use the command:

```
awplus# show running-config stack
```

Output Figure 93-3: Example output from the **show running-config stack** command

```
stack management vlan 4000
stack management subnet 192.168.0.0
stack resiliencylink eth0
no stack 1 software-auto-synchronize
no stack 4 software-auto-synchronize
stack 2 priority 0
```

Related Commands [remote-command](#)
[show running-config](#)

show provisioning (stack-member)

This command shows the provisioning status of all installed or provisioned hardware. Provisioning is the preconfiguration necessary to accommodate future connection of hardware items such as a switch.

Syntax `show provisioning`

Mode Privileged Exec

Example To show provisioning, use the following command:

```
awplus# show provisioning
```

Output Figure 93-4: Example output from the `show provisioning` command

```
Switch provisioning summary information

ID Board class Status
1.0 x600-24      Hardware present
2.0 x600-24      Hardware present
3.0 x600-48      Hardware present
4.0 x600-24      Provisioned

awplus#show provisioning
Switch provisioning summary information

ID Board class Status
1.0 x908         Hardware present
1.1 xem-12       Provisioned
1.4 xem-2        Hardware present
1.5 xem-1        Provisioned
```

Table 93-2: Parameters in the output of the `show provisioning` command

Parameter	Description
ID	The unit.bay-location of the hardware provision
Board class	The hardware type
Status	The provisioned state: <ul style="list-style-type: none"> ■ Hardware Present means that the hardware is currently installed in the stack. ■ Provisioned means that although the hardware is not currently installed; the stack is preconfigured ready to accept the hardware installation.

Related Commands `show stack`
`switch provision`

show stack

Use this command to display information about current stack members.

Syntax `show stack [detail]`

Parameter	Description
detail	Display detailed information.

Default Display summary information only.

Mode User Exec and Privileged Exec

Usage This command displays information about current stack members. If the **detail** parameter is specified, additional information will be displayed for each stack member. By default, only summary information is displayed.

This command can be entered on any stack member as a host-directed command. However, all stack members display the same stacking information.

Examples To display basic information about the stack, use the command:

```
awplus# show stack
```

To display the detailed stacking information about the whole stack:

```
awplus# show stack detail
```

Figure 93-5: Example output from the **show stack** command

```

Virtual Chassis Stacking summary information
ID Pending ID MAC address Priority Status Role
1 - 0000.cd28.07e1 128 Ready Active Master
2 - 0015.77c2.4d44 128 Ready Backup Member
3 - 0015.77c9.7464 128 Syncing Backup Member
4 - - - - - Provisioned

Operational Status Normal operation
Stack MAC address 0000.cd28.07e1

```

Table 93-3: Parameters in the output from the `show stack` command

Parameter	Description
ID	Stack member ID
MAC address	Stack member MAC address
Priority	Stack member master election priority (between 0 and 255) Note that the lowest number has the highest priority.
Role	Stack member's role in the stack, this can be one of: <ul style="list-style-type: none"> ■ Active Master. ■ Disabled Master (The temporary master when there is a communication break within the stack, but communication still exists across the resiliency link. In this state all switch ports within the stack are disabled by default, but a different configuration can be run by a "type stack disabled-master" trigger). ■ Backup Member (A device other than the stack master). ■ Provisioned - Indicates that the stack position is provisionally configured, i.e. ready to accept a particular switch type into the stack.

Figure 93-6: Example output from the `show stack detail` command

```

Virtual Chassis Stacking detailed information

Stack Status:
-----
--
Operational Status           Normal operation
Management VLAN ID          4094
Management VLAN subnet address 192.168.255.0
Virtual Chassis ID           388 (0x184)
Virtual MAC address          0000.cd37.0184

Stack member 1:
-----
--
ID                            1
Pending ID                    -
MAC address                   0000.cd28.070d
Last role change              Wed May 7 22:31:58 2008
Product type                  SwitchBlade x908
SwitchBlade x908 Stacking Ports Disabled (XEM-STK Present)
Role                          Active Master
Priority                       128
Host name                     awplus
S/W version auto synchronizaion On
Resiliency link               Not configured
Port 1.1.1 status             Learnt neighbour 2
Port 1.1.2 status             Learnt neighbour 2

Stack member 2:
-----
--
ID                            2
Pending ID                    -
MAC address                   0000.cd29.716d
Last role change              Wed May 7 23:47:21 2008
Product type                  SwitchBlade x908
SwitchBlade x908 Stacking Ports Disabled (XEM-STK Present)
Role                          Backup Member
Status                        Ready
Priority                       128
Host name                     awplus-2
S/W version auto synchronization On
Resiliency link               Failed
Port stk2.1.1 status          Learnt neighbour 1
Port stk2.1.2 status          Learnt neighbour 1

```

Table 93-4: Parameters in the output from the **show stack detail** command

Parameter	Description
Auto upgrade	Whether the software-auto-configuration feature is turned on, or off.
Host name	The host name of the stack member.
ID	Stack member ID.
Last Role Change	The date and time with the stack member last changed its role in the stack.
MAC address	Stack member MAC address.
Management VLAN ID	The VLAN ID currently used for stack management: Default is 4094.
Management VLAN subnet address	The current stacking management VLAN subnet address.
Operational Status	The status of the stack - either enabled or disabled .
Stack Status	The stack's overall status. Note that a warning is issued if the stack is not connected in a standard ring topology.
Pending ID	The pending stack member ID. This can be changed by the stack renumber command on page 93.29 . If there is no pending ID, the "-" symbol will display.
Port status	The status of the stack port. This can be: <ul style="list-style-type: none"> ■ Down - Neighbour incompatible ■ Discovering neighbour, or Learnt neighbour <neighbor member = ""id>="">
Priority	Stack member master election priority (between 1 and 255) Note that the lowest number has the highest priority.
Product Type	Stack member product type. For example, switchblade x908.
Provisioned	Indicates that the stack position is provisionally configured, i.e. ready to accept a particular switch type into the stack.
Resiliency Link	The current status of the resiliency link. The status can be either: <ul style="list-style-type: none"> ■ 10 - Not configured, (Master or Member) ■ Configured (Master only). ■ Successful or Failed, (Member only).
Role	Stack member's role in the stack, this can be one of: <ul style="list-style-type: none"> ■ Active Master. ■ Disabled Master (The temporary master when there is a communication break within the stack, but communication still exists across the resiliency link. In this state all switch ports within the stack are disabled by default, but a different configuration can be run by a "type stack disabled-master" trigger). ■ Backup Member (a device other than the stack master). ■ Discovering - joining the stack.

Table 93-4: Parameters in the output from the **show stack detail** command (cont.)

Parameter	Description
Status	Indicates how readily a stack member can take over as master if the current stack master were to fail. <ul style="list-style-type: none">■ Init - the stack member is completing the start up initialization.■ Syncing - the stack member is synchronizing state information with the stack master following start up.■ Ready - the stack member is fully synchronized with the current master and is ready to take over immediately.

Related Commands [show counter stack](#)
[stack software-auto-synchronize](#)

show stack full-debug

Displays a detailed history of important debug-level log messages relating to current stack members.

```
show stack full-debug [<stack-member>]
```

Parameter	Description
<stack-member>	The number of a single stack member, in the range 1 to 8.

Default Displays debug information for all stack members.

Mode User Exec and Privileged Exec

Usage This command can be entered on any stack member as a host-directed command. However, all stack members display the same stacking information. Note that this command is provided for AT support staff, and is not intended for general use.

Example To display detailed debug information about stack member 2, use the command:

```
awplus# show stack full-debug 2
```

stack enable

This command is used on a stackable stand-alone switch to manually turn on the virtual chassis stacking feature and XEM-STK links.

By default, the VCS feature starts automatically at the device start-up when XEM-STK is detected.

This command is run on a switch that has previously been removed from the stack (by using the **no** variant of this command) in order to return its stack membership member.

The **no** variant of this command will remove a selected stack member switch from the virtual chassis stack.

Syntax `stack enable`
`no stack <1-8> enable`

Mode Global Configuration

Usage Running the **no** variant of this command will remove the selected stack member from the VCS stack. At this point the removed member will act as a stand alone master and will disable all of its ports. The switch can then only be accessed via its console port.

To return the switch to stack membership, you first run the **stack enable** command. Note that to do this you must direct connectivity via the console port. Then you must run the [reboot command on page 93.5](#). This will reboot the switch and it will re-join the stack as an ordinary member.

If the switch was previously the stack master, you might want to return it to its original stack master status. To do this you must run the [reboot](#) command again. This time - because the switch is now a stack member - the command will reboot the whole stack and generate the master election processes. See the following notes.

Note the following conditions of applying the **no stack <1-8> enable** command:

- If the specified member is a stack master, and no resiliency link is configured, this command will be rejected
- If the specified member ID is not used by any current stack member, the command will be rejected

Caution Disabling a stack member can significantly degrade the throughput capability of the stack.



Example To turn on stacking on a stackable stand-alone unit, use the command:

```
awplus# configure terminal
awplus(config)# stack enable
```

stack fallback-config (Disabled)

This command has been disabled. To simplify stack recovery, stub reconfiguration is now achieved by using a trigger that is generated by the [type stack disabled-master command on page 87.24](#).

This command is used to set the fallback configuration file to use if the stack splits into stubs due to connectivity failures.

Syntax `stack fallback-config <url>`
`no stack fallback-config`

Parameter	Description
<url>	The URL of the stack fallback configuration file.

Mode Global Configuration

Usage This command is used to select the fallback configuration file to be used if a connectivity fault causes the stack splits into stubs. The stack splits into stubs when:

- connectivity is lost between stack members and the stack master across the inter-stack connection.
- the stack master is assumed to be still online, but is no longer reachable by all stack members.

In a stub scenario, the remaining stack members cannot use the same stack configuration, because this will result in potential configuration conflicts, particularly where static channels terminate on different stacking units.

The fallback-config allows the remaining stack members to continue processing network traffic to some degree, without clashing with the existing stack's configuration. Configuring a fallback-configuration also means that the isolated stub members can still be accessible via a management IP address, and so can be re-configured on the fly.

Caution  It is important that any ports that are configured as trunked ports across master and stack members are disabled at their stack member termination when operating in the fallback configuration. Otherwise, the trunked ports will not function correctly on the switch that is connected downstream.

Example

```
awplus# configure terminal
awplus(config)# stack fallback-config flash:/stk_stb.conf
```

Related Commands [stack resiliencylink](#)

stack management subnet

This command configures the stack's VLAN subnet management address.

Use the **no** variant of this command to reset the stack's VLAN subnet management address back to the default address and mask (192.168.255.0/28).

Syntax `stack management subnet <ip-address>`

`no stack management subnet`

Parameter	Description
<code><ip-address></code>	The new subnet address for VCS management VLAN.

Default The default stacking management VLAN subnet address is 192.168.255.0 with a subnet mask 255.255.255.240 or /28.

Mode Global Configuration

Usage This command is used only in the master and configures the stack management VLAN subnet address.

The management VLAN will be used for high speed communication between stacked units via the inter-stack connection. Although this command enables you to change the IP address command, the subnet mask must always remain as shown.

The VCS management IP subnet is solely used internally to the stacked devices, and cannot be reached external to the stack. You should only change the VCS management VLAN subnet address if it causes a conflict within your network.

Note that several separate stacks can use the same default management VLAN subnet address even though their user ports may share the same external network. If the VCS subnet address is changed, then the configuration for any new units must also be updated before they are inserted into the stack.

If the management VLAN subnet address is changed by this command, you can use the **no** variant of this command reset it to its default value.

Example To set the management VLAN subnet address to 192.168.255.144:

```
awplus# configure terminal
awplus(config)# stack management subnet 192.168.255.144
```

Related Commands [stack management vlan](#)

stack management vlan

Use this command to configure the virtual stack management VLAN ID. It can only be entered from the stack master.

Use the **no** variant of this command to change the virtual stack management VLAN ID back to the default (VLAN ID 4094).

Syntax `stack management vlan <2-4094>`
`no stack management vlan <2-4094>`

Parameter	Description
<2-4094>	VCS management VLAN ID. The default is 4094.

Default The default VCS management VLAN ID is 4094

Mode Global Configuration

Usage This command is used only in the master and configures the VCS management VLAN ID.

The management VLAN is used for high speed communication between stacked units via the XEM-STK or the two back panel stacking ports (SwitchBlade® x908 only). This command enables you to change the ID of this VLAN.

The default stacking management VLAN ID is 4094, which is the last configurable VLAN ID in the switch.

The VCS management VLAN is created and configured automatically so that the VCS VLAN cannot be used in the stack's VLAN configuration commands (such as `awplus(config-vlan)# vlan <VCS management VLAN ID>`).

The management VLAN should only be changed if the default VCS VLAN ID needs to be used in the stack's VLAN configuration.

Warning When the command is entered, the updated management VLAN configuration will take effect once the stack is restarted.

If the management VLAN ID is changed by this command, you can use the **no** variant of this command to change it back to default value.

Examples To set the management VLAN to 4000, enter the following commands:

```
awplus# configure terminal
awplus(config)# stack management vlan 4000
```

To reset the management VLAN back to the default (4094), enter the following commands:

```
awplus# configure terminal
awplus(config)# no stack management vlan
```

Related Commands [stack management subnet](#)

stack priority

Use this command to changes a specific stack member's stack ID and its master-election priority.

Syntax `stack <1-8> priority <0-255>`
`no stack <1-8> priority`

Parameter	Description
<1-8>	The ID of the stack member that needs to be configured.
priority	The stack member's election priority value.
<0-255>	The stack member's new priority value. The lowest value is assigned the highest priority. The default is 128.

Mode Global Configuration

Usage This command is used to change the value of a specific stack member's master-election priority. If the specified member ID is not used by any current stack member, the command will be rejected.

The election criteria selects the stack member with the lowest priority value to become the stack master. Where two stack members both have the same lowest priority value, then the stack member with the lowest MAC address will be elected as master.

Note  Assigning a new priority value will not immediately change the current stack master. In order to force a master re-election after the new priority value is assigned, use `reboot stack-member <master's ID>` to reboot the current stack master, a new stack master will then be elected based on the new priority values.

Example To change the priority of stack member 4 to be 2, use the commands:

```
awplus# configure terminal
awplus(config)# stack 4 priority 2
```

Validation Command `show stack`

stack renumber

Use this command to change the ID of a specific stack member.

Syntax `stack <member's-existingID> renumber <member's-newID>`

Parameter	Description
<code><member's-existingID></code>	The the stack member ID to be renumbered - also referred to as the "current member ID". Can have a value in the range 1 to 8. We recommend that you use only numbers 1 & 2
<code>renumber</code>	Change the existing stack member ID.
<code><member's-newID></code>	The stack member's new ID - also referred to as the new member ID. Can have a value in the range 1 to 8. We recommend that you use only numbers 1 & 2 Note that when operating two member stacks, we advise using stack IDs 1 and 2.

Default Every stack unit will initially try to use stack member ID of 1.

Mode Global Configuration

Usage This command is used to change the ID of a specific stack member - primarily when exchanging stack members. The changes made by this command will not take effect until the switch is rebooted.

Note  This command does not alter any of the stacks's existing configuration, apart from the member-ID specified. For example, if stack member 2 were removed from the stack and a new stack unit is assigned the member 2 stack ID then the interface configuration that existed for the removed stack member 2 will be applied to the new stack member 2.

The **current member ID** must already be assigned to an existing stack member. To avoid duplicating IDs, a warning message will appear if you assign a **new member ID** that is currently assigned to another stack member. However, you can continue to rename the stack member IDs and remove ID duplications. If you do not remove the duplications, then the device with the highest root priority will be allocated this ID. Once you have removed any duplicate IDs, you can reboot the switch to implement your changes.

Note that the configured member-ID is saved immediately on the renumbered member, and so is not reliant on using the [copy running-config](#) command for it to take effect

Example To change the stack member ID 2 to be member ID 3, use the commands:

```
awplus# configure terminal
awplus(config)# stack 2 renumber 3
```

Validation Command `show stack`

stack renumber cascade

This command is used to renumber the members of a stack so that their IDs are ordered sequentially, relative to the member's physical position within the stack.



Caution Changing the stack numbering will upset the existing stack member configurations such as port settings etc. This command is intended for use when the stack is either initially commissioned, or has undergone a major reconfiguration. In this situation you run the stack renumber command (which will automatically reboot the switch), then configure the stack members to meet the new requirements.

Syntax `stack <1-8> renumber cascade [<1-8>]`

Parameter	Description
<1-8>	The ID of the stack member to start renumbering from.
renumber	Change the existing stack member ID.
cascade	Renumber the existing stack member ID in cascade order.
<1-8>	The new ID for the first member renumbered.

Default If no member-ID is specified, the member will take the default ID of 1.

Mode Global Configuration

Usage This command is used to renumber the members of a stack so that their member's IDs are ordered sequentially, based on physical order of the XEM-STK connections. This would normally be done either when the stack is initially configured or following a major reconfiguration.

This command is equivalent to pressing and holding the select button on the XEM-STK to renumber the stack members. The renumber will start on the specified stack member. If that member ID is not used by any of the existing stack member, the command will be rejected.

The starting stack member will be renumbered with the new member-ID specified, or the default of member ID of 1. The stack ID of the next physically will be the starting members ID + 1, for example member ID 2. This renumbering will continue in cascading order around the stack members.

The changes will take place immediately and reboot all stack members. For this reason a confirmation prompt follows this command entry, asking whether you are sure you want to renumber and reboot the entire stack.

Example

```
awplus(config)# stack 1 renumber cascade
Any existing interface configuration may no longer be valid
Are you sure you want to renumber and reboot the entire stack?
(y/n): y
```

Related Commands [show stack](#)
[stack renumber](#)

stack resiliencylink

This command configures the resiliency link used by Virtual Chassis Stacking. The interface used may be either an eth0 port or a dedicated VLAN (resiliencylink VLAN) to which switch ports may become members. This VLAN is dedicated to the resiliency link function and must not be the stack management VLAN.

Syntax `stack resiliencylink <interface>`
`no stack resiliencylink`

Parameters	Description
<interface>	The name of the interface that is connected to the resiliency link. This may be either the eth0 port or the resiliencylink VLAN.

Mode Global Configuration

Usage The resiliency-link is only used when a slave loses connectivity with the master via the stacking cables. Such a communication loss would occur if:

- a XEM-STK is removed or fails,
- two or more XEM-STK cables are unplugged or fail,
- the stack master itself fails due to a reboot or power failure.

The resiliency-link allows the slave to determine if the master is still present in the network by the reception of health-check messages sent by the master over the resiliency-link interface.

Reply health-check messages are received if the master is still online, but the stack will now split into two different 'stubs'. The stub containing the existing master will continue operating as normal. The members in the masterless stub will now use a "type stack disabled-master" trigger to run a configuration to form a second temporary stack. This utilizes the remaining stack members' resources without conflicting directly with the master's configuration. If no "type stack disabled-master" trigger was configured on the switches, then the masterless stub members will disable their switch ports.

If no health-check messages are received, then the master is assumed to be completely offline, and so the other stack members can safely take over the master's configuration.



Caution The purpose of the resiliency link is to enable the stack members (particularly the backup master) to check the status of the master under fault conditions. If the resiliency link is not configured, and the master loses communication with its other stack members, then Virtual Chassis Stacking will assume the master is NOT present in the network, which could cause network conflicts if the master is still on line. Note that this is a change to the stacking of releases prior to version 5.3.1.

Example To set the resiliency link to be eth0

```
awplus# configure terminal
awplus(config)# stack resiliencylink eth0
```

Example To set the resiliency link to be VLAN 4093.

First use the [stack resiliencylink](#) command to create the resiliency vlan 4093

```
awplus# configure terminal
awplus(config)# stack resiliencylink vlan4093
```

Next use the [switchport resiliencylink](#) command to assign the resiliencylink vlan to the interface port, in this case port1.0.1.

```
awplus# configure terminal
awplus(config)# interface port1.0.1
awplus(config-if)# switchport resiliencylink
```

Related Commands [show stack](#)

stack software-auto-synchronize

This command is used only on the stack master and enables the software version auto-synchronization feature either on a specified stack member or all stack members and candidates¹.

Use the **no** variant of this command to turn the software version auto synchronization feature off.

1. A stack candidate is a switch that is about to join a stack.

Syntax `stack {all|<1-8>} software-auto-synchronize`
`no stack {all|<1-8>} software-auto-synchronize`

Parameter	Description
all	All stack members.
<1-8>	The ID of a stack member.

Default All the stack members have the stack software-auto-synchronize feature enabled by default.

Mode Global Configuration

Usage This command is used to enable the software version auto-synchronization feature for either a specific stack member or all stack members and candidates.

Note that if a stack candidate attempts to join a stack, but is running a software release that is different to the other stack members, then the software version auto-synchronization feature will copy the master's software release onto the new candidate. If the software version auto-synchronization feature is not enabled, then the candidate will be rejected from the stack.

Note that the software version auto-synchronization feature may also result in the stack candidate downgrading its software release if the master is running an older software version.

Examples To turn on the software-auto-synchronize feature on stack member 2, which was previously turned off, use the following commands:

```
awplus# configure terminal
awplus(config)# stack 2 software-auto-synchronize
```

To turn on the software-auto-synchronize feature for all stack members, which were previously turned off, use the following commands:

```
awplus# configure terminal
awplus(config)# stack all software-auto-synchronize
```

Validation Command `show stack`

stack virtual-chassis-id

This command specifies the VCS virtual chassis ID. The ID selected will determine which virtual MAC address the stack will use. The MAC address assigned to a stack must be unique within its network.

Note The command will not take effect until the switch has been rebooted.



Syntax `stack virtual-chassis-id <id>`

Parameter	Description
<id>	The value of the ID - enter a number in the range 0 to 4095.

Mode Global Configuration

Usage The virtual-chassis-id entered will form the last 12 bits of a pre selected MAC prefix component; that is, 0000.cd37.0xxx. If you enable the VCS virtual MAC address feature (by using the [stack virtual-mac](#) command) without using the [stack virtual-chassis-id](#) command to select the virtual-chassis-id, then the stack will select a virtual-chassis-id from a number within the assigned range.

Example To set the stack virtual-chassis-id to 63 use the commands

```
awplus# configure terminal
awplus(config)# stack virtual-chassis-id 63
```

This will result in a virtual MAC address of: 0000.cd37.003f.

Related Commands [show running-config](#)
[show stack \[detail\]](#)
[stack virtual-mac](#)

stack virtual-mac

This command enables the VCS virtual MAC address feature. For more information on this topic refer to “[Fixed or Virtual MAC Addressing](#)” on page 92.13. With this command set, the value applied for the virtual MAC address is determined by the setting of the command [stack virtual-chassis-id](#) command on page 93.34.

Note This command will not take effect until the switch has been rebooted.



Syntax `stack virtual-mac`
`no stack virtual mac`

Mode Global Configuration

Example

```
awplus# configure terminal
awplus(config)# stack virtual mac
```

Related Commands [show running-config](#)
[show stack \[detail\]](#)
[stack virtual-chassis-id](#)

switch provision

This command enables you provide the configuration for a new VCStack member switch prior to physically connecting it to the stack. To run this command, the stack position must be vacant. The selected hardware type must be compatible existing stack hardware.

Use the **no** variant of this command to remove an existing switch provision.

Syntax `switch <1-8> {provision|reprovision} {x900-12|x900-24|x908}`
`no switch <1-8> provision`

Parameter	Description
<1-8>	The stack member switch position to be provisioned.
provision	Provides settings within the stack configuration ready for a specific switch type to become a stack member.
reprovision	Reconfigure an existing provision configuration.
x900-12	Provision an x900-12switch.
x900-24	Provision an x900-24 switch.
x908	Provision an x908 switch.

Mode Global Configuration

Examples To provision an x600-24 switch as stack member 2, use the following commands:

```
awplus# configure terminal
awplus(config)# switch 2 provision x600-24
```

To reprovision the switch to be an x600-12 switch as stack member 2, use the following commands:

```
awplus# configure terminal
awplus(config)# switch 2 reprovision x600-12
```

To remove the provision of the x600-12 switch as stack member 2, use the following commands:

```
awplus# configure terminal
awplus(config)# no switch 2 provision
```

Related Commands [show provisioning \(stack-member\)](#)

switchport resiliencylink

This command configures the switch port to be a member of the stack resiliency link VLAN. Note that this switchport will only be used for stack resiliency-link traffic and will not perform any other function, or carry any other traffic.

The **no** variant of this command removes the switchport from the resiliency link VLAN.

Syntax `switchport resiliencylink`
`no switchport resiliencylink`

Mode Global Configuration

Examples To set the resiliency link to be VLAN 4093.

First use the [stack resiliencylink](#) command to create the resiliency `vlan4093`

```
awplus# configure terminal
awplus(config)# stack resiliencylink vlan4093
```

Next use the [switchport resiliencylink](#) command to assign the resiliencylink vlan to the interface port, in this case `port1.0.1`.

```
awplus# configure terminal
awplus(config)# interface port1.0.1
awplus(config-if)# switchport resiliencylink
```

undebug stack

This command applies the functionality of the [no debug stack command on page 93.4](#).

Appendix A: Command List

A

aaa accounting auth-mac default.....	59.2
aaa accounting auth-web default.....	59.4
aaa accounting dot1x.....	59.6
aaa accounting login.....	59.8
aaa accounting update.....	59.10
aaa authentication auth-mac.....	59.11
aaa authentication auth-web.....	59.12
aaa authentication dot1x.....	59.13
aaa authentication login.....	59.14
aaa group server.....	59.16
aaa local authentication attempts lockout-time.....	59.17
aaa local authentication attempts max-fail.....	59.18
accept-lifetime.....	32.2
access-group.....	50.4
access-list (extended numbered).....	50.16
access-list (hardware IP numbered).....	50.30
access-list (hardware MAC numbered).....	50.39
access-list (standard numbered) filter.....	50.63
access-list (standard numbered).....	50.59
access-list extended (named).....	50.6
access-list extended ICMP filter.....	50.18
access-list extended IP filter.....	50.20
access-list extended IP protocol filter.....	50.23
access-list extended TCP UDP filter.....	50.27
access-list hardware (named).....	50.41
access-list hardware ICMP filter.....	50.42
access-list hardware IP protocol filter.....	50.45
access-list hardware MAC filter.....	50.51
access-list hardware TCP UDP filter.....	50.54
access-list standard (named) filter.....	50.61
access-list standard (named).....	50.57
accounting login.....	59.19
activate.....	11.2
active (trigger).....	87.2
active (ping polling).....	89.2
address-family.....	38.4
advertisement-interval.....	70.2
aggregate-address (BGP).....	38.5
aggregate-address (RIPng).....	34.2
area authentication.....	36.3
area default-cost.....	36.4
area filter-list.....	36.5
area nssa.....	36.6
area range.....	36.8

area stub.....	36.9
area virtual-link.....	36.10
arp (IP address MAC address)	23.3
arp log.....	23.4
arp security violation.....	68.3
arp security.....	68.2
arp-aging-timeout	23.2
attribute	63.2
auth auth-fail vlan.....	57.3
auth critical	57.5
auth dynamic-vlan-creation.....	57.6
auth guest-vlan.....	57.8
auth host-mode.....	57.10
auth log.....	57.11
auth max-suppliant.....	57.12
auth reauthentication	57.13
auth roaming disconnected	57.14
auth roaming enable.....	57.16
auth supplicant-mac	57.18
auth timeout quiet-period.....	57.20
auth timeout reauth-period.....	57.21
auth timeout server-timeout	57.22
auth timeout supp-timeout	57.23
authentication	63.5
auth-mac enable.....	57.24
auth-mac method.....	57.25
auth-mac reauth-relearning	57.26
auth-web enable	57.27
auth-web forward	57.28
auth-web max-auth-fail	57.30
auth-web method	57.31
auth-web-server dhcp ip address.....	57.32
auth-web-server dhcp lease	57.33
auth-web-server http-redirect	57.34
auth-web-server ipaddress.....	57.35
auth-web-server mode	57.36
auth-web-server ping-poll enable.....	57.38
auth-web-server ping-poll failcount	57.39
auth-web-server ping-poll interval.....	57.40
auth-web-server ping-poll reauth-fresh.....	57.41
auth-web-server ping-poll timeout	57.42
auth-web-server port.....	57.43
auth-web-server redirect-url.....	57.44
auth-web-server session-keep	57.45
auth-web-server ssl	57.45
auth-web-server sslport.....	57.46
auto-cost reference bandwidth.....	36.12
auto-summary	38.7

B

bandwidth.....	36.13
banner exec.....	8.2
banner login (SSH)	66.2
banner login (system)	8.4
banner motd	8.5

bgp aggregate-next-hop-check.....	38.8
bgp always-compare-med.....	38.9
bgp bestpath as-path ignore.....	38.10
bgp bestpath compare-confed-as-path.....	38.10
bgp bestpath compare-routerid.....	38.11
bgp bestpath med remove-recv-med.....	38.14
bgp bestpath med remove-send-med.....	38.14
bgp bestpath med.....	38.12
bgp client-to-client reflection.....	38.15
bgp cluster-id.....	38.16
bgp confederation identifier.....	38.17
bgp confederation peers.....	38.18
bgp config-type.....	38.19
bgp dampening.....	38.20
bgp default ipv4-unicast.....	38.21
bgp default local-preference.....	38.22
bgp deterministic-med.....	38.23
bgp enforce-first-as.....	38.24
bgp fast-external-failover.....	38.25
bgp graceful-restart graceful-reset.....	38.28
bgp graceful-restart.....	38.26
bgp log-neighbor-changes.....	38.29
bgp memory maxallocation.....	38.30
bgp multiple-instance.....	38.31
bgp next-hop-trigger delay.....	38.33
bgp next-hop-trigger enable.....	38.34
bgp next-hop-trigger-count.....	38.32
bgp rfc1771-path-select.....	38.35
bgp rfc1771-strict.....	38.35
bgp router-id.....	38.36
bgp scan-time.....	38.37
bgp update-delay.....	38.38
boot backup.....	7.4
boot config-file.....	7.5
boot system (file-path URL).....	8.6
boot system.....	7.5
bootfile.....	7.6.2

C

capability opaque.....	36.14
capability restart.....	36.15
cd.....	7.6
channel-group mode.....	21.3
circuit-failover.....	70.3
cisco-metric-behavior (RIP).....	32.4
cisco-metric-behavior (RIPng).....	34.3
class.....	53.3
class-map.....	53.4
clear aaa local user lockout.....	59.20
clear arp security statistics.....	68.4
clear arp-cache.....	23.7
clear bgp (ASN).....	38.41
clear bgp (ip address).....	38.40
clear bgp *.....	38.39
clear bgp external.....	38.42

clear bgp peer-group.....	38.43
clear bgp view	38.44
clear counter stack.....	93.3
clear exception log	10.2
clear ip bgp (ASN)	38.49
clear ip bgp (ip address).....	38.46
clear ip bgp *	38.45
clear ip bgp dampening.....	38.47
clear ip bgp external.....	38.51
clear ip bgp flap-statistics.....	38.48
clear ip bgp peer-group	38.52
clear ip bgp view.....	38.54
clear ip dhcp binding	76.3
clear ip dhcp snooping binding.....	68.5
clear ip dhcp snooping statistics.....	68.6
clear ip igmp group	42.3
clear ip igmp interface.....	42.4
clear ip igmp.....	42.2
clear ip mroute statistics.....	43.3
clear ip mroute	43.2
clear ip ospf process.....	36.15
clear ip pim sparse-mode bsr rp-set *	45.2
clear ip prefix-list.....	50.64
clear ip rip route	32.5
clear ipv6 mld group.....	48.3
clear ipv6 mld interface.....	48.3
clear ipv6 mld	48.2
clear ipv6 neighbors.....	25.2
clear ipv6 rip route.....	34.5
clear lacp counters.....	21.2
clear line console	5.2
clear line vty.....	5.2
clear lldp statistics.....	81.2
clear lldp table.....	81.3
clear log buffered.....	10.3
clear log permanent	10.3
clear log.....	10.2
clear loop-protection counters	15.3
clear mac address-table dynamic.....	15.5
clear mac address-table static	15.4
clear mls qos interface policer-counters	53.4
clear ping-poll	89.3
clear port counter	15.6
clear radius local-server statistics.....	63.6
clear spanning-tree detected protocols (RSTP and MSTP).....	19.2
clear ssh.....	66.3
clear test interface.....	13.2
clock set.....	8.7
clock summer-time date.....	8.8
clock summer-time recurring.....	8.10
clock timezone.....	8.12
compatible rfc1583	36.16
configure terminal	4.2
copy (local)	7.8
copy (URL)	7.11
copy current-software	7.6
copy debug	7.7

copy fdb-radius-users (to file)	63.7
copy local-radius-user-db (from file)	63.9
copy local-radius-user-db (to file)	63.10
copy running-config	7.9
copy startup-config	7.10
copy web-auth-https-file	57.47
copy zmodem	7.12
critical-interval	89.4
crypto key destroy hostkey	66.4
crypto key destroy userkey	66.5
crypto key generate hostkey	66.6
crypto key generate userkey	66.7
crypto key pubkey-chain knownhosts	66.8
crypto key pubkey-chain userkey	66.10
crypto pki enroll local local-radius-all-users	63.11
crypto pki enroll local user	63.12
crypto pki enroll local	63.10
crypto pki export local pem	63.13
crypto pki export local pkcs12	63.14
crypto pki trustpoint local	63.15

D

day	87.3
deadtime (RADIUS server group)	61.2
debug aaa	59.21
debug arp security	68.6
debug bgp	38.55
debug crypto	63.16
debug dot1x	55.2
debug epsr	72.2
debug igmp	42.5
debug ip dhcp snooping	68.7
debug ip irdp	23.10
debug ip packet interface	23.8
debug ipv6 rip	34.6
debug lacp	21.5
debug lldp	81.4
debug loopprot	15.6
debug mail	82.2
debug mld	48.4
debug mstp (RSTP and STP)	19.3
debug nsm mcast	43.3
debug nsm packet	8.13
debug nsm	8.13
debug ospf events	36.17
debug ospf ifsm	36.18
debug ospf lsa	36.19
debug ospf nfsm	36.20
debug ospf nsm	36.21
debug ospf packet	36.22
debug ospf route	36.23
debug pim dense-mode all	47.2
debug pim dense-mode context	47.3
debug pim dense-mode decode	47.4
debug pim dense-mode encode	47.4

debug pim dense-mode fsm	47.5
debug pim dense-mode mrt	47.5
debug pim dense-mode nexthop	47.6
debug pim dense-mode nsm	47.7
debug pim dense-mode vif	47.7
debug pim sparse-mode timer	45.4
debug pim sparse-mode	45.3
debug ping-poll	89.5
debug platform packet	15.7
debug radius	61.3
debug rip	32.6
debug sflow agent	91.3
debug sflow	91.2
debug snmp	78.2
debug ssh client	66.11
debug ssh server	66.12
debug stack	93.4
debug trigger	87.4
debug vrrp events	70.4
debug vrrp packet	70.5
debug vrrp	70.4
default log buffered	10.4
default log console	10.4
default log email	10.5
default log host	10.5
default log monitor	10.6
default log permanent	10.7
default-action	53.5
default-information originate (OSPF)	36.24
default-information originate (RIP)	32.7
default-information originate (RIPng)	34.7
default-metric (OSPF)	36.25
default-metric (RIP)	32.8
default-metric (RIPng)	34.7
default-router	76.4
delete debug	7.14
delete mail	82.3
delete	7.13
description (interface)	12.2
description (ping polling)	89.6
description (QOS policy map)	53.6
description (trigger)	87.5
diagnostic monitor pcsping	8.14
dir	7.15
disable (Privileged Exec mode)	4.2
disable (VRRP)	70.5
distance (BGP)	38.56
distance (OSPF)	36.26
distance (RIP)	32.9
distribute-list (OSPF)	36.28
distribute-list (RIP)	32.10
distribute-list (RIPng)	34.9
dns-server	76.5
do	4.3
domain-name	76.6
dot1x control-direction	55.3
dot1x eap	55.4

dot1x eapol-version.....	55.5
dot1x initialize interface.....	55.6
dot1x keytransmit.....	55.7
dot1x max-auth-fail.....	55.8
dot1x max-reauth-req.....	55.9
dot1x port-control.....	55.10
dot1x timeout tx-period.....	55.11
duplex.....	15.9

E

echo.....	11.3
edit URL.....	7.17
edit.....	7.16
egress-rate-limit.....	53.7
egress-vlan-id.....	63.17
egress-vlan-name.....	63.18
enable (Privileged Exec mode).....	4.3
enable (VRRP).....	70.6
enable db-summary-opt.....	36.29
enable password.....	5.3
end.....	4.4
epmr configuration.....	72.4
epmr datavlan.....	72.5
epmr enhancedrecovery enable.....	72.6
epmr mode master controlvlan primaryport.....	72.7
epmr mode transit controlvlan.....	72.8
epmr state.....	72.9
epmr trap.....	72.10
epmr.....	72.3
erase startup-config.....	7.17
erase web-auth-https-file.....	57.47
exception coredump size.....	10.8
exec-timeout.....	5.6
exit.....	4.4
exit-address-family.....	38.57

F

fail-count.....	89.7
flowcontrol.....	15.10

G

group.....	63.20
------------	-------

H

help.....	4.5
host area.....	36.30
host.....	76.7
hostname.....	8.17

I

instance priority (MSTP).....	19.6
instance vlan (MSTP).....	19.8
interface (to configure)	12.3
interface (VRRP)	70.6
interface tunnel.....	27.2
ip address dhcp.....	76.8
ip address.....	23.11
ip as-path access-list.....	38.58
ip community-list expanded.....	38.60
ip community-list standard.....	38.62
ip community-list	38.59
ip dhcp bootp ignore	76.9
ip dhcp option.....	76.10
ip dhcp pool.....	76.12
ip dhcp snooping agent-option allow-untrusted	68.10
ip dhcp snooping agent-option	68.9
ip dhcp snooping binding.....	68.11
ip dhcp snooping database	68.12
ip dhcp snooping delete-by-client.....	68.13
ip dhcp snooping delete-by-linkdown	68.14
ip dhcp snooping max-bindings.....	68.15
ip dhcp snooping subscriber-id.....	68.16
ip dhcp snooping trust.....	68.17
ip dhcp snooping verify mac-address.....	68.18
ip dhcp snooping violation	68.19
ip dhcp snooping	68.8
ip dhcp-relay agent-option checking	76.14
ip dhcp-relay agent-option.....	76.13
ip dhcp-relay information policy	76.15
ip dhcp-relay maxhops.....	76.16
ip dhcp-relay max-message-length	76.17
ip dhcp-relay server-address	76.18
ip directed-broadcast	23.15
ip domain-list.....	23.12
ip domain-lookup	23.13
ip domain-name	23.14
ip extcommunity-list expanded.....	38.64
ip extcommunity-list standard.....	38.66
ip forwarding.....	23.16
ip forward-protocol udp	23.17
ip gratuitous-arp-link	23.19
ip helper-address	23.20
ip igmp access-group.....	42.7
ip igmp immediate-leave	42.8
ip igmp last-member-query-count.....	42.9
ip igmp last-member-query-interval.....	42.10
ip igmp limit	42.11
ip igmp mroute-proxy	42.12
ip igmp proxy-service.....	42.13
ip igmp querier-timeout	42.14
ip igmp query-holdtime.....	42.15
ip igmp query-interval.....	42.17
ip igmp query-max-response-time	42.19
ip igmp ra-option (Router Alert)	42.20

ip igmp robustness-variable	42.20
ip igmp snooping fast-leave	42.22
ip igmp snooping mrouter	42.23
ip igmp snooping querier	42.24
ip igmp snooping report-suppression	42.25
ip igmp snooping routermode	42.26
ip igmp snooping tcn query solicit	42.28
ip igmp snooping	42.21
ip igmp source-address-check	42.29
ip igmp ssm-map enable	42.30
ip igmp ssm-map static	42.30
ip igmp static-group	42.31
ip igmp version	42.32
ip igmp	42.6
ip irdp address preference	23.22
ip irdp broadcast	23.23
ip irdp holdtime	23.24
ip irdp lifetime	23.25
ip irdp maxadvertinterval	23.26
ip irdp minadvertinterval	23.27
ip irdp multicast	23.28
ip irdp preference	23.29
ip irdp	23.21
ip local-proxy-arp	23.30
ip mroute	43.4
ip multicast route-limit	43.5
ip multicast-routing	43.6
ip name-server	23.31
ip ospf authentication	36.31
ip ospf authentication-key	36.32
ip ospf cost	36.33
ip ospf database-filter	36.34
ip ospf dead-interval	36.35
ip ospf disable all	36.36
ip ospf hello-interval	36.37
ip ospf message-digest-key	36.38
ip ospf mtu	36.39
ip ospf mtu-ignore	36.40
ip ospf network	36.41
ip ospf priority	36.42
ip ospf resync-timeout	36.43
ip ospf retransmit-interval	36.44
ip ospf transmit-delay	36.45
ip pim accept-register list	45.6
ip pim anycast-rp	45.7
ip pim bsr-border	45.8
ip pim bsr-candidate	45.9
ip pim cisco-register-checksum group-list	45.10
ip pim cisco-register-checksum	45.9
ip pim crp-cisco-prefix	45.11
ip pim dense-mode passive	47.8
ip pim dense-mode	47.8
ip pim dr-priority	45.12
ip pim exclude-genid	45.13
ip pim hello-holdtime (PIM-DM)	47.9
ip pim hello-holdtime (PIM-SM)	45.14
ip pim hello-interval (PIM-DM)	47.10

ip pim hello-interval (PIM-SM).....	45.15
ip pim ignore-rp-set-priority.....	45.16
ip pim jp-timer.....	45.16
ip pim max-graft-retries.....	47.11
ip pim neighbor-filter (PIM-DM).....	47.12
ip pim neighbor-filter (PIM-SM).....	45.17
ip pim propagation-delay.....	47.13
ip pim register-rate-limit.....	45.18
ip pim register-rp-reachability.....	45.18
ip pim register-source.....	45.19
ip pim register-suppression.....	45.20
ip pim rp-address.....	45.21
ip pim rp-candidate.....	45.23
ip pim rp-register-kat.....	45.24
ip pim sparse-mode passive.....	45.26
ip pim sparse-mode.....	45.25
ip pim spt-threshold group-list.....	45.28
ip pim spt-threshold.....	45.27
ip pim ssm.....	45.29
ip pim state-refresh origination-interval.....	47.14
ip prefix-list.....	50.65
ip proxy-arp.....	23.32
ip radius source-interface.....	61.4
ip redirects.....	23.33
ip rip authentication key-chain.....	32.11
ip rip authentication mode.....	32.14
ip rip authentication string.....	32.18
ip rip receive version.....	32.21
ip rip receive-packet.....	32.20
ip rip send version 1-compatible.....	32.24
ip rip send version.....	32.23
ip rip send-packet.....	32.22
ip rip split-horizon.....	32.25
ip route.....	30.2
ip source binding.....	68.20
ip vrrp authentication mode.....	70.7
ip vrrp authentication string.....	70.8
ipv6 access-list (named).....	51.12
ipv6 access-list extended (named).....	51.3
ipv6 access-list extended IP protocol filter.....	51.7
ipv6 access-list extended TCP UDP filter.....	51.10
ipv6 access-list named ICMP filter.....	51.13
ipv6 access-list named IPv6 protocol filter.....	51.16
ipv6 access-list named TCP UDP filter.....	51.20
ipv6 access-list standard (named).....	51.23
ipv6 access-list standard IPv6 filter.....	51.25
ipv6 address.....	25.2
ipv6 forwarding.....	25.3
ipv6 mld access-group.....	48.5
ipv6 mld limit.....	48.6
ipv6 mld snooping fast-leave.....	48.8
ipv6 mld snooping mrouter.....	48.9
ipv6 mld snooping report-suppression.....	48.10
ipv6 mld snooping.....	48.7
ipv6 mld ssm-map enable.....	48.11
ipv6 mld ssm-map static.....	48.12
ipv6 mld static-group.....	48.13

ipv6 nd managed-config-flag.....	25.4
ipv6 nd other-config-flag.....	25.5
ipv6 nd prefix.....	25.6
ipv6 nd ra-interval.....	25.7
ipv6 nd ra-lifetime.....	25.8
ipv6 nd reachable-time.....	25.9
ipv6 nd suppress-ra.....	25.10
ipv6 neighbor.....	25.11
ipv6 rip split-horizon.....	34.10
ipv6 route.....	25.12
ipv6 router rip.....	34.11
ipv6 traffic-filter.....	51.27
ip (ping polling).....	89.8

J

K

key chain.....	32.27
key.....	32.26
key-string.....	32.28

L

lACP port-priority.....	21.6
lACP system-priority.....	21.6
lACP timeout.....	21.7
lease.....	76.19
length (console display).....	5.7
length (ping poll data).....	89.9
license.....	7.18
line.....	5.8
lldp faststart-count.....	81.5
lldp holdtime-multiplier.....	81.6
lldp management-address.....	81.7
lldp med-notifications.....	81.8
lldp med-tlv-select.....	81.9
lldp non-strict-med-tlv-order-check.....	81.11
lldp notification-interval.....	81.12
lldp notifications.....	81.13
lldp reinit.....	81.14
lldp run.....	81.15
lldp timer.....	81.16
lldp tlv-select.....	81.17
lldp transmit receive.....	81.19
lldp tx-delay.....	81.20
location civic-location configuration.....	81.21
location civic-location identifier.....	81.25
location civic-location-id.....	81.26
location coord-location configuration.....	81.27
location coord-location identifier.....	81.29
location coord-location-id.....	81.30
location elin-location.....	81.31
location elin-location-id.....	81.32
log buffered (filter).....	10.10

log buffered size	10.13
log buffered.....	10.9
log console (filter)	10.15
log console	10.13
log email (filter)	10.19
log email time	10.22
log email.....	10.18
log host (filter).....	10.24
log host time	10.27
log host.....	10.23
log monitor (filter)	10.29
log permanent (filter).....	10.33
log permanent size	10.36
log permanent.....	10.32
login authentication.....	59.22
logout	4.5
log-rate-limit nsm.....	10.37
loop-protection action	15.12
loop-protection timeout	15.13
loop-protection	15.11

M

mac address-table acquire.....	15.13
mac address-table ageing-time	15.14
mac address-table static	15.15
mac address-table thrash-limit	15.16
mail from	82.5
mail smtpserver	82.5
mail	82.4
match access-group.....	53.8
match as-path	40.2
match community	40.4
match cos.....	53.9
match dscp.....	53.10
match inner-cos.....	53.11
match inner-tpid.....	53.12
match inner-vlan.....	53.13
match interface	40.5
match ip address.....	40.6
match ip next-hop	40.8
match ip-precedence	53.14
match ipv6 address.....	40.10
match ipv6 next-hop.....	40.11
match mac-type.....	53.15
match metric	40.12
match origin.....	40.13
match protocol.....	53.16
match route-type.....	40.14
match tag.....	40.15
match tcp-flags.....	53.19
match tpid.....	53.20
match vlan	53.21
max-concurrent-dd	36.46
max-fib-routes.....	8.18
maximum-access-list	50.67

maximum-area.....	36.47
maximum-paths.....	30.3
maximum-prefix.....	32.29
max-static-routes.....	8.19
mirror interface.....	15.17
mkdir.....	7.19
mls qos aggregate-police action.....	53.22
mls qos cos.....	53.24
mls qos enable.....	53.25
mls qos fabric-queue.....	53.26
mls qos map cos-queue to.....	53.28
mls qos map fabric-queue.....	53.29
mls qos map policed-dscp to.....	53.31
mls qos queue.....	53.36
mls qos queue-set averaging-factor.....	53.38
mls qos queue-set description.....	53.40
mls qos queue-set drop-probability.....	53.39
mls qos queue-set threshold.....	53.41
mls qos queue-set.....	53.37
mls qos map premark-dscp to.....	53.33
move debug.....	7.21
move.....	7.20
mtu.....	12.4
multicast.....	43.7

N

nas.....	63.21
neighbor (OSPF).....	36.48
neighbor (RIP).....	32.30
neighbor (RIPng).....	34.12
neighbor activate.....	38.68
neighbor advertisement-interval.....	38.69
neighbor allowas-in.....	38.70
neighbor as-origination-interval.....	38.71
neighbor attribute-unchanged.....	38.72
neighbor capability dynamic.....	38.73
neighbor capability graceful-restart.....	38.74
neighbor capability orf prefix-list.....	38.75
neighbor capability route-refresh.....	38.76
neighbor collide-established.....	38.77
neighbor connection-retry-time.....	38.78
neighbor default-originate.....	38.79
neighbor description.....	38.80
neighbor disallow-infinite-holdtime.....	38.81
neighbor distribute-list.....	38.82
neighbor dont-capability-negotiate.....	38.83
neighbor ebgp-multihop.....	38.84
neighbor enforce-multihop.....	38.85
neighbor filter-list.....	38.86
neighbor interface.....	38.87
neighbor maximum-prefix.....	38.88
neighbor next-hop-self.....	38.89
neighbor override-capability.....	38.90
neighbor passive.....	38.91
neighbor password.....	38.92

neighbor peer-group (adding a neighbor)	38.93
neighbor peer-group (creating a peer-group)	38.94
neighbor port	38.95
neighbor prefix-list	38.96
neighbor remote-as	38.97
neighbor remove-private-AS	38.98
neighbor restart-time	38.99
neighbor route-map	38.100
neighbor route-reflector-client	38.101
neighbor route-server-client	38.102
neighbor send-community	38.103
neighbor shutdown	38.104
neighbor soft-reconfiguration inbound	38.105
neighbor strict-capability-match	38.106
neighbor timers	38.107
neighbor transparent-as	38.108
neighbor transparent-nexthop	38.109
neighbor unsuppress-map	38.110
neighbor update-source	38.111
neighbor version	38.112
neighbor weight	38.113
network (BGP)	38.114
network (DHCP)	76.20
network (RIP)	32.31
network area	36.49
network synchronization	38.115
next-server	76.21
no debug all	8.18
no police	53.42
normal-interval	89.10
ntp access-group	74.2
ntp authenticate	74.3
ntp authentication-key	74.4
ntp broadcastdelay	74.5
ntp master	74.6
ntp peer	74.7
ntp server	74.8
ntp trusted-key	74.9

O

offset-list (RIP)	32.32
offset-list (RIPng)	34.13
optimistic-nd	23.34
option	76.22
ospf abr-type	36.50
ospf restart grace-period	36.51
ospf restart helper	36.52
ospf router-id	36.53
overflow database external	36.55
overflow database	36.54

P

passive-interface (OSPF)	36.56
passive-interface (RIP)	32.33

passive-interface (RIPng)	34.14
ping ipv6	25.13
ping	23.35
ping-poll	89.11
platform bist	15.18
platform control-plane-prioritization rate.....	15.19
platform delay-locked-loop-monitoring.....	15.21
platform enhancedmode.....	15.22
platform jumboframe	15.24
platform load-balancing.....	15.25
platform portstorm	15.26
platform prbs	15.27
platform routingratio	15.28
platform vlan-stacking-tpid	15.29
polarity.....	15.30
police aggregate.....	53.43
police single-rate action	53.44
police twin-rate action drop-red	53.46
policy-map	53.48
preempt-mode	70.9
priority	70.10
priority-queue.....	53.48
private-vlan association	17.3
private-vlan.....	17.2
privilege level.....	5.8
pwd.....	7.21

Q

R

radius-server deadtime.....	61.5
radius-server host.....	61.6
radius-server key.....	61.9
radius-server local	63.22
radius-server retransmit.....	61.10
radius-server timeout.....	61.11
range.....	76.24
reboot rolling.....	93.6
reboot.....	93.5
recv-buffer-size (RIP).....	32.34
recv-buffer-size (RIPng).....	34.15
redistribute (OSPF).....	36.57
redistribute (RIP)	32.35
redistribute (RIPng)	34.16
redistribute route-map.....	38.116
region (MSTP).....	19.9
reload rolling.....	93.6
reload	93.6
remote-command.....	93.7
remote-login.....	93.9
repeat	87.6
restart bgp graceful.....	38.117
restart ospf graceful.....	36.58
restart rip graceful.....	32.36
revision (MSTP).....	19.10

rip restart grace-period	32.36
rmdir	7.22
rmon alarm.....	84.3
rmon collection history	84.5
rmon collection stats.....	84.6
rmon event	84.7
route (RIP).....	32.37
route (RIPng)	34.17
route-map.....	40.16
router bgp view.....	38.119
router bgp.....	38.118
router ip irdp	23.36
router ipv6 rip	34.18
router ospf	36.59
router rip.....	32.38
router vrrp.....	70.11
router-id.....	36.60

S

sample-size	89.12
script	87.7
security-password forced-change.....	5.10
security-password history	5.9
security-password lifetime	5.11
security-password minimum-categories	5.12
security-password minimum-length	5.13
security-password reject-expired-pwd	5.14
security-password warning.....	5.15
send-lifetime	32.39
server (Server Group).....	61.13
server auth-port	63.23
server enable.....	63.24
service advanced-vty.....	5.16
service dhcp-relay.....	76.25
service dhcp-server	76.26
service dhcp-snooping.....	68.21
service http.....	5.17
service password-encryption	5.18
service ssh.....	66.13
service telnet.....	5.19
service terminal-length	5.20
service test	13.3
service-policy input.....	53.49
set aggregator	40.18
set as-path	40.19
set atomic-aggregate.....	40.20
set bandwidth-class.....	53.50
set comm-list delete	40.21
set community.....	40.22
set cos.....	53.51
set dampening.....	40.24
set dscp	53.52
set extcommunity	40.26
set ip next-hop (PBR)	53.53
set ip next-hop (route map).....	40.27

set ipv6 next-hop	40.28
set local-preference.....	40.29
set metric	40.30
set metric-type.....	40.31
set origin.....	40.32
set originator-id	40.33
set queue	53.54
set tag.....	40.34
set weight.....	40.35
sflow agent (address)	91.4
sflow collector (address).....	91.5
sflow collector max-datagram-size.....	91.6
sflow enable.....	91.7
sflow max-header-size	91.8
sflow polling-interval	91.10
sflow sampling-rate.....	91.11
show access-group	50.68
show access-list	50.69
show arp security interface.....	68.24
show arp security statistics.....	68.25
show arp security	68.23
show arp.....	23.37
show auth-mac diagnostics.....	57.49
show auth-mac interface.....	57.50
show auth-mac sessionstatistics	57.52
show auth-mac statistics interface	57.53
show auth-mac supplicant interface	57.55
show auth-mac supplicant	57.54
show auth-mac	57.48
show auth-web diagnostics.....	57.57
show auth-web interface	57.58
show auth-web sessionstatistics.....	57.60
show auth-web statistics interface.....	57.61
show auth-web supplicant interface.....	57.63
show auth-web supplicant	57.62
show auth-web.....	57.56
show auth-web-server.....	57.64
show banner login.....	66.14
show bgp memory maxallocation	38.120
show bgp nexthop-tracking.....	38.120
show bgp nexthop-tree-details	38.120
show boot	7.23
show class-map.....	53.55
show cli	4.6
show clock.....	8.20
show counter dhcp-client.....	76.27
show counter dhcp-relay.....	76.28
show counter dhcp-server.....	76.30
show counter log.....	10.38
show counter mail	82.6
show counter ntp.....	74.10
show counter ping-poll.....	89.13
show counter snmp-server.....	78.3
show counter stack.....	93.9
show cpu history	8.25
show cpu.....	8.21
show crypto key hostkey.....	66.15

show crypto key pubkey-chain knownhosts.....	66.16
show crypto key pubkey-chain userkey	66.17
show crypto key userkey	66.18
show crypto pki certificates local-radius-all-users	63.27
show crypto pki certificates user	63.28
show crypto pki certificates.....	63.25
show crypto pki trustpoints.....	63.29
show debugging aaa.....	59.23
show debugging arp security	68.27
show debugging bgp.....	38.121
show debugging dot1x.....	55.12
show debugging epsr.....	72.10
show debugging igmp	42.33
show debugging ip dhcp snooping.....	68.27
show debugging ip packet.....	23.38
show debugging ipv6 rip	34.18
show debugging lacp	21.8
show debugging lldp.....	81.33
show debugging loopprot	15.30
show debugging mstp.....	19.11
show debugging nsm.....	8.28
show debugging ospf.....	36.60
show debugging pim dense-mode	47.14
show debugging pim sparse-mode	45.30
show debugging platform packet	15.31
show debugging radius.....	61.15
show debugging rip	32.40
show debugging sflow.....	91.12
show debugging snmp.....	78.6
show debugging stack.....	93.15
show debugging vrrp.....	70.11
show debugging.....	8.27
show dhcp lease.....	76.31
show diagnostic monitor pcsping.....	8.29
show dot1x diagnostics	55.15
show dot1x interface	55.16
show dot1x sessionstatistics.....	55.21
show dot1x statistics interface.....	55.22
show dot1x supplicant interface.....	55.25
show dot1x supplicant	55.23
show dot1x.....	55.13
show epsr counters.....	72.12
show epsr word counters	72.12
show epsr word.....	72.11
show epsr	72.11
show etherchannel detail.....	21.10
show etherchannel summary.....	21.11
show etherchannel	21.9
show exception log.....	10.39
show file systems.....	7.25
show file.....	7.24
show flowcontrol interface.....	15.32
show history	4.6
show hosts	23.39
show interface access-group.....	50.71
show interface brief	12.9
show interface status.....	12.10

show interface switchport.....	15.32
show interface.....	12.6
show ip access-list.....	50.72
show ip bgp attribute-info.....	38.123
show ip bgp cidr-only.....	38.124
show ip bgp community.....	38.125
show ip bgp community-info.....	38.126
show ip bgp community-list.....	38.126
show ip bgp dampening.....	38.127
show ip bgp filter-list.....	38.128
show ip bgp inconsistent-as.....	38.129
show ip bgp longer-prefixes.....	38.130
show ip bgp neighbors connection-retrytime.....	38.132
show ip bgp neighbors hold-time.....	38.133
show ip bgp neighbors keepalive.....	38.133
show ip bgp neighbors keepalive-interval.....	38.134
show ip bgp neighbors notification.....	38.134
show ip bgp neighbors open.....	38.135
show ip bgp neighbors rcvd-msgs.....	38.135
show ip bgp neighbors sent-msgs.....	38.136
show ip bgp neighbors update.....	38.136
show ip bgp neighbors.....	38.131
show ip bgp paths.....	38.137
show ip bgp prefix-list.....	38.137
show ip bgp quote-regexp.....	38.138
show ip bgp regexp.....	38.138
show ip bgp route-map.....	38.139
show ip bgp scan.....	38.139
show ip bgp summary.....	38.140
show ip bgp view neighbors.....	38.142
show ip bgp view summary.....	38.143
show ip bgp view.....	38.141
show ip bgp.....	38.122
show ip community-list.....	38.144
show ip dhcp binding.....	76.33
show ip dhcp pool.....	76.34
show ip dhcp server statistics.....	76.38
show ip dhcp snooping acl.....	68.29
show ip dhcp snooping binding.....	68.31
show ip dhcp snooping interface.....	68.32
show ip dhcp snooping statistics.....	68.33
show ip dhcp snooping.....	68.28
show ip dhcp-relay.....	76.37
show ip dhcp server summary.....	76.39
show ip domain-list.....	23.40
show ip domain-name.....	23.40
show ip extcommunity-list.....	38.144
show ip forwarding.....	23.41
show ip igmp groups.....	42.34
show ip igmp interface.....	42.35
show ip igmp snooping mrouter.....	42.38
show ip igmp snooping routermode.....	42.39
show ip igmp snooping statistics.....	42.40
show ip interface brief.....	23.42
show ip irdp interface.....	23.44
show ip irdp.....	23.43
show ip mroute.....	43.8

show ip mvif	43.10
show ip name-server	23.46
show ip ospf border-routers	36.63
show ip ospf database asbr-summary	36.65
show ip ospf database external.....	36.66
show ip ospf database network.....	36.67
show ip ospf database nssa-external.....	36.69
show ip ospf database opaque-area.....	36.71
show ip ospf database opaque-as.....	36.72
show ip ospf database opaque-link.....	36.73
show ip ospf database router.....	36.74
show ip ospf database summary	36.76
show ip ospf database	36.64
show ip ospf interface.....	36.78
show ip ospf neighbor	36.79
show ip ospf route	36.81
show ip ospf virtual-links	36.82
show ip ospf.....	36.61
show ip pim dense-mode interface detail.....	47.17
show ip pim dense-mode interface	47.15
show ip pim dense-mode mroute.....	47.18
show ip pim dense-mode neighbor detail	47.20
show ip pim dense-mode neighbor.....	47.19
show ip pim dense-mode nexthop	47.21
show ip pim sparse-mode bsr-router.....	45.30
show ip pim sparse-mode interface detail.....	45.33
show ip pim sparse-mode interface	45.31
show ip pim sparse-mode mroute detail	45.36
show ip pim sparse-mode mroute.....	45.34
show ip pim sparse-mode neighbor.....	45.38
show ip pim sparse-mode nexthop.....	45.39
show ip pim sparse-mode rp mapping	45.41
show ip pim sparse-mode rp-hash.....	45.40
show ip prefix-list.....	50.73
show ip protocols bgp.....	38.145
show ip protocols ospf	36.83
show ip protocols rip.....	32.40
show ip rip database.....	32.41
show ip rip interface.....	32.42
show ip rip.....	32.41
show ip route database	30.6
show ip route summary.....	30.7
show ip route	30.4
show ip rpf	43.11
show ip source binding	68.36
show ipv6 access-list.....	51.29
show ipv6 forwarding	25.14
show ipv6 interface brief.....	25.15
show ipv6 mld groups	48.15
show ipv6 mld interface	48.16
show ipv6 mld snooping mrouter	48.17
show ipv6 mld snooping statistics.....	48.18
show ipv6 neighbors.....	25.15
show ipv6 protocols rip.....	34.19
show ipv6 rip database	34.21
show ipv6 rip interface.....	34.22
show ipv6 rip	34.20

show ipv6 route summary	25.17
show ipv6 route.....	25.16
show lacp sys-id.....	21.12
show lacp-counter	21.12
show license	7.27
show list.....	4.7
show lldp interface	81.35
show lldp local-info	81.37
show lldp neighbors detail	81.43
show lldp neighbors.....	81.41
show lldp statistics interface.....	81.48
show lldp statistics	81.46
show lldp.....	81.34
show location	81.50
show log config.....	10.42
show log permanent.....	10.45
show log	10.40
show loop-protection.....	15.33
show mac address-table thrash-limit.....	15.35
show mac address-table.....	15.34
show mail.....	82.6
show memory allocations.....	8.32
show memory history.....	8.34
show memory pools.....	8.36
show memory	8.30
show mirror interface	15.37
show mirror.....	15.36
show mls qos aggregate-policer.....	53.56
show mls qos fabric-queue.....	53.57
show mls qos interface policer-counters.....	53.59
show mls qos interface queue-counters.....	53.60
show mls qos interface storm-status	53.62
show mls qos interface	53.57
show mls qos maps cos-queue	53.63
show mls qos maps fabric-queue.....	53.64
show mls qos maps policed-dscp	53.65
show mls qos maps premark-dscp.....	53.66
show mls qos queue-set	53.66
show nsm client.....	8.37
show ntp associations.....	74.11
show ntp status	74.12
show ping-poll.....	89.15
show platform bist.....	15.39
show platform classifier statistics utilization brief.....	15.40
show platform counter ipv4.....	15.42
show platform full debug.....	15.43
show platform port	15.44
show platform portstorm.....	15.47
show platform prbs.....	15.48
show platform register	15.49
show platform swtable.....	15.50
show platform table.....	15.51
show platform	15.38
show policy-map.....	53.69
show port etherchannel.....	21.13
show port-security interface	15.52
show port-security intrusion	15.53

show privilege.....	5.22
show process.....	8.37
show provisioning (stack-member).....	93.17
show provisioning (xem-bay).....	15.54
show radius local-server group.....	63.30
show radius local-server nas.....	63.31
show radius local-server statistics.....	63.32
show radius local-server user.....	63.33
show radius statistics.....	61.18
show radius.....	61.16
show rmon alarm.....	84.8
show rmon event.....	84.9
show rmon history.....	84.10
show rmon statistics.....	84.12
show route-map.....	40.36
show router-id.....	8.39
show running-config access-list.....	7.31
show running-config as-path access-list.....	7.32
show running-config bgp.....	7.33
show running-config community-list.....	7.34
show running-config dhcp.....	7.35
show running-config full.....	7.36
show running-config interface.....	7.37
show running-config ip pim dense-mode.....	7.40
show running-config ip pim sparse-mode.....	7.40
show running-config ip route.....	7.41
show running-config ipv6 access-list.....	7.41
show running-config ipv6 mroute.....	7.42
show running-config ipv6 prefix-list.....	7.43
show running-config ipv6 route.....	7.44
show running-config key chain.....	7.45
show running-config lldp.....	7.46
show running-config log.....	10.48
show running-config prefix-list.....	7.47
show running-config route-map.....	7.48
show running-config router vrrp.....	70.12
show running-config router.....	7.49
show running-config router-id.....	7.50
show running-config security-password.....	7.51
show running-config sflow.....	91.13
show running-config snmp.....	78.6
show running-config ssh.....	66.19
show running-config stack.....	93.16
show running-config switch lacp.....	7.53
show running-config switch radius-server.....	7.53
show running-config switch vlan.....	7.54
show running-config switch.....	7.52
show running-config trigger.....	87.8
show running-config.....	7.29
show security-password configuration.....	5.21
show security-password user.....	5.21
show sflow interface.....	91.15
show sflow.....	91.14
show snmp-server community.....	78.7
show snmp-server group.....	78.8
show snmp-server user.....	78.8
show snmp-server view.....	78.9

show snmp-server.....	78.7
show spanning-tree (brief).....	19.15
show spanning-tree mst config.....	19.17
show spanning-tree mst detail interface.....	19.20
show spanning-tree mst detail.....	19.18
show spanning-tree mst instance interface.....	19.23
show spanning-tree mst instance.....	19.22
show spanning-tree mst interface.....	19.24
show spanning-tree mst.....	19.16
show spanning-tree.....	19.12
show ssh client.....	66.21
show ssh server allow-users.....	66.23
show ssh server deny-users.....	66.24
show ssh server.....	66.22
show ssh.....	66.20
show stack full-debug.....	93.23
show stack.....	93.18
show startup-config.....	7.55
show static-channel-group.....	21.14
show storm-control.....	15.55
show system environment.....	8.42
show system interrupts.....	8.43
show system pci device.....	8.44
show system pci tree.....	8.45
show system pluggable detail.....	8.47
show system pluggable.....	8.46
show system psu.....	8.49
show system serialnumber.....	8.51
show system.....	8.40
show tech-support.....	8.52
show telnet.....	5.22
show trigger.....	87.9
show users.....	5.23
show version.....	7.56
show vlan classifier group.....	17.5
show vlan classifier interface group.....	17.5
show vlan classifier rule.....	17.6
show vlan private-vlan.....	17.6
show vlan.....	17.4
show vrrp (session).....	70.13
show vrrp.....	70.12
shutdown.....	12.12
snmp trap link-status suppress.....	78.11
snmp trap link-status.....	78.10
snmp-server community.....	78.14
snmp-server contact.....	78.15
snmp-server enable trap.....	78.16
snmp-server engineID local.....	78.18
snmp-server group.....	78.19
snmp-server host.....	78.20
snmp-server location.....	78.22
snmp-server source-interface.....	78.23
snmp-server user.....	78.24
snmp-server view.....	78.26
snmp-server.....	78.13
source-ip.....	89.19
spanning-tree autoedge (RSTP and MSTP).....	19.25

spanning-tree cisco-interoperability (MSTP).....	19.26
spanning-tree edgeport (RSTP and MSTP).....	19.27
spanning-tree enable.....	19.28
spanning-tree errdisable-timeout enable.....	19.29
spanning-tree errdisable-timeout interval.....	19.30
spanning-tree force-version.....	19.31
spanning-tree forward-time.....	19.32
spanning-tree guard root.....	19.33
spanning-tree hello-time.....	19.34
spanning-tree link-type.....	19.35
spanning-tree max-age.....	19.36
spanning-tree max-hops (MSTP).....	19.37
spanning-tree mode.....	19.38
spanning-tree mst configuration.....	19.38
spanning-tree mst instance path-cost.....	19.40
spanning-tree mst instance priority.....	19.41
spanning-tree mst instance.....	19.39
spanning-tree path-cost.....	19.42
spanning-tree portfast (STP).....	19.43
spanning-tree portfast bpdu-filter.....	19.45
spanning-tree portfast bpdu-guard.....	19.47
spanning-tree priority (bridge priority).....	19.48
spanning-tree priority (port priority).....	19.49
spanning-tree transmit-holdcount.....	19.50
speed (async).....	8.55
speed.....	15.56
ssh client.....	66.27
ssh server allow-users.....	66.31
ssh server authentication.....	66.33
ssh server deny-users.....	66.34
ssh server scp.....	66.35
ssh server sftp.....	66.36
ssh server.....	66.29
ssh.....	66.25
stack enable.....	93.24
stack fallback-config (Disabled).....	93.25
stack management subnet.....	93.26
stack management vlan.....	93.27
stack priority.....	93.28
stack renumber cascade.....	93.30
stack renumber.....	93.29
stack resiliencylink.....	93.31
stack software-auto-synchronize.....	93.33
stack virtual-chassis-id.....	93.34
stack virtual-mac.....	93.35
static-channel-group.....	21.15
storm-action.....	53.70
storm-control level.....	15.58
storm-downtime.....	53.71
storm-protection.....	53.72
storm-rate.....	53.73
storm-window.....	53.74
subnet-mask.....	76.40
summary-address.....	36.84
switch bay provision.....	15.59
switch provision.....	93.36
switchport access vlan.....	17.7

switchport enable vlan.....	17.8
switchport mode access.....	17.9
switchport mode private-vlan	17.10
switchport mode trunk	17.11
switchport port-security aging.....	15.60
switchport port-security maximum.....	15.61
switchport port-security violation.....	15.62
switchport port-security.....	15.60
switchport private-vlan host-association.....	17.12
switchport private-vlan mapping	17.13
switchport resiliencylink.....	93.37
switchport trunk allowed vlan.....	17.14
switchport trunk native vlan.....	17.16
switchport vlan-stacking (double tagging)	17.17
switchport voice dscp.....	17.18
switchport voice vlan priority.....	17.21
switchport voice vlan	17.19
synchronization.....	38.146
system territory.....	8.56

T

tcpdump	23.47
telnet server	5.25
telnet.....	5.24
terminal length	5.26
terminal monitor.....	8.57
test interface.....	13.4
test	87.13
thrash-limiting	15.63
time (trigger).....	87.14
timeout (ping polling).....	89.20
timers (BGP)	38.147
timers (RIP).....	32.43
timers (RIPng).....	34.23
timers spf exp.....	36.86
timers spf.....	36.85
traceroute ipv6	25.18
traceroute	23.47
trap	87.16
trigger activate.....	87.18
trigger	87.17
trust dscp (XEM-2XP).....	53.76
trust dscp.....	53.75
tunnel dscp.....	27.3
tunnel mode ipv6ip	27.4
tunnel source	27.5
tunnel ttl	27.6
type cpu.....	87.19
type interface	87.20
type memory	87.21
type periodic.....	87.22
type ping-poll.....	87.23
type reboot.....	87.23
type stack disabled-master.....	87.24
type stack link	87.27

type stack master-fail.....	87.25
type stack member.....	87.26
type time.....	87.28

U

undebug aaa.....	59.23
undebug all pim dense-mode.....	47.22
undebug all pim sparse-mode.....	45.41
undebug all.....	8.57
undebug bgp.....	38.148
undebug dot1x.....	55.26
undebug epsr.....	72.12
undebug igmp.....	42.40
undebug ip irdp.....	23.48
undebug ip packet interface.....	23.48
undebug ipv6 rip.....	34.24
undebug lacp.....	21.16
undebug loopprot.....	15.64
undebug mail.....	82.7
undebug mstp.....	19.50
undebug nsm packet.....	8.58
undebug nsm.....	8.57
undebug ospf events.....	36.87
undebug ospf ifsm.....	36.87
undebug ospf lsa.....	36.87
undebug ospf nfsm.....	36.87
undebug ospf nsm.....	36.87
undebug ospf packet.....	36.87
undebug ospf route.....	36.87
undebug ping-poll.....	89.21
undebug platform packet.....	15.64
undebug radius.....	61.18
undebug rip.....	32.44
undebug sflow.....	91.15
undebug snmp.....	78.26
undebug ssh client.....	66.36
undebug ssh server.....	66.36
undebug stack.....	93.37
undebug trigger.....	87.28
undebug vrrp events.....	70.14
undebug vrrp packet.....	70.14
undebug vrrp.....	70.14
up-count.....	89.21
user (RADIUS server).....	63.35
username.....	5.27

V

version.....	32.45
virtual-ip.....	70.15
vlan (RADIUS server).....	63.37
vlan classifier activate.....	17.23
vlan classifier group.....	17.24
vlan classifier rule ipv4.....	17.25
vlan classifier rule proto.....	17.26

vlan database.....	17.28
vlan.....	17.22
vrrp vmac	70.15

W

wait	11.4
write file.....	7.57
write memory.....	7.57
write terminal	7.57
wrr-queue disable queues.....	53.77
wrr-queue egress-rate-limit queues.....	53.78
wrr-queue group weight queues.....	53.79
wrr-queue queue-limit.....	53.80

X

Y

Z

Appendix B: Changes in Version 5.3.4-0.1

This appendix lists the changes made in Software Version 5.3.4-0.1.

- [New or Changed Features \(Table B-1 on page B.1\)](#)
- [New or Changed Commands: \(Table B-2 on page B.3\)](#)
- [New or Changed SNMP MIBs: \(Table B-3 on page B.17\)](#)

Clicking on a topic in the Feature column will take you to the appropriate section of the manual.

Table B-1: New or Changed Features

Feature	Status	Chapter / Section	Description
How to Set Strong Passwords	Feature	Getting Started	Use the password security rules to specify a password lifetime, force a user to change an expired password at the next login, specify that a user is not allowed to login with an expired password, set the number of previous passwords unable to be reused, and specify password minimum length and categories.
ARP Logging	Feature	Internet Protocol (IP) Addressing and Protocols	You can enable your device to log static and dynamic ARP entries, and you can select either default hexadecimal notation (HHHH.HHHH.HHHH) or standard IEEE format hexadecimal notation (HH-HH-HH-HH-HH-HH) for the MAC addresses displayed in the ARP log output.
BGP Authentication	Feature	BGP Configuration	BGP authentication allows users to receive selected routing information, enhancing security of their network traffic. When BGP authentication is enabled on a peer, the peer verifies routing packet it receives by exchanging a password that is configured on both the sending and the receiving peers.
Configuring BGP Graceful Reset	Feature	BGP Configuration	The graceful restart feature for BGP session reset is used so that any changes in network configuration do not affect packet forwarding. The graceful restart feature invokes graceful restart only when a configuration change forces a peer reset.
Configuring BGP Graceful Restart	Feature	BGP Configuration	Using BGP graceful restart, the data forwarding plane of the device can continue to process and forward packets even if the control plane, which is responsible for determining best paths, fails

Table B-1: New or Changed Features (cont.)

Feature	Status	Chapter / Section	Description
ACL Sequence Number Support	Feature	Access Control Lists Introduction	To help you manage ACLs you can apply sequence numbers to filters. This allows you to remove filters from named and numbered ACLs without having to reconfigure an ACL. The ability to add sequence numbers to filters simplifies updates through the ability to position a filter within an ACL. When you add a new filter, you can specify a sequence number to position the filter in the ACL and you can also remove a current filter in an ACL by specifying a sequence number.
Authentication Enhancements	Feature	Authentication Configuration	The authentication enhancements introduced in this release fall into three areas: improvements to Web-authentication, increased flexibility in the operation of the Guest VLAN, and introduction of the auth-fail VLAN.
Web-authentication Enhancements	Feature	Authentication Configuration	These enhancements ensure that the client PC user is presented with the Web-authentication login page as soon as they start web browsing to any address, irrespective of the IP configuration on their PC.
Guest VLAN Enhancements	Feature	Authentication Configuration	Guest VLAN enhancements now allow routing from the Guest VLAN to route unauthenticated supplicant's traffic to other VLANs if required, and will relay their DHCP requests to servers in other VLANs if required.
Failed authentication VLAN	Feature	Authentication Configuration	The auth-fail VLAN feature allows the Network Administrator to separate the supplicants who attempted authentication, but failed, from the supplicants who did not attempt authentication.
DHCP Snooping	Feature	DHCP Snooping Introduction	DHCP snooping can be used to increase network security and traceability by filtering traffic according to valid DHCP leases. DHCP snooping on the switch supports traffic filtering, DHCP Option 82, ARP security, and MAC address verification.
sFlow Introduction	Feature	sFlow Introduction	sFlow®1 provides the ability to monitor traffic in data networks containing switches and routers. This feature adds the sFlow Agent capability.

Table B-2: New or Changed Commands

Command	Status	Chapter / Section	Description
How to Set Strong Passwords	New	Getting Started	Use the password security rules to specify a password lifetime, force a user to change an expired password at the next login, specify that a user is not allowed to login with an expired password, set the number of previous passwords unable to be reused, and specify password minimum length and categories.
ARP Logging	New	Internet Protocol (IP) Addressing and Protocols	You can enable your device to log static and dynamic ARP entries, and you can select either default hexadecimal notation (HHHH.HHHH.HHHH) or standard IEEE format hexadecimal notation (HH-HH-HH-HH-HH-HH) for the MAC addresses displayed in the ARP log output.
BGP Authentication	New	BGP Configuration	BGP authentication allows users to receive selected routing information, enhancing security of their network traffic. When BGP authentication is enabled on a peer, the peer verifies routing packet it receives by exchanging a password that is configured on both the sending and the receiving peers.
Configuring BGP Graceful Reset	New	BGP Configuration	The graceful restart feature for BGP session reset is used so that any changes in network configuration do not affect packet forwarding. The graceful restart feature invokes graceful restart only when a configuration change forces a peer reset.
Configuring BGP Graceful Restart	New	BGP Configuration	Using BGP graceful restart, the data forwarding plane of the device can continue to process and forward packets even if the control plane, which is responsible for determining best paths, fails
ACL Sequence Number Support	New	Access Control Lists Introduction	To help you manage ACLs you can apply sequence numbers to filters. This allows you to remove filters from named and numbered ACLs without having to reconfigure an ACL. The ability to add sequence numbers to filters simplifies updates through the ability to position a filter within an ACL. When you add a new filter, you can specify a sequence number to position the filter in the ACL and you can also remove a current filter in an ACL by specifying a sequence number.
Authentication Enhancements	New	Authentication Configuration	The authentication enhancements introduced in this release fall into three areas: improvements to Web-authentication, increased flexibility in the operation of the Guest VLAN, and introduction of the auth-fail VLAN.
Web-authentication Enhancements	New	Authentication Configuration	These enhancements ensure that the client PC user is presented with the Web-authentication login page as soon as they start web browsing to any address, irrespective of the IP configuration on their PC.

Table B-2: New or Changed Commands (cont.)

Command	Status	Chapter / Section	Description
Guest VLAN Enhancements	New	Authentication Configuration	Guest VLAN enhancements now allow routing from the Guest VLAN to route unauthenticated supplicant's traffic to other VLANs if required, and will relay their DHCP requests to servers in other VLANs if required.
Failed authentication VLAN	New	Authentication Configuration	The auth-fail VLAN feature allows the Network Administrator to separate the supplicants who attempted authentication, but failed, from the supplicants who did not attempt authentication.
DHCP Snooping	New	DHCP Snooping Introduction	DHCP snooping can be used to increase network security and traceability by filtering traffic according to valid DHCP leases. DHCP snooping on the switch supports traffic filtering, DHCP Option 82, ARP security, and MAC address verification.
sFlow Introduction	New	sFlow Introduction	sFlow®1 provides the ability to monitor traffic in data networks containing switches and routers. This feature adds the sFlow Agent capability.
security-password history	New	User Access Commands	This command specifies the number of previous passwords that are unable to be reused.
security-password forced-change	New	User Access Commands	This command specifies whether or not a user is forced to change an expired password at the next login.
security-password lifetime	New	User Access Commands	This command enables password expiry by specifying a password lifetime in days.
security-password minimum-categories	New	User Access Commands	This command configures the minimum number of categories that the password must satisfy to be considered valid.
security-password minimum-length	New	User Access Commands	This command configures the minimum allowable password length.
security-password reject-expired-pwd	New	User Access Commands	This command specifies whether or not a user is allowed to login with an expired password.
security-password warning	New	User Access Commands	This command specifies the number of days before the password expires that the user will receive a warning message specifying the remaining lifetime of the password.
show security-password configuration	New	User Access Commands	This command displays the configuration settings for the various security password rules.
show security-password user	New	User Access Commands	This command displays user account and password information for all users
show running-config security-password	New	File Management Commands	This command displays the configuration settings for the various security-password rules.
boot system (file-path URL)	New	System Configuration and Monitoring Commands	This command specifies the release file that will load during the next boot cycle. The specified file must exist and be stored in the root directory of the flash filesystem.

Table B-2: New or Changed Commands (cont.)

Command	Status	Chapter / Section	Description
<code>diagnostic monitor pcsping</code>	New	System Configuration and Monitoring Commands	Use this command to disable or configure the background PCS (Physical Coding Sublayer) ping monitoring feature to either output a log message or to power off a XEM when a background PCS ping check fails. The background PCS ping feature is enabled by default to output log messages.
<code>show debugging</code>	New	System Configuration and Monitoring Commands	This command displays information for all debugging options.
<code>show diagnostic monitor pcsping</code>	New	System Configuration and Monitoring Commands	Use this command show the status of the background PCS (Physical Coding Sublayer) ping feature used to the check the link status between a XEM and the switch.
<code>speed (async)</code>	New	System Configuration and Monitoring Commands	This command changes the console speed from the switch.
<code>log-rate-limit nsm</code>	New	Logging Commands	This command limits the number of log messages generated by the switch. The log rate limiting feature resolves the issue of the switch memory becoming overloaded, which may cause the switch to shutdown, when a packet storm occurs, because of a network loop generating too many log messages too frequently for memory.
<code>debug loopprot</code>	New	Switching Commands	This command enables Loop Protection debugging.
<code>show debugging loopprot</code>	New	Switching Commands	This command shows Loop Protection debugging information.
<code>show debugging platform packet</code>	New	Switching Commands	This command shows platform to CPU level packet debugging information.
<code>show platform full debug</code>	New	Switching Commands	This command displays low-level system information and diagnostics.
<code>show provisioning (xem-bay)</code>	New	Switching Commands	This command shows the provisioning status of all installed or provisioned hardware.
<code>arp log</code>	New	IP Addressing and Protocol Commands	This command enables and disables the logging of dynamic and static ARP entries in the ARP cache. This command can display the MAC addresses in the ARP log either using the default hexadecimal notation (HHHH.HHHH.HHHH), or using the standard IEEE format notation (HH-HH-HH-HH-HH-HH).
<code>ip redirects</code>	New	IP Addressing and Protocol Commands	This command enables and disables ICMP redirects for an interface. ICMP redirects are enabled by default.
<code>cisco-metric-behavior (RIP)</code>	New	RIP Commands	Use this command to enable or disable the RIP routing metric update to conform to Cisco's implementation. The Cisco implementation sets the metric of redistributed connected and static RIP routes to 0 by default. AlliedWare Plus sets this metric to 1 by default when using the default-metric command.

Table B-2: New or Changed Commands (cont.)

Command	Status	Chapter / Section	Description
<code>cisco-metric-behavior (RIPng)</code>	New	RIPng Commands	Use this command to enable or disable the RIPng routing metric update to conform to Cisco's implementation. The Cisco implementation sets the metric of redistributed connected and static RIPng routes to 0 by default. AlliedWare Plus sets this metric to 1 by default when using the <code>default-metric</code> command.
<code>enable db-summary-opt</code>	New	OSPF Commands	This command enables OSPF database summary list optimization.
<code>timers spf exp</code>	New	OSPF Commands	Use this command to adjust route calculation timers using exponential back-off delays.
<code>bgp bestpath med remove-recv-med</code>	New	BGP Commands	This command removes the Multi Exit Discriminator (MED) attribute from the update messages received by the BGP speaker from its peers.
<code>bgp bestpath med remove-send-med</code>	New	BGP Commands	This command removes the Multi Exit Discriminator (MED) attribute from the update messages sent by the BGP speaker from its peers.
<code>bgp graceful-restart graceful-reset</code>	New	BGP Commands	This command enables BGP graceful-restart when a configuration change forces a peer restart.
<code>bgp nexthop-trigger-count</code>	New	BGP Commands	This command configures the display of BGP nexthop-tracking status.
<code>bgp nexthop-trigger delay</code>	New	BGP Commands	This command sets the delay interval for nexthop address tracking.
<code>bgp nexthop-trigger enable</code>	New	BGP Commands	This command enables nexthop address tracking.
<code>neighbor connection-retry-time</code>	New	BGP Commands	This command sets the connection retry time for a specific BGP neighbor.
<code>neighbor disallow-infinite-holdtime</code>	New	BGP Commands	Use this command to disallow the configuration of infinite holdtime.
<code>neighbor password</code>	New	BGP Commands	Use this command to enable MD5 authentication on a TCP connection between BGP neighbors.
<code>show bgp nexthop-tracking</code>	New	BGP Commands	This command displays BGP nexthop-tracking status.
<code>show bgp nexthop-tree-details</code>	New	BGP Commands	This command displays BGP nexthop-tree-details.
<code>show ip bgp neighbors connection-retrytime</code>	New	BGP Commands	This command displays the configured connection-retrytime value of the peer at the session establishment time with the neighbor.
<code>show ip bgp neighbors hold-time</code>	New	BGP Commands	This command displays the configured holdtime value of the peer at the session establishment time with the neighbor.

Table B-2: New or Changed Commands (cont.)

Command	Status	Chapter / Section	Description
<code>show ip bgp neighbors keepalive</code>	New	BGP Commands	This command displays the number of keepalive messages sent to the neighbor from the peer throughout the session.
<code>show ip bgp neighbors keepalive-interval</code>	New	BGP Commands	This command displays the configured keepalive-interval value of the peer at the session establishment time with the neighbor.
<code>show ip bgp neighbors notification</code>	New	BGP Commands	This command displays the number of notification messages sent to the neighbor from the peer throughout the session.
<code>show ip bgp neighbors open</code>	New	BGP Commands	This command displays the number of open messages sent to the neighbor from the peer throughout the session.
<code>show ip bgp neighbors rcvd-msgs</code>	New	BGP Commands	This command displays the number of messages received by the neighbor from the peer throughout the session.
<code>show ip bgp neighbors sent-msgs</code>	New	BGP Commands	This command displays the number of messages sent to the neighbor from the peer throughout the session.
<code>show ip bgp neighbors update</code>	New	BGP Commands	This command displays the number of update messages sent to the neighbor from the peer throughout the session.
<code>access-group</code>	New	IPv4 Access Control List (ACL) Commands	This new command replaces the existing ip access group and mac access group commands. This command adds (or removes) a hardware-based numbered or named access-list to a switch port interface. This command works in both Global Configuration and Interface Configuration modes to apply hardware access-lists to all switch port interfaces or selected switch port interfaces respectively.
<code>access-list extended ICMP filter</code>	New	IPv4 Access Control List (ACL) Commands	Use this ACL filter to add a new ICMP filter entry to the current extended access-list. If the sequence number is specified, the new filter is inserted at the specified location. Otherwise, the new filter is added at the end of the access-list.
<code>access-list extended IP filter</code>	New	IPv4 Access Control List (ACL) Commands	Use this ACL filter to add a new IP filter entry to the current extended access-list. If the sequence number is specified, the new filter is inserted at the specified location. Otherwise, the new filter is added at the end of the access-list.
<code>access-list extended IP protocol filter</code>	New	IPv4 Access Control List (ACL) Commands	Use this ACL filter to add a new IP protocol type filter entry to the current extended access-list. If the sequence number is specified, the new filter is inserted at the specified location. Otherwise, the new filter is added at the end of the access-list.

Table B-2: New or Changed Commands (cont.)

Command	Status	Chapter / Section	Description
access-list extended TCP UDP filter	New	IPv4 Access Control List (ACL) Commands	Use this ACL filter to add a new TCP or UDP filter entry to the current extended access-list. If the sequence number is specified, the new filter is inserted at the specified location. Otherwise, the new filter is added at the end of the access-list.
access-list hardware (named)	New	IPv4 Access Control List (ACL) Commands	This command creates a named hardware access-list that can be applied to a switch port interface. ACL filters for a named hardware ACL are created in the IPv4 Hardware ACL Configuration mode. The no variant of this command removes the specified named hardware ACL.
access-list hardware ICMP filter	New	IPv4 Access Control List (ACL) Commands	Use this ACL filter to add a new ICMP filter entry to the current hardware access-list. If a sequence number is specified, the new filter is inserted at the specified location. Otherwise, the new filter is added at the end of the access-list.
access-list hardware IP protocol filter	New	IPv4 Access Control List (ACL) Commands	Use this ACL filter to add an IP protocol type filter entry to the current hardware access-list. If a sequence number is specified, the new filter is inserted at the specified location. Otherwise, the new filter is added at the end of the access-list.
access-list hardware MAC filter	New	IPv4 Access Control List (ACL) Commands	Use this ACL filter to add a MAC filter entry to the current hardware access-list. If a sequence number is specified, the new filter is inserted at the specified location. Otherwise, the new filter is added at the end of the access-list.
access-list hardware TCP UDP filter	New	IPv4 Access Control List (ACL) Commands	Use this ACL filter to add a TCP or UDP filter entry to the current hardware access-list. The filter will match on any TCP or UDP type packet that has the specified source and destination IP addresses. The parameter any may be specified if an address does not matter. If a sequence number is specified, the new filter is inserted at the specified location. Otherwise, the new filter is added at the end of the access-list.
access-list standard (named) filter	New	IPv4 Access Control List (ACL) Commands	This ACL filter adds a source IP address filter entry to a current standard access-list. If the sequence number is specified, the new filter entry will be inserted at the specified location. Otherwise, the new entry is added at the end of the access-list.
access-list (standard numbered) filter	New	IPv4 Access Control List (ACL) Commands	This ACL filter adds a source IP address filter entry to a current standard numbered access-list. If a sequence number is specified, the new filter entry is inserted at the specified location. Otherwise, the new filter entry is added at the end of the access-list.

Table B-2: New or Changed Commands (cont.)

Command	Status	Chapter / Section	Description
ipv6 access-list extended IP protocol filter	New	IPv6 Access Control List (ACL) Commands	Use this ACL filter to add a filter entry for an IPv6 source and destination address and prefix, with or without an IP protocol specified, to the current extended IPv6 access-list. If a sequence number is specified, the new entry is inserted at the specified location. Otherwise, the new entry is added at the end of the access-list.
ipv6 access-list extended TCP UDP filter	New	IPv6 Access Control List (ACL) Commands	Use this ACL filter to add a filter entry for an IPv6 source and destination address and prefix, with a TCP (Transmission Control Protocol) or UDP (User Datagram Protocol) source and destination port specified, to the current extended IPv6 access-list. If a sequence number is specified, the new entry is inserted at the specified location. Otherwise, the new entry is added at the end of the access-list.
ipv6 access-list standard IPv6 filter	New	IPv6 Access Control List (ACL) Commands	Use this ACL filter to add a filter entry for an IPv6 source address and prefix length to the current standard IPv6 access-list. If a sequence number is specified, the new entry is inserted at the specified location. Otherwise, the new entry is added at the end of the access-list.
dot1x max-auth-fail	New	802.1X Commands	Use this command to configure the maximum number of login attempts for a supplicant (client device) using the auth-fail vlan feature, when using 802.1X port authentication on an interface.
auth auth-fail vlan	New	Authentication Commands	Use this command to enable the auth-fail vlan feature on the specified vlan interface. This feature assigns supplicants (client devices), which have failed port authentication, to the specified vlan interface.
auth log	New	Authentication Commands	Use this command to configure the types of authentication feature log messages that are output to the log file.
auth-web-server dhcp ip address	New	Authentication Commands	Use this command to assign an IP address and enable the DHCP service on the web authentication server for supplicants (client devices).
auth-web-server dhcp lease	New	Authentication Commands	Use this command to set the DHCP lease time for supplicants (client devices) using the DHCP service on the web authentication server.
auth-web-server mode	New	Authentication Commands	Use this command to configure the mode (from the intercept, none, or promiscuous modes available) on the Web-authentication server for supplicants (client devices).
arp security	New	DHCP Snooping Commands	Use this command to enable ARP security on VLANs.
arp security violation	New	DHCP Snooping Commands	Use this command to specify the action to take if an ARP security violation is detected on the ports.

Table B-2: New or Changed Commands (cont.)

Command	Status	Chapter / Section	Description
<code>clear arp security statistics</code>	New	DHCP Snooping Commands	Use this command to clear ARP security statistics for the specified ports, or for all ports.
<code>clear ip dhcp snooping binding</code>	New	DHCP Snooping Commands	Use this command to remove dynamic entries from the DHCP snooping database.
<code>clear ip dhcp snooping statistics</code>	New	DHCP Snooping Commands	Use this command to clear DHCP Snooping statistics for the specified ports, or for all ports.
<code>debug arp security</code>	New	DHCP Snooping Commands	Use this command to enable ARP security debugging.
<code>debug ip dhcp snooping</code>	New	DHCP Snooping Commands	Use this command to enable debugging for DHCP snooping.
<code>ip dhcp snooping</code>	New	DHCP Snooping Commands	Use this command to enable DHCP snooping on VLANs.
<code>ip dhcp snooping agent-option</code>	New	DHCP Snooping Commands	Use this command to enable DHCP Option 82 data insertion on the switch.
<code>ip dhcp snooping agent-option allow-untrusted</code>	New	DHCP Snooping Commands	Use this command to enable DHCP Option 82 reception on untrusted ports.
<code>ip dhcp snooping binding</code>	New	DHCP Snooping Commands	Use this command to manually add a dynamic-like entry (with an expiry time) to the DHCP snooping binding database.
<code>ip dhcp snooping database</code>	New	DHCP Snooping Commands	Use this command to set the location of the DHCP snooping database backup file.
<code>ip dhcp snooping delete-by-client</code>	New	DHCP Snooping Commands	Use this command to set the switch to remove a dynamic entry from the DHCP snooping database when it receives a valid DHCP release message for it.
<code>ip dhcp snooping delete-by-linkdown</code>	New	DHCP Snooping Commands	Use this command to set the switch to remove a dynamic entry from the DHCP snooping database when its port goes down.
<code>ip dhcp snooping max-bindings</code>	New	DHCP Snooping Commands	Use this command to set the maximum number of lease entries that can be stored in the DHCP snooping binding database for each of the ports.
<code>ip dhcp snooping subscriber-id</code>	New	DHCP Snooping Commands	Use this command to set a subscriber ID for the ports.
<code>ip dhcp snooping trust</code>	New	DHCP Snooping Commands	Use this command to set the ports to be DHCP snooping trusted ports.
<code>ip dhcp snooping verify mac-address</code>	New	DHCP Snooping Commands	Use this command to verify that the source MAC address and client hardware address match in DHCP packets on untrusted ports.
<code>ip dhcp snooping violation</code>	New	DHCP Snooping Commands	Use this command to specify the action the switch will take when it detects a DHCP snooping violation on the ports.
<code>ip source binding</code>	New	DHCP Snooping Commands	Use this command to add a static entry to the DHCP snooping database.
<code>service dhcp-snooping</code>	New	DHCP Snooping Commands	Use this command to enable DHCP snooping on the switch.
<code>show arp security</code>	New	DHCP Snooping Commands	Use this command to display ARP security configuration on the switch.

Table B-2: New or Changed Commands (cont.)

Command	Status	Chapter / Section	Description
<code>show arp security interface</code>	New	DHCP Snooping Commands	Use this command to display ARP security configuration for ports.
<code>show arp security statistics</code>	New	DHCP Snooping Commands	Use this command to display ARP security statistics.
<code>show debugging arp security</code>	New	DHCP Snooping Commands	Use this command to display the ARP security debugging configuration.
<code>show debugging ip dhcp snooping</code>	New	DHCP Snooping Commands	Use this command to display the DHCP snooping debugging configuration.
<code>show ip dhcp snooping</code>	New	DHCP Snooping Commands	Use this command to display DHCP snooping global configuration on the switch.
<code>show ip dhcp snooping acl</code>	New	DHCP Snooping Commands	Use this command to display information about the access lists using DHCP snooping.
<code>show ip dhcp snooping binding</code>	New	DHCP Snooping Commands	Use this command to display all dynamic and static entries in the DHCP snooping binding database.
<code>show ip dhcp snooping interface</code>	New	DHCP Snooping Commands	Use this command to display information about DHCP snooping configuration and leases for specified ports, or all ports.
<code>show ip dhcp snooping statistics</code>	New	DHCP Snooping Commands	Use this command to display DHCP snooping statistics.
<code>show ip source binding</code>	New	DHCP Snooping Commands	Use this command to display static entries in the DHCP snooping database.
<code>clear ip dhcp binding</code>	New	Dynamic Host Configuration Protocol (DHCP) Commands	On dynamically allocated bindings this command clears either a specific lease binding, or the lease bindings specified by the command.
<code>type stack disabled-master</code>	New	Trigger Commands	This command (configured to the stack) selects a pre-configured trigger that will activate on a stack member if it becomes the disabled master.
<code>debug sflow</code>	New	sFlow Commands	This command enables sFlow® debug message logging, for sFlow sampling and polling activity on the specified ports. If no ports are specified, sampling and/or polling debug messages are enabled for all ports.
<code>debug sflow agent</code>	New	sFlow Commands	This command enables sFlow® debug message logging that is not specific to particular ports. For example, sending an sFlow datagram to the collector.
<code>sflow agent (address)</code>	New	sFlow Commands	This command sets the sFlow® agent IP address on the switch. This address is inserted into every sFlow datagram sent from the sFlow agent switch, to the sFlow collector device. The sFlow collector then use this address for SNMP to uniquely identify and access the switch.
<code>sflow collector (address)</code>	New	sFlow Commands	This command sets the sFlow® agent's collector IP address and/or UDP port. This is the destination IP address and UDP port, for sFlow datagrams sent from the sFlow agent. The IP address can be any valid IPv4 or IPv6 address.

Table B-2: New or Changed Commands (cont.)

Command	Status	Chapter / Section	Description
<code>sflow collector max-datagram-size</code>	New	sFlow Commands	This command sets the maximum size of the sFlow® datagrams sent to the collector.
<code>sflow enable</code>	New	sFlow Commands	This command enables sFlow® globally on the switch. Note that sFlow cannot be enabled if Tx port mirroring is enabled on any port on the device.
<code>sflow max-header-size</code>	New	sFlow Commands	This command sets the maximum header size of the ethernet frames sampled on a specified port. The maximum header size is measured in bytes, referenced from the first byte of the ethernet destination address and excludes the ethernet FCS fields.
<code>sflow polling-interval</code>	New	sFlow Commands	This command sets the sFlow® counter polling interval (in seconds) for the specified ports. A value of 0 disables polling. A counter sample is taken every N seconds where N is the value set by this command.
<code>sflow sampling-rate</code>	New	sFlow Commands	This command sets the mean sFlow® sampling rate for the specified ports. Sampling occurs every N frames (on average), where N is the rate value set via this command. The sampling rate applies to ingress and egress frames independently.
<code>show debugging sflow</code>	New	sFlow Commands	This command displays sFlow® debug settings for agent operation, and for sampling and polling on specific interface ports. If no interface ports are specified, sampling and polling will be applied to all ports.
<code>show running-config sflow</code>	New	sFlow Commands	This command displays the running system information specific to the sFlow feature.
<code>show sflow</code>	New	sFlow Commands	This command displays non-port-specific sFlow agent configuration and operational status.
<code>show sflow interface</code>	New	sFlow Commands	This command displays sFlow agent sampling and polling configuration for specified ports.
<code>undebg sflow</code>	New	sFlow Commands	This command applies the functionality of the no debug sflow command.
<code>reboot rolling</code>	New	Stacking Commands	This command allows a stack to be rebooted in a rolling sequence to minimize downtime. The stack master is rebooted causing the remaining stack members to failover and elect a new master.
<code>reload rolling</code>	New	Stacking Commands	This command performs the same function as the reboot rolling command.
<code>remote-login</code>	New	Stacking Commands	This command is used only on the master in order to log onto the CLI of another stack member. In most respects this the result is as if being logged into the stack master. Config commands are still broadcast to all stack members, but show commands, and commands that access the file system are executed locally.

Table B-2: New or Changed Commands (cont.)

Command	Status	Chapter / Section	Description
<code>show provisioning (stack-member)</code>	New	Stacking Commands	This command shows the provisioning status of all installed or provisioned hardware.
<code>switch provision</code>	New	Stacking Commands	This command enables you provide the configuration for a new VCStack member switch prior to physically connecting it to the stack. To run this command, the stack position must be vacant. The selected hardware type must be compatible existing stack hardware.
<code>mtu</code>	Modified	Interface Commands	The MTU (Maximum Transmission Unit) size for VLANs specified by this command has changed from <64-9208> bytes to <68-1500> bytes. The negated form of this command will restore the default MTU size of 1500 bytes for VLANs.
<code>show interface brief</code>	Modified	Interface Commands	This command displays brief interface, configuration, and status information, including provisioning information.
<code>debug platform packet</code>	Modified	Switching Commands	The sflow parameter option has been added to the debug platform packet command to display only sFlow packets when enabled. The vlan parameter option has also been added to the debug platform packet command to limit debug to a single VLAN ID specified when enabled.
<code>platform enhancedmode</code>	Modified	Switching Commands	This command rearranges memory in the silicon so that it can store a greater than usual number of QoS traffic class counters, QoS Policers, or nexthop routes. For the enhanced mode to take effect, you must restart the device after entering this command. The qospolicers parameter has been added.
<code>platform portstorm</code>	Modified	Switching Commands	This command performs a port storm on the system. This test generates a high packet load on switch ports, exercising the packet data path and front-panel ports.
<code>platform prbs</code>	Modified	Switching Commands	This command performs a PRBS (Pseudo-Random Bit Stream) test on the switch. You can now specify whether to test either the internal fabric links or the stacking fabric links (x908 only), or both.
<code>platform routingratio</code>	Modified	Switching Commands	This command changes the amount of memory allocated to IPv4 routing tables relative to IPv6 routing tables. The default routing memory ratio is now set to <code>ipv4andipv6</code> allowing both IPv4 and IPv6 to run concurrently.
<code>platform vlan-stacking-tpid</code>	Modified	Switching Commands	The no platform vlan-stacking-tpid command has been added to revert to the default TPID (Tag Protocol Identifier) value of 0x8100.
<code>show platform portstorm</code>	Modified	Switching Commands	This command displays the result of a previously run port storm test on the switch.

Table B-2: New or Changed Commands (cont.)

Command	Status	Chapter / Section	Description
<code>channel-group mode</code>	Modified	Link Aggregation Commands	With this command you add a switch port to a dynamic channel group specified by the channel group number. You can now create 32 channel groups with a base license, consisting of a combination of static and dynamic channel groups. With a feature license you can create 128 channel groups, consisting of a maximum of 32 dynamic channel groups and a maximum of 96 static channel groups.
<code>static-channel-group</code>	Modified	Link Aggregation Commands	With this command you can create a static channel group, or add a member port to an already existing static channel group. You can now create 32 channel groups with a base license, consisting of a combination of static and dynamic channel groups. With a feature license you can create 128 channel groups, consisting of a maximum of 96 static channel groups and a maximum of 32 dynamic channel groups.
<code>network area</code>	Modified	OSPF Commands	Use this command to enable OSPF routing with a specified Area ID on interfaces with IP addresses that match the specified network address.
<code>passive-interface (OSPF)</code>	Modified	OSPF Commands	Use this command to suppress the sending of Hello packets on all interfaces, or on a specified interface. If you use the passive-interface command without the optional parameters then all interfaces are put into passive mode.
<code>bgp multiple-instance</code>	Modified	BGP Commands	This command enables the BGP multiple instance support. You now have the option to activate the same peer in multiple BGP views.
<code>timers (BGP)</code>	Modified	BGP Commands	This command sets the BGP keepalive timer and holdtime timer values. The default keepalive value has changed from 60 to 30 seconds and the default holdtime value has changed from 180 to 90 seconds.
<code>show ip pim sparse-mode interface</code>	Modified	PIM-SM Commands	The output displayed by this command has changed. A maximum of 100 interfaces are available. The show output will display the number of interfaces that can be configured in the "maximum allowed" field.
<code>show ip pim dense-mode interface</code>	Modified	PIM-DM Commands	The output displayed by this command has changed. A maximum of 100 interfaces are available. The show output will display the number of interfaces that can be configured in the "maximum allowed" field.

Table B-2: New or Changed Commands (cont.)

Command	Status	Chapter / Section	Description
access-list extended (named)	Modified	IPv4 Access Control List (ACL) Commands	This command has been modified. This command configures an extended named access-list that permits or denies packets from specific source and destination IP addresses. You can either create an extended named ACL together with an ACL filter entry in the Global Configuration mode, or you can use the IPv4 Extended ACL Configuration mode for sequenced ACL filter entry.
access-list (extended numbered)	Modified	IPv4 Access Control List (ACL) Commands	This command has been modified. This command configures an extended numbered access-list that permits or denies packets from specific source and destination IP addresses. You can either create an extended numbered ACL together with an ACL filter entry in the Global Configuration mode, or you can use the IPv4 Extended ACL Configuration mode for sequenced ACL filter entry.
access-list standard (named)	Modified	IPv4 Access Control List (ACL) Commands	This command has been modified. This command configures a standard named access-list that permits or denies packets from a specific source IP address. You can either create a standard named ACL together with an ACL filter entry in the Global Configuration mode, or you can use the IPv4 Standard ACL Configuration mode for sequenced ACL filter entry.
access-list (standard numbered)	Modified	IPv4 Access Control List (ACL) Commands	This command has been modified. This command configures a standard numbered access-list that permits or denies packets from a specific source IP address. You can either create a standard numbered ACL together with an ACL filter entry in the Global Configuration mode, or you can use the IPv4 Standard ACL Configuration mode for sequenced ACL filter entry.
ipv6 access-list extended (named)	Modified	IPv6 Access Control List (ACL) Commands	Use this command when configuring an IPv6 extended access-list for filtering frames that permit or deny IP, ICMP, TCP, UDP packets or ICMP packets with a specific value based on the source or destination. The no variant of this command removes a specified IPv6 extended access-list.
ipv6 access-list (named)	Modified	IPv6 Access Control List (ACL) Commands	Use this command to either create a new IPv6 hardware access-list, or to select an existing IPv6 hardware access-list in order to apply a filter entry to it. Use the no variant of this command to delete an existing IPv6 hardware access-list.

Table B-2: New or Changed Commands (cont.)

Command	Status	Chapter / Section	Description
ipv6 access-list named ICMP filter	Modified	IPv6 Access Control List (ACL) Commands	Use this ACL filter to add a filter entry for an IPv6 source and destination address and prefix, for ICMP (Internet Control Message Protocol) packets, to the current named IPv6 access-list. If a sequence number is specified, the new entry is inserted at the specified location. Otherwise, the new entry is added at the end of the access-list.
ipv6 access-list named IPv6 protocol filter	Modified	IPv6 Access Control List (ACL) Commands	Use this ACL filter to add a filter entry for an IPv6 source and destination address and prefix, with an IP protocol type specified, to the current named IPv6 access-list. If a sequence number is specified, the new entry is inserted at the specified location. Otherwise, the new entry is added at the end of the access-list.
ipv6 access-list named TCP UDP filter	Modified	IPv6 Access Control List (ACL) Commands	Use this ACL filter to add a filter entry for an IPv6 source and destination address and prefix, with TCP (Transmission Control Protocol) or UDP (User Datagram Protocol) source and destination ports specified, to the current named IPv6 access-list. If a sequence number is specified, the new entry is inserted at the specified location. Otherwise, the new entry is added at the end of the access-list.
ipv6 access-list standard (named)	Modified	IPv6 Access Control List (ACL) Commands	This command configures an IPv6 standard access-list for filtering frames that permit or deny IPv6 packets from a specific source IPv6 address. The no variant of this command removes a specified IPv6 standard access-list.
auth guest-vlan	Modified	Authentication Commands	This command enables and configures the Guest VLAN feature on the interface specified by associating a Guest VLAN with an interface. The new optional routing parameter enables routing from the Guest VLAN to another VLAN, so the switch can lease DHCP addresses and accept access to a limited network.
show radius local-server statistics	Modified	Local RADIUS Server Commands	Use this command to display statistics about the local RADIUS server. Note the 'Unknown username' and 'Invalid passwords' fields in the output have been replaced by a 'Failed Logins' field.
snmp-server enable trap	Modified	SNMP Commands	This command can now enable the switch to send DHCP snooping notifications (traps).
show stack	Modified	Stacking Commands	This command now shows provisioning details.
stack fallback-config (Disabled)	Modified	Stacking Commands	This command has been disabled. To simplify stack recovery, stub reconfiguration is now achieved by using a trigger that is generated by the type stack disabled-master command on page 87.23 .

Table B-2: New or Changed Commands (cont.)

Command	Status	Chapter / Section	Description
<code>switch bay provision</code>	Deprecated	Switching Commands	This command enables you to pre configure a specific empty bay within a switch ready for inserting a particular XEM type. To run this command, the bay position must be vacant and the selected XEM type must be one that is currently supported.

Table B-3: New or Changed SNMP MIBs

Feature	Status	Chapter / Section	Description
AT-DHCPSN-MIB	New	SNMP MIBs	This MIB contains objects for displaying and managing DHCP snooping and ARP security information on the switch.
Private MIBs	New	SNMP MIBs	Support for the sFlow Agent MIB has been added.

Appendix C: GUI Reference

Introduction.....	C.2
Installing and Setting-up the GUI	C.3
System Requirements.....	C.3
Installing the GUI to your switch using an SD card	C.3
Installing the GUI to Your Switch Via TFTP server	C.5
Using the GUI.....	C.7
System > Status	C.8
System > Status > System Details.....	C.9
System > Status > System Date and Time.....	C.10
System > Status > Top Ten Utilised Ports.....	C.10
System > Identity	C.11
System > Environment Monitoring	C.12
System > File Management	C.13
System > File Management > Copy File	C.14
System > File Management > Move File.....	C.15
System > Stacking	C.16
System > Stacking > Configure Stacking.....	C.17
System > Stacking > Configure Stack Member.....	C.18
System > License Management	C.19
System > License Management > Add Feature License.....	C.20
Switching > Ports	C.21
Switching > Ports > Monitor Port.....	C.24
Switching > Ports > Configure Port	C.25
Switching > VLANs	C.26
Switching > VLANs > Add VLAN.....	C.29
Switching > Link Aggregation	C.30
Switching > Link Aggregation > Add Static Channel.....	C.32
Switching > Link Aggregation > Add Dynamic Channel	C.32
Switching > FDB Table.....	C.32
IP > IP Interfaces	C.34
IP > IP Interfaces > Configure Primary IP Address	C.36
IP > IP Interfaces > Add Secondary IP Address	C.36
IP > Static Routes	C.37
IP > Static Routes > Add Static Route.....	C.38
IP > ARP	C.39
IP > DNS	C.40
IP > DNS > Add DNS Server	C.41
IP > IGMP Snooping	C.42
IP > IGMP Snooping > Configure Interface	C.43
Resiliency and High Availability > STP	C.44
Resiliency and High Availability > EPSR	C.46
Management > Device Utilities	C.48
Management > NTP	C.49
Management > NTP > Add NTP Association.....	C.50
Management > Remote CLI Access	C.51
Management > Logs	C.54
Management > Logs > Export Logs.....	C.55

Introduction

This appendix describes how to install, configure and use the Graphical User Interface (GUI) on switches running the AlliedWare Plus™ OS. The GUI provides extensive monitoring and essential configuration functionality for Allied Telesis switches via a web browser. This document explains how to install the GUI using either an SD card or via a TFTP server.

The GUI functionality is provided via a Java applet file. Before you can use the GUI to manage your switches, you must download the Java applet file, and install it to your switch's flash file system.

Once the Java applet file is present in your switch's flash, no specific commands are required to enable the GUI, or to inform the switch which Java applet file to use. Instead, when an incoming browser connection is established with the switch, the switch will automatically send the most recent compatible Java applet file that is present in its flash file system.

Different versions of the Java applet file will be compatible with different versions of the AlliedWare Plus™ OS. The AlliedWare Plus™ OS automatically determines if a Java applet file is compatible, so the Java applet file that is delivered to your browser will always be compatible with the AlliedWare Plus™ OS version running on the switch to which you have connected.

Note which products and software version the GUI works with, along with PC and browser specifications listed. You may need to install and run the latest Java Runtime Environment that you can download from the Sun site so your browser can fully support the GUI Java applet.

Installing and Setting-up the GUI

This section shows you how to install and setup the AlliedWare Plus™ GUI:

System Requirements

To install and run the AlliedWare Plus™ GUI you will require the following system products and setup:

- PC Platform:
Windows XP SP2 and up / Windows Vista SP1 and up
- Browser: (must support Java Runtime Environment (JRE) version 6)
Microsoft Internet Explorer 7.0 and up / Mozilla Firefox 2.0 and up

Installing the GUI to your switch using an SD card

Step 1: Download a GUI Java applet

The GUI Java applet file is available in a compressed (.zip) file with the AlliedWare Plus™ Operating System software from the Support area of the Allied Telesis Website: <http://www.alliedtelesis.com>. Download the Java applet file. This file will have .zip file name extension. You need to extract the Java .jar file from the compressed .zip file. The version number of the software applet file (.jar) gives the earliest version of the software file (.rel) that the GUI can operate with.

Step 2: Copy the GUI Java applet .jar file to an SD card.

Insert the SD card in the SD slot on the front of your switch. Connect to the management port, then login to the switch.

Copy the GUI Java applet to your switch, using the below commands:

```
awplus# copy card:<filename.jar> flash:/
```

Where **<filename.jar>** is the GUI Java applet file you downloaded in step 1.

Step 3: Assigning IP addresses

Use the following commands to assign the IP addresses for connecting to the Java applet.

```
awplus# configure terminal
awplus(config)# interface vlan1
awplus(config-if)# ip address <address>/<prefix-length>
```

Where **<address>** is the IP address that you will subsequently browse to when you connect to the GUI Java applet. For example, to give the switch an IP address of 192.168.2.6, with a subnet mask of 255.255.255.0, use the following command:

```
awplus(config-if)# ip address 192.168.2.6/24
```

Step 4: Configuring the Gateway

Configure your switch with a default gateway, if necessary, using these commands:

```
awplus(config-if)# exit  
  
awplus(config)# ip route 0.0.0.0/0 <gateway-address>
```

Where *<gateway-address>* is the IP address for your gateway device. Note that you do not need to define a default gateway if you browse to the switch from within its own subnet.

Step 5: Creating a user account

In order to log into the GUI, you must first create a user account. Use the following commands to setup a user account

```
awplus(config)# username <username> privilege 15 guiuser  
password <password>
```

Note that you can create multiple users to log into the GUI. See the AlliedWare Plus™ Software Reference for information about the `username` command.

Step 6: Logging into the GUI

Start a browser then enter the IP address you configured in step 3 as the URL. You will then be presented with a login screen after the GUI Java applet has started. You can then Log in with the username and password that you defined previously in the earlier step, named [Creating a user account](#).



Installing the GUI to Your Switch Via TFTP server

Step 1: Download a GUI Java applet file from the support site:

The GUI Java applet file is available in a compressed (zip) file with the AlliedWare Plus™ Operating System software from the Support area of the Allied Telesis Website: <http://www.alliedtelesis.com>. Download the Java applet file. This file will have .zip file name extension. You need to extract the Java .jar file from the compressed .zip file. The version number of the software applet file (.jar) gives the earliest version of the software file (.rel) that the GUI can operate with.

Step 2: Copy the GUI applet

Copy the GUI applet .jar file onto a TFTP server. Ensure this TFTP server is enabled and ready for the switch. Connect to the management port of the switch, then login to the switch. Do not connect to the management port of the TFTP server

Step 3: Assign the IP addresses:

Use the following commands to configure your switch with an appropriate IP address:

```
awplus# configure terminal
awplus(config)# interface vlan1
awplus(config-if)# ip address <address>/<prefix-length>
```

Where **<address>** is the IP address that you will subsequently browse to when you connect to the GUI Java applet. For example, to give the switch an IP address of 192.168.2.6, and a subnet mask of 255.255.255.0, use the following command:

```
awplus(config-if)# ip address 192.168.2.6/24
```

Use the following commands to configure your switch with a default gateway:

```
awplus(config-if)# exit
awplus(config)# ip route 0.0.0.0/0 <gateway-address>
```

Step 4: Configure the Default Gateway

In necessary, use the following commands to configure the default gateway.

```
awplus(config-if)# exit
awplus(config)# ip route 0.0.0.0/0 <gateway address>
```

Where **<gateway-address>** is the IP address for your gateway device. Note that you do not need to define a default gateway if you browse to the switch from within its own subnet.

Step 5: Copy the GUI Java applet to your switch

Use the following commands to copy the GUI Java applet to your switch:

```
awplus# copy tftp://<server-address>/
<filename.jar> flash:/
```

Where *<server-address>* is the IP address for the TFTP server, and where *<filename.jar>* is the GUI Java applet file you downloaded in step 1.

Step 6: Create a user account

In order to log into the GUI, you must first create a user account. Use the following commands to setup a user account

```
awplus(config)# username <username> privilege 15 guiuser  
password <password>
```

Note that you can create multiple users to log into the GUI. See the AlliedWare Plus™ Software Reference for information about the `username` command.

Step 7: Logging into the GUI

Start a browser then enter the IP address you configured in step 3 as the URL. You will then be presented with a login screen after the GUI Java applet has started. You can then Log in with the username and password that you defined previously in step 6.

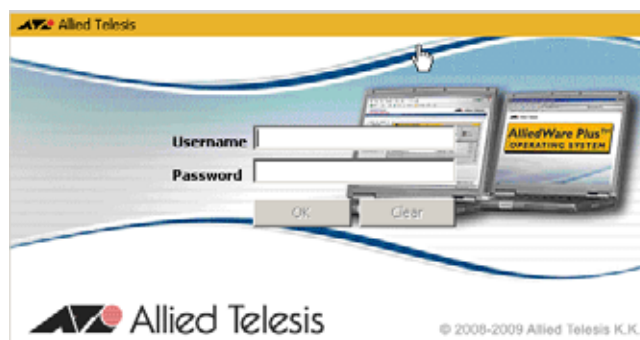

Using the GUI

This section explains how to use the AlliedWare Plus™ GUI. It assumes that you have installed the GUI on your switches and have the setup the browser on your PC. This procedure is covered in [“Installing and Setting-up the GUI” on page C.3](#).

In this section each screen is presented by its tab name and explains the content of the screen components.

System > Status

The **System > Status** menu tab enables you to display and configure basic system information.

The **CPU Used %** and **Memory Free %** graphs provide a brief history of CPU and memory usage.

Note For systems equipped and configured using VCStack, there is a separate tab for each stack member with the system name displayed on each tab.

Menu Tab Figure C-1: Example showing the **System > Status** menu tab:

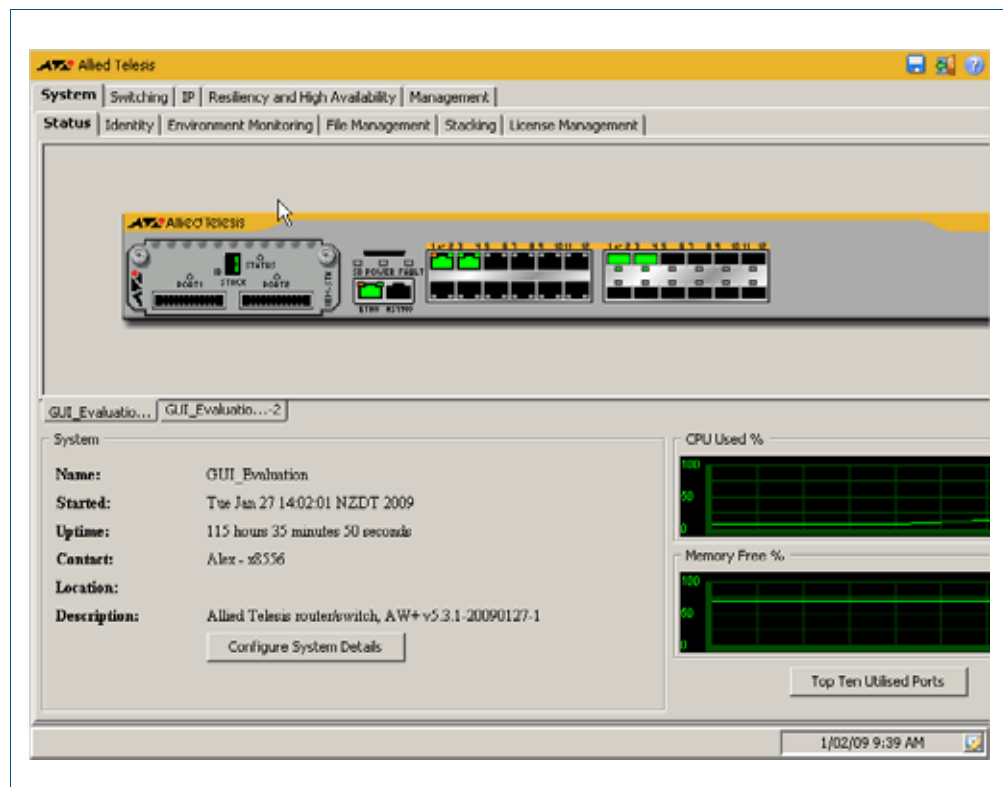

Description

Display Label / Field	Description
System / Name	Specifies the network name of the system, as set with the 'hostname' command in the CLI.
System / Started	Date and time the switch was last booted.
System / Uptime	Elapsed time since the last boot.
System / Contact	Contact details for system maintenance.
System / Location	Location of the switch

Display Label / Field	Description (cont.)
System / Description	Description of the switch, including manufacturer, model, and software version.
Top Ten Utilised Ports	Displays a sorted list of the ten most used ports listed by port and its utilization. You can rearrange and resort the list by port or utilization.

Description

Configuration Button / Field	Description
Configure System Details	Add or modify System Name, System Contact, System Location.
Configure System Details / System Name	Configures the network name of the system.
Configure System Details / System Contact	Configures the contact information for the system, from 0 to 255 characters long. Valid characters are any printable characters and spaces.
Configure System Details / System Location	Configures the location of the system, from 0 to 255 characters long. Valid characters are any printable characters and spaces.

System > Status > System Details

The System > Status > System Details dialog allows you to configure basic system information.

Configuration Dialog

Figure C-2: Example showing System > Status > Configure System Details dialog:

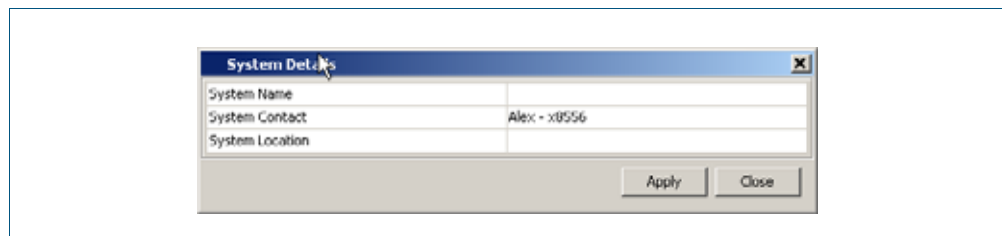

Description

Label / Field / Button	Description
System Name	Enter the network name of the system.
System Contact	Enter the contact information for the system, from 0 to 255 characters long. Valid characters are any printable characters and spaces.
System Location	Enter the location of the system, from 0 to 255 characters long. Valid characters are any printable characters and spaces.

System > Status > System Date and Time

The System > Status > System Date and Time dialog allows you to configure the date and time for the switch.

Configuration Dialog

Figure C-3: Example showing System > Status > System Date and Time dialog:

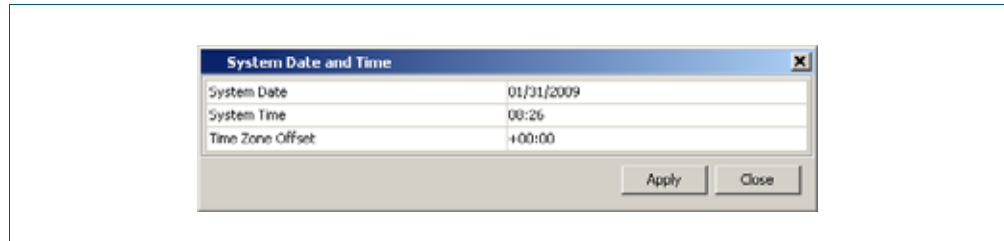

Description

Label / Field / Button	Description
System Name	Enter the network name of the system.
System Contact	Enter the contact information for the system, from 0 to 255 characters long. Valid characters are any printable characters and spaces.
System Location	Enter the location of the system, from 0 to 255 characters long. Valid characters are any printable characters and spaces.

System > Status > Top Ten Utilised Ports

The System > Status > Top Ten Utilised Port dialog allows you to monitor port utilisation on the switch.

Configuration Dialog

Figure C-4: Example showing System > Status > Top Ten Utilised Ports dialog:

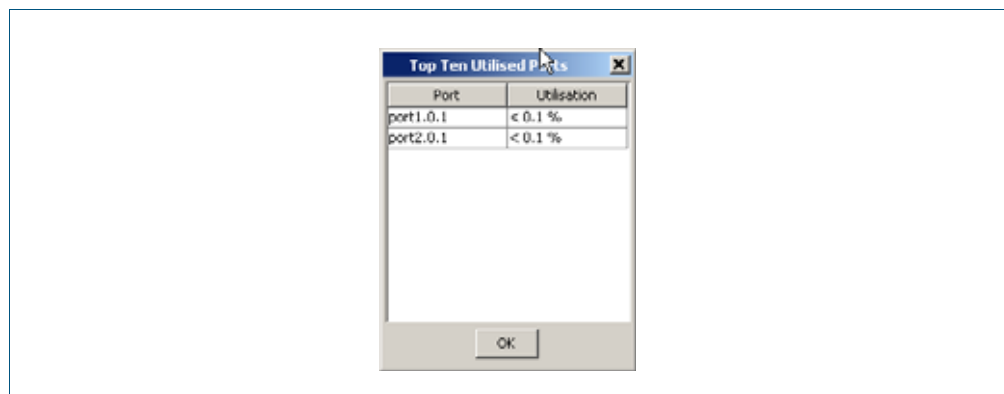

Description

Label / Field / Button	Description
Port	Displays up to ten ports that are used the most on the switch. You can sort by ascending or descending port order.
Utilisation	Displays the utilisation percentage for the port. You can sort by ascending or descending utilisation percentage.

System > Identity

The **System > Identity** menu tab displays physical properties, software version and configuration file name.

Note For systems equipped and configured using VCStack there is a separate tab for each stack member with the system name displayed on each tab.

Menu Tab Figure C-5: Example showing the **System > Identity** menu tab:

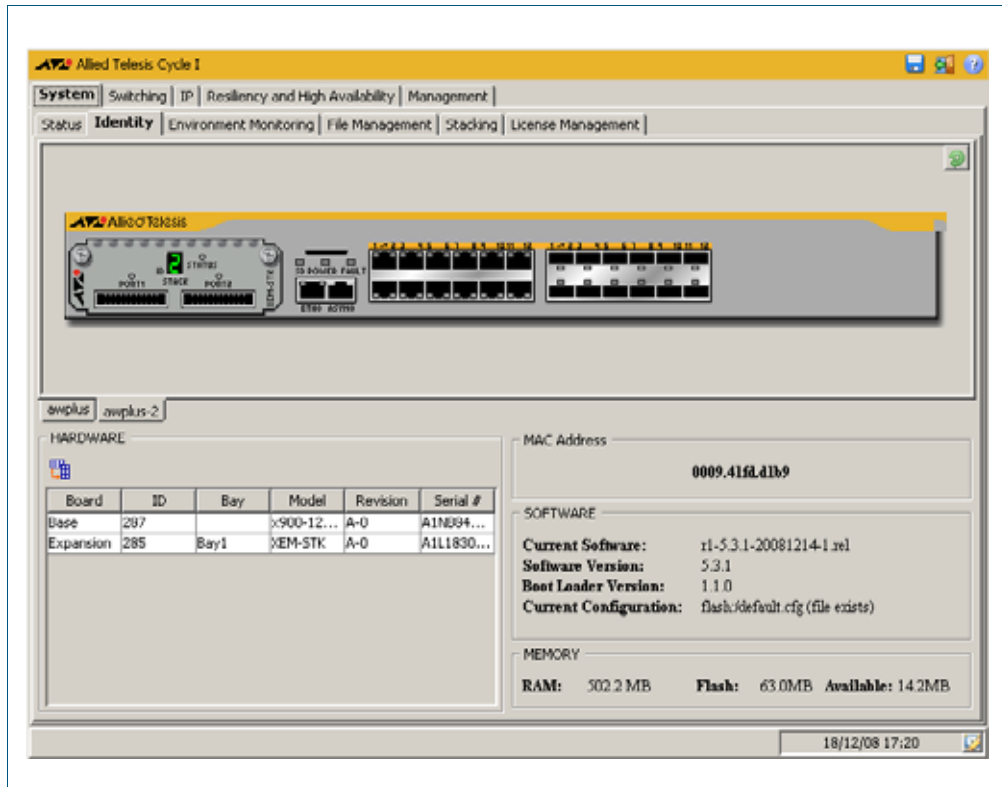

Description

Label / Field / Button	Description
HARDWARE	Displays the board, bay, model, revision and serial number of the switch main board and any installed XEMs.
MAC Address	Displays the MAC Address of the switch in hexadecimal in the format HHHH.HHHH.HHHH.
SOFTWARE	Displays the software release file name, software version, boot loader version, and configuration file name loaded on the switch.
MEMORY	Displays the amount of installed RAM and flash, plus the remaining Flash available on the switch.

System > Environment Monitoring

The **System > Environment Monitoring** menu tab allows you to display the status of the environmental properties, such as all voltages and temperatures, which the system monitors.

Note For systems equipped and configured using VCStack there is a separate tab for each stack member with the system name displayed on each tab.

Menu Tab Figure C-6: Example showing the **System > Environment Monitoring** menu tab:

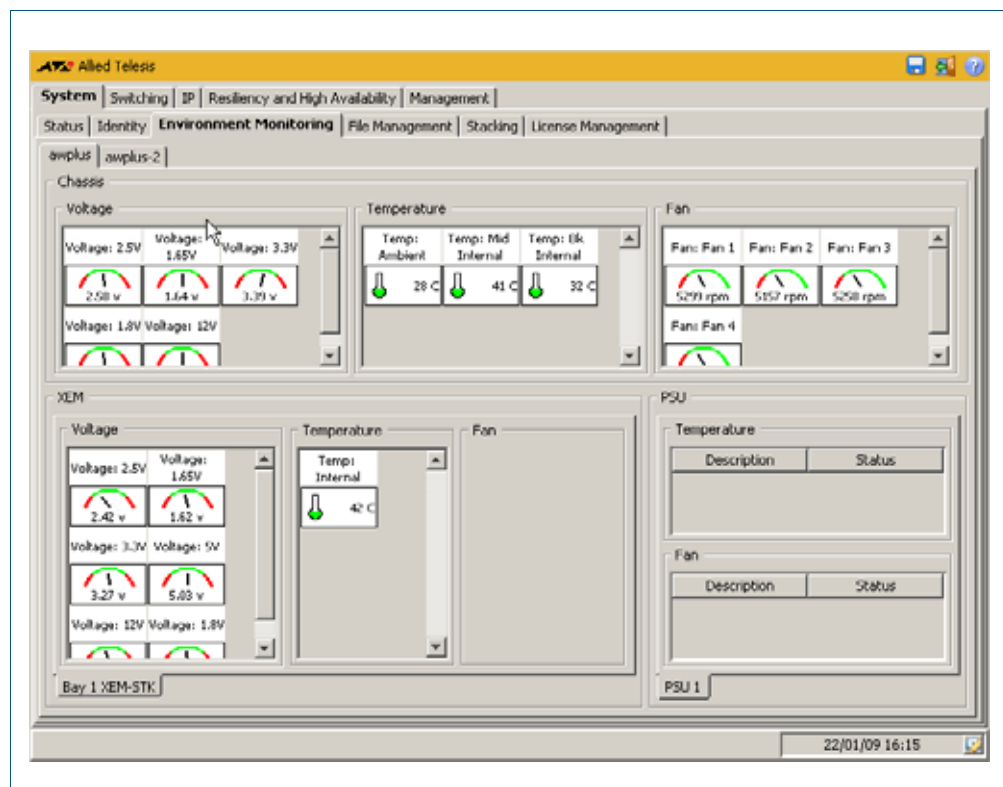

Description

Label / Field / Button	Description
Chassis	Displays the operational status of chassis voltages and temperatures for the switch.
Fan	Displays the operational status of the switch fans.
XEM	Displays the operational status of voltages, temperatures, and fans for any installed XEMs.
PSU	Displays the operational status of temperatures and fans for any installed pluggable PSUs.

System > File Management

The System > File Management menu tab allows you to create, copy, delete, upload or download files to and from the switch.

Menu Tab Figure C-7: Example showing the System > File Management menu tab:

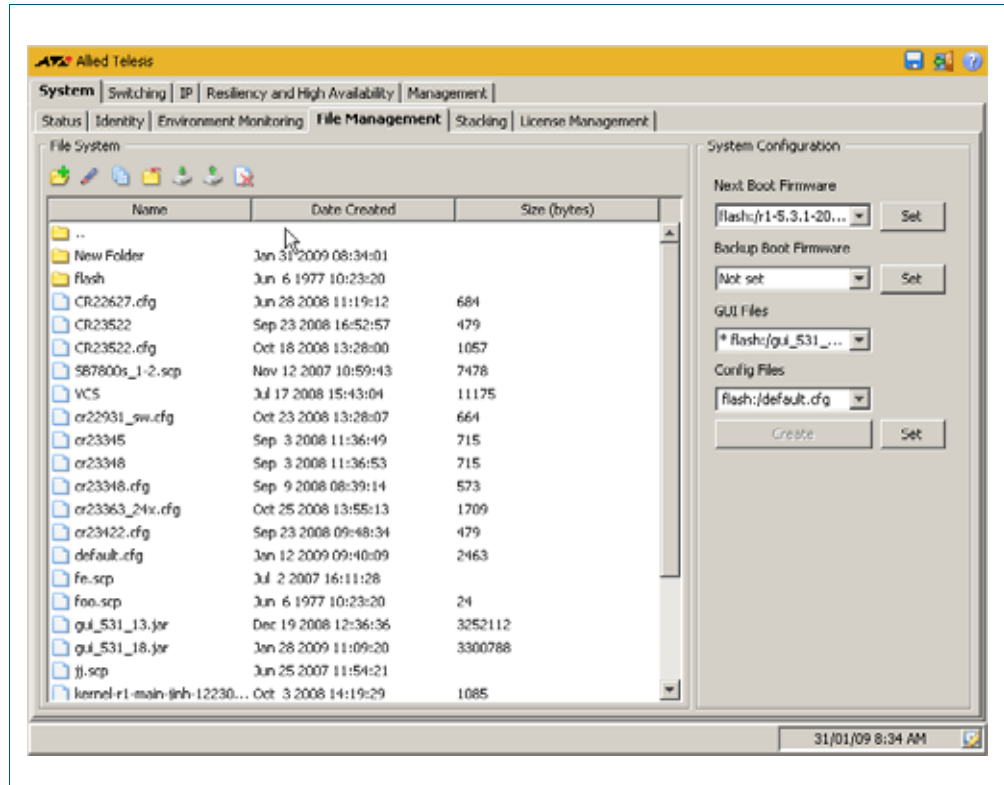

Description:
File System

Label / Field / Button	Description
File System	Displays file names, file dates, and file sizes of files in Flash, NVS or SD-card.
File System / Add Folder	Select the folder you want to create a new sub-folder in then click on the Add Folder icon located directly below the File System label.
File System / Rename File or Folder	Select the file or folder you want to rename then click on the Rename File or Folder icon located directly below the File System label.
File System / Copy File or Folder	Select the file or folder you want to rename then click on the Copy File or Folder icon located directly below the File System label. Choose the Destination Folder from the drop down list in the Copy File dialog then select OK to copy the file or folder to the chosen destination.
File System / Move File or Folder	Select the file or folder you want to move then click on the Move File or Folder icon located directly below the File System label. Choose the Destination Folder from the drop down list in the Move File dialog then select OK to move the file or folder to the chosen destination.

Label / Field / Button	Description (cont.)
File System / Download File	Select the file you want to download then click on the Download File icon located directly below the File System label.
File System / Upload File	Select the file you want to upload then click on the Upload File icon located directly below the File System label.

Description:
System Configuration

Label / Field / Button	Description
System Configuration	Configures running and backup software, GUI software, and configuration files in Flash or card memory available on the switch.
System Configuration / Next Boot Firmware	Choose the Next Boot Firmware .rel file and path from the drop down list then click Set to make this file the firmware that starts after reboot.
System Configuration / Backup Boot Firmware	Choose the Backup Boot Firmware .rel file and path from the drop down list then click Set to make this file the fallback boot firmware at reboot.
System Configuration / GUI Files	Choose the GUI Files .jar file and path from the drop down list then click Set to make this file the GUI file that you connect to after reboot.
System Configuration / Config Files	Choose the Config Files .cfg file and path from the drop down list then click Set to make this file the config file that the switch uses at reboot.

System > File Management > Copy File

The **System > File Management > Copy File** dialog allows you to copy release and configuration files.

Configuration Dialog

Figure C-8: Example showing **System > File Management > Copy File** dialog:

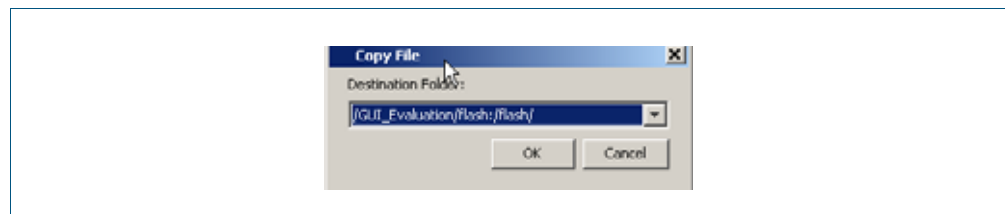

Description

Label / Field / Button	Description
Destination Folder	Enter the destination folder to copy the selected file to.

System > File Management > Move File

The System > File Management > Move File dialog allows you to move release and configuration files.

Configuration Dialog

Figure C-9: Example showing System > File Management > Move File dialog:

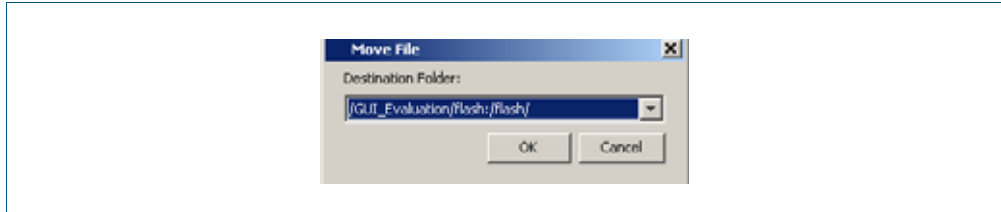

Description

Label / Field / Button	Description
Destination Folder	Enter the destination folder to move the selected file to.

System > Stacking

The **System > Stacking** menu tab allows you to display and monitor a summary of the identity and status of stack members, plus you can also configure the VLAN ID and IP subnets used for internal VCStack communication.

Menu Tab Figure C-10: Example showing the **System > Stacking** menu tab:

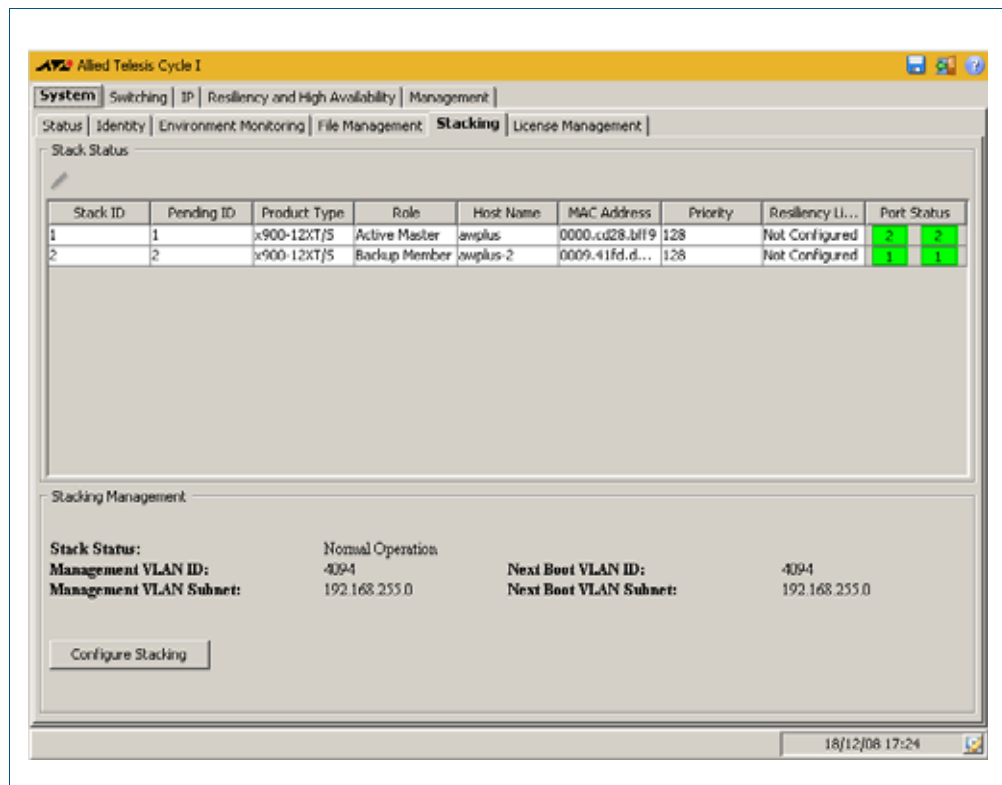

Description: Stack Status

Label / Field / Button	Description
Stacking Management / Stack Status	The stack's overall status. Note that a warning is issued if the stack is not connected in a standard ring topology.
Stacking Management / Management VLAN ID	The VLAN ID currently used for stack management. The default stack management VLAN ID is 4094.
Stacking Management / Next Boot VLAN ID	The VCS management VLAN ID to be assigned after the next reboot.
Stacking Management / Next Boot VLAN Subnet	The stacking management VLAN subnet address after rebooting.
Configure Stacking	Configures the VCS management VLAN ID and the subnet address of the VCS management VLAN.

Description:
Stacking
Management

Label / Field / Button	Description
Stack Status / Stack ID	The Stack member ID.
Stack Status / Pending ID	The Stack member ID to be assigned to the device after the next reboot.
Stack Status / Product Type	The Stack member product type; for example, SwitchBlade x908.
Stack Status / Role	Stack member's role in the stack (either master or backup).
Stack Status / Host Name	The host name of the Stack member.
Stack Status / MAC Address	Stack member's hardware MAC address. Note that frames from devices within a stacked virtual chassis will carry the source address of the stack master.
Stack Status / Priority	The priority for election of stack master (0 to 255). The lowest number has the highest priority. Note that where stack members have the same priority setting, the switch with the lowest MAC address will become the stack master.
Stat Status / Port Status	The status of the stack port, can be: "Down", "Neighbour incompatible", "Discovering neighbour", or "Learnt neighbour <neighbour member ID>".

System > Stacking > Configure Stacking

The **System > Stacking > Configure Stacking** dialog allows you to configure the VLAN ID and IP subnets used for internal VCStack communication.

Configuration
Dialog

Figure C-11: Example showing **System > Stacking > Configure Stacking** dialog:

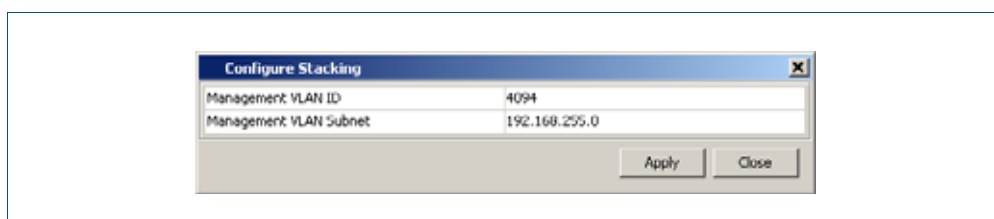
Description

Label / Field / Button	Description
Management VLAN ID	Enter the VLAN ID for stack management. The default stack management VLAN ID is 4094.
Management VLAN subnet	Enter the subnet address of the VCS management VLAN.

System > Stacking > Configure Stack Member

The **System > Stacking > Configure Stack Member** dialog allows you to configure the Pending ID, Priority, Software Version Auto Synchronization and Operational Status used for internal VCStack communication.

Configuration Dialog

Figure C-12: Example showing **System > Stacking > Configure Stack Member** dialog:

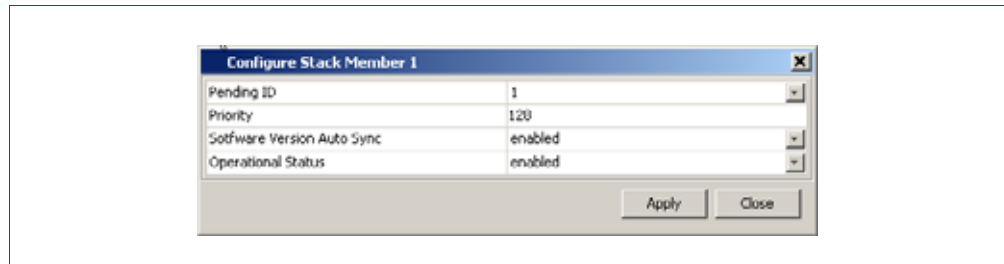

Description

Label / Field / Button	Description
Pending ID	Enter the Pending ID for the stack member.
Priority	Enter the Priority for the stack member.
Software Version Auto Sync	Select the enabled or disabled options to enable or disable the Software Version Auto Synchronization feature for the stack member.
Operational Status	Select the enabled or disabled options to enable or disable the stack member.

System > License Management

The System > License Management menu tab allows you to view, add and delete feature licenses.

Note For systems equipped and configured using VCStack there is a separate tab for each stack member with the system name displayed on each tab.

Note If a license is added to, or deleted from, a stack member then the same action must be taken on all other stack members. Otherwise incompatible licensing will occur and affected devices will not rejoin the stack following a reboot.

Menu Tab Figure C-13: Example showing the System > License Management menu tab:

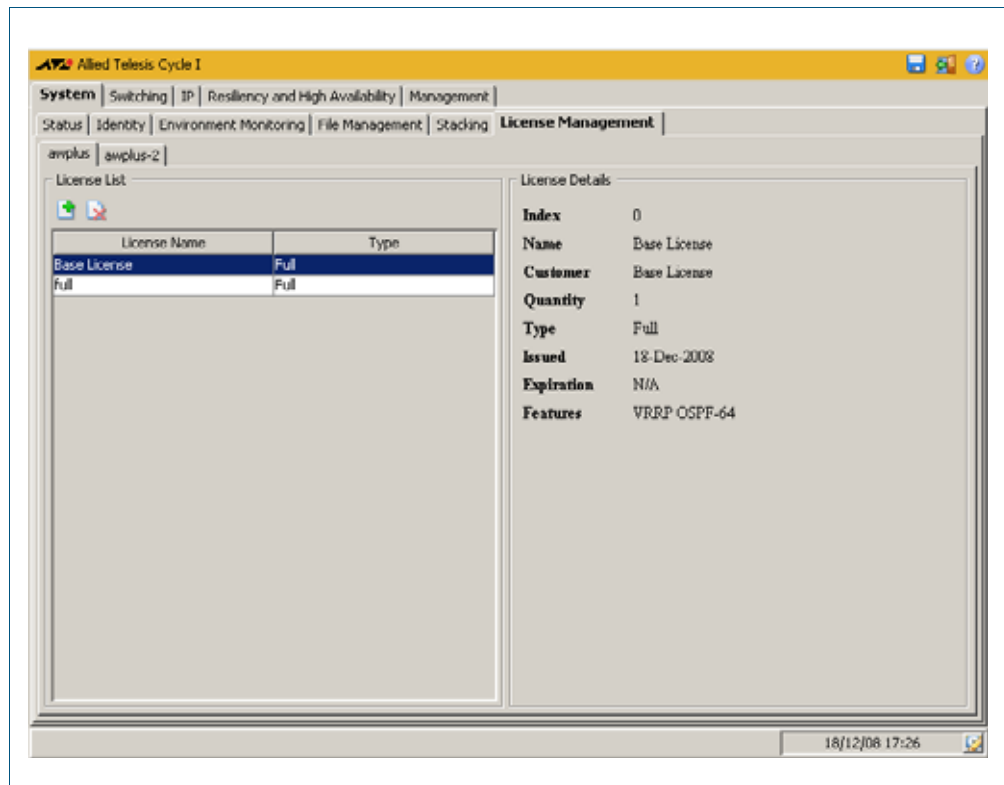

Description

Label / Field / Button	Description
License List / License Name	Name of the license bundle.
License List / Type	The type of license activated on the switch: full or temporary.
License Details / Index	Index identifying entry.
License Details / Name	Name of the license bundle.
License Details / Customer	Customer name.
License Details / Quantity	Quantity of licenses included in the feature key.
License Details / Type	Full or Temporary license types.
License Details / Issued	Date the key was generated.
License Details / Expiration	Expiry date for a Temporary license.
License Details / Features	List of features enabled by the license.

System > License Management > Add Feature License

The **System > License Management > Add Feature License** dialog allows you add feature licenses by specifying the license name and the license key.

Configuration Dialog Figure C-14: Example showing **System > License Management > Add Feature License** dialog:

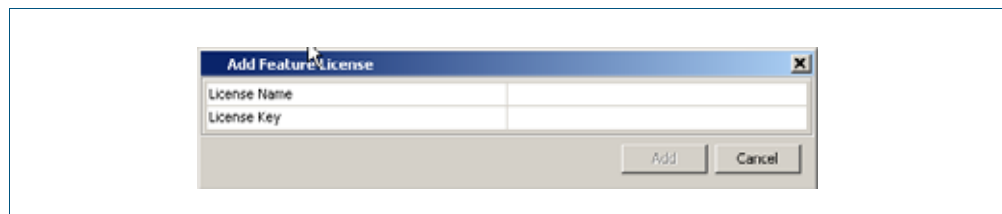

Description

Label / Field / Button	Description
License Name	Enter the license name of the software feature.
License Key	Enter the encrypted license key to enable this software feature.

Switching > Ports

The Example showing **System > License Management > Add Feature License** dialog: menu tab allows you to view, and configure Layer 1 properties:

- Right-clicking a port allows you to select monitoring or configuration dialogs for the selected port.
- The monitoring dialog displays port status, statistics and a brief utilization history.
- The configuration dialog allows you to configure Administrative State, Auto Negotiation, Speed and Duplex settings for the port.

Note Speed and Duplex settings can only be changed if Auto Negotiation is disabled.



Note For systems equipped and configured using VCStack there is a separate tab for each stack member with the system name displayed on each tab.



Menu Tab Figure C-15: Example showing the **Switching > Ports** menu tab:

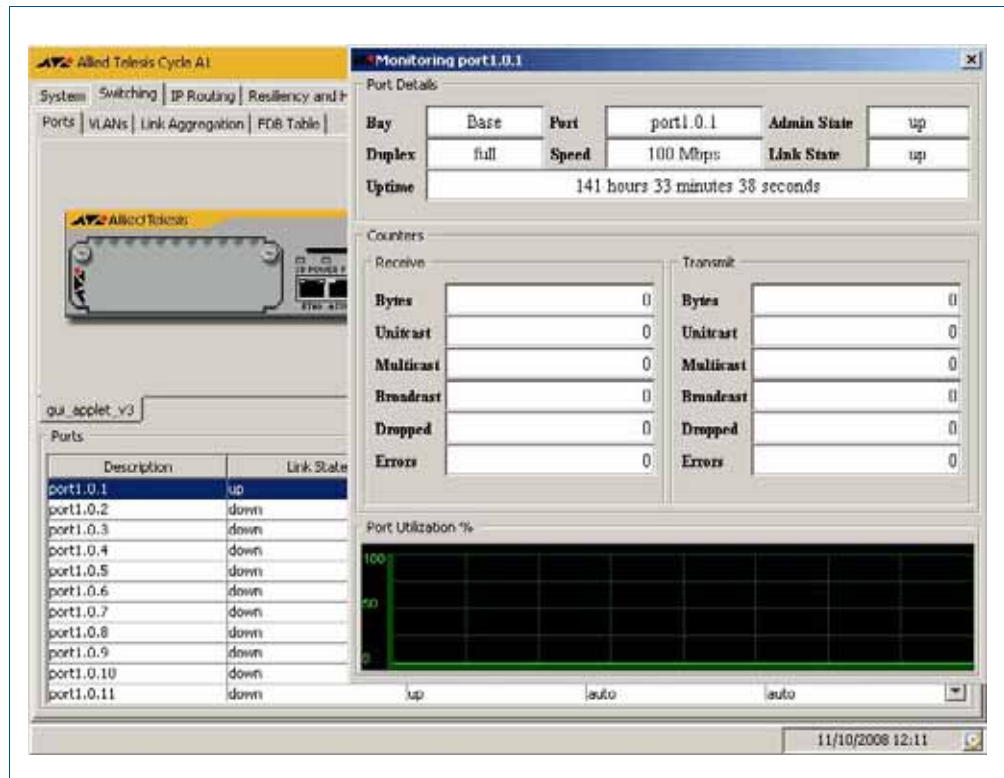

Description

Label / Field / Button	Description
Ports	Displays port number, link and administrative status, duplex mode, speed and uptime (in milliseconds) for the selected port.

Menu Tab Figure C-16: Example showing the **Switching > Ports > ALL** menu tab:

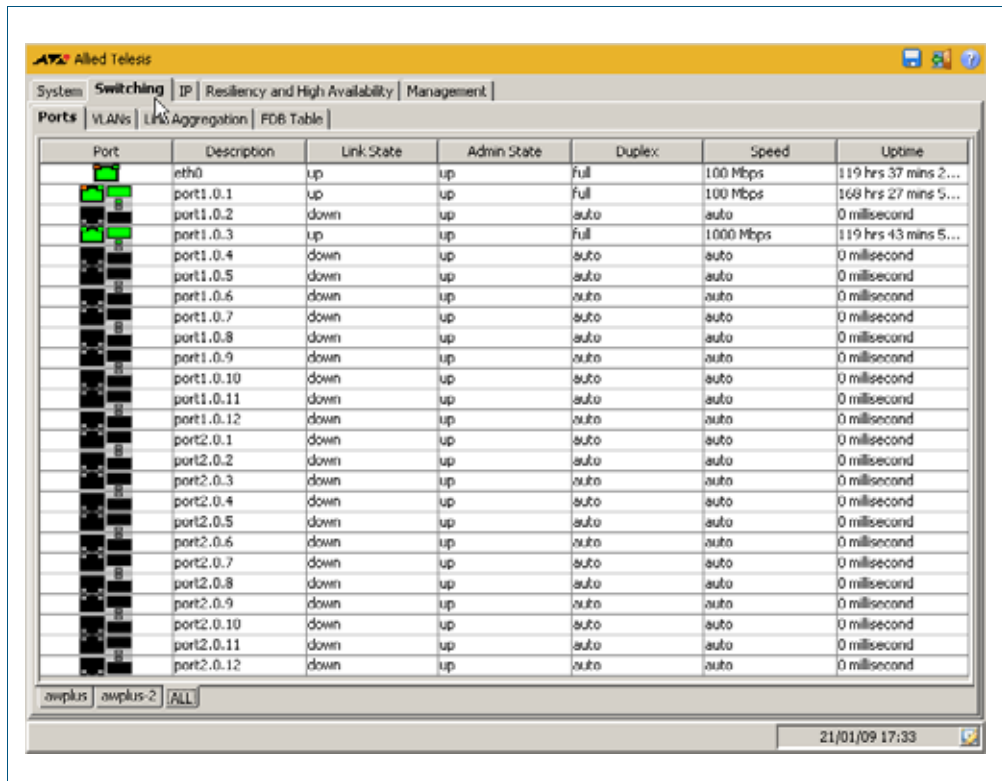

Legend Figure C-17: Example showing **Switching > Ports > Legend**:



Switching > Ports > Monitor Port

The Example showing **System > License Management > Add Feature License** dialog: dialog allows you monitor port counters.

Configuration Dialog

Figure C-18: Example showing the **Switching > Ports > Monitor Port** dialog:

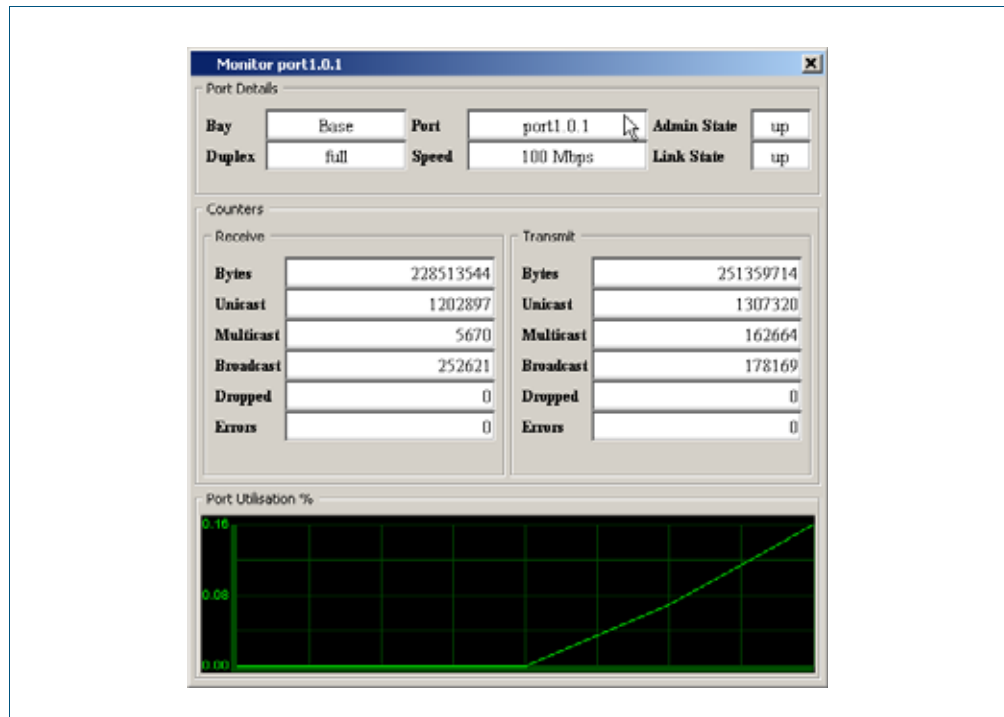

Description

Label / Field / Button	Description
Port Details	Monitors the bay, port, duplex, speed, administrative state and link states for the selected port.
Counters	Monitors the counters for bytes received/transmitted, unicast packets received/transmitted, multicast packets received/transmitted, broadcast packets received/transmitted, dropped packets received/transmitted, and errors received/transmitted for the selected port.
Port Utilisation%	Monitors and graphs the usage percentage for the selected port.

Switching > Ports > Configure Port

The Example showing **System > License Management > Add Feature License** dialog: dialog allows you configure Administrative State, Auto Negotiation, Speed and Duplex settings for the selected port.

Configuration Dialog

Figure C-19: Example showing the **Switching > Ports > Configure Port** dialog:

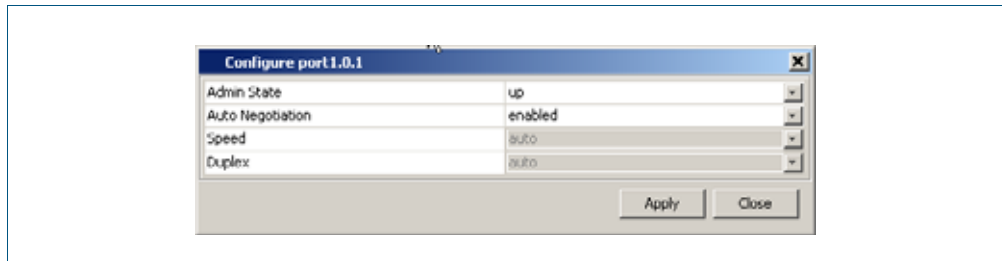

Description

Label / Field / Button	Description
Admin State	Select <code>up</code> or <code>down</code> from the drop down list in this dialog to specify the administrative state for the selected port.
Auto Negotiation	Select <code>disabled</code> or <code>enabled</code> from the drop down list in this dialog to specify auto negotiation for the selected port. Note that selecting <code>enabled</code> to enable Auto Negotiation will disable Speed and Duplex options, indicated by greyed out options.
Speed	Select <code>10 Mbps</code> , <code>100 Mbps</code> , <code>1000 Mbps</code> , <code>10 Gbps</code> , or <code>auto</code> from the drop down list in this dialog to specify the speed setting for the selected port. Note that the options for speed settings are only available if Auto Negotiation has been disabled for the selected port.
Duplex	Select <code>full</code> , <code>half</code> , or <code>auto</code> from the drop down list in this dialog to specify the duplex setting for the selected port. Note that the options for duplex settings are only available if Auto Negotiation has been disabled for the selected port.

Switching > VLANs

The Example showing **System > License Management > Add Feature License** dialog; menu tab allows you to view, and configure Layer 2 properties:

- Right-clicking a port allows you to select a VLAN to be tagged or untagged for the port, or to remove a port from the VLAN.
- Define VLANs before assigning VLANs to ports on the front panel of the switch.
- Selecting the **+** icon (under the VLAN Interface label on the VLAN tab below the front panel illustration) allows you to add a VLAN by specifying the VLAN ID and VLAN Name.
- Selecting the **x** icon (under the VLAN Interface label below the front panel illustration) allows you to delete a VLAN (except for the default VLAN 1 that is assigned to all ports).

Note For systems equipped and configured using VCStack there is a separate tab for each stack member with the system name displayed on each tab.



Menu Tab Figure C-20: Example showing the **Switching > VLANs** menu tab:

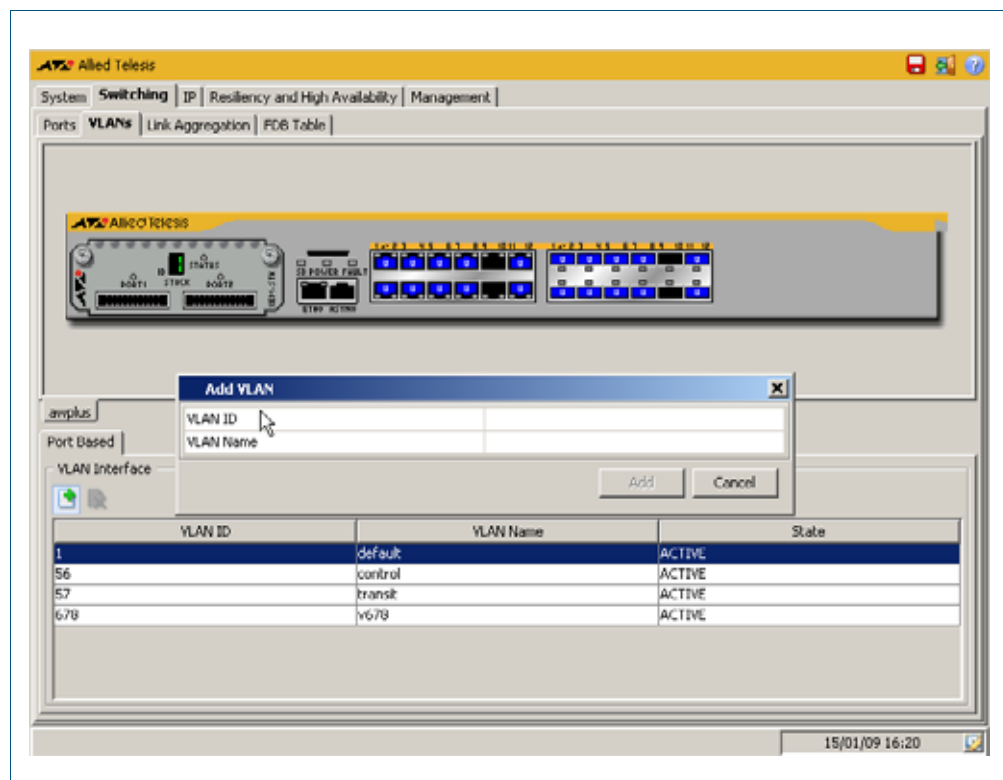

Description

Label / Field / Button	Description
Port Based / VLAN ID	The VID of the VLAN that is enabled or disabled in the range 1-4094.

Label / Field / Button	Description (cont.)
Port Based / VLAN Name	The ASCII name of the VLAN with a maximum length of 32 characters.
Port Based / State	The state of the VLAN, either enabled ('ACTIVE' displayed) or disabled ('INACTIVE' displayed).

Menu Tab Figure C-21: Example showing the **Switching > VLANs > ALL** menu tab:

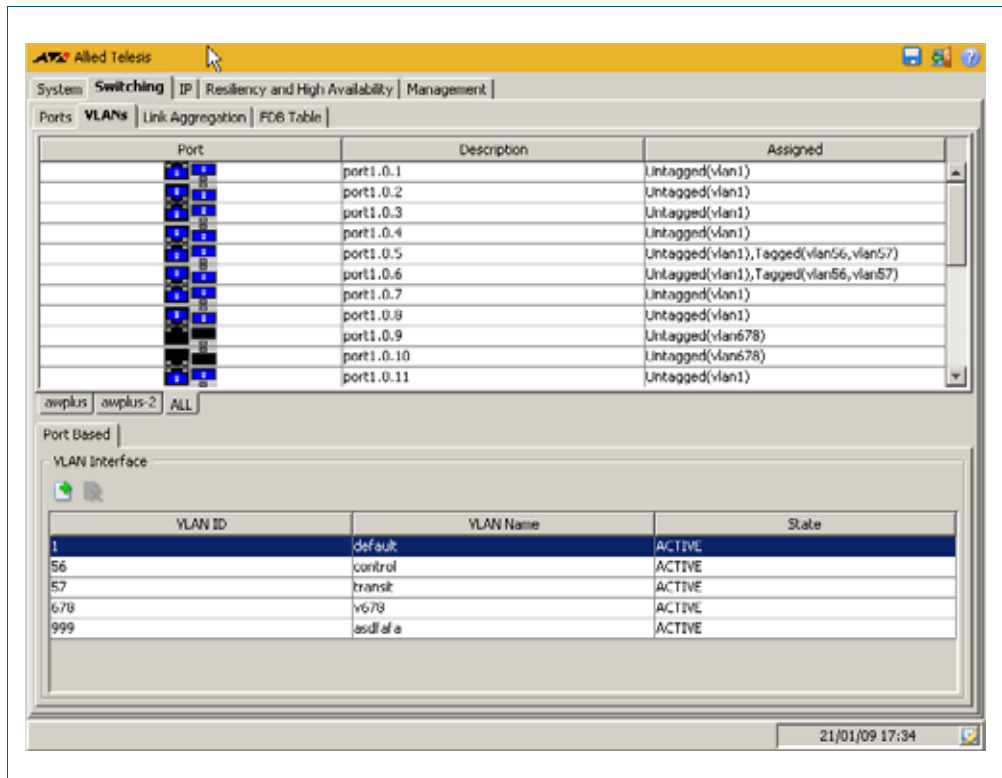

Legend Figure C-22: Example showing **Switching > VLANs > Legend**:

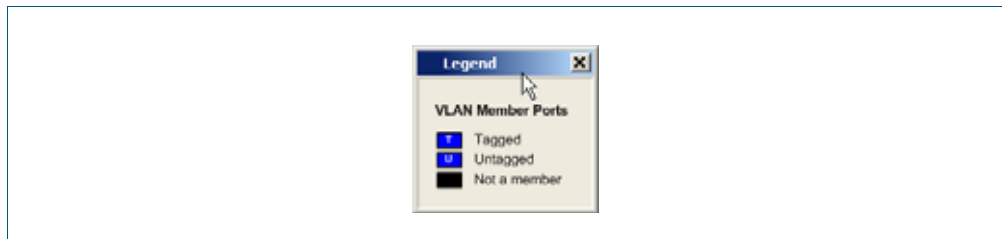

Switching > VLANs > Add VLAN

The Example showing **System > License Management > Add Feature License** dialog: dialog allows you add a VLAN by specifying the VLAN ID and VLAN Name.

Configuration Dialog Figure C-23: Example showing the **Switching > VLANs > Add VLAN** dialog:

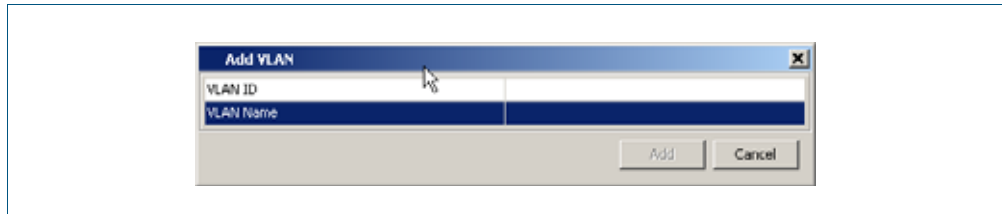

Description

Label / Field / Button	Description
VLAN ID	Enter the VID of the VLAN that is enabled or disabled in the range <1-4094>.
VLAN Name	Enter the ASCII name of the VLAN with a maximum length of 32 characters.

Switching > Link Aggregation

The **Switching > Link Aggregation** menu tab allows you to view, and configure layer 2 properties:

- Right-clicking a port allows you to select assign or remove the port to a Static Channel or a Dynamic Channel (LACP - Link Aggregation Control Protocol) group.
- Define Static Channel or Dynamic Channel (LACP) groups before assigning them to ports on the front panel of the switch.
- Selecting the + icon (located below the front panel illustration of your switch) allows you to add a Static Channel or Dynamic Channel (LACP) group by specifying the Channel ID.

Note Up to 31 Static Channel groups and up to 99 Dynamic Channel (LACP) groups can be defined on a switch.



- Selecting the x icon (located below the front panel illustration of your switch) allows you to delete a Static Channel or Dynamic Channel (LACP) group.

Note For systems equipped and configured using VCStack there is a separate tab for each stack member with the system name displayed on each tab.



Menu Tab Figure C-24: Example showing the **Switching > Link Aggregation** menu tab:

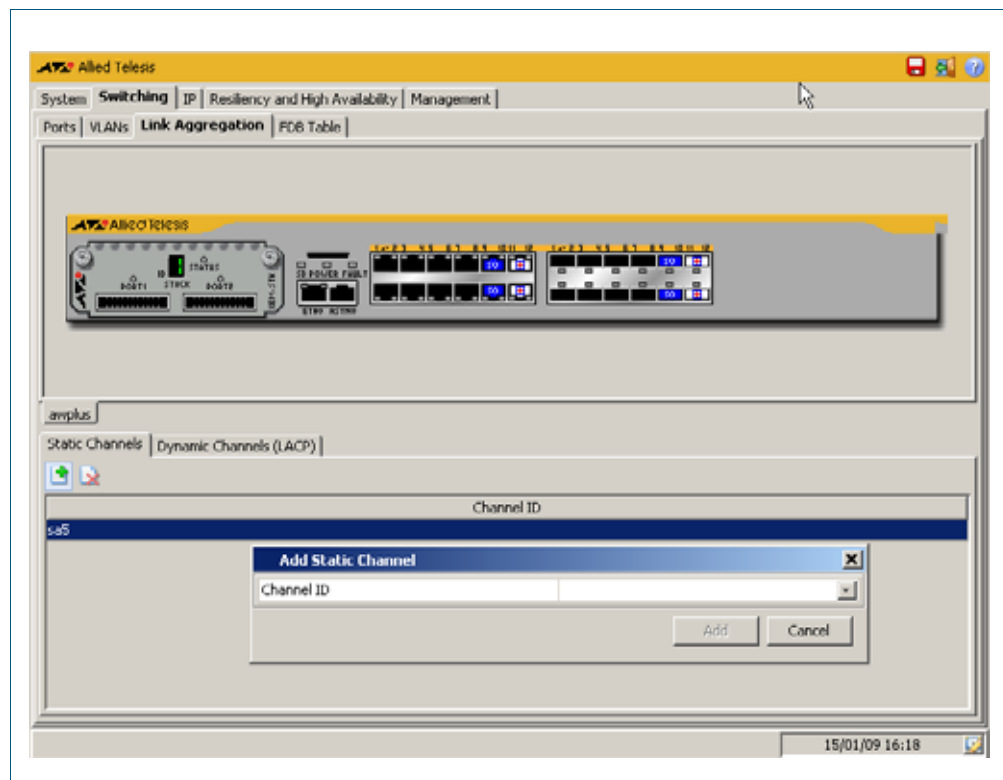

Description

Label / Field / Button	Description
Static Channels	Display or specify a static channel group number for an aggregated link. Up to 31 static channel groups can be created on the switch.
Dynamic Channels (LACP)	Display or specify a dynamic channel group number for an LACP link. Up to 99 dynamic channel groups can be created on the switch.

Menu Tab Figure C-25: Example showing the **Switching > Link Aggregation > ALL** menu tab:

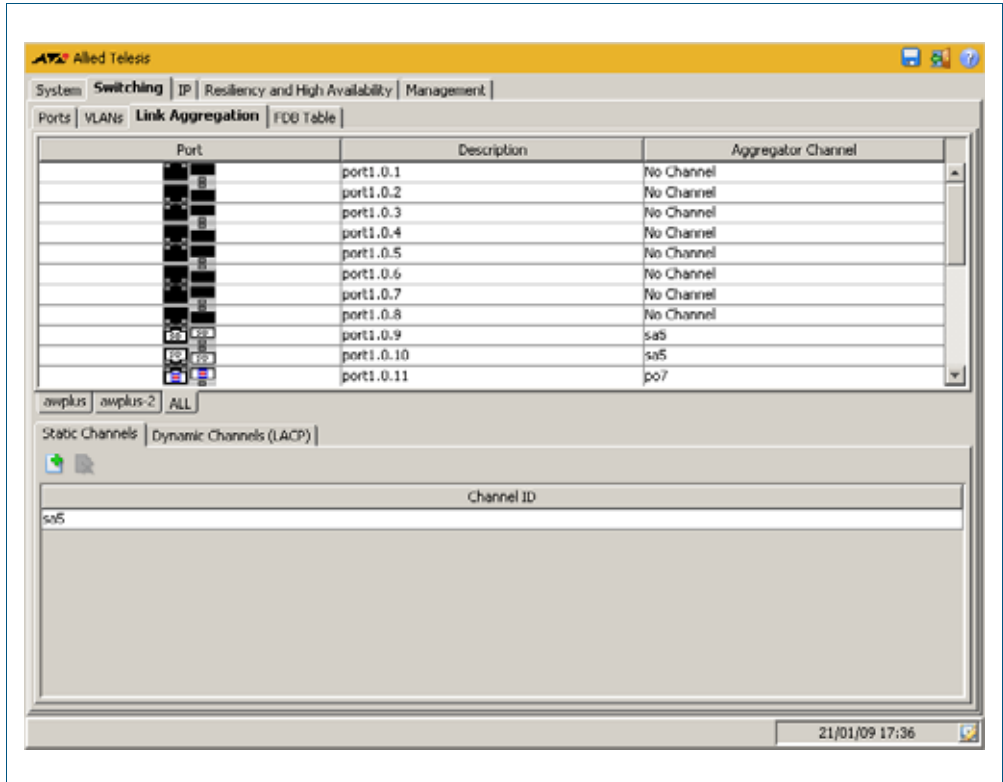

Legend Figure C-26: Example showing **Switching > Link Aggregation > Legend**:

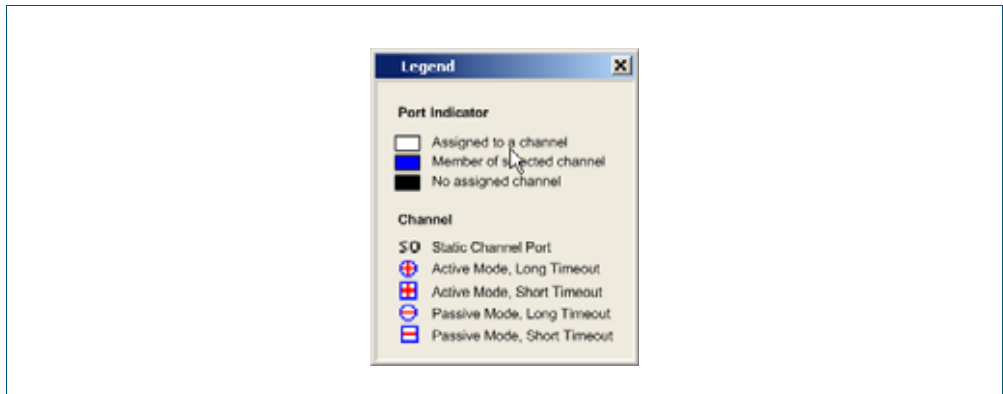

Switching > Link Aggregation > Add Static Channel

The **Switching > Link Aggregation > Add Static Channel** dialog allows you to assign the selected port to a Static Channel group.

Configuration Dialog Figure C-27: Example showing the **Switching > Link Aggregation > Add Static Channel** dialog:

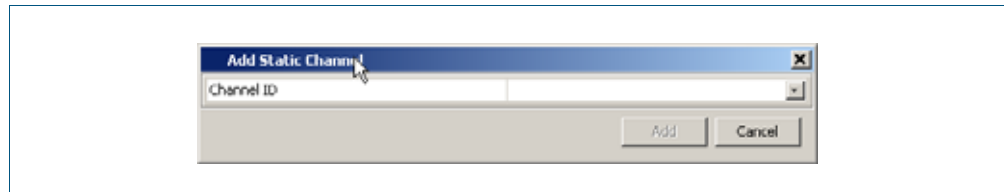

Description

Label / Field / Button	Description
Channel ID	Specify a static channel group number for an interface. Up to 31 static channel groups can be created on the switch.

Switching > Link Aggregation > Add Dynamic Channel

The **Switching > Link Aggregation > Add Dynamic Channel** dialog allows you to assign the selected port to a Dynamic Channel (LACP) group.

Configuration Dialog Figure C-28: Example showing **Switching > Link Aggregation > Add Dynamic Channel** dialog:



Description

Label / Field / Button	Description
Channel ID	Specify a dynamic (LACP) channel group number for an interface. Up to 99 dynamic (LACP) channel groups can be created on the switch.

Switching > FDB Table

The **Switching > FDB Table** menu tab allows you to view the contents of the Layer 2 Forwarding Database Table.

You can change the FDB Table view to display horizontally or vertically by selecting the table view icon above the FDB Table.

You can also sort or rearrange the display of the FDB Table by Port, MAC Address, or Forwarding Status by selecting the relevant column or by dragging the relevant column respectively.

Menu Tab Figure C-29: Example showing the **Switching > FDB Table** menu tab:

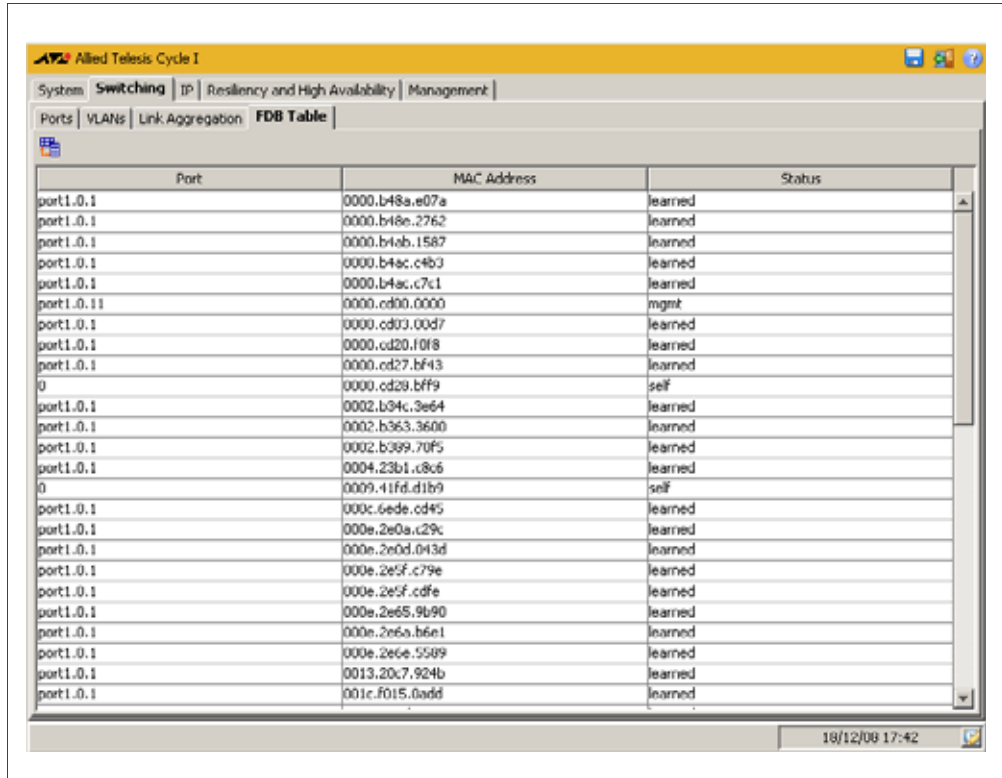

Port	MAC Address	Status
port1.0.1	0000.b48a.e07a	learned
port1.0.1	0000.b48e.2762	learned
port1.0.1	0000.b4ab.1587	learned
port1.0.1	0000.b4ac.c4b3	learned
port1.0.1	0000.b4ac.c7c1	learned
port1.0.11	0000.cd00.0000	mgmt
port1.0.1	0000.cd03.00d7	learned
port1.0.1	0000.cd20.f0f8	learned
port1.0.1	0000.cd27.bf43	learned
0	0000.cd29.bff9	self
port1.0.1	0002.b34c.3e64	learned
port1.0.1	0002.b363.3600	learned
port1.0.1	0002.b399.70f5	learned
port1.0.1	0004.23b1.c8c6	learned
0	0009.41fd.d1b9	self
port1.0.1	000c.6ede.cd45	learned
port1.0.1	000e.2e0a.c29c	learned
port1.0.1	000e.2e0d.043d	learned
port1.0.1	000e.2e5f.c79e	learned
port1.0.1	000e.2e5f.cdfc	learned
port1.0.1	000e.2e65.9b90	learned
port1.0.1	000e.2e6a.b6e1	learned
port1.0.1	000e.2e6e.5509	learned
port1.0.1	0013.20c7.924b	learned
port1.0.1	001c.f015.0add	learned

Description

Label / Field / Button	Description
FDB Table	Displays the FDB (Forwarding Database) table for the switch that shows all the available ports, MAC addresses, and port status.

IP > IP Interfaces

The **IP > IP Interfaces** menu tab allows you to view and specify the Primary and Secondary IP Addresses for VLAN and management port interfaces.

Note You may only define a Secondary IP Address for an interface after first defining its Primary IP Address.

- Select an interface then use the pen shaped icon under the Primary IP Address label to configure an IP address. You can delete an assigned Primary IP Address in the Configure Primary IP Address dialog as displayed after selecting the icon under Primary IP Address.
- Select an interface with a Primary IP Address already defined to configure a Secondary IP Address, using the + icon under the Secondary IP Address label.
- Remove a selected Secondary IP Address using the x icon under the Secondary IP Address Address label.

Menu Tab Figure C-30: Example showing the **IP > IP Interfaces** menu tab:

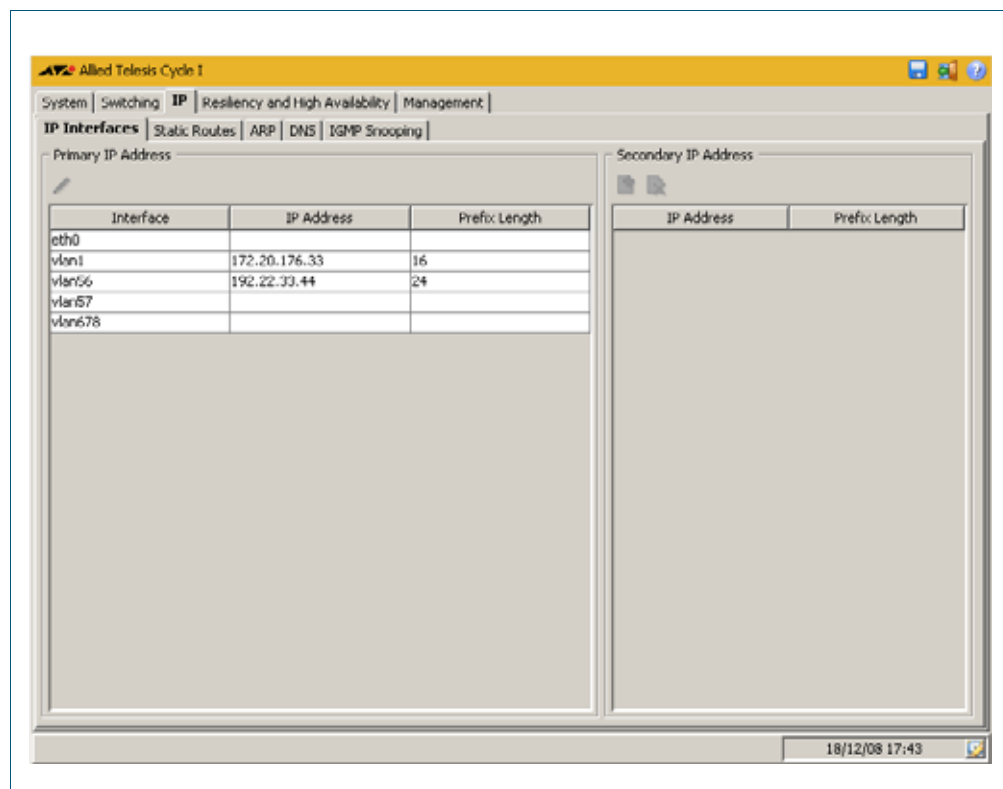

Description

Label / Field / Button	Description
Primary IP Address	Displays and configures primary IP addressing for VLANs and management port interfaces that are defined on the switch and assigned to ports.
Secondary IP Address	Displays and configures secondary IP addressing for VLANs and management port interfaces that are defined on the switch and assigned to ports.

IP > IP Interfaces > Configure Primary IP Address

The IP > IP Interfaces > Configure Primary IP Address dialog allows you to configure a primary address with an IP address and a prefix length for the selected interface.

Configuration Dialog Figure C-31: Example showing the IP > IP Interfaces > Configure Primary IP Address dialog:

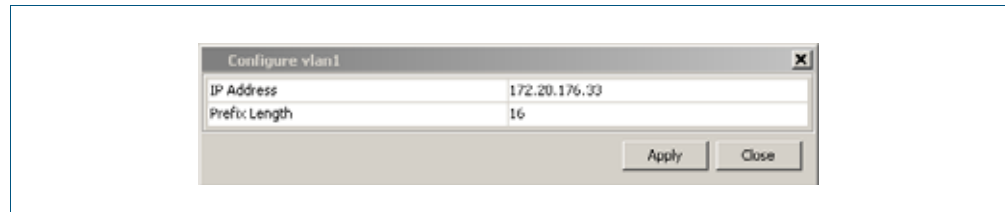

Description

Label / Field / Button	Description
IP Address	Enter or remove an IPv4 Address in dotted decimal notation (i.e. A.B.C.D).
Prefix Length	Enter the Prefix for the IPv4 Address with the integer as used for slash notation (i.e. 24 instead of /24), not dotted decimal notation (i.e. 255.255.255.0).

IP > IP Interfaces > Add Secondary IP Address

The Example showing the IP > IP Interfaces > Configure Primary IP Address dialog: dialog allows you to add a secondary address with an IP address and a prefix length for the selected interface (only if the selected interface already has a primary address configured).

Configuration Dialog Figure C-32: Example showing the IP > IP Interfaces > Add Secondary IP Address dialog:



Description

Label / Field / Button	Description
IP Address	Enter an IPv4 Address in dotted decimal notation (i.e. A.B.C.D).
Prefix Length	Enter the Prefix for the IPv4 Address with the integer as used for slash notation (i.e. 24 instead of /24), not dotted decimal notation (i.e. 255.255.255.0).

IP > Static Routes

The Example showing the **IP > IP Interfaces > Configure Primary IP Address** dialog: menu tab allows you to view, add, and delete static IP routes configured on the switch. Static routes are specified using destination IP addresses, masks, and gateways.

You can also sort or rearrange the display of the Static Routes by Destination, Gateway, or Mask by selecting the relevant column or by dragging the relevant column respectively.

- Selecting the + icon allows you to define a Static Route specifying destination and gateway IPv4 addresses with a dotted decimal format subnet mask.
- Selecting the x icon allows you to delete a defined Static Route.

Menu Tab Figure C-33: Example showing the **IP > Static Routes** menu tab:

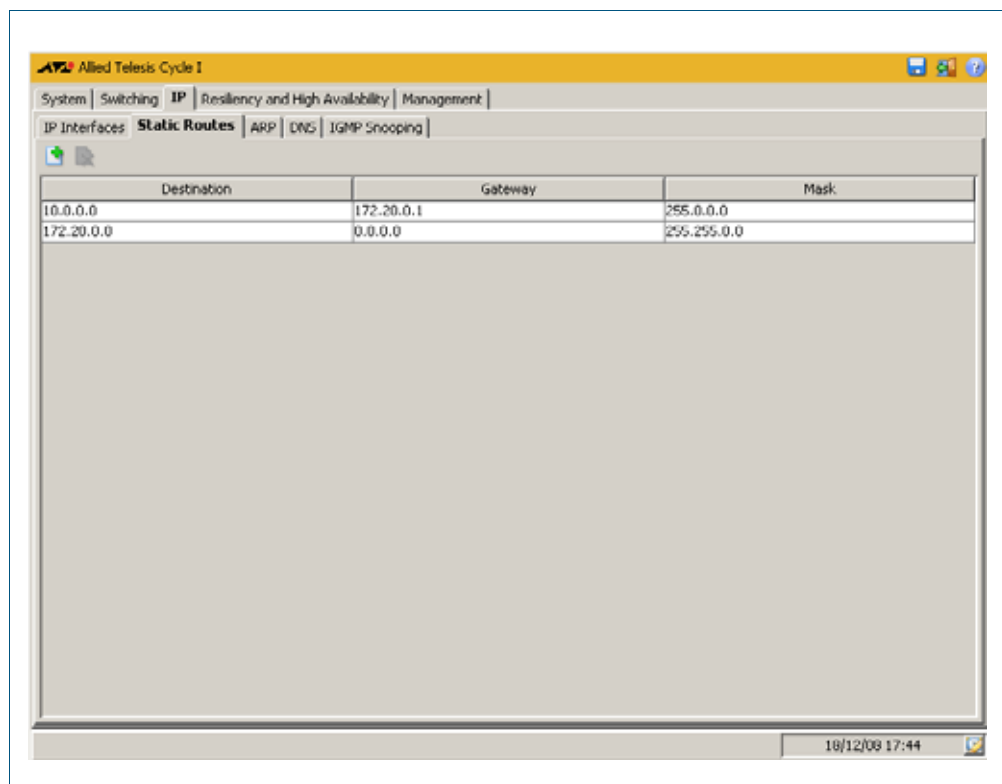

Description

Label / Field / Button	Description
Static Routes / Destination	The IPv4 address of the destination subnet address.
Static Routes / Gateway	The IPv4 address of the gateway device.
Static Routes / Mask	The subnet mask in dotted decimal notation (for example, 255.255.255.0 instead of the slash notation /24).

IP > Static Routes > Add Static Route

The IP > Static Routes > Add Static Route dialog allows you to add a static IP routes on the switch. Static routes are specified using destination IP addresses, masks, and gateways.

Configuration Dialog

Figure C-34: Example showing the IP > Static Routes > Add Static Route dialog:

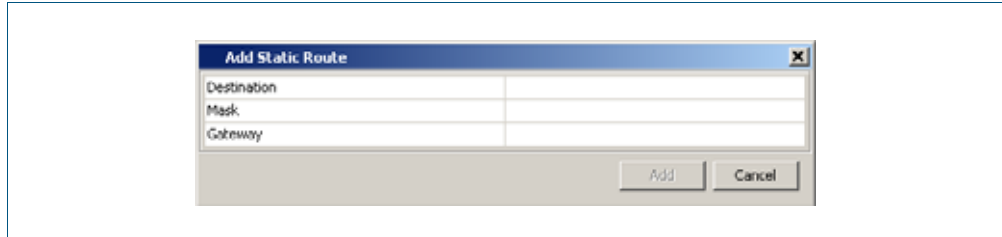

Description

Label / Field / Button	Description
Destination	Enter the IPv4 address of the destination subnet address.
Mask	Enter the subnet mask in dotted decimal notation (for example, 255.255.255.0 instead of the slash notation /24).
Gateway	Enter the IPv4 address of the gateway device.

IP > ARP

The **IP > ARP** menu tab allows you to view the contents of the ARP (Address Resolution Protocol) Table.

You can change the ARP Entries view to display horizontally or vertically by selecting the table view icon above the ARP Entries.

You can also sort or rearrange the display of the ARP Entries by Interface, IP Address, MAC Address, or Type by selecting the relevant column or by dragging the relevant column respectively.

Menu Tab Figure C-35: Example showing the **IP > ARP** menu tab:

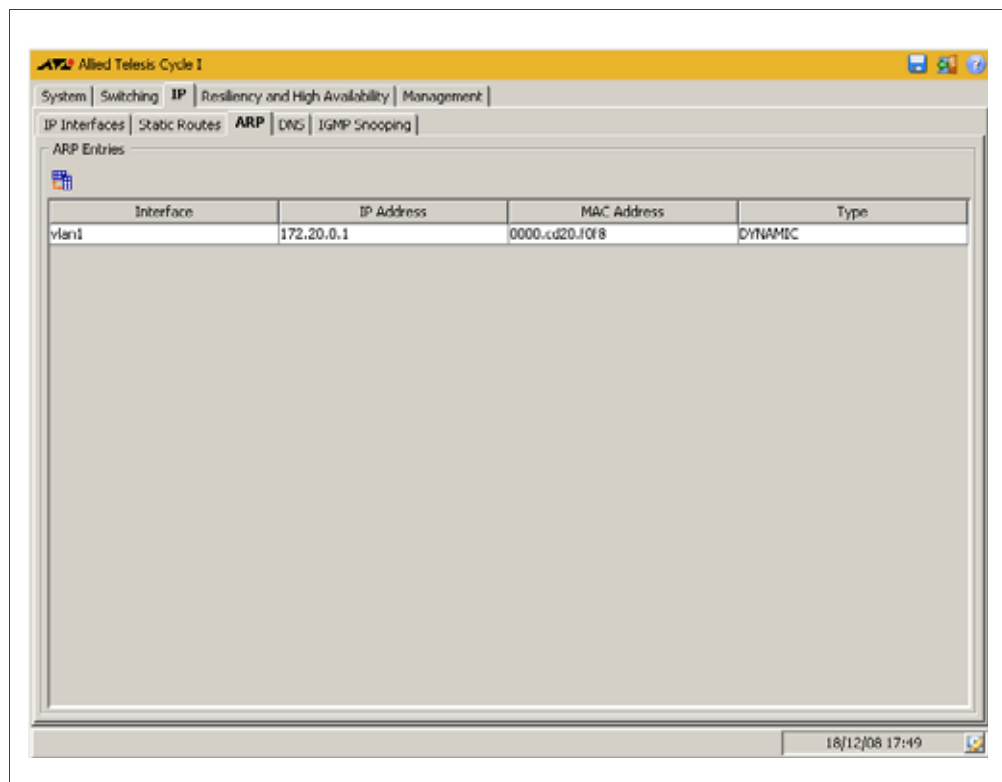

Description

Label / Field / Button	Description
ARP Entries / Interface	Interface over which the switch is accessed, usually a VLAN.
ARP Entries / IP Address	IP address of the network device this ARP entry maps to.
ARP Entries / MAC Address	Hardware address of the switch in hexadecimal format HHHH.HHHH.HHHH.
ARP Entries / Type	Indicates whether the ARP entry is a Static or Dynamic ARP entry. Static ARP entries are added and dynamic ARP entries are learned.

IP > DNS

The **IP > DNS** menu tab allows you to display and configure DNS (Domain Name System) server entries for the switch.

- Selecting the + icon allows you to define a DNS Server specifying the IPv4 address.
- Selecting the x icon allows you to delete a defined DNS Server.

Figure C-36: Example showing the **IP > DNS** menu tab:

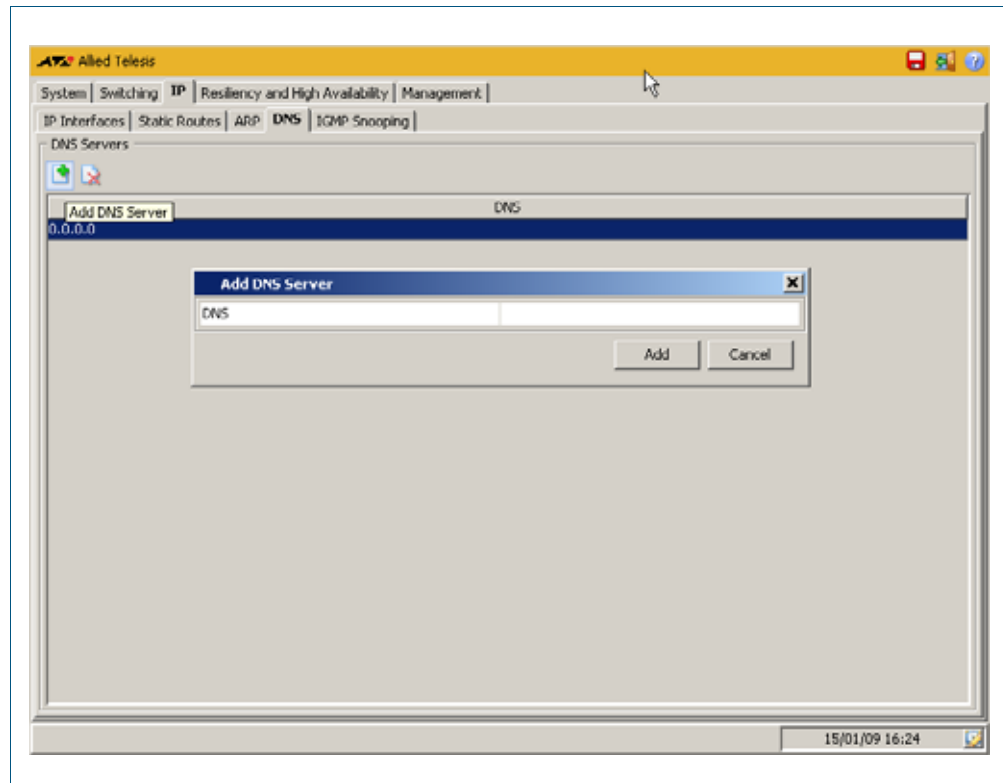

Description

Label / Field / Button	Description
DNS	DNS Server IPv4 address.

IP > DNS > Add DNS Server

The IP > DNS > Add DNS Server dialog allows you to add DNS (Domain Name System) server entries for the switch.

Configuration Dialog Figure C-37: Example showing the **IP > DNS > Add DNS Server** dialog:

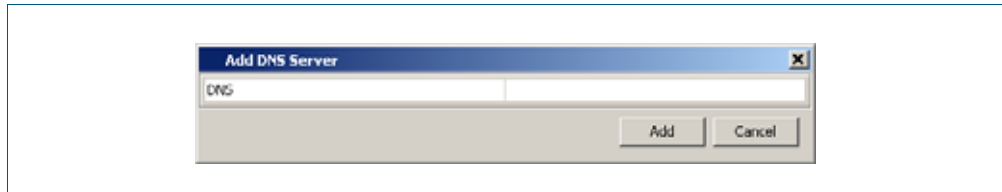

Description

Label / Field / Button	Description
DNS	Enter an IPv4 address in dotted decimal notation (i.e. A.B.C.D) for the DNS (Domain Name System) Server you want to specify.

IP > IGMP Snooping

Menu Tab The **IP > IGMP Snooping** menu tab displays basic IGMP Snooping and Multicast Routing Interface information.

You can also configure IGMP Snooping on individual ports by selecting the VLAN interface that the port is a member of then clicking on the pen shaped icon to display the Configure IGMP Snooping dialog, where you can enable or disable IGMP snooping on desired ports.

Menu Tab Figure C-38: Example showing the **IP > IGMP Snooping** menu tab:

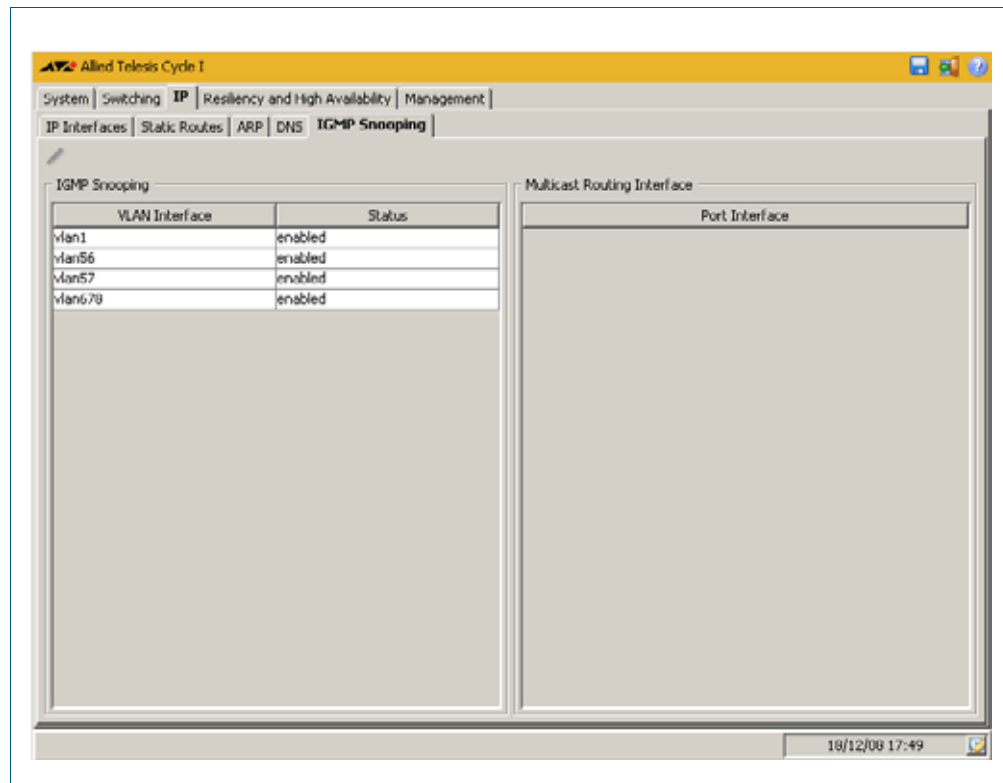

Description

Label / Field / Button	Description
IGMP Snooping / IGMP Snooping	Displays and configures IGMP Snooping for a specified VLAN interface.
IGMP Snooping / Multicast Routing Interface	Displays and configures the specified port in the VLAN as a multicast router for IGMP Snooping.

IP > IGMP Snooping > Configure Interface

The IP > IGMP Snooping > Configure Interface dialog allows you to configure IGMP Snooping on individual ports. First select the VLAN interface that the port is a member of then enable or disable IGMP snooping on desired ports from this dialog.

Configuration Dialog

Figure C-39: Example showing the IP > IGMP Snooping > Configure Interface dialog:

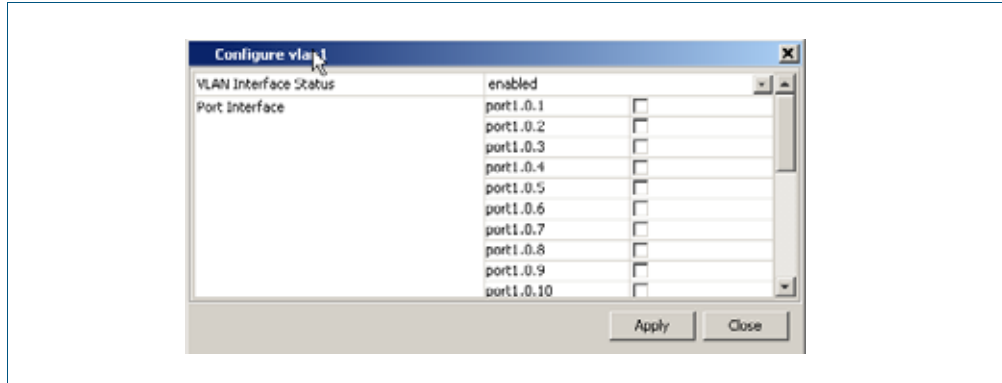

Description

Label / Field / Button	Description
VLAN Interface Status	Displays whether the selected VLAN is enabled or disabled.
Port Interface	Select the check box for a given port to allocate it to the VLAN.

Resiliency and High Availability > STP

The **Resiliency and High Availability > STP** menu tab allows you to view the configuration and status of spanning tree data: for the switch as a whole and for each port.

You can also sort or rearrange the display of the Port State table by Port, Port Priority, Port State, STP Enabled, Port Path Cost, or Designated Bridge ID by selecting the relevant column or by dragging the relevant column respectively.

Note  STP is not configurable through the GUI. Refer to the relevant STP chapters in the AlliedWare Plus™ Software Reference to configure STP using the CLI instead.

Menu Tab Figure C-40: Example showing the **Resiliency and High Availability > STP** menu tab:

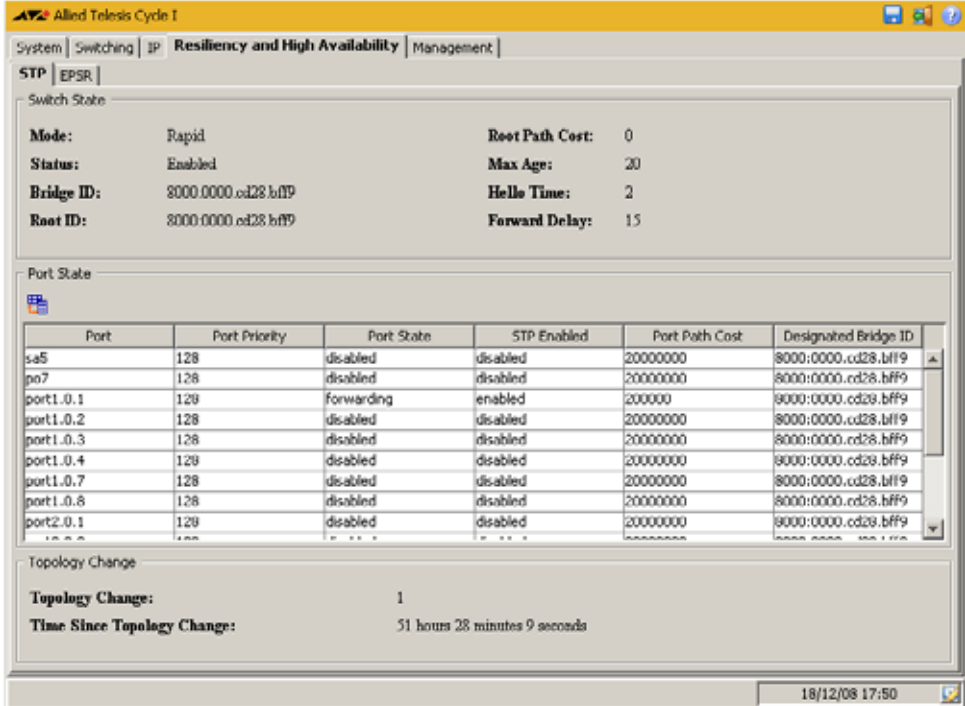

The screenshot shows the 'Resiliency and High Availability > STP' menu tab in the Allied Telesis GUI. The page is divided into several sections:

- Switch State:**
 - Mode: Rapid
 - Status: Enabled
 - Bridge ID: 8000.0000.cd28.bff9
 - Root ID: 8000.0000.cd28.bff9
 - Root Path Cost: 0
 - Max Age: 20
 - Hello Time: 2
 - Forward Delay: 15
- Port State:** A table with the following columns: Port, Port Priority, Port State, STP Enabled, Port Path Cost, and Designated Bridge ID.

Port	Port Priority	Port State	STP Enabled	Port Path Cost	Designated Bridge ID
sa5	128	disabled	disabled	20000000	8000:0000.cd28.bff9
po7	128	disabled	disabled	20000000	8000:0000.cd28.bff9
port1.0.1	128	forwarding	enabled	2000000	9000:0000.cd28.bff9
port1.0.2	128	disabled	disabled	20000000	8000:0000.cd28.bff9
port1.0.3	128	disabled	disabled	20000000	8000:0000.cd28.bff9
port1.0.4	128	disabled	disabled	20000000	9000:0000.cd28.bff9
port1.0.7	128	disabled	disabled	20000000	8000:0000.cd28.bff9
port1.0.8	128	disabled	disabled	20000000	8000:0000.cd28.bff9
port2.0.1	128	disabled	disabled	20000000	9000:0000.cd28.bff9
- Topology Change:**
 - Topology Change: 1
 - Time Since Topology Change: 51 hours 28 minutes 9 seconds

The bottom right corner of the window shows the date and time: 18/12/08 17:50.

**Description:
Switch State**

Label / Field / Button	Description
Switch State / Mode	Spanning Tree Mode displayed: STP (Spanning Tree Protocol), RSTP (Rapid Spanning Tree Protocol), or MSTP (Multiple Spanning Tree Protocol).
Switch State / Status	Status of the Spanning Tree Mode: enabled or disabled.
Switch State / Bridge ID	Bridge ID, comprising the port priority followed by its MAC address.
Switch State / Root ID	Root Bridge ID, comprising the root priority followed by its MAC address.
Switch State / Root Path Cost	Sum of the costs for each path between the bridge port and the root bridge.
Switch State / Max Age	Time in seconds that the dynamic spanning tree configuration information is stored in the switch before it is discarded.
Switch State / Hello Time	Time in seconds between the transmission of switch spanning tree configuration information, when the switch is the Root Bridge of the spanning tree or is trying to become the Root Bridge.
Switch State / Forward Delay	Time in seconds to control how fast a port changes its spanning tree state when moving towards the forwarding state. This value is used only when the switch is acting as the root bridge. Note that Forward Delay, Max Age, and Hello Time are interrelated.

**Description:
Port State**

Label / Field / Button	Description
Port State / Port	Switch port number in the format 'portX.Y.Z' where X is the switch, Y is the XEM, and Z is the individual switch port number.
Port State / Port Priority	The lower the port priority, the higher the likelihood of the port becoming part of the active network topology.
Port State / Port State	Displays the spanning tree state for the port as configured in the CLI with 'spanning-tree' commands. Indicates spanning tree states of: disabled, blocking, listening, learning, and forwarding.
Port State / STP Enabled	Displays whether spanning-tree is enabled or disabled. Spanning tree is enabled by default.
Port State / Port Path Cost	The cost of a path for the port that determine the total cost path. The lower the total cost, the higher the priority of the path.
Port State / Designated Bridge ID	The unique parent for each bridge that connects it to the next LAN on the path towards the root bridge.

**Description:
Topology Change**

Label / Field / Button	Description
Topology Change / Topology Change	The number of STP Topology Changes that have occurred since the switch was rebooted.
Topology Change / Time Since Topology Change	The time in hours and seconds since the previous STP Topology Change occurred.

Resiliency and High Availability > EPSR

The **Resiliency and High Availability > EPSR** menu tab allows you to display the properties and status of any EPSR domains configured on the switch.

You can also sort or rearrange the display of the EPSR Port State table by Node Type, Domain Name, Domain ID, State, Control VLAN, Primary Port, Primary Port Status, Secondary Port, or Secondary Port Status by selecting the relevant column or by dragging the relevant column respectively.

Note EPSR is not configurable through the GUI. Refer to the relevant EPSR chapters in the AlliedWare Plus™ Software Reference to configure EPSR using the CLI instead.



Menu Tab Figure C-41: Example showing the **Resiliency and High Availability > EPSR** menu tab:

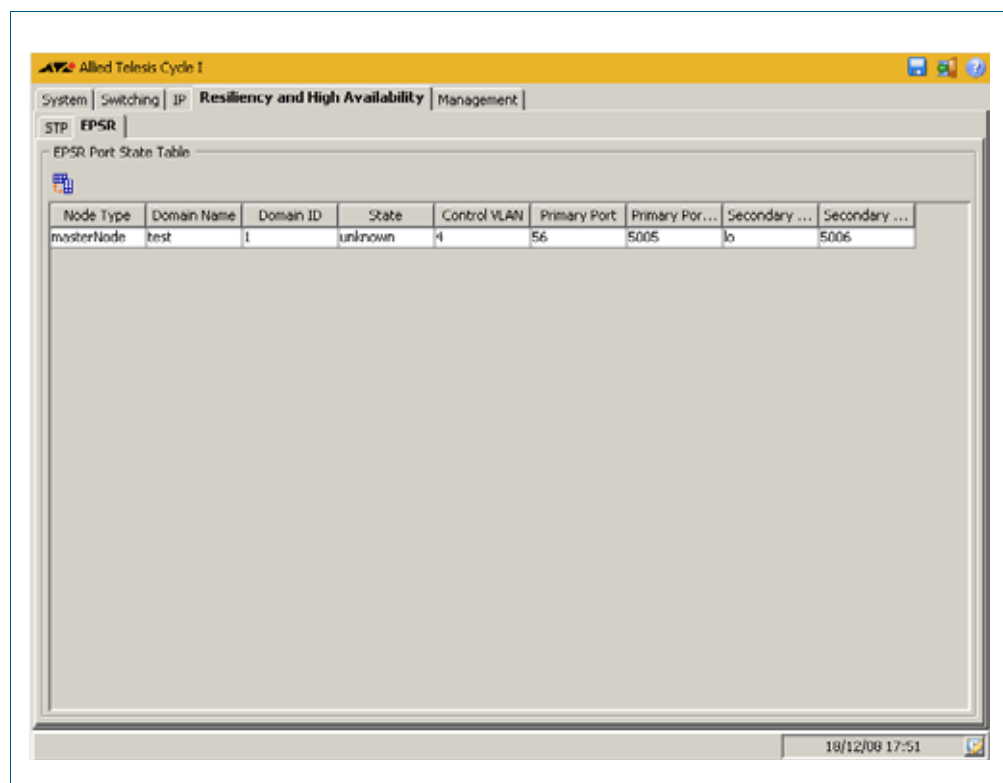

Description

Label / Field / Button	Description
EPSR Port State Table / Node Type	Displays master or transit node as configured in the CLI with the 'epsr mode' command.
EPSR Port State Table / Domain Name	Displays the domain name. A set of instances across a ring is called a domain.
EPSR Port State Table / Domain ID	Displays the assigned domain number for the domain name.
EPSR Port State Table / State	Displays the EPSR state as configured in the CLI with the 'epsr state' commands.

Label / Field / Button	Description (cont.)
EPSR Port State Table / Control VLAN	Displays the control VLAN as configured in the CLI with the 'epsr mode controlvlan' command.
EPSR Port State Table / Primary Port	Displays the master node primary port interface name as configured in the CLI with the 'epsr mode primaryport' command.
EPSR Port State Table / Primary Port Status	Displays the master node primary port interface status: up or down.
EPSR Port State Table / Secondary Port	Displays the assigned secondary port interface name.
EPSR Port State Table / Secondary Port Status	Displays the assigned secondary port interface status: up or down.

Management > Device Utilities

The Management > Device Utilities menu tab allows you to perform pings and reboot the switch from the GUI.

Menu Tab Figure C-42: Example showing the Management > Device Utilities menu tab:

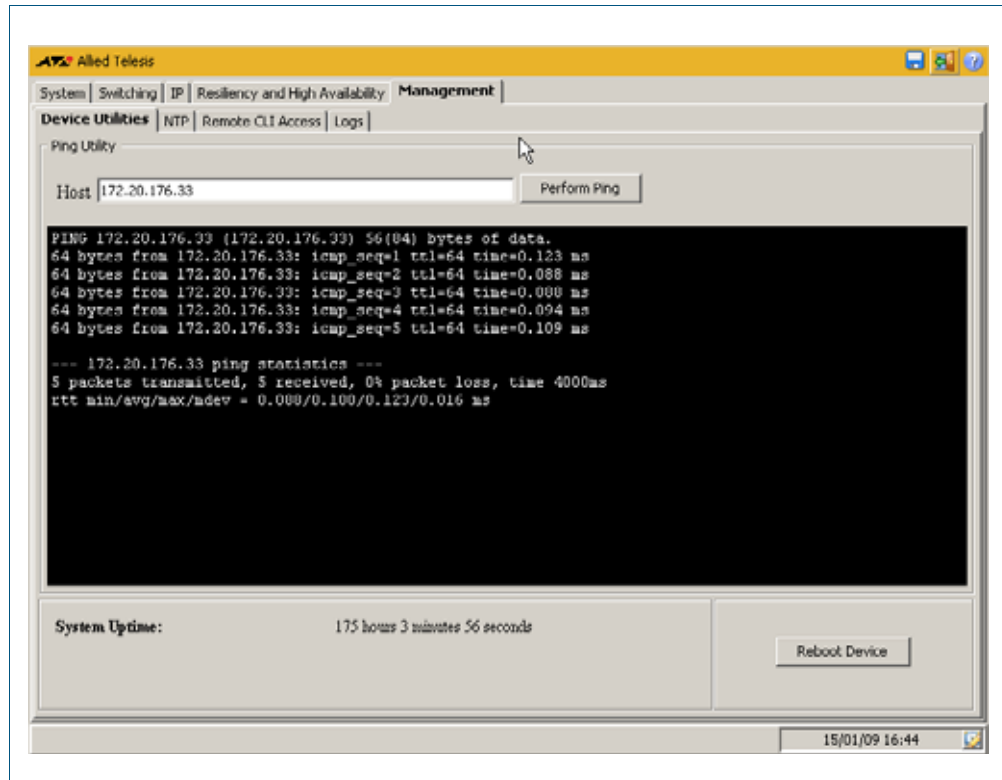

Description

Label / Field / Button	Description
Ping Utility / Host	Enter the IPv4 address or the URL that you want to ping in this field.
Ping Utility / Perform Ping	Select this button to ping the IPv4 address or URL that you entered in the Host field.
System Uptime	Displays the elapsed time since the last reboot in hours, minutes, and seconds.
Reboot Device	Select this button to reboot your switch. You will need to login to the GUI again after you reboot your switch. Rebooting closes all Telnet / SSH / SNMP sessions on your switch.

Management > NTP

The Management > NTP menu tab allows you to display and configure Network Time Protocol (NTP) peer configurations on the switch.

Menu Tab Figure C-43: Example showing the Management > NTP menu tab:

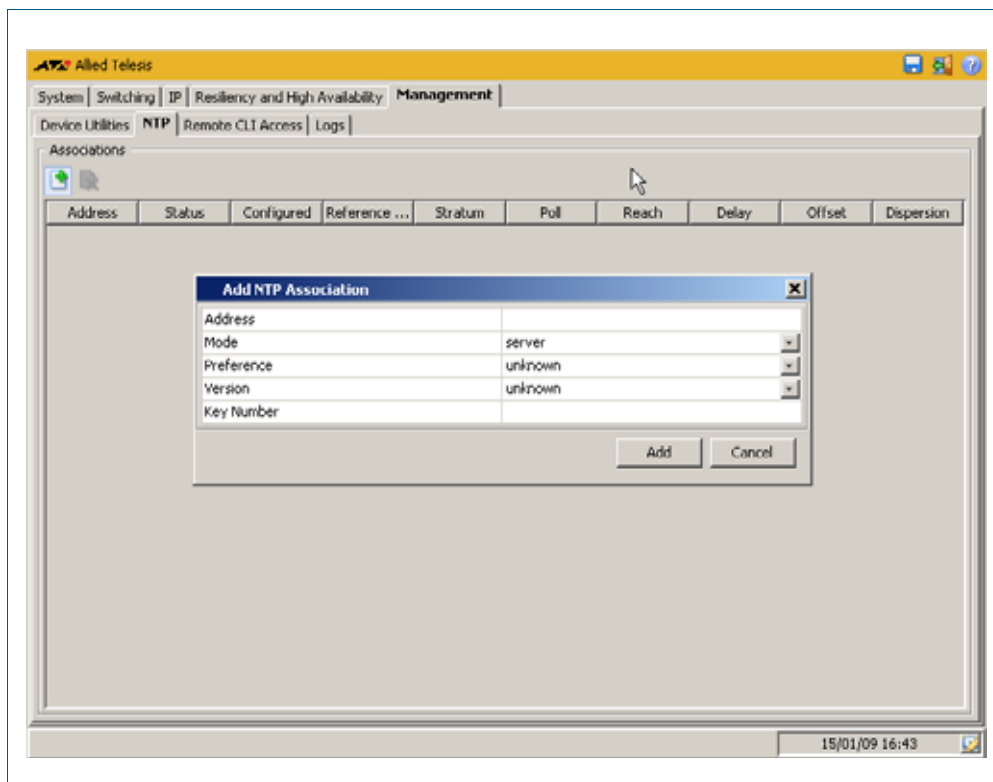

Description

Label / Field / Button	Description
Associations / Address	The NTP peer or NTP server IPv4 address.
Associations / Status	Indicates association status, and displays 'master(synced)', 'master(unsynced)', 'selected', 'candidate', 'configured', or 'unknown'.
Associations / Configured	Indicates if the association is configured or not, and displays 'configured' or 'dynamic'.
Associations / Reference Clock	The IPv4 address for the reference clock.
Associations / Stratum	The number of hops between the server and the accurate time source.
Associations / Reach	Shows whether or not the NTP server responded to the last request, which indicates the reachability of the NTP peer.
Associations / Delay	The round trip delay between the device and the server.

Label / Field / Button	Description (cont.)
Associations / Offset	The difference between the device clock and the server clock, relative to the server clock, in milliseconds.
Associations / Dispersion	The lowest measure of error associated with peer offset based on delay.

Management > NTP > Add NTP Association

The **Management > NTP > Add NTP Association** dialog allows you configure Network Time Protocol (NTP) peer configurations on the switch.

Configuration Dialog

Figure C-44: Example showing the **Management > NTP > Add NTP Association**

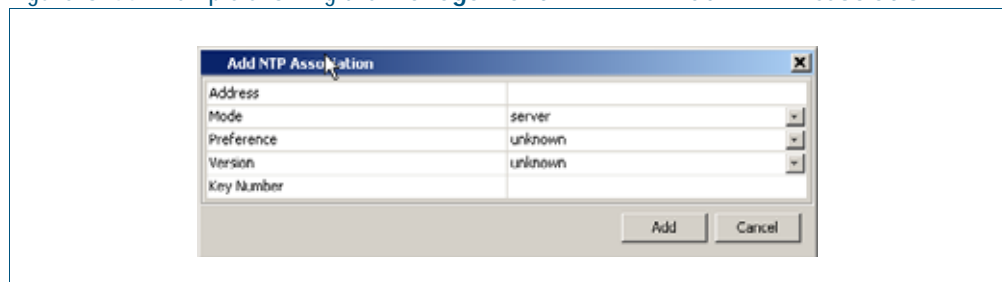

dialog:

Description

Label / Field / Button	Description
Address	Enter the NTP IPv4 address for the NTP peer or NTP server used.
Mode	Select one of the server or peer options from the drop down list to specify the NTP Mode used. When using NTP server mode, the NTP server will not accept updates from clients for updates to the server's time settings. The NTP server is configured to synchronize the NTP clients. When using NTP peer mode, each device shares its time information with the other, and each device can also provide time synchronization to the other.
Preference	Select one of the unknown , not preferred , or preferred options from the drop down list to specify the NTP Preference used. NTP Preference is used to configure an NTP server, so the NTP server is given preference to synchronize the NTP clients.
Version	Select one of the unknown , version 1 , version 2 , version 3 , or version 3 options from the drop down list to specify the NTP Version used.
Key Number	Enter the NTP Key Number for NTP authentication, which allows NTP to authenticate the associations with other systems for security purposes. The NTP Key Number is an integer in the range <1-4294967295>. The MD5 (Message-Digest algorithm 5) key type is supported to encrypt the NTP Key Number used for authentication.

Management > Remote CLI Access

The Management > Remote CLI Access menu tab allows you to enable, disable and configure Telnet and SSH.

You can create Telnet or SSH connections to the switch, and you can view a list of all current active CLI sessions on the switch from this tab.

Menu Tab Figure C-45: Example showing the Management > Remote CLI Access menu tab:

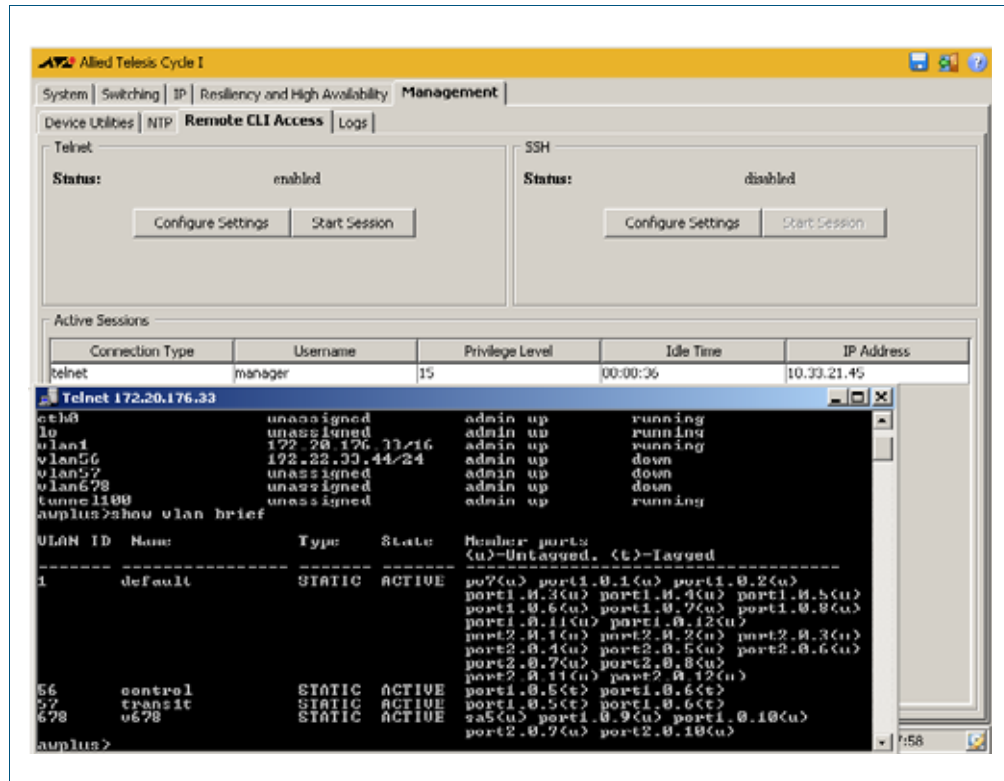

Description

Label / Field / Button	Description
Telnet / Status	Displays the current Telnet status, either 'enabled' or 'disabled'.
Telnet / Configure Settings	Configures the Telnet Status. Select 'enabled' or 'disabled' to configure the status of the Telnet server on the switch.
Telnet / Start Session	Starts a Telnet session to use the CLI. After starting a Telnet session you will need to login to the switch to use the CLI.
SSH / Status	Displays the current SSH status, either 'enabled' or 'disabled'.
SSH / Configure Settings	Configures the SSH Status. Select 'enabled' or 'disabled' to configure the status of the SSH server on the switch. Note that relevant certificates must be installed to initiate an SSH session.
SSH / Start Session	Starts a secure SSH session to use the CLI. After starting an SSH session you will need to login to the switch to use the CLI.

Description

Label / Field / Button	Description
Active Sessions / Connection Type	A Console connection or a VTY connection.
Active Sessions / Username	Login name for a user.
Active Sessions / Privilege Level	The privilege set for a user for VTY or console connection. Privilege levels range from 1-15 with 15 the highest privilege level. Privilege levels are used in the CLI to enable or disable access to different configuration modes and commands. Privilege levels 1-14 only enables users to view system configuration and system behavior. Privilege level 15 enables users to globally configure all the interfaces on a switch.
Active Sessions / Idle Time	Time in seconds that the SSH Server waits to receive data from the SSH Client. The SSH Server disconnects when the Idle Time limit is reached.
Active Sessions / IP Address	The IPv4 address for the VTY connection.

Management > Remote CLI Access > Telnet Settings

The **Management > Remote CLI Access > Telnet Settings** dialog allows you to enable or disable Telnet.

Configuration Dialog Figure C-46: Example showing **Management > Remote CLI Access > Telnet Settings** dialog:

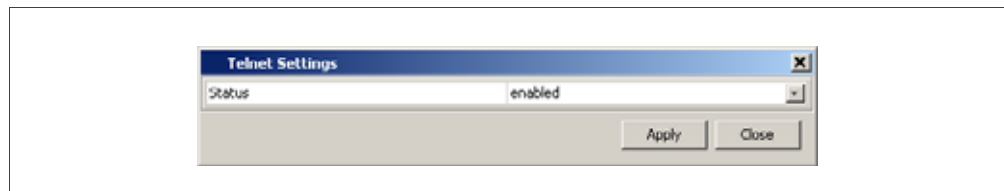

Description

Label / Field / Button	Description
Status	Select enabled or disabled from the drop down list on this dialog to enable or disable Telnet respectively on the switch.

Management > Remote CLI Access > SSH Settings

The Management > Remote CLI Access > SSH Settings dialog allows you to enable or disable SSH.

Configuration Dialog Figure C-47: Example showing the **Management > Remote CLI Access > SSH Settings** dialog:

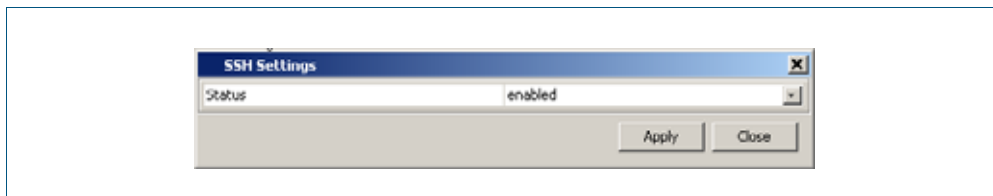

Description

Label / Field / Button	Description
Status	Select <code>enabled</code> or <code>disabled</code> from the drop down list on this dialog to enable or disable SSH respectively on the switch.

Management > Logs

The Management >Logs menu tab allows you to view the switch logs, and export the switch logs as .csv format files.

Menu Tab Figure C-48: Example showing the Management > Logs menu tab:

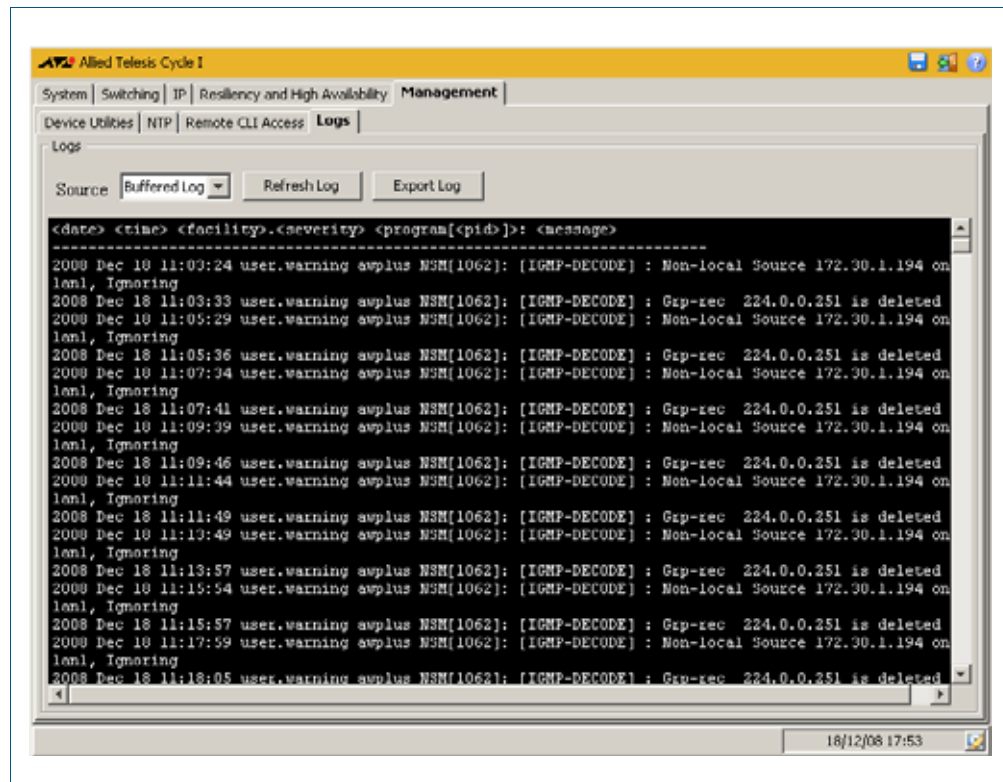

Description

Label / Field / Button	Description
Logs	Display, select and export the available switch log files for troubleshooting use.
Source	Select the buffered log or the permanent log available on the switch to display or export to a .csv format file for use in a spreadsheet.
Source / Refresh Log	Select this button to display an updated buffered or permanent log.
Source / Export Log	Select this option to export the log to a .csv format file for use in a spreadsheet.

Management > Logs > Export Logs

The Management > Logs > Export Logs dialog allows you to export the switch logs as .csv format files.

Configuration Dialog

Figure C-49: Example showing the Management > Logs > Export Logs dialog:

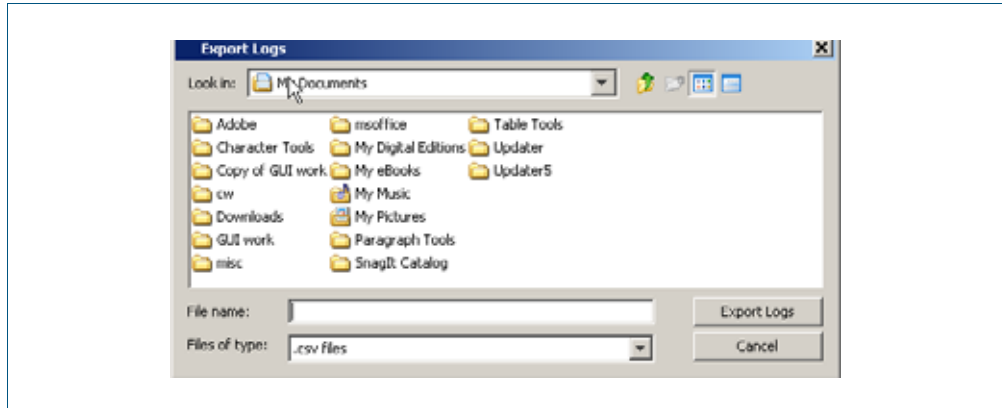

Description

Label / Field / Button	Description
File name:	Enter the file name for the exported log file.
Files of type:	Select .csv files to export the log file as a comma separated file, so each column of the log file can be formatted in a spreadsheet.

Appendix D: Glossary



Numerics	D.2
A	D.2
B	D.5
C	D.7
D	D.9
E	D.11
F	D.12
G	D.12
H	D.12
I	D.13
J	D.14
K	D.14
L	D.15
M	D.16
N	D.18
O	D.19
P	D.19
Q	D.22
R	D.22
S	D.25
T	D.28
U	D.29
V	D.29
W	D.31
X	D.31
Y	D.31
Z	D.31

Numerics

6to4 automatic tunneling

IPv6 transition is required to migrate from IPv4 to IPv6. One method to connect to the global IPv6 network over the existing IPv4 network is called 6to4 automatic tunneling. Although this method is called '6to4 tunneling', it does not involve discrete point-to-point tunnels. The 'tunneling' in '6to4 tunneling' refers to the fact that the IPv6 packets are encapsulated in IPv4 packets to be 'tunneled' across the IPv4 domain. Hence, '6to4 tunneling' is primarily a scheme for encapsulating IPv6 packets inside IPv4 headers.

For more information and a configuration example see "[6to4 Automatic Tunnel Configuration](#)" on page 26.2.

802.1X

IEEE 802.1x is an IEEE Standard for port-based Network Access Control (NAC). It is part of the IEEE 802.1 group of networking protocols. It provides an authentication mechanism to devices wishing to attach to a LAN, either establishing a point-to-point connection or preventing it if authentication fails. It is used for securing wireless 802.11 access points and is based on the Extensible Authentication Protocol (EAP). Authentication is required on a per-port basis. The main components of an 802.1X implementation are:

- The authenticator - the port on this device that wishes to enforce authentication before allowing access to services that are accessible behind it.
- The supplicant - the port that wishes to access services offered by the authenticator's system. The supplicant may be a port on a PC or other device connected to this device.
- The authentication server - a device that uses the authentication credentials supplied by the supplicant, via the authenticator, to determine if the authenticator should grant access to its services.

See [AAA](#) and [tri-authentication](#).

For a configuration example see "[Configuring 802.1X](#)" on page 54.2. For a sample configuration script see "[Sample 802.1X Authentication Configuration](#)" on page 58.6.

A

AAA

AAA is the collective title for the three related functions of Authentication, Authorization and Accounting. These function can be applied in a variety of methods with a variety of servers.

Authentication is performed in the following contexts:

- Login authentication of user shell sessions on the console port, and via telnet/SSH.
- [802.1X](#) authentication of devices connecting to switch ports.
- [MAC authentication](#) of devices connecting to switch ports.
- [Web-authentication](#) of devices connecting to switch ports.

Accounting is performed in the following contexts:

- [Accounting of console login sessions.](#)
- [Accounting of 802.1x authenticated connections.](#)
- [Accounting of MAC authenticated connections.](#)
- [Accounting of Web authenticated connections.](#)

There are two types of servers that can be used:

- [Local user database.](#)
- [RADIUS servers.](#)

When 802.1X authentication, MAC authentication and Web-authentication are configured to run simultaneously on a switch port this is called tri-authentication.

For more information see [Chapter 58, AAA Introduction and Configuration](#). For a configuration example see [“Configuring AAA Login Authentication” on page 58.4](#). For sample 802.1x, MAC authentication and Web-authentication configuration scripts see [“Sample Authentication Configurations” on page 58.6](#).

access-list

See [ACL](#).

ACL

Access Control List. An ACL is one filter, or a sequence of filters, that are applied to an interface to either block, pass, or when using QoS, apply priority to, packets that match the filter definitions. ACLs are used to restrict network access by hosts and devices and to limit network traffic. See [ACL sequence numbers](#) and [ACL types](#).

For more information see [Chapter 49, Access Control Lists Introduction](#).

ACL sequence numbers

To help manage [ACLs](#) you can apply sequence numbers to filters. This allows you to remove filters from named and numbered ACLs without having to reconfigure an ACL. The ability to add sequence numbers to filters simplifies updates through the ability to position a filter within an ACL. When you add a new filter, you can specify a sequence number to position the filter in the ACL and you can also remove a current filter in an ACL by specifying a sequence number.

For more information see [“ACL Sequence Number Support” on page 49.4](#).

ACL types

[ACLs](#) are separated into two different types, software ACLs and hardware ACLs.

Hardware ACLs are applied directly to an interface, or are used for QoS [classifications](#). They can be either named, or can use the following numeric ranges:

- [3000-3699 for Hardware IP ACLs](#)
- [4000-4699 for Hardware MAC ACLs](#)

For more information see [“Hardware IP ACLs” on page 49.17](#) and [“Hardware MAC ACLs” on page 49.16](#).

Software ACLs can be either named ACLs, using the standard or extended keyword followed by a text string, or they can use the following numeric ranges:

- 1-99
- 100-199
- 1300-1999
- 2000-2699

Software ACLs are used in features such as SNMP, IGMP, BGP and OSPF.

ARP

Address Resolution Protocol. ARP is used by your device to dynamically learn the layer 2 address of devices in its networks. Most hosts also have a MAC physical address in addition to the assigned IP address. For Ethernet, this is a 6-byte, globally unique number. ARP enables your device to learn the physical address of the host that has a given IP address.

For more information see [“Address Resolution Protocol \(ARP\)” on page 22.3.](#)

AS

Autonomous System. A group of networks with a common routing infrastructure. An AS runs interior gateway protocols (IGPs) such as [RIP](#) and [OSPF](#) within its boundaries and uses exterior gateway protocols (EGPs) such as [BGP](#) to exchange routing information with other ASs.

ASIC

Application Specific Integrated Circuit. An integrated circuit (chip) manufactured to perform a specific function.

autonegotiation

Autonegotiation lets the port adjust its speed and duplex mode to accommodate the device connected to it. When the port connects to another autonegotiating device, they negotiate the highest possible speed and [duplex mode](#) for both of them.

autonomous system

See [AS](#).

B

BGP

Border Gateway Protocol. BGP is an exterior gateway protocol that determines the best path in networks, performs optimal routing between multiple autonomous systems or domains, and exchanges routing information with other BGP systems. The RFCs 1771 (BGP4), 1654 (first BGP4 specification), and 1105, 1163, 1267 (older version of BGP) describe BGP and BGP4.

For more information see [“BGP” on page 28.3](#). For configuration examples see [“Enabling BGP Peers In The Same Autonomous System” on page 37.2](#), [“Enabling BGP Between Different Autonomous Systems” on page 37.3](#), [“Route Reflector” on page 37.5](#), [“Confederations” on page 37.7](#), [“BGP Authentication” on page 37.10](#), [“Configuring BGP Graceful Reset” on page 37.12](#) and [“Configuring BGP Graceful Restart” on page 37.14](#).

BGP filter types

There are four filter types that can be applied to the BGP updates being exchanged between BGP peers:

- **Distribute filters** - these use ACLs and look at the individual prefixes within an update message. If a prefix within the update message matches the filter criteria then that individual prefix is filtered out or accepted depending on what action the filter entry has been configured to carry out. Note that you cannot combine distribute filters and prefix filters.
- **Path filters** - these look at the AS-Path attribute in update messages. If the AS-Path attribute in the update matches the filter criteria then the whole update message is filtered out or accepted, depending on what action the filter entry has been configured to carry out.
- **Prefix filters** - these use prefix lists and look at the individual prefixes within an update message. If a prefix within the update message matches the filter criteria then that individual prefix is filtered out or accepted depending on what action the filter entry has been configured to carry out. Note that you cannot combine distribute filters and prefix filters.
- **Route maps** - these have a complex combination of match criteria and actions. They can be used to filter out routes and also to alter the attributes in update messages.

All these filter types can be used in incoming or outgoing directions. So, all the filters can all be used to filter the update packets that are received from a peer, or the update packets which the router itself is sending to a peer.

BGP peers

Within the BGP protocol, the exchange of routing information is carried out between pairs of routers. Two routers create a TCP connection with each other, and exchange routing information as specific data packets within that TCP session. The routers at the ends of the TCP connection are referred to as BGP peers. Any given router can form peering relationships with multiple routers.

BGP updates

Once a router has established a BGP connection with a peer, it will start to exchange routing information with that peer. A BGP update message is the packet that is used to transfer the routing information.

BIST

Built In Self Test. A mechanism that permits the device to test itself.

B-MAC

Backbone MAC address.

BPDU

Bridge Protocol Data Unit. A [spanning tree](#) protocol initializing packet sent at configurable intervals to exchange information among bridges in the LAN.

For information on the standardized format for MSTP BPDU messages see [“MSTP Bridge Protocol Data Units \(BPDUs\)” on page 18.16.](#)

bridge

A device that connects two or more networks and forwards packets between them. Bridges function at the data link layer or Layer 2 of the OSI reference model. A bridge will filter, send or flood an incoming frame, base on the MAC address of that frame.

broadcast

One device sends out data that is intended to be received and processed by every device that it reaches.

broadcast domain

A section of an Ethernet network comprising all the devices that will receive broadcast packets sent by any device in the domain. Separated from the rest of the network by a Layer 3 switch.

BOOTP

Bootstrap Protocol. BOOTP is a UDP-based protocol that enables a booting host to dynamically configure itself without external interventions. A BOOTP server responds to requests from BOOTP clients for configuration information, such as the IP address the client should use.

B-TAG

Backbone TAG Field.

B-VID

Backbone VLAN ID (tunnel).

B-VLAN

Backbone VLAN (tunnel).

C

CHAP

Challenge Handshake Authentication Protocol. CHAP is an authentication method used by PPP servers to validate the identity of clients. CHAP verifies the identity of the client by using a three-way handshake, and the verification is based on a shared secret by the client and the server, such as the client's password.

CIST

Common and Internal Spanning Tree. The CIST is the default spanning tree instance of [MSTP](#), i.e. all VLANs that are not members of particular [MSTIs](#) are members of the CIST. Also, an individual MST region can be regarded as a single virtual bridge by other MST regions. The spanning tree that runs between regions is the CIST. The CIST is also the spanning tree that runs between MST regions and Single Spanning Tree (SST) entities.

For more information see [“Common and Internal Spanning Tree \(CIST\)” on page 18.14.](#)

classification

In [ACLs](#) and [QoS](#), classification is the process of filtering and marking. Filtering involves sorting your data into appropriate traffic types. Marking involves tagging the data so that downstream ports and routers can apply appropriate service policy rules. There are two reasons to classify data:

- To provide network security (security ACLs).
- To apply service quality criteria QoS.

The main application of security ACLs is to block undesired traffic. When using ACLs though QoS, the same classification and action abilities are available, but QoS has some additional fields that it can match on and also provides the ability to perform metering, marking and remarking on packets that match the filter definitions.

For more information on ACL classification see [“Profile Limitations” on page 49.13.](#) For more information on QoS classification see [“Classifying your Data” on page 52.7.](#)

class maps

Class maps are among the pivotal [QoS](#) components. They provide the means that associate the classified traffic with its appropriate QoS actions. They are the linking elements for the following functions:

- [classification.](#)
- [policy mapping.](#) See [policy maps.](#)
- [aggregate policing and metering](#)
- [premarking.](#)

The relationship between a class map and a policy map can be one-to-one or many-to-one.

For more information see [“Class Maps” on page 52.7.](#)

CLI

Command Line Interface. With three distinct modes, the CLI is very secure. In User exec mode you can view settings and troubleshoot problems but you cannot make changes to the system. In Privileged exec mode you can change system settings and restart the device. You can only make configuration changes in Global configuration mode, which reduces the risk of making accidental configuration changes.

For more information see [“How to Work with Command Modes” on page 1.9](#) and [“Commands Available in each Mode” on page 1.37](#).

C-MAC

Customer MAC Address.

collision domain

A physical region of a local area network (LAN) in which data collisions can occur.

Control Plane Prioritization

Control Plane Prioritization (CPP) allows you to allocate priorities to packet types to ensure minimum interruption to the flow of control information through the network. CPP stops the control plane from being flooded by traffic in the event of a network storm or Denial of Service (DoS) attack. This ensures maximal performance and prevents network outages. In addition, with CPP you can also limit the amount of traffic that flows to the CPU to ensure that performance of other services, such as the CLI, are not affected during network storms or DoS attacks.

control VLAN

In [EPSR](#), the VLAN over which all control messages are sent and received. EPSR never blocks this VLAN.

For more information see [“Ring Components and Operation” on page 71.2](#).

CoS

Class of Service. CoS is a method of classifying traffic on a packet by packet basis using information in the type-of-service (ToS) byte to provide different service levels to different traffic. See [QoS](#).

For more information see [“CoS to egress queue premarking” on page 52.12](#).

cost

An indication of the overhead required to send packets across a certain interface.

CPP

Control Plane Prioritization. See [Control Plane Prioritization](#).

C-TAG

Customer VLAN TAG.

C-VID

Customer VLAN ID.

C-VLAN

Customer VLAN.

D

data VLAN

In [EPSR](#), a VLAN that needs to be protected from loops. Each EPSR domain has one or more data VLANs.

For more information see [“Ring Components and Operation” on page 71.2](#).

designated bridge

Each bridge or LAN in the [spanning tree](#), except the [root bridge](#), has a unique parent, known as the designated bridge. Each LAN has a single bridge, called the designated bridge, that connects it to the next LAN on the path towards the root bridge.

For an overview of spanning tree operation see [“Spanning tree operation” on page 18.2](#).

DHCP

Dynamic Host Configuration Protocol. A method of automatically allocating IP addresses. A DHCP server holds a pool of IP addresses from which it draws individual ones as it allocates them to users when they log on.

For more information see [Chapter 75, Dynamic Host Configuration Protocol \(DHCP\) Introduction](#).

DHCP relay agents

DHCP relay agents pass BOOTP and DHCP messages between servers and clients. Networks where the DHCP or BOOTP server does not reside on the same IP subnet as its clients need the intermediate routers to act as relay agents.

DHCP snooping

DHCP snooping provides an extra layer of security on the switch via dynamic IP source filtering. DHCP snooping filters out traffic received from unknown, or ‘untrusted’ ports, and builds and maintains a DHCP snooping database.

With DHCP snooping, IP sources are dynamically verified, and filtered accordingly. IP packets that are not sourced from recognized IP addresses can be filtered out. This ensures the required traceability.

For more information see [Chapter 67, DHCP Snooping Introduction](#). For a configuration example see [“Configure DHCP Snooping” on page 67.10](#).

DLF

Destination Lookup Failure. DLF is the event of receiving a unicast Ethernet frame with an unknown destination address.

DNS

Domain Name System. DNS allows you to access remote systems by entering human-readable device host names rather than IP addresses. DNS works by creating a mapping between a device name, such as `gwww.alliedtelesis.comh`, and its IP address. These mappings are held on DNS servers. The benefits of DNS are that domain names:

- Can map to a new IP address if the host's IP address changes.
- Are easier to remember than an IP address.
- Allow organizations to use a domain name hierarchy that is independent of any IP address assignment.

For more information see [“Domain Name System \(DNS\)” on page 22.8](#).

DoS

Denial of Service. A generic term for attacks that reduce or stop the operation of a network.

DSCP value

The Differentiated Services Code Point within the TOS field of an IP packet header. This is a 6-bit number in the range 0-63.

duplex mode

See [full duplex](#) and [half duplex](#).

dynamic channel group

A dynamic channel group also known as a LACP channel group, an etherchannel, or a LACP aggregator, enables a number of ports to be dynamically combined to form a single higher bandwidth logical connection. See [LACP](#).

For an more information see [“Link Aggregation Control Protocol \(LACP\)” on page 20.2](#). For a configuration example see [“Configuring A LACP Channel Group” on page 20.3](#).

Dynamic Link Failover

Dynamic Link Failover (Host Attach) is a versatile feature that enables devices that do not support link aggregation to form multiple active links by using [triggers](#) and [scripts](#). You can customize Dynamic Link Failover to suit almost any situation, from a simple redundant backup link to multiple active links capable of basic load-sharing.

E

EAP

Extensible Authentication Protocol. EAP carries out the authentication exchange between the supplicant and the authentication server.

etherchannel

See [dynamic channel group](#).

Ethernet Protection Switching Ring

See [EPSR](#).

EPSR

EPSR (Ethernet Protection Switching Ring) operates on physical rings of switches (note, not on meshed networks). When all nodes and links in the ring are up, EPSR prevents a loop by blocking data transmission across one port. When a node or link fails, EPSR detects the failure rapidly and responds by unblocking the blocked port so that data can flow around the ring. The EPSR components are:

- [EPSR domain](#)
- [master node](#)
- [transit node](#)
- [ring port](#)
- [primary port](#)
- [secondary port](#)
- [control VLAN](#)
- [data VLAN](#)

For more information and example configurations see [Chapter 71, EPSR Introduction](#).

EPSR domain

A protection scheme for an Ethernet ring that consists of one or more data VLANs and a control VLAN.

For more information see [“Ring Components and Operation” on page 71.2](#).

EGP

Exterior Gateway Protocol. EGP is an obsolete protocol that has been replaced by [BGP](#). Not to be confused with the general term exterior gateway protocol.

egress

Outgoing packet process.

exterior gateway protocol

A protocol that distributes routing information to devices that connect separate autonomous systems (ASs).

F

FDB

Forwarding Database.

FIB

Forwarding Information Base. The [RIB](#) (Routing Information Base) populates the FIB with the best route to each destination. When your device receives an IP packet, and no filters are active that would exclude the packet, it uses the FIB to find the most specific route to the destination. If your device does not find a direct route to the destination, and no default route exists, it discards the packet and sends an ICMP message to that effect back to the source.

For more information see [“RIB and FIB Routing Tables” on page 29.4](#).

full duplex

When a port is in full duplex mode, the port transmits and receives data simultaneously. See [half duplex](#).

G

Guest VLAN

If [802.1X](#) authentication has been configured on access ports in the network, you might still want to provide limited network access to those users whose devices do not have 802.1x supplicant enabled, or who have unrecognized authentication credentials. The mechanism to achieve this is known as a Guest VLAN. The idea is that if the users device fails 802.1X authentication, or is not even performing any 802.1X authentication, then its connection port can be put into the guest VLAN.

For more information see [“Guest VLAN Enhancements” on page 56.10](#) and the [auth guest-vlan command on page 57.8](#). For a configuration example see [“Configuring a Guest VLAN” on page 56.3](#).

H

half duplex

When a port is in half duplex mode, the port transmits or receives but not both at the same time. See [full duplex](#).

hardware ACLs

See [ACL types](#).

I

ICMP

Internet Control Message Protocol. ICMP allows networking devices to send information and control messages to other devices or hosts.

For more information see [“Internet Control Message Protocol \(ICMP\)” on page 22.10](#).

ICMPv6

Internet Control Message Protocol Version 6. ICMPv6 is an implementation of [ICMP](#) for IPv6.

For more information see [“The Internet Control Message Protocol \(ICMPv6\)” on page 24.8](#).

IGMP

Internet Group Management Protocol. IGMP is a communications protocol that hosts use to indicate that they are interested in receiving a particular multicast stream.

IGMP querier or router

A device in a subnetwork that is the coordinator for all multicast streams and IGMP membership information. Each subnet only has one active querier.

IGMP snooper

A device that spies on IGMP messages to create flow efficiencies by ensuring that multicast data streams are only sent to interested ports. A snooper can decide on the best path to send multicast packets at Layer 2 but does not initiate any IGMP communications.

For a configuration example see [“Configuring IGMP snooping” on page 41.3](#).

IGP

Interior Gateway Protocol. A routing protocol used within an autonomous system ([AS](#)).

ingress

Incoming packet process.

interior gateway protocol

See [IGP](#).

IP directed broadcast

An IP directed broadcast is an IP packet whose destination address is a broadcast address for some IP subnet, but originates from a node that is not itself part of that destination subnet. When a directed broadcast packet reaches a switch that is directly connected to its destination subnet, the packet is flooded as a broadcast on the destination subnet. IP directed broadcast is enabled and disabled per VLAN interface. When enabled a directed broadcast packet is forwarded to an enabled VLAN interface if received on another subnet.

IP helper

The IP Helper feature allows the switch to receive UDP broadcasts on one subnet, and forward them as broadcasts or unicasts into another subnet, so a client can use an application which uses UDP broadcast (such as Net-BIOS) when the client and server are located in different subnets. The IP Helper feature forwards UDP broadcast network traffic to specific hosts on another subnet and/or to the broadcast address of another subnet. When the IP Helper feature is enabled on a VLAN interface, the UDP broadcast packets received on the interface are processed for forwarding out through another interface into another subnet.

IRDP

ICMP Router Discovery Protocol. If this feature is configured, the device sends router advertisements periodically and in response to router solicitations. ICMP Router Discovery messages let routers automatically advertise themselves to hosts.

For more information see [“ICMP Router Discovery Protocol \(IRDP\)” on page 22.11.](#)

I-SID

Extended Service ID.

ISP

Internet Service Provider. An organization that offers its customers access to the Internet. The ISP connects its customers using a data transmission technology, such as dial-up or DSL etc.

I-TAG

Extended Service TAG.

J

K

L

LACP

Link Aggregation Control Protocol. LACP allows bundling of several physical ports to form a single logical channel providing enhanced performance and redundancy. The aggregated channel is viewed as a single link to each switch. The spanning tree views the channel as one interface and not as multiple interfaces. When there is a failure in one physical port, the other ports stay up and there is no disruption. LACP does not interoperate with devices that use Port Aggregation Protocol (PAgP).

For an more information see [“Link Aggregation Control Protocol \(LACP\)” on page 20.2](#). For a configuration example see [“Configuring A LACP Channel Group” on page 20.3](#).

LACP aggregator

See [dynamic channel group](#).

LACP channel group

See [dynamic channel group](#).

Layer 3 switch

A Layer 3 switch is an optimized combination of routing software and specialized hardware. The software uses traditional methods (static routing commands, and routing protocols) to build up a table of the best routes to network destinations, and then writes them into a set of registers in the specialized forwarding hardware. The hardware then forwards packets, based on their Layer 3 address content, at very high data rates, using the values that are written into the registers.

LLDP

Link Layer Discovery Protocol. LLDP is a Layer 2 protocol that enables Ethernet network devices, such as switches and routers, to transmit and/or receive device-related information to or from directly connected devices on the network, and to store such information learned about other devices. LLDP is a link level (“one hop”) protocol; LLDP information can only be sent to and received from devices that are directly connected to each other, or connected via a hub or repeater. Advertised information is not forwarded on to other devices on the network.

For more information see [Chapter 80, LLDP Introduction](#). For configuration examples see [“Configuring LLDP” on page 80.11](#).

LLDPDU

LLDP Data Unit. See [LLDP advertisements](#).

LLDP advertisements

LLDP transmits advertisements as packets called LLDP Data Units (LLDPDUs). An LLDPDU consists of a set of Type-Length-Value elements (TLV), each of which contains a particular type of information about the device or port transmitting it.

LLDP-MED

Link Layer Discovery Protocol Media Endpoint Discovery. LLDP-MED is an enhancement to IEEE's 802.1AB LLDP, adding media and IP telephony-specific messages that can be exchanged between the network and endpoint devices.

For more information see [“LLDP-MED” on page 80.3](#), [“LLDP-MED: Location Identification TLV” on page 80.7](#) and [“LLDP-MED Operation” on page 80.9](#). For the procedure to configure LLDP-MED see [“Configure LLDP-MED” on page 80.14](#).

Local RADIUS Server

Local RADIUS Server provides a user authentication service feature.

For more information and configuration examples see [Chapter 62, Local RADIUS Server Introduction and Configuration](#).

LSA

Link State Advertisement. OSPF sends link-state advertisements (LSAs) to all other routers within the same hierarchical area. Data on attached interfaces, metrics used, and other variables, are included in OSPF LSAs. As OSPF routers accumulate link-state data, they use the Shortest Path First (SPF) algorithm to calculate the shortest path to each node.

M

MAC address learning

A key optimization in Ethernet switching is that the flooding of unicast traffic is minimized. This is based on switches knowing which port to forward traffic to for given destination MAC addresses. Switches achieve this by the simple process of noting on which ports packets arrive from given MAC addresses, as those will be the ports to which return packets to those MAC addresses will need to be forwarded. This process is referred to as MAC address learning.

MAC authentication

The way that MAC-based authentication works is that when the supplicant device starts sending packets, the authenticating switch will extract the source MAC address from the packets, and send a RADIUS request that uses this MAC address as the username and password in the request. See [AAA](#) and [tri-authentication](#).

For a sample configuration script see [“Sample MAC Authentication Configuration” on page 58.7](#).

master node

In [EPSR](#), the controlling node for a domain, responsible for polling the ring state, collecting error messages, and controlling the flow of traffic in the domain.

Master node states are:

- Complete - the state when there are no link or node failures on the ring.
- Failed - the state when there is a link or node failure on the ring. This state indicates that the master node received a Link-Down message or that the failover timer expired before the master node's secondary port received a Health message.

For more information see [“Ring Components and Operation” on page 71.2](#).

MD5

Message Digest 5 authentication algorithm.

metering

See [policing](#).

metric

The sum of all the costs along the path to a given destination. See [cost](#).

MLD

Multicast Listener Discovery. MLD is used to exchange membership status information between IPv6 routers that support multicasting and members of multicast groups on a network segment. Host membership in a multicast group is reported by individual member hosts, and membership status is periodically polled by multicast routers.

MLD snooping

MLD snooping is a feature whereby a Layer 2 switch listens to or “snoops” the MLD messages passing through the switch or from member hosts and multicast routers. The purpose of MLD snooping is to provide efficient Layer 2 multicast forwarding, by sending only to hosts that have expressed an interest in receiving the multicast data.

For more information see [Chapter 48, MLD Snooping Commands](#).

MSTI

Multiple Spanning Tree Instance. [MSTP](#) enables the grouping and mapping of VLANs to different spanning tree instances. An MST Instance (MSTI) is a particular set of VLANs that are all using the same spanning tree.

For more information see [“Multiple Spanning Tree Instances \(MSTI\)” on page 18.11](#).

MSTP

Multiple Spanning Tree Protocol. MSTP is similar to Rapid Spanning Tree Protocol ([RSTP](#)) - it provides loop resolution and rapid convergence. However it also has the extra advantage of making it possible to have different forwarding paths for different multiple spanning tree instances. This enables load balancing of network traffic across redundant links. A device running MSTP is compatible with other devices running RSTP or [STP](#).

For more information see [“Multiple Spanning Tree Protocol \(MSTP\)” on page 18.10](#). For a configuration example see [“Configuring MSTP” on page 18.18](#).

MSTP Regions

An MST region is a set of interconnected switches that all have the same values for the following MST configuration identification elements:

- MST configuration name - the name of the MST region.
- Revision level - the revision number of configuration.
- Configuration Digest - the mapping of which VLANs are mapped to which MST instances.

Each of the MST instances created are identified by an **MSTI** number. This number is locally significant within the MST region. Therefore, an MSTI will not span across MST regions.

For more information see [“MSTP Regions” on page 18.12](#).

multicast

One device sends out data that is intended to be received and processed by a selected group of the devices it reaches.

N

NAC

Network Access Control. NAC provides unprecedented control over user access to the network in order to mitigate threats to network infrastructure. NAC uses **802.1X** port-based authentication with standards-compliant dynamic VLAN assignment, to assess a user's adherence to the network's security policies, and either grant authentication or offer remediation. NAC also supports alternatives to 802.1x port-based authentication, such as **Web-authentication** to enable guest access, and **MAC authentication** for end points that do not have an 802.1x supplicant. Furthermore, if multiple users share a port then multi-authentication can be used and a **Guest VLAN** can be configured to provide a catch-all for users without an 802.1x supplicant.

For more information see [Chapter 54, 802.1X Configuration](#) and [Chapter 56, Authentication Configuration](#).

NAS

Network Access Server. A NAS is a single point of access to a remote resource. The client connects to the NAS. The NAS then connects to another resource asking whether the client's supplied credentials are valid. Based on that answer the NAS then allows or disallows access to the resource. The NAS contains no information about what resources clients can connect to or what client credentials are valid. The NAS sends the credentials the client supplied to a resource which then validates the client.

next hop

IP routing involves forwarding packets from one router to the next, until they reach their destination. Routers do not need to know the full path to a packet's destination, they just need to know the next router to forward the packet on to. This 'next router' is referred to as the next hop of an IP route.

Nested VLAN

See [VLAN double tagging](#).

NTP

Network Time Protocol. NTP is a protocol for synchronizing the time clocks on a collection of network devices using a distributed client/server mechanism.

For more information see [Chapter 73, NTP Introduction](#).

O

OSPF

Open Shortest Path First. A link-state routing protocol, OSPF is an interior gateway protocol (IGP) that uses the Shortest Path First (SPF) Dijkstra algorithm.

For more information see [Chapter 35, OSPF Configuration](#). For configuration examples see [“Enabling OSPF on an Interface” on page 35.3](#), [“Setting priority” on page 35.5](#), [“Configuring an Area Border Router” on page 35.7](#), [“Redistributing Routes Into OSPF” on page 35.8](#), [“OSPF Cost” on page 35.9](#), [“Configuring Virtual Links” on page 35.12](#) and [“OSPF Authentication” on page 35.14](#).

P

PAP

Password Authentication Protocol. PAP is an authentication protocol that uses a password and is used by PPP to validate users before allowing them to access server resources. PAP transmits plain text ASCII passwords over the network so it is not secure.

PIM-DM

Protocol Independent Multicast - Dense Mode. PIM-DM is a data-driven multicast routing protocol, which builds source-based multicast distribution trees that operate on the Flood-and-Prune principle. It requires unicast-reachability information, but does not depend on a specific unicast routing protocol. PIM-DM is a significantly less complex protocol than PIM-SM. PIM-DM works on the principle that it is probable that any given multicast stream will have at least one downstream listener. PIM-DM is ideal where many hosts subscribe to receive multicast packets, so most of the PIM Routers receive and forward all multicast packets.

For more information see [Chapter 46, PIM-DM Configuration](#). For a configuration example see [“PIM-DM Configuration” on page 46.4](#).

PIM-SM

Protocol Independent Multicast - Sparse Mode. PIM-SM provides efficient communication between members of sparsely distributed groups - the type of groups that are most common in wide-area internetworks. PIM-SM is designed on the principle that several hosts wishing to participate in a multicast conference does not justify flooding the entire internetwork with periodic multicast traffic. PIM-SM is designed to limit multicast traffic so that only those routers interested in receiving traffic for a particular group receive the traffic.

For more information see [Chapter 44, PIM-SM Configuration](#). For configuration examples see [“Static Rendezvous Point configuration” on page 44.7](#), [“Dynamic Rendezvous Point configuration” on page 44.9](#) and [“Bootstrap Router configuration” on page 44.11](#).

ping

Ping tests the connectivity between two network devices to determine whether each network device can “see” the other device.

ping-of-death attack

A type of attack on a computer that involves sending a malformed or otherwise malicious ping to a network device.

ping polling

Ping polling is used to ensure that a device is still present, live, and contactable in the network by periodically sending a packet to an IP address and waiting for a response. Configurable actions can be performed if responses are no longer arriving.

For more information see [Chapter 88, Ping Polling Introduction](#). For how to configure ping polling see [“Configuring Ping Polling” on page 88.4](#).

policing

In [QoS](#), once you have set-up your [classification](#) and created your [class maps](#), you can start conditioning your traffic flows. One tool used for traffic conditioning is the policer (or meter). The principle of policing is to measure the data flow that matches the definitions for a particular class-map; then, by selecting appropriate data rates, allocate the flows into one of three categories, Red Yellow or Green. You then decide what action to apply to the Red, Yellow and Green data. See [premarking](#).

For more information see [“Policing \(Metering\) Your Data” on page 52.16](#).

policy maps

Policy maps are the means by which you apply your [class maps](#) to physical switch ports. A policy map can be assigned to several ports, but a port cannot have more than one policy map assigned to it. See [QoS](#).

For more information see [“Policy Maps” on page 52.10](#).

port bit map

An efficient method for the storage of a list of ports. Each port is represented by a single bit in a 32-bit or 64-bit value.

port mirroring

Port mirroring enables traffic being received and transmitted on a switch port to be sent to another switch port, the mirror port, usually for the purposes of capturing the data with a protocol analyzer. The mirror port is the only switch port that does not belong to a VLAN, and therefore does not participate in any other switching. Before the mirror port can be set, it must be removed from all trunk groups and all VLANs except the default VLAN.

PPP

Point-to-Point Protocol. A data link protocol used to establish a direct connection between two networking nodes. PPP can provide connection authentication and transmission encryption. PPPoE (Point-to-Point Protocol over Ethernet) is used over broadband connections as is PPPoA (Point-to-Point Protocol over ATM) with DSL.

premarking

In [QoS](#), premarking relates to adding QoS markers to your incoming data traffic before it is metered. QoS markers can be applied at both the link layer (within the CoS field), and at the network layer (within the DSCP field). See [policing](#).

For more information see [“Premarking your Traffic” on page 52.11](#).

primary port

In [EPSR](#), a ring port on the master node. This port determines the direction of the traffic flow, and is always operational.

For more information see [“Ring Components and Operation” on page 71.2](#).

provisioning

Stack member provisioning is the pre-configuration of [stack member](#) position ready for insertion at a later time. Provisioning enables a network administrator to pre-configure vacant stack member capacity within a [VCStack](#), ready to be hot-swapped in at a later time. Later, when the stack member switch is physically added, its configuration is automatically applied with the minimum network disruption.

For more information see [“Provisioning \(Stack Members\)” on page 92.18](#).

proxy ARP

Proxy ARP allows hosts that do not support routing (i.e. they have no knowledge of the network structure) to determine the physical addresses of hosts on other networks.

For more information see [“Proxy ARP” on page 22.4](#).

PSU

Power Supply Unit.

Q

Query Solicitation

Query Solicitation minimizes the loss of multicast data after a topology change on networks that use [EPSR](#) or spanning tree ([STP](#), [RSTP](#), or [MSTP](#)) for loop protection. Without Query Solicitation, when the underlying link layer topology changes, multicast data flow can stop for up to several minutes, depending on which port goes down and how much of the IGMP query interval remained at the time of the topology change. Query Solicitation greatly reduces this disruption.

For more information see [“Introduction to Query Solicitation” on page 41.4.](#)

QoS

Quality of Service. QoS enables you to both prioritize traffic and limit its available bandwidth. The concept of QoS is a departure from the original networking protocols, in which all traffic on the Internet or within a LAN had the same available bandwidth. Without QoS, all traffic types are equally likely to be dropped if a link becomes oversubscribed. This approach is now inadequate in many networks, because traffic levels have increased and networks often carry time-critical applications such as streams of real-time video data. QoS also enables service providers to easily supply different customers with different amounts of bandwidth. Configuring Quality of Service involves two separate stages:

- Classifying traffic into flows, according to a wide range of criteria. Classification is performed by the switch's [class maps](#).
- Acting on these traffic flows.

For more information see [Chapter 52, Quality of Service \(QoS\).](#)

Quality of Service

See [QoS](#).

R

RADIUS

Remote Authentication Dial-In User Service. RADIUS is a networking protocol that provides centralized [AAA](#) (Authentication Authorization and Accounting) management for clients to a network. RADIUS is a client/server protocol that runs in the application layer, using UDP (User Datagram Protocol) for data transport. RADIUS authenticates users before granting them access to network resources and can account for the usage of network resources.

For more information see [Chapter 60, RADIUS Introduction and Configuration.](#) For configuration examples see [“RADIUS Configuration Examples” on page 60.13.](#)

redistribute

Advertise routes learnt from one routing protocol into another routing protocol.

Remote Network MONitoring

See [RMON](#).

resiliency link

In [VCStack](#), an extra, out-of-band, data link between stack members. In the event of loss of communication across the stacking connection, the stack members can determine the status of other members via communication on the resiliency link. This assists the stack members in deciding the correct course of action when communication on the stack is lost.

For more information see [“Stack Resiliency Link” on page 92.14](#).

RIB

Routing Information Base. The RIB records all the routes that your device has learnt. Your device uses the RIB to advertise routes to its neighbor devices and to populate the [FIB](#) (Forwarding Information Base).

For more information see [“RIB and FIB Routing Tables” on page 29.4](#).

ring port

In [EPSR](#), a port that connects the node to the ring. On the master node, each ring port is either the primary port or the secondary port. On transit nodes, ring ports do not have roles.

For more information see [“Ring Components and Operation” on page 71.2](#).

RIP

Routing Information Protocol. A simple distance vector IPv4 routing protocol, RIP is an Interior Gateway Protocol (IGP) that uses hop counts as its metrics. Given a choice of routes, RIP uses the route that takes the lowest number of hops. If multiple routes have the same hop count, RIP chooses the first route it finds. The AlliedWare Plus™ RIP module supports RFCs 1058 and 1723; the RIPv2 module supports more fields in the RIP packets, and supports security authentication features.

For more information see [“RIP” on page 28.2](#). For configuration examples see [“Enabling RIP” on page 31.2](#), [“Specifying the RIP Version” on page 31.4](#), [“RIPv2 Authentication \(Single Key\)” on page 31.6](#), [“RIPv2 Text Authentication \(Multiple Keys\)” on page 31.8](#) and [“RIPv2 md5 authentication \(multiple keys\)” on page 31.12](#).

RIPng

Routing Information Protocol next generation. RIPng is a simple distance vector IPv6 routing protocol. It determines the number of hops between the destination and your device, where one hop is one link. Given a choice of routes, RIPng uses the route that takes the lowest number of hops. If multiple routes have the same hop count, RIPng chooses the first route it finds. RIPng is an extension of RIPv2 to support IPv6.

For configuration examples see [“Enabling RIPng” on page 33.2](#) and [“Troubleshooting RIPng Adjacency” on page 33.4](#).

RIPv6

See [RIPng](#).

RMON

Remote Network MONitoring. RMON was developed by the IETF to support monitoring and protocol analysis of LANs with a focus on Layer 1 and 2 information in networks. RMON is an industry standard that provides the functionality in network analyzers. An RMON implementation operates in a client/server model. Monitoring devices (or 'probes') contain RMON agents that collect information and analyze packets. The probes are servers and the Network Management applications that communicate with them are clients.

For more information see [Chapter 83, RMON Introduction](#). For a configuration example see ["RMON Configuration Example" on page 83.3](#).

Roaming Authentication

Roaming Authentication improves the usability of network security by enabling users to move within the network without requiring them to re-authenticate each time they move. If a supplicant (client device) moves from one wireless access point to another wireless access point, and the wireless access points are connected to different ports, then the switch (authenticator) recognizes that the supplicant has been authenticated and accepts the supplicant without requiring re-authentication.

For more information see ["Roaming Authentication" on page 56.4](#).

root bridge

A single [bridge](#) is selected to become the [spanning tree's](#) unique root bridge. This is the device that advertises the lowest Bridge ID. Each bridge is uniquely identified by its Bridge ID, which comprises the bridge's root priority (a spanning tree parameter) followed by its MAC address.

For an overview of spanning tree operation see ["Spanning tree operation" on page 18.2](#).

root path cost

A [spanning tree](#) property. Each port connecting a [bridge](#) to a LAN has an associated cost, called the root path cost. This is the sum of the costs for each path between the particular bridge port and the [root bridge](#). The [designated bridge](#) for a LAN is the one that advertises the lowest root path cost. If two bridges on the same LAN have the same lowest root path cost, then the switch with the lowest bridge ID becomes the designated bridge.

For an overview of spanning tree operation see ["Spanning tree operation" on page 18.2](#).

route-map

A mechanism for filtering IP routes and changing their attributes.

RSTP

Rapid Spanning Tree Protocol. RSTP is an evolution of the Spanning Tree Protocol ([STP](#)) which provides for faster spanning tree convergence after a topology change. A device running RSTP is compatible with other devices running STP.

For more information see ["Rapid Spanning Tree Protocol \(RSTP\)" on page 18.7](#). For a configuration example see ["Configuring RSTP" on page 18.8](#).

S

SCP

Secure Copy Protocol. SCP allows for secure file transfer to and from the switch, protecting your network from unwanted downloads and unauthorized file copying.

For more information see [“Copying with Secure Copy \(SCP\)” on page 6.14.](#)

script

A script is a sequence of commands stored as a plaintext file on a file subsystem accessible to the device, such as Flash memory. Each [trigger](#) may reference multiple scripts and any script may be used by any trigger. When an event activates a trigger, the trigger executes the scripts associated with it in sequence. One script is executed completely before the next script begins.

See [Dynamic Link Failover](#).

secondary port

In [EPSR](#), a second ring port on the master node. This port remains active, but blocks all protected VLANs from operating unless the ring fails. Similar to the blocking port in an STP/RSTP instance.

For more information see [“Ring Components and Operation” on page 71.2.](#)

sFlow

sFlow^{®1} is an industry standard technology for monitoring high speed switched networks. It provides the ability to monitor traffic in data networks containing switches and routers.

1. sFlow[®] is a registered trademark belonging to InMon Corp, San Francisco, CA.

For more information see [Chapter 90, sFlow Introduction](#). For how to configure sFlow see [“Configuring sFlow on your Switch” on page 90.6.](#)

sFlow agent

A network employing sFlow typically comprises a number of network (sFlow) agents that accumulate sampled data and traffic counter information. The agents then forward this data to a collector. The collector then analyses the information supplied by its agents in order to compile and display statistical profiles of the network and its traffic. The sFlow feature on your switch provides the sFlow agent capability.

For more information see [“The sFlow Agent” on page 90.3.](#)

sFlow collector

The sFlow collector receives traffic samples and counter information from a number of sFlow agents. These samples are received as a series of UDP datagrams. From the data contained within these datagrams, the collector is able to provide statistical and or graphical information of network traffic.

For more information see [“The sFlow Collector” on page 90.5.](#)

SFTP

SSH File Transfer Protocol. SFTP provides a secure way to copy files onto your device from a remote device.

For more information see [“Copying with SSH File Transfer Protocol \(SFTP\)”](#) on page 6.14.

software ACLs

See [ACL types](#).

spanning tree

A loop free portion of a network topology. The network topology is dynamically pruned to provide only one path for any packet. See [STP](#), [RSTP](#) and [MSTP](#).

Spanning Tree Protocol Root Guard

See [STP Root Guard](#).

SSH

Secure Shell. SSH is a network protocol that uses strong authentication and encryption for remote access across a nonsecure network. SSH provides sessions between a host running a SSH server and a machine with a SSH client.

For more information see [Chapter 64, Secure Shell \(SSH\) Introduction](#). For how to configure a SSH server see [“Configuring the SSH Server”](#) on page 64.4. For how to configure a SSH client see [“Configuring the SSH Client”](#) on page 64.9.

stack

See [VCStack](#).

stack master

The switch that manages the stack, or [VCStack](#), also referred to as the active master.

stack member

An individual switch that is part of a [VCStack](#).

S-TAG

Service VLAN TAG.

static aggregator

See [static channel group](#).

static channel group

A static channel group, also known as a static aggregator, enables a number of ports to be manually configured to form a single logical connection of higher bandwidth. By using static channel groups you increase channel reliability by distributing the data path over more than one physical link.

storm-control

Storm-control enables you to specify the threshold level for broadcasting, multicast, or destination lookup failure (DLF) traffic for a port. Storm-control limits the specified traffic type to the specified threshold.

For more information see [“Storm-control” on page 14.19](#).

storm protection

Storm protection uses [QoS](#) mechanisms to classify on traffic likely to cause a packet storm (broadcast and multicast). With QoS storm protection, several actions are possible when a storm is detected:

- You can disable the port physically.
- You can disable the port logically.
- You can disable the port for a particular VLAN.

For more information see [“Storm Protection” on page 52.34](#).

STP

Spanning Tree Protocol. STP is the original bridge protocol defined by IEEE standard 802.1D-1988. It creates a single spanning tree over a network.

For more information see [“Spanning Tree Protocol \(STP\)” on page 18.5](#). For a configuration example see [“Configuring STP” on page 18.6](#).

STP Root Guard

Spanning Tree Protocol Root Guard. STP Root Guard designates which devices can assume the role of [root bridge](#) in an STP network. This stops an undesirable device from taking over this role, where it could either compromise network performance or cause a security weakness.

See the [spanning-tree guard root command on page 19.33](#). For configuration examples see (STP) [“Configure Root Guard” on page 18.6](#), (RSTP) [“Configure Root Guard” on page 18.8](#) and (MSTP) [“Configure Root Guard” on page 18.19](#).

subnet address

A subnet portion of an IP address. In a subnetted network, the host portion of an IP address is split into a subnet portion and a host portion using an address or subnet mask.

subnet mask

A bit mask used to select bits from an Internet address for subnet addressing. The mask is 32 bits long and selects the network portion of the Internet address and one or more bits of the local portion. Sometimes called address mask.

switch instance

A single switch chip with its associated ports, internal data interfaces, hardware tables, and packet buffer memory.

S-VID

Service VLAN ID.

S-VLAN

Service VLAN.

T

thrash limiting

MAC address thrashing occurs when MAC addresses move rapidly between one or more ports or trunks, for example, due to a network loop. Thrash limiting enables you to apply actions to a port when thrashing is detected. It is supported on all port types and also on aggregated ports.

For more information see [“Thrash Limiting” on page 14.21](#)

TLV

Type-Length-Value. A single [LLDPDU](#) contains multiple TLVs. TLVs are short information elements that communicate complex data, such as variable length strings, in a standardized format. Each TLV advertises a single type of information, such as its device ID, type, or management addresses. See [LLDP advertisements](#).

traceroute

Traceroute is used to discover the route that packets pass between two systems running the IP protocol. Traceroute sends an initial UDP packets with the Time To Live (TTL) field in the IP header set starting at 1. The TTL field is increased by one for every subsequent packet sent until the destination is reached. Each hop along the path between two systems responds with a TTL exceeded packet (ICMP type 11) and from this the path is determined.

transit node

In [EPSR](#), nodes other than the master node in the domain.

Transit node states are:

- Idle - the state when [EPSR](#) is first configured, before the master node determines that all links in the ring are up. In this state, both ports on the node are blocked for the data VLAN. From this state, the node can move to Links Up or Links Down.
- Links Up - the state when both the node's ring ports are up and forwarding. From this state, the node can move to Links Down.
- Links Down - the state when one or both of the node's ring ports are down. From this state, the node can move to Preforwarding.
- Pre-forwarding - the state when both ring ports are up, but one has only just come up and is still blocked to prevent loops. From this state, the transit node can move to Links Up if the master node blocks its secondary port, or to Links Down if another port goes down.

For more information see [“Ring Components and Operation” on page 71.2](#).

tri-authentication

Authentication commands enable you to specify three different types of device authentication: [802.1X authentication](#), [MAC authentication](#), and [Web-authentication](#). All three types can be configured to run simultaneously on a switch port. The simultaneous configuration and authentication of all three types on a port is called tri-authentication.

For a configuration example see [“Tri-Authentication Configuration” on page 56.2](#).

trigger

A trigger is an ordered sequence of scripts that is executed when a certain event occurs. Each trigger may reference multiple scripts and any [script](#) may be used by any trigger. When an event activates a trigger, the trigger executes the scripts associated with it in sequence. One script is executed completely before the next script begins.

See [Dynamic Link Failover](#).

Type-Length-Value

See [TLV](#).

U

unicast

Two individual devices hold a conversation just between themselves.

V

VCStack

A group of two or more switches operating as a single switch. See [Virtual Chassis Stacking](#).

VCStack Fast Failover

VCStack Fast Failover provides absolutely minimal network downtime in the event of a problem with the stack.

See the [reboot rolling command on page 93.6](#).

VID

VLAN Identifier or VLAN ID. When you create a VLAN you give it a numerical VID which is included in VLAN-tagged Ethernet frames to and from this VLAN.

Virtual Chassis Stacking

Virtual Chassis Stacking (VCStack™) is the name given to two or more Allied Telesis switches that are configured to operate as a single switch. From a configuration and management point of view, it is as though the switches are just one device with a seamless transition from the ports of one stack member to the ports of the next.

For more information see [Chapter 92, Stacking Introduction](#).

VLAN classification

A packet can be allocated VLAN membership based on its protocol, subnet, or port.

VLAN double tagging

VLAN double tagging is used to overlay a private Layer 2 network over a public Layer 2 network. A VLAN double tagging implementation consists of the following port types:

- Provider ports - these connect to a service provider's Layer-2 network.
- Customer edge ports - these connect to a customer's private Layer-2 network.

For more information see [“VLAN Double Tagging \(VLAN Stacking\)” on page 16.5](#). For a configuration example see [“Configuring Double-Tagged VLANs” on page 16.6](#).

VLAN ID

See [VID](#).

VLAN Identifier

See [VID](#).

VLAN stacking

See [VLAN double tagging](#).

VLAN tag

A 32-bit field inside an Ethernet frame that identifies which VLAN a packet is forwarded to. The tag can, optionally, also contain an indicator of what priority to give the packet at times of congestion.

Voice VLAN

Voice VLAN automatically separates voice and data traffic into two different VLANs. This automatic separation places delay-sensitive traffic into a voice-dedicated VLAN, which simplifies QoS configurations.

For more information see [“Voice VLAN” on page 80.4](#).

VoIP

Voice over Internet Protocol. Enables the delivery of voice communications over IP networks such as the Internet or other packet-switched networks instead of over traditional telephony circuits.

VRID

Virtual Router Identifier.

VRRP

Virtual Router Redundancy Protocol. VRRP combines two or more physical switches into a logical grouping called a virtual router. The physical switches then operate together to provide a single logical gateway for hosts on the LAN. If the master fails, the other devices assume the virtual IP address.

For more information see [Chapter 69, VRRP Introduction](#). For configuration examples see [“Configuration Examples” on page 69.9](#).

W

Web-authentication

The switch sends a login screen to the client webbrowser which must be authenticated before access is granted to the network. See [AAA](#) and [tri-authentication](#).

For a sample configuration script see [“Sample Web-Authentication Configuration” on page 58.8](#).

wildcard mask

A subnet mask in which bits set to 0 indicate an exact match and bits set to 1 indicate 'don't care'.

X

XEM

High Speed Expansion Module.

Y

Z

