

# IE048-240

Industrial AC/DC Power Supply

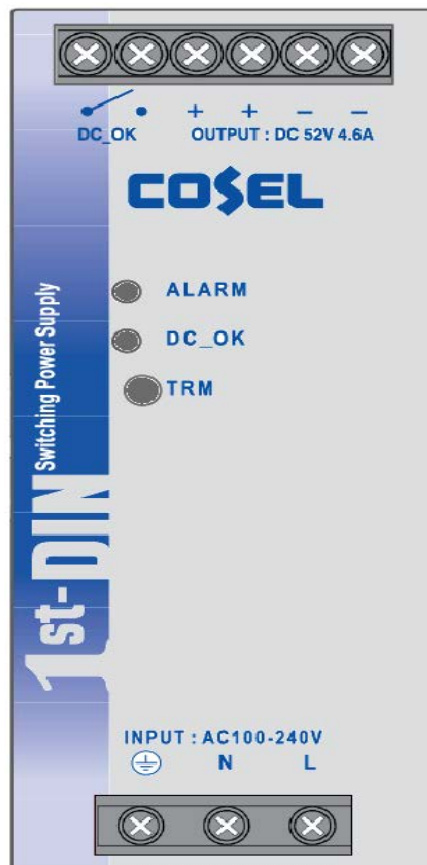

## Installation Guide

Copyright © 2024 Allied Telesis, Inc.

All rights reserved. No part of this publication may be reproduced without prior written permission from Allied Telesis, Inc.

Allied Telesis and the Allied Telesis logo are trademarks of Allied Telesis, Incorporated. All other product names, company names, logos or other designations mentioned herein are trademarks or registered trademarks of their respective owners.

Allied Telesis, Inc. reserves the right to make changes in specifications and other information contained in this document without prior written notice. The information provided herein is subject to change without notice. In no event shall Allied Telesis, Inc. be liable for any incidental, special, indirect, or consequential damages whatsoever, including but not limited to lost profits, arising out of or related to this manual or the information contained herein, even if Allied Telesis, Inc. has been advised of, known, or should have known, the possibility of such damages.

# Electrical Safety and Emissions Standards

---

This section contains the following:

- ❑ “US Federal Communications Commission”
- ❑ “Industry Canada” on page 4
- ❑ “VCCI Statement” on page 4
- ❑ “Regulatory Approvals” on page 4

## US Federal Communications Commission

---

### Radiated Energy

---

**Note**

This equipment has been tested and found to comply with the limits for a Class A digital device pursuant to Part 15 of FCC Rules. These limits are designed to provide reasonable protection against harmful interference when the equipment is operated in a commercial environment. This equipment generates, uses, and can radiate radio frequency energy and, if not installed and used in accordance with this instruction manual, may cause harmful interference to radio communications. Operation of this equipment in a residential area is likely to cause harmful interference in which case the user will be required to correct the interference at his own expense.

---

---

**Note**

Modifications or changes not expressly approved of by the manufacturer or the FCC, can void your right to operate this equipment.

---

# Industry Canada

---

## Radiated Energy

This Class A digital apparatus complies with Canadian ICES-003.

Cet appareil numérique de la classe A est conforme à la norme NMB-003 du Canada.

## VCCI Statement

---

この装置は、クラスA情報処理装置です。この装置を家庭環境で使用すると電波妨害を引き起こすことがあります。この場合には使用者が適切な対策を講ずるよう要求されることがあります。VCCI-A

## Regulatory Approvals

---

### Compliance Marks

CE, cULus, RCM, UL (Demko)

### Environmental Compliance

RoHS, China-RoHS, WEEE

### Safety

CAN/CSA C22.2 No.107.1-01

CAN/CSA C22.2 No.60950-1

EN/IEC/UL 60950-1

UL 508

### Electromagnetic Immunity

EN 55024

IEC 61000-3-2

IEC 61000-4-2 level 4

IEC 61000-4-3 Level 3

IEC 61000-4-4 Level 4

IEC 61000-4-5 level 3 (L-L), level 4 (L-E)

IEC 61000-4-6 Level 3

IEC 61000-4-8 Level 4

IEC 61000-4-11

### Electromagnetic Emissions

CISPR 32, class B

EN 55011, class B

EN 55032, class B

FCC47 CFR Part 15, subpart B, class B

VCCI class B

**Shock**

Non-operating: 20g 11ms, half-sine (packaged)

**Vibration**

Non-operating: 2g @10-55Hz (DIN Rail)

**Hazardous Location**

ANSI/ISA-12.12.01 Class 1, division 2, Groups A, B, C, and D

**Operating Temperature Range**

-25° to 70°C



# Contents

---

<b>Preface</b> .....	<b>13</b>
Safety Symbols Used in this Document .....	14
Translated Safety Statements .....	15
<b>Chapter 1: Overview</b> .....	<b>17</b>
Features .....	18
Hardware Components .....	19
AC/DC Input Connectors .....	22
Input Power Connectors .....	22
Input Power Ranges .....	22
Wiring Specifications .....	22
DC Output Connectors .....	23
TRM Screw for Adjusting the Output DC Voltage .....	24
Remote Control Connector for Turning On or Off the DC Output Connectors .....	25
Power Alert DC_OK Connector .....	27
LEDs .....	28
DIN Rail Installation .....	29
Network Devices .....	30
<b>Chapter 2: Beginning the Installation</b> .....	<b>31</b>
Reviewing Safety Precautions .....	32
Safety Precautions When Working with Electricity .....	35
Reviewing Site Requirements .....	36
General Site Requirements .....	36
Indoor or Outdoor Enclosure Requirements .....	36
Grounding Requirements .....	37
Lightning Protection Requirements .....	38
Installation Worksheets .....	39
<b>Chapter 3: Installing the Power Supply</b> .....	<b>43</b>
Reviewing Power Supply Orientation .....	44
Reviewing Power and Control Wires Guidelines .....	46
Installing the Power Supply on a DIN Rail .....	48
Connecting the Ground Wire .....	50
Connecting the AC or DC Power Wires .....	52
Adjusting the Voltage on the DC Output Connectors .....	54
Wiring the DC Output Connectors to Powered Devices .....	55
Wiring the Remote Control (RC) Connector .....	57
Wiring the Power Alert DC_OK Connector .....	58
Verifying the Power Supply .....	59
<b>Chapter 4: Troubleshooting</b> .....	<b>61</b>
<b>Appendix A: Technical Specifications</b> .....	<b>65</b>
Physical Specifications .....	66
Power Specifications .....	67
Environmental Specifications .....	69
Derating Graphs - Operating Properties and Ambient Temperature .....	70
Device Dimensions .....	72





# Figures

---

Figure 1: Front Panel .....	19
Figure 2: Top Panel .....	20
Figure 3: Bottom Panel .....	21
Figure 4: DIN Rail .....	29
Figure 5: Vertical Installation .....	44
Figure 6: Unsupported DIN Rail Installations .....	44
Figure 7: Unsupported Table, Desk, or Shelf Installation .....	45
Figure 8: Minimum Spacing Requirements .....	45
Figure 9: Wrapping Wire Strands .....	47
Figure 10: Verifying Wire Installation .....	47
Figure 11: Installing the Power Supply on a DIN Rail .....	48
Figure 12: Installing the Ground Wire .....	50
Figure 13: Installing the AC or DC Power Wires .....	53
Figure 14: Installing DC Output Power Wires .....	56
Figure 15: Wiring the RC Connector .....	57
Figure 16: Wiring the DC_OK Connector .....	58
Figure 17: Derating Graph at 100Vac .....	70
Figure 18: Derating Graph at 230Vac .....	71
Figure 19: Derating Graph at Input Voltage .....	71
Figure 20: IE048-240 Power Supply Dimensions .....	72



# Tables

---

Table 1: Wire Specifications for the N and L Input Connectors .....22

Table 2: Wire Specifications for the DC Output Connectors .....23

Table 3: Specifications of the Remote Control Circuit .....25

Table 4: Wire Specifications for the Remote Control Connector .....26

Table 5: Wire Specifications for the DC\_OK Connectors .....27

Table 6: Status LEDs .....28

Table 7: Ground Resistivity Recommendations .....38

Table 8: Installation Worksheet 1: IE048-240 AC/DC Power Supply .....40

Table 9: Installation Worksheet 2: Powered Devices .....41

Table 10: Wire Specifications .....46

Table 11: Product Dimensions (W x D x H) .....66

Table 12: Product Weight .....66

Table 13: Ventilation Requirements .....66

Table 14: Minimum Cabinet (Enclosure) Dimensions .....66

Table 15: Input Power Specifications .....67

Table 16: Output Power Specifications .....67

Table 17: Environmental Specifications .....69



# Preface

---

This guide contains the hardware installation instructions for the IE048-240 Industrial AC/DC Power Supply. The preface contains the following sections:

- “Safety Symbols Used in this Document” on page 14
- “Translated Safety Statements” on page 15

---

**Note**

For assistance with this product, visit the Allied Telesis web site at [www.alliedtelesis.com](http://www.alliedtelesis.com).

---

## Safety Symbols Used in this Document

---

This document uses the following conventions.

---

**Note**

Notes provide additional information.

---



---

**Caution**

Cautions inform you that performing or omitting a specific action may result in equipment damage or loss of data.

---



---

**Warning**

Warnings inform you that performing or omitting a specific action may result in bodily injury.

---



---

**Warning**

Warnings inform you of hot surfaces.

---

## Translated Safety Statements

---

**Important:** The  indicates that translations of the safety statement are available in the PDF document **Translated Safety Statements** posted on the Allied Telesis website at [alliedtelesis.com/library/search](http://alliedtelesis.com/library/search).

- Übersetzte Sicherheitserklärungen

**Wichtig:** Das  zeigt an, dass Übersetzungen der Sicherheitserklärung in den PDF-**Translated Safety Statements** auf der Allied Telesis-Website unter [alliedtelesis.com/us/en/library/search](http://alliedtelesis.com/us/en/library/search) verfügbar sind.

- Declaraciones de seguridad traducidas

**Importante:** El  indica que las traducciones de la declaración de seguridad están disponibles en las **Translated Safety Statements** en PDF publicadas en el sitio web de Allied Telesis en [alliedtelesis.com/us/en/library/search](http://alliedtelesis.com/us/en/library/search).

- Consignes de sécurité traduites

**Important:** Le symbole  indique que les traductions de la déclaration de sécurité sont disponibles dans le PDF **Translated Safety Statements** publiées sur le site Web de Allied Telesis à l'adresse [alliedtelesis.com/us/en/library/search](http://alliedtelesis.com/us/en/library/search).

- Dichiarazioni di sicurezza tradotte

**Importante:**  indica che le traduzioni della dichiarazione di sicurezza sono disponibili nelle **Translated Safety Statements** in PDF pubblicate sul sito Web di Allied Telesis all'indirizzo [alliedtelesis.com/us/en/library/search](http://alliedtelesis.com/us/en/library/search).

- Översatta säkerhetsförklaringar

**Viktig:**  anger att översättningar av säkerhetsförklaringen finns tillgängliga i PDF-dokumentet **Translated Safety Statements** som publicerats på Allied Telesis webbplats på [alliedtelesis.com/us/en/library/search](http://alliedtelesis.com/us/en/library/search).





## Chapter 1

# Overview

---

This chapter describes the hardware features of the IE048-240 Power Supply. The sections in the chapter are listed here:

- ❑ “Features” on page 18
- ❑ “Hardware Components” on page 19
- ❑ “AC/DC Input Connectors” on page 22
- ❑ “DC Output Connectors” on page 23
- ❑ “TRM Screw for Adjusting the Output DC Voltage” on page 24
- ❑ “Remote Control Connector for Turning On or Off the DC Output Connectors” on page 25
- ❑ “Power Alert DC\_OK Connector” on page 27
- ❑ “LEDs” on page 28
- ❑ “DIN Rail Installation” on page 29
- ❑ “Network Devices” on page 30

## Features

---

The IE048-240 Power Supply is a DC power supply for industrial equipment from Allied Telesis. The input power to the IE048-240 Power Supply can be either AC or DC. The unit features a stainless steel enclosure that makes it suitable for harsh environments and a pre-installed DIN rail bracket for installation on standard 35x7.5mm and 35x15mm DIN rails. Main features of the product include:

- ❑ Maximum 240W DC output
- ❑ AC input range of 100Vac to 240Vac
- ❑ Maximum AC input range of 90Vac to 264Vac
- ❑ Maximum DC input range of 88Vdc to 350Vdc
- ❑ Adjustable DC output range of 45.0Vdc to 55.2Vdc
- ❑ Default 48Vdc output
- ❑ Remote Control (RC) circuit for remotely turning the DC output connectors on and off
- ❑ Alarm circuit (DC\_OK) for output power alerts
- ❑ LEDs for the Remote Control and DC\_OK circuits
- ❑ DIN bracket installation
- ❑ Industrial case for harsh environments (IP20)
- ❑ Operating temperature range of -25°C to 70°C
- ❑ Electromagnetic immunity (EMI) suitable for industrial applications
- ❑ High efficiency: 94% @230Vac
- ❑ 150% peak current capability
- ❑ Active PFC: PF type 0.93 @230Vac
- ❑ Protection circuits: peak-current, over-current, over-voltage, over-temperature



### Caution

The DC output power of the IE048-240 Power Supply is affected by the AC or DC input voltage and ambient temperature. Refer to “Derating Graphs - Operating Properties and Ambient Temperature” on page 70 for the derating curves.

---

### Note

The power supply does not support parallel, backup, or redundancy operation.

---

## Hardware Components

Figure 1 identifies the hardware components on the front panel.

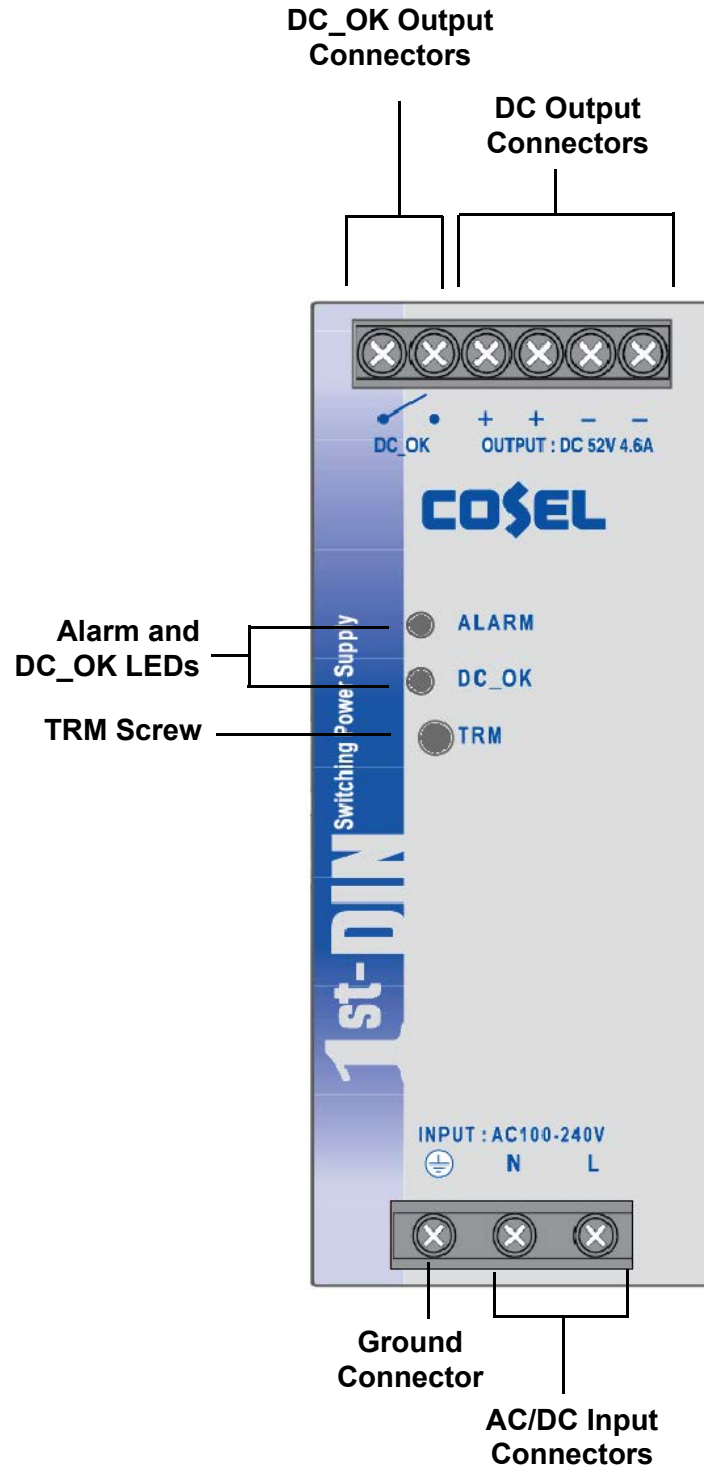

Figure 1. Front Panel

The hardware components on the top panel are shown in Figure 2.

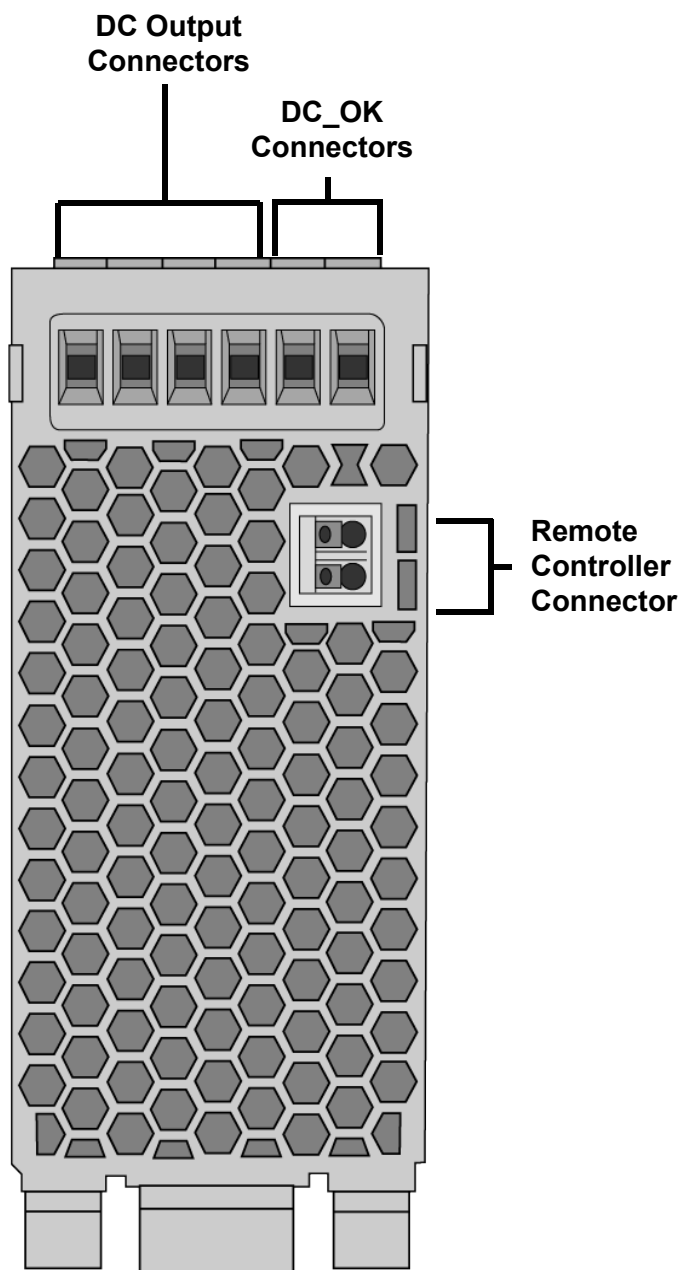

Figure 2. Top Panel

The bottom panel is shown in Figure 3.

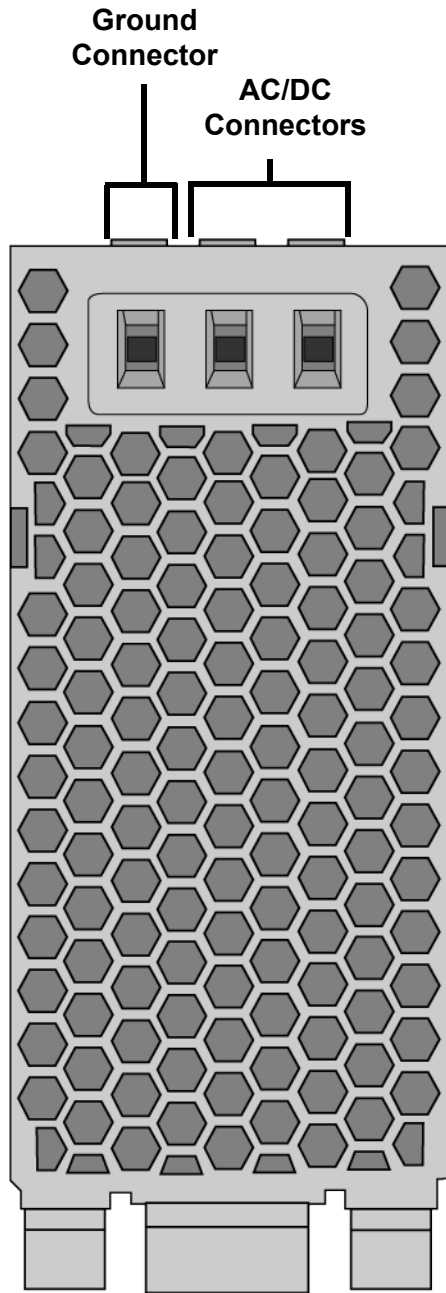

Figure 3. Bottom Panel

## AC/DC Input Connectors

---

The input power of the IE048-240 Power Supply can be either AC or DC.

### Input Power Connectors

The unit is connected to the AC or DC power source with the N (Neutral) and L (Live) connectors on the front panel.

---

#### Note

To power the unit with a DC power source, connect the Positive (+) wire to the L (Live) connector and the Negative (-) wire to the N (Neutral) connector.

---

### Input Power Ranges

The AC and DC input power ranges are:

- ❑ 90Vac to 264Vac
- ❑ 88Vdc to 350Vdc

### Wiring Specifications

Table 1 lists the wire specifications for the L (Live) and N (Neutral) input connectors. The specifications are the same both AC and DC input wires.

Table 1. Wire Specifications for the N and L Input Connectors

Wire	Description
Solid Wire	AWG 20 to AWG 10 (Diameter 0.8 to 2.6mm)
Stranded Wire	AWG 20 to AWG 10 (Diameter 0.5 to 5.2mm; conductor diameter more than 0.18mm)
Insulation Strip Length	8mm



#### Warning

Never handle live AC or DC power wires. Always verify that the AC or DC circuit is powered off before connecting or disconnecting power wires from the circuit breaker or power supply.

---

## DC Output Connectors

---

The power supply has four DC output connectors on the front panel, two positive (+) and two negative (-). Here are the guidelines:

- ❑ You can use either of the positive connectors with either of the negative connectors. (The positive connectors are connected internally in the power supply as are the two negative connectors.)
- ❑ You can adjust the DC output of the connectors with the TRM screw on the front panel. The range is 48.0Vdc to 55.0Vdc. The default is 52.0Vdc. Refer to “TRM Screw for Adjusting the Output DC Voltage” on page 24.
- ❑ Allied Telesis recommends testing the output voltages on the output connectors with a voltmeter and adjusting the output voltage with the TRM screw, if necessary, before connecting powered devices to the power supply. Testing ensures that the power supply provides the correct DC voltage to the devices.
- ❑ You can remotely turn on and off the DC output connectors using the Remote Control circuit. Refer to “Remote Control Connector for Turning On or Off the DC Output Connectors” on page 25.

The wire specifications for the DC output connectors are listed in Table 2.

Table 2. Wire Specifications for the DC Output Connectors

Wire	Description
Solid Wire	AWG 20 to AWG 10 (Diameter 0.8 to 2.6mm)
Stranded Wire	AWG 20 to AWG 10 (Diameter 0.5 to 5.2mm; Conductor diameter more than 0.18mm)
Insulation Strip Length	8mm

## **TRM Screw for Adjusting the Output DC Voltage**

---

The DC output connectors on the power supply have a power range of 48.0Vdc to 55.0Vdc. The default is 52.0Vdc. You can adjust the output voltage with the TRM screw on the front panel. Here are the guidelines:

- ❑ A voltmeter is required to adjust the DC output power.
- ❑ You should verify and adjust output power before connecting powered devices to the power supply.
- ❑ The TRM screw configures the voltages on both sets of DC output connectors together. You cannot set the connectors separately.
- ❑ Refer to the powered device's installation guide for input power requirements.



## Remote Control Connector for Turning On or Off the DC Output Connectors

---

On top of the power supply are Remote Control (RC) connectors. You may use the connectors to remotely turn on or off the DC output connectors, and so remotely power off the devices that are connected to the power supply. You might use this feature when the devices are experiencing technical problems or under network attack, or if the power supply itself is experiencing a problem. Once a network problem is resolved, you can use the Remote Control connector to remotely power on the DC output connectors and devices again.



### Warning

Depending on the types of devices connected to the power supply, powering off the DC output connectors may disrupt network operations. *E131*

---

Here are the guidelines to using the RC connector:

- The default setting for the DC output connectors is on.
- All four positive and negative DC output connectors on the power supply are turned on and off together. You cannot control them individually.
- The restart time of the power supply is 750 ms, maximum.
- Using the RC connector is optional.

The specifications for the Remote Control circuit are provided in Table 3.

Table 3. Specifications of the Remote Control Circuit

RC Voltage	Circuit Status	Status of DC Output Connectors
0 to 0.5V (Low level) or open	Open	On (default)
4.5 to 29.5V, 20mA maximum (High level)	Closed	Off

The circuit is an on (open) or off (closed) dry contact relay. The circuit is open when there is no voltage, which turns on the DC output. The circuit default is open. Placing a voltage in the range of 4.5 to 29.5V on the circuit closes it, turning off the DC output connectors.



---

**Caution**

Do not exceed 29.5V on the connector or you may damage it.

*E132*

---

The wire specifications for the Remote Control connector are given in Table 4.

Table 4. Wire Specifications for the Remote Control Connector

<b>Wire</b>	<b>Description</b>
Solid Wire	AWG 24 to AWG 16 (Diameter 0.5 to 1.3mm)
Stranded Wire	AWG 24 to AWG 16 (Diameter 0.2 to 1.5mm)
Insulation Strip Length	8mm

## Power Alert DC\_OK Connector

---

The DC\_OK connector on the front panel can alert you to decreases in the DC output power of the power supply by activating an alert device, such as an LED or buzzer. If the power on the DC output connectors decreases for any reason, the power supply activates the connector and alert device to alert you to the problem.

The circuit is an on (closed) and off (open) dry contact relay. During normal operations the circuit is closed. If the DC output decreases, the power supply opens the circuit. It remains open until DC output power is restored, at which point the power supply automatically closes it again.

The external alert device has to be able to monitor the circuit for when it is closed or open. The circuit supports 20mA maximum.



---

### Caution

Do not exceed 20mA on the connector or you may damage it.

 E132

---

The wire specifications for the DC\_OK connector are given in Table 5.

Table 5. Wire Specifications for the DC\_OK Connectors

Wire	Description
Solid Wire	AWG 24 to AWG 16 (Diameter 0.5 to 1.3mm)
Stranded Wire	AWG 24 to AWG 16 (Diameter 0.2 to 1.5mm)
Insulation Strip Length	8mm

## LEDs

---

The status LEDs are defined in Table 6.

Table 6. Status LEDs

LED	State	Description
ALARM	Off	The power supply is powered off or has shut down.
DC_OK	Off	
ALARM	Off	The power supply is operating normally.
DC_OK	Green	
ALARM	Amber	The output voltage is low compared to the set voltage. Refer to Chapter 4, “Troubleshooting” on page 61.
DC_OK	On or Off	

## DIN Rail Installation

---

The power supply is installed on a DIN rail. The product comes with a standard EN60715 TH 35 DIN rail clip on its back panel for 35x7.5mm and 35x15mm top hat DIN rails.

To install the product on a wall, install a short length of DIN rail on the wall and affix the power supply on the rail. Allied Telesis sells packets of five 35x7.5mm DIN rails for wall installations. Refer to Figure 4 and the Allied Telesis web site for details.

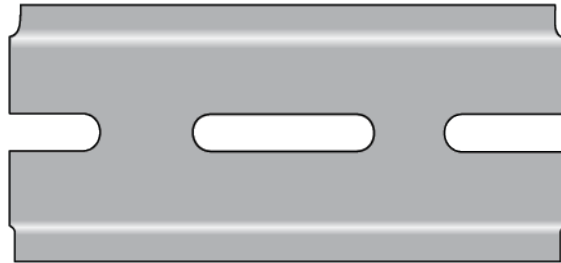

Figure 4. DIN Rail

## Network Devices

---

The power supply supports a variety of products from Allied Telesis, including the IE Series of Industrial Ethernet Switches. For a complete list, refer to the Allied Telesis web site.

The power supply has a maximum DC output power of 240W. The output power can be less, depending on AC or DC input voltage and ambient temperature. Refer to the “Derating Graphs - Operating Properties and Ambient Temperature” on page 70.

The product can support multiple powered devices simultaneously, up to its maximum DC output power. Your installation plans should include determining the power requirements of the individual devices before connecting them to the power supply. Their total power requirements should not exceed the available power of the product.

---

**Note**

The power supply does not alert you if the powered devices exceed its maximum output power.

---

Power devices can be wired directly to the DC Output connectors on the power supply. This is the preferred method when connecting one or two devices. Connecting more than two devices requires a power distribution system, such as DC bus bars. This guide does not explain how to install power distribution systems. Consult with a qualified electrician.

## Chapter 2

# Beginning the Installation

---

The chapter contains the following sections:

- “Reviewing Safety Precautions” on page 32
- “Safety Precautions When Working with Electricity” on page 35
- “Reviewing Site Requirements” on page 36
- “Installation Worksheets” on page 39

## Reviewing Safety Precautions

---

Please review the following safety precautions before beginning the installation procedures.

---

### Note

Safety statements that have the ⚡ symbol are translated into multiple languages in the *Translated Safety Statements* document at [www.alliedtelesis.com/library](http://www.alliedtelesis.com/library).

---



### Caution

The protective features of the product may be impaired if the product is installed or maintained in a manner not approved by Allied Telesis.

---



### Warning

To prevent electric shock, do not remove the cover. No user-serviceable parts inside. This unit contains hazardous voltages and should only be opened by a trained and qualified technician. To avoid the possibility of electric shock, disconnect electric power to the product before connecting or disconnecting the LAN cables.

⚡ E1

---



### Warning

Do not work on equipment or cables during periods of lightning activity. ⚡ E2

---

---

### Note

An appropriate disconnect device must be provided as part of the building or enclosure installation.

---



### Warning

This equipment must be earthed. The ground screw on the unit must be connected to a properly earthed bonding point. ⚡ E120

---



**Warning**

When installing this equipment, always be sure to connect the frame ground wire first. When removing the equipment, always be sure to disconnect the frame ground wire last. ⚡ E11

---

**Warning**

Check to see if there are any exposed copper wires coming from the installed wires. When the installation is done properly, there should be no exposed wire strands extending from the terminal block. Any exposed wiring can conduct harmful levels of electricity to persons touching the wires. ⚡ E12

---

---

**Note**

Ground resistance from the building primary bonding point to earth should be less than 5 ohms.

---

**Caution**

Air flow around the unit and through the cooling fins must not be restricted. ⚠ E20

---

---

**Note**

All Countries: Install product in accordance with local and National Electrical Codes. ⚠ E8

---

**Warning**

Only trained and qualified personnel are allowed to install or replace this equipment. ⚡ E14

---

**Caution**

Circuit Overloading: Consideration should be given to the connection of the equipment to the supply circuit and the effect that overloading of circuits might have on overcurrent protection and supply wiring. Appropriate consideration of equipment nameplate ratings should be used when addressing this concern. ⚠ E21

---



**Caution**

The unit does not contain serviceable components. Please return damaged units for servicing. ⚡ E42

---



**Caution**

An Energy Hazard exists inside this equipment. Do not insert hands or tools into open chassis slots or plugs. ⚡ E44

---



**Warning**

This equipment shall be installed in a Restricted Access location. ⚡ E45

---



**Warning**

To install the device in an outdoor environment, you must use a UL Listed 3X or 4X enclosure. ⚡ E133

---



**Warning**

An operational unit can be hot. Exercise caution when handling with unprotected hands. ⚡ E125

---



**Warning**

Per NEC section 800.90, all exposed cables, service wires, or drops entering a building must have primary over-voltage protection if they are classified as exposed plants. ⚡ E121

---



**Warning**

Never handle live AC power wires. Confirm that the circuit breaker is powered off before attaching the wires to the circuit break or power supply. Always connect the wires to the power supply first and then to the AC circuit breaker. ⚡ E135

---



**Warning**

Do not handle live DC power wires. Connect the wires to the powered device first and then to the power supply. ⚡ E135

---

---

**Note**

Allied Telesis does not warrant against lightning or power surges damaging the device. Such damage will be the responsibility of the equipment owner.

---

## Safety Precautions When Working with Electricity

---

Please review the following additional safety guidelines before beginning the installation procedure.

- Disconnect all power by turning off the circuit breakers before installing or removing the device or when working with the power supplies.
- Do not work alone if potential hazards exist.
- Never assume that the power is disconnected from a circuit; always check the circuit.
- Inspect the work area carefully for possible hazards, such as moist floors, ungrounded power extension cables, frayed power cord, or missing safety grounds.

If an electrical accident occurs, proceed as follows:

- Use caution; do not become a victim yourself.
- Turn off power to the system.
- If possible, send another person to get medical aid. Otherwise, access the condition of the victim and then call for help.
- Determine if the person needs rescue breathing or external cardiac compressions and take appropriate action.

## Reviewing Site Requirements

---

Observe the following requirements when choosing a site for the device:

### General Site Requirements

Listed below are general site requirements:

- You must install the power supply in a restricted access area.
- You must install the power supply on a DIN 35x7.5mm or 35x15mm top hat DIN rail.
- Do not operate the power supply on a table, desk, or shelf.
- The site should allow for easy access to the connectors on the front, top and bottom of the device, so that you can easily connect and disconnect cables, and view the LEDs.
- The power supply should be located near the powered devices to keep the DC power wires as short as possible to minimize voltage loss.
- The site should not expose the device to moisture or water.
- The site should be a dust-free environment.
- Do not place objects on top of the power supply.
- Mounting orientations affect maximum operating temperature capability. Allied Telesis recommends the vertical mounting orientation.
- Electromagnetic interference might occur between switches and other devices when multiple switches are powered by a single DC power supply. This can be addressed by installing clamp-on ferrite beads on the DC power cables, between the DC power supply and switches.
- The site should include dedicated power circuits or power conditioners to supply reliable electrical power to network devices.

### Indoor or Outdoor Enclosure Requirements

The power supply does not require an enclosure for most indoor environments, with the following exceptions:

- The power supply must be installed in a UL-listed or Nationally Recognized Test Lab (NRTL) enclosure when used in Measurement, Control, or Laboratory environments.



#### Warning

The device must be installed in a fire protection enclosure when installed on walls of combustible material (e.g., wood). Additionally, the floor area directly below the power supply should be non-combustible (e.g., metal or concrete) and be free of combustible material (e.g., paper, plastic, or wood). *ES* E134

---

Outdoor installations must observe the following Warning:



### Warning

When installing the device in an outdoor environment, you must use a UL Listed 3X or 4X enclosure. *See* E133

The following are general enclosure requirements:

- Verify that the enclosure has adequate airflow so that unit does not overheat.
- Select an enclosure that is large enough for the switch, power supply, and all other included equipment.
- The enclosure size must be determined by considering multiple factors, including the outside ambient temperature, total heat generated by the installed equipment, sealed or unsealed enclosure type, enclosure material, paint color, mounting method (wall, pole, ground, etc.), and sun load. The smaller enclosure size you choose, the higher the risk of overheating.

If the product overheats in an enclosure that was built without taking into account these factors, the warranty of the product might be voided. Consult Allied Telesis when assistance is needed.

- The enclosure's BTU/hour rating must be higher than the total BTU/hour values of equipment installed in the enclosure, over the expected operating temperature range. For the operating temperature ratings, refer to Table 17 on page 69.
- Be sure to review the enclosure's installation guide for rules and restrictions on site requirements, and to follow all guidelines and safety warnings.
- Outdoor installation requires adequate electromagnetic immunity due to the higher threat-level conditions.

## Grounding Requirements

Here are the requirements for grounding the power supply:

- The power supply and switches must be properly connected to a protective earth ground.
- The power supply and switches must be individually grounded to the grounding conductor. Do not daisy-chain the ground wires.
- If you install the device in a metal enclosure, the enclosure must be properly grounded to a protective earth ground following local electrical codes and the instructions in the manufacturer's installation guide.
- Recommendations for ground resistivity are listed in Table 7 on page 38.

Table 7. Ground Resistivity Recommendations

Level	Recommendation
Best Practice	<5 ohms
Acceptable	5 to 15 ohms
Marginal	15 to 25 ohms
Non-compliant	>25 ohms

## Lightning Protection Requirements

Lightning strikes the ground and follows the paths of least impedance to cause damage. To provide an effective lightning protection system, you must put the following fundamental measures in place:

- ❑ Install surge protectors. Every service entrance should have surge protection to stop the intrusion of lightning from outside.
- ❑ Implement bonding. Eliminate the opportunity for lightning to side-flash internally. The bonding resistance between any termination point and the related earthing rod should not exceed 0.01 ohms.
- ❑ Install grounding electrode system. The system should efficiently move the lightning to its final destination away from the structure and its contents. The resistance of the common grounding electrode must not exceed 5 ohms.
- ❑ Install cable conductors. Cable conductors route lightning current over and through the construction, without damage, toward the grounding electrode system.
- ❑ Use appropriate grounding. Systems without appropriate grounding can experience either complete system failures or intermittent problems that are hard to diagnose. Improper installation of electrical grounding components can make the components work ineffectively. Installing a system with the proper grounding equipment and following proper installation guidelines can reduce potential down time as well as costly repairs to system electronics.

---

### Note

The users of the plant or those responsible for the installation should apply the necessary measures (e.g., shielding, bonding, and grounding protection) to ensure that the interference voltages caused by lightning strikes do not exceed the available immunity level.

---

## Installation Worksheets

---

This section has two worksheets for planning the installation and record-keeping.

- ❑ Installation worksheet 1 - Table 8 on page 40: Use this worksheet to record the location of the power supply along with the voltages of the AC or DC input and DC output connectors. The worksheet also has an entry for the manufacturer and model name of the equipment enclosure, which is required for outdoor and some indoor installations.
- ❑ Installation worksheet 2 - Table 9 on page 41: Use this worksheet to record the basics of the powered devices connected to the power supply. This includes the products' model names, whether they are PoE source devices, and their power consumption values. The power consumption of a non-PoE source device is provided in its installation guide. The power consumption of a PoE source device requires knowing the consumption values of the source device as well as the powered devices, and summing the values. Copy the worksheet as many time as needed to record all the powered devices.

Table 8. Installation Worksheet 1: IE048-240 AC/DC Power Supply

Title	Description
Location	
Voltage of AC Input (Range 90Vac to 264Vac) or Voltage of DC Input (Range 88Vdc to 350Vdc)	
Voltage of DC Output Connectors <sup>1</sup> (Range 48.0Vdc to 55.0Vdc)	
Enclosure Manufacturer and Model Name	

1. 52Vdc default.



Table 9. Installation Worksheet 2: Powered Devices

Title	Description
Powered Device #___:	
Model Name	
PoE Source Device (Yes/No)	
Maximum Power Consumption	
Powered Device #___:	
Model Name	
PoE Source Device (Yes/No)	
Maximum Power Consumption	
Powered Device #___:	
Model Name	
PoE Source Device (Yes/No)	
Maximum Power Consumption	
Powered Device #___:	
Model Name	
PoE Source Device (Yes/No)	
Maximum Power Consumption	
Total Maximum Power Consumption	



## Chapter 3

# Installing the Power Supply

---

The procedures in this chapter are listed here:

- “Reviewing Power Supply Orientation” on page 44
- “Reviewing Power and Control Wires Guidelines” on page 46
- “Installing the Power Supply on a DIN Rail” on page 48
- “Connecting the Ground Wire” on page 50
- “Connecting the AC or DC Power Wires” on page 52
- “Adjusting the Voltage on the DC Output Connectors” on page 54
- “Wiring the DC Output Connectors to Powered Devices” on page 55
- “Wiring the Remote Control (RC) Connector” on page 57
- “Wiring the Power Alert DC\_OK Connector” on page 58
- “Verifying the Power Supply” on page 59

## Reviewing Power Supply Orientation

The power supply is cooled by convection airflow. The airflow direction is from bottom to top. Install the power supply vertically on a DIN rail to promote the best possible airflow and cooling. Refer to Figure 5.

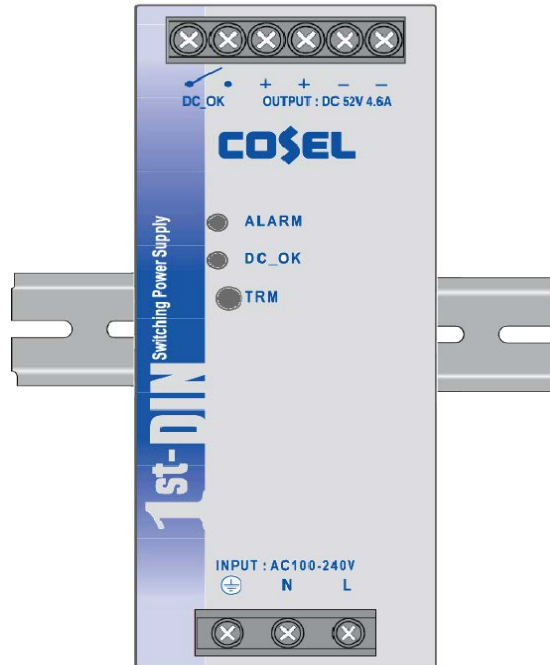

Figure 5. Vertical Installation

Do not install the power supply up-side-down or horizontally. This might cause the power supply to overheat from inadequate convection cooling. Refer to Figure 6.

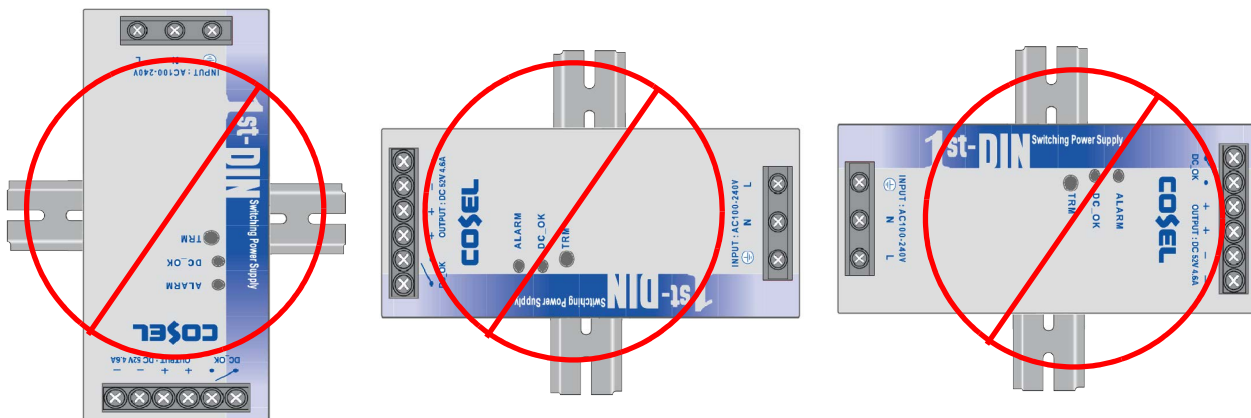

Figure 6. Unsupported DIN Rail Installations

Do not operate the power supply on a table, desk, or shelf. Refer to Figure 7.



Figure 7. Unsupported Table, Desk, or Shelf Installation

Allow for sufficient space for cooling between the power supply and adjacent objects or devices. Allied Telesis recommends a minimum space of 25mm between the top and bottom of the power supply and adjacent objects. Allied Telesis also recommends minimum spaces of 15mm on the left and right sides when adjacent objects are non-heating (e.g., walls or cabinets) and 50mm for adjacent heating sources (e.g., switches, routers, or other power supplies). Refer to Figure 8.

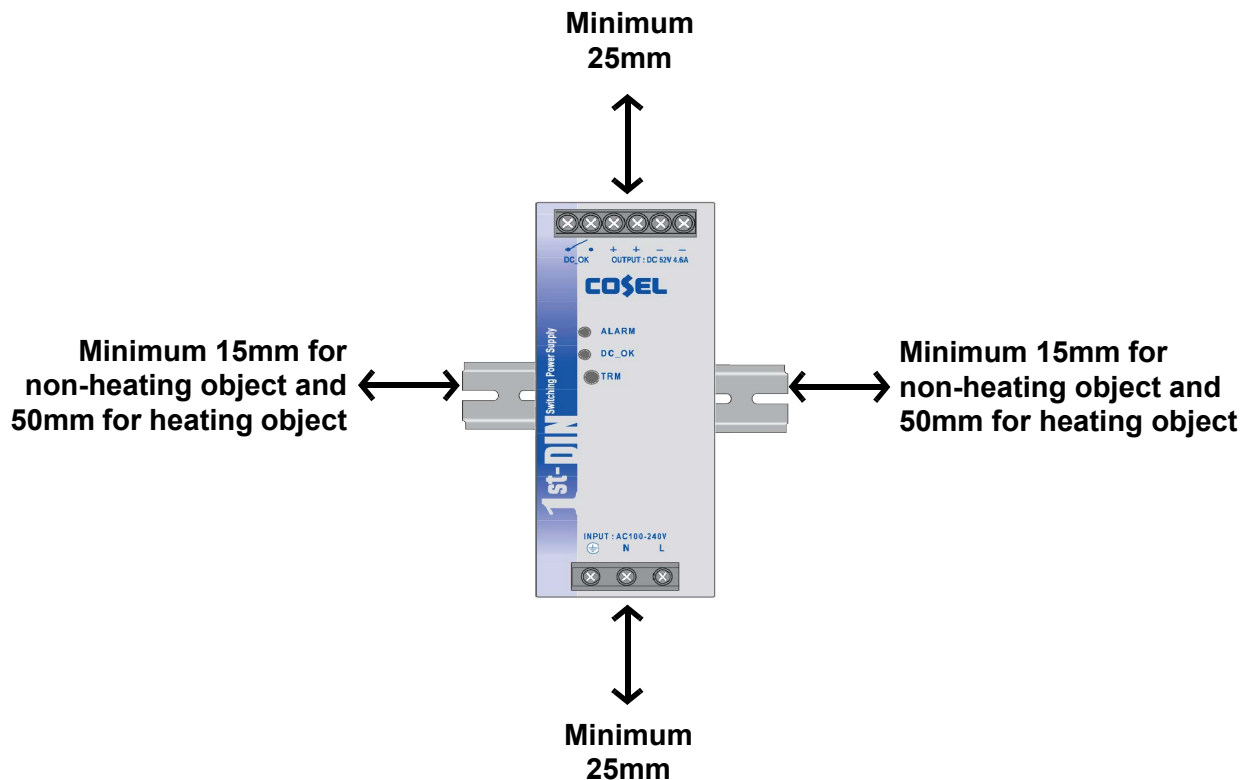

Figure 8. Minimum Spacing Requirements

## Reviewing Power and Control Wires Guidelines

The wire specifications for the connectors on the power supply are listed in Table 10.

Table 10. Wire Specifications

Connector	Wire	Description
AC/DC Input Connectors (N - Neutral and L - Live)	Solid Wire	AWG 20 to AWG 10 (Diameter 0.8 to 2.6mm)
	Stranded Wire	AWG 20 to AWG 10 (Diameter 0.5 to 5.2mm; Conductor diameter more than 0.18mm)
	Insulation Strip Length	8mm
Ground Wire	Solid Wire	Minimum AWG 16 (Diameter 1.3mm)
	Insulation Strip Length	8mm
DC Output Connectors	Solid Wire	AWG 20 to AWG 10 (Diameter 0.8 to 2.6mm)
	Stranded Wire	AWG 20 to AWG 10 (Diameter 0.5 to 5.2mm; Conductor diameter more than 0.18mm)
	Insulation Strip Length	8mm
RC Connectors and DC_OK Connectors	Solid Wire	AWG 24 to AWG 16 (Diameter 0.5 to 1.3mm)
	Stranded Wire	AWG 24 to AWG 16 (Diameter 0.2 to 1.5mm)
	Insulation Strip Length	8mm

Listed here are guidelines for preparing power and control wires:

- Do not strip more wire insulator than specified in Table 10.
- Keep the wires as short as possible to avoid unnecessary power loss.
- When using stranded wire, always tightly wrap the wire with your fingertips. This is to prevent loose strands from touching adjacent wires and causing electrical shorts. Refer to Figure 9 on page 47.

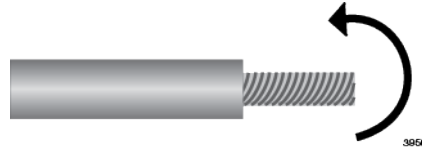

Figure 9. Wrapping Wire Strands

- ❑ For added protection against loose strands, tin stranded wires with solder or use electric wire ferrules.
- ❑ Do not route wires on the floor or other areas where they might pose a hazard.
- ❑ After installing wires, visually inspect them for exposed wires or loose wire strands. Refer to Figure 10.

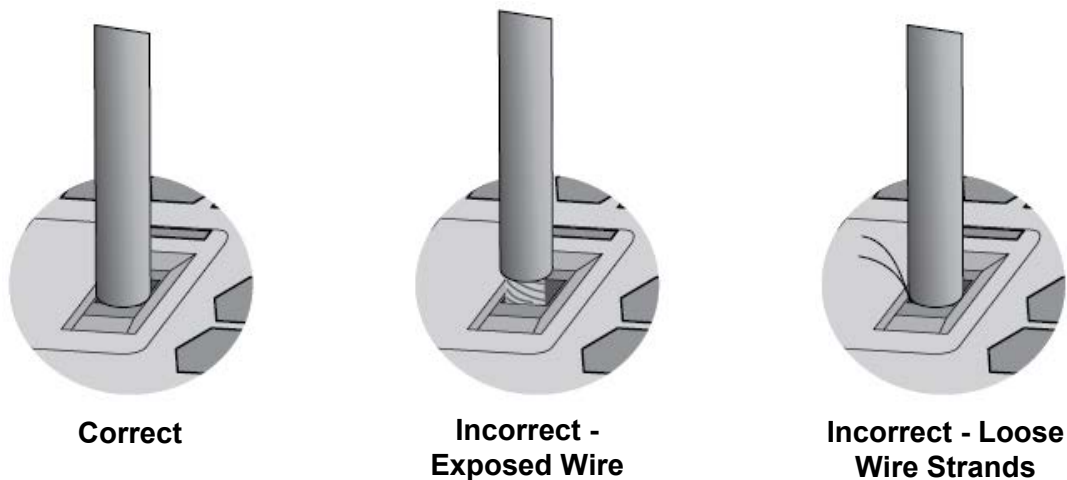

Figure 10. Verifying Wire Installation

**Warning**

Check to see if there are any exposed copper strands coming from the installed wires. When the installation is done correctly there should be no exposed copper wire strands extending from the terminal block. Any exposed wiring can conduct harmful levels of electricity to persons touching the wires. E12

## Installing the Power Supply on a DIN Rail

---

The IE048-240 Power Supply comes with a DIN rail bracket on the back panel for 35x7.5mm and 35x15mm rails. Review the following guidelines before installing the power supply:

- ❑ Depending on the installation site, it may be easier to wire the connectors before installing the power supply on the DIN rail. For instructions, begin with “Connecting the Ground Wire” on page 50.
- ❑ To install the power supply on a concrete, metal, or other non-combustible wall, install a short length of DIN rail on the wall. Allied Telesis sells packets of five 35x7.5mm DIN rails for wall installations. Refer to Figure 4 on page 29 and the Allied Telesis web site for details.



### Warning

The device must be installed in a fire protection enclosure when installed on walls of combustible material (e.g., wood). Additionally, the floor area directly below the power supply should be non-combustible (e.g., metal or concrete) and be free of combustible material (e.g., paper, plastic, or wood). *See* E134

---

To install the power supply on a DIN rail, place the upper notch on the bracket over the top rail edge (A) and push the lower edge of the power supply (B) until the bracket snaps onto the rail. Refer to Figure 11.

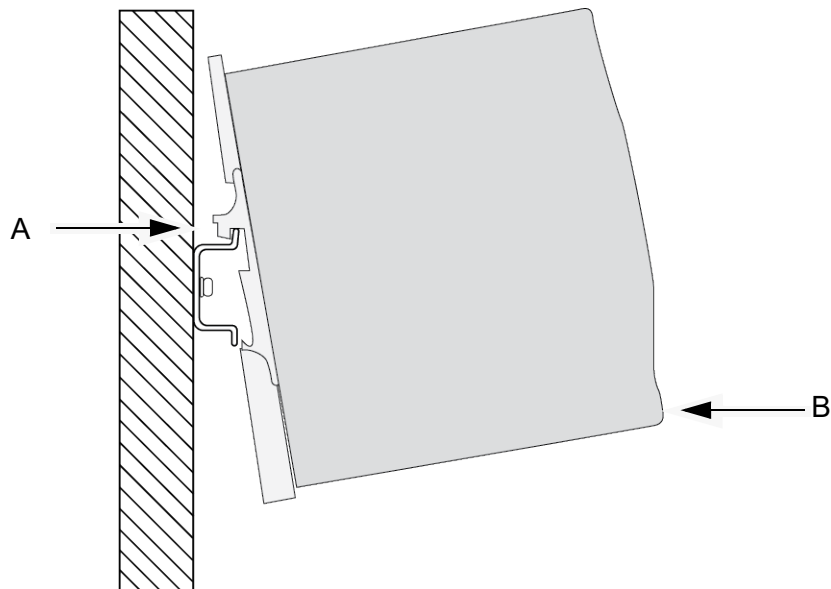

Figure 11. Installing the Power Supply on a DIN Rail



Visually inspect the bracket to verify that the DIN rail is fitted into the top and bottom bracket slots.

---

**Note**

Allied Telesis recommends installing DIN rail end clamps to the sides of the device to prevent damage or network traffic loss from vibration or shock. End clamps are not available from Allied Telesis.

---

## Connecting the Ground Wire

---

This section contains the procedure for installing the ground wire.



### Warning

When installing the equipment, always connect the frame ground wire first and disconnect it last. ⚡ E11

---

The procedure requires the following items:

- ❑ One ground wire. Refer to Table 10 on page 46 for the specifications.
- ❑ Cross-head screwdriver (not provided).
- ❑ Wire insulator stripper (not provided).

To install the ground wire, perform the following procedure:

1. Prepare an adequate length of wire by stripping 8mm of insulation from one end.
2. Loosen the ground screw on the front panel of the power supply and insert the ground wire in the connector on the bottom panel. Refer to Figure 12.

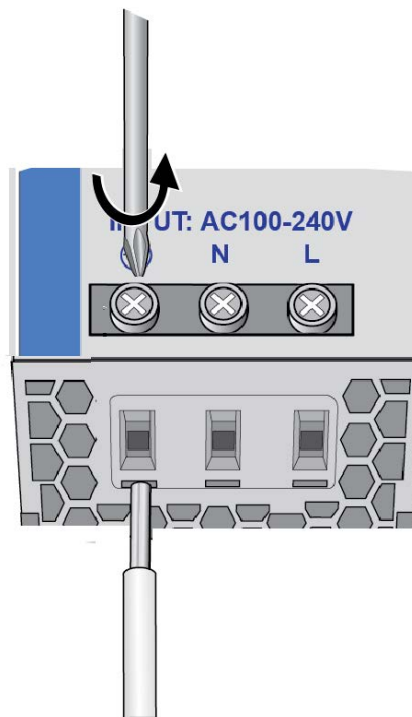

Figure 12. Installing the Ground Wire

3. Tighten the ground screw to secure the ground wire to the power supply (tightening torque: 1 Nm).
4. Visually inspect the wire for exposed wire and loose strands. Refer to Figure 10 on page 47.
5. Connect the other end of the ground wire to the building's protective earth.

## Connecting the AC or DC Power Wires

---

The procedure requires the following items:

- ❑ Two AC or DC power wires. Refer to Table 10 on page 46 for the specifications.
- ❑ Cross-head screwdriver (not provided).
- ❑ Wire insulator stripper (not provided).

---

**Note**

When selecting and installing AC or DC power wires, be sure to follow all industry rules, restrictions, and guidelines that apply to your locale, such as insulator color, length, and routing.

---

**Warning**

Never handle live AC power wires. Confirm that the AC circuit breaker is powered off before attaching the wires to the circuit breaker or power supply. Always connect the wires to the power supply first and then to the AC circuit breaker. ⚡ E135

---

**Warning**

Do not handle live DC power wires. Connect the wires to the powered device first and then to the power supply. ⚡ E135

---

To attach the AC or DC power wires to the power supply, perform the following procedure:

1. Verify that the AC or DC circuit breaker is powered off.
2. Loosen the two N (Neutral) and L (Live) screws on the front panel of the power supply and insert the AC or DC power wires into the connectors on the bottom panel. Refer to Figure 13 on page 53.

---

**Note**

To power the unit with a DC power source, connect the Positive (+) wire to the L (Live) connector and the Negative (-) wire to the N (Neutral) connector.

---

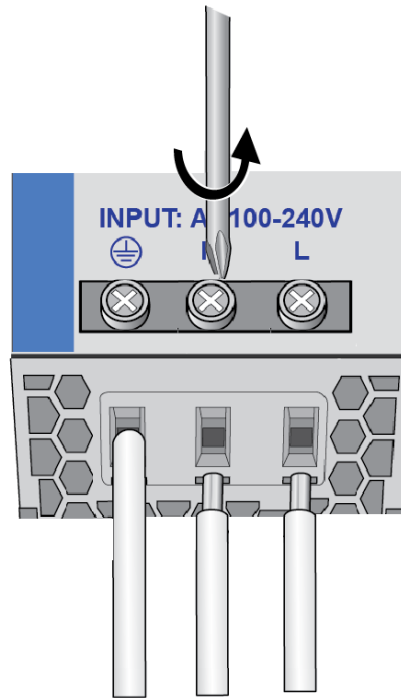

Figure 13. Installing the AC or DC Power Wires

3. Tighten the N and L screws to secure the wires to the power supply (tightening torque: 1Nm).
4. Visually inspect the wires for exposed wires and loose strands. Refer to Figure 10 on page 47.
5. Connect the wires to the AC or DC circuit breaker.
6. To test and adjust the voltage on the DC output connectors, go to “Adjusting the Voltage on the DC Output Connectors” on page 54. Otherwise, go to “Wiring the DC Output Connectors to Powered Devices” on page 55.

## **Adjusting the Voltage on the DC Output Connectors**

---

This procedure explains how to verify and adjust the output voltage on the DC output connectors with the TRM screw on the front panel. The range is 48.0Vdc to 55.0Vdc. The default is 52Vdc. Perform this procedure before connecting powered devices to the power supply to verify that the power supply is supplying the correct voltage.

The following procedure assumes you have already connected the power supply to the AC or DC power source. For instructions, refer to “Connecting the AC or DC Power Wires” on page 52.

To verify and adjust the output voltage on the DC output connectors, perform the following procedure:

1. Power on the IE048-240 Power Supply by powering on the AC or DC circuit breaker.
2. Connect a volt meter to one positive and one negative DC Output connector on the front panel.
3. Test and adjust the output voltage. To increase the voltage, turn the TRM screw clockwise. To decrease it, turn the screw counterclockwise.
4. Remove the volt meter.
5. Go to “Wiring the DC Output Connectors to Powered Devices” on page 55.

## Wiring the DC Output Connectors to Powered Devices

---

Connecting a powered device to the IE048-240 Power Supply requires the following items:

- ❑ Two DC power wires. Refer to Table 10 on page 46 for the specifications.
- ❑ Cross-head screwdriver (not provided).
- ❑ Wire insulator stripper (not provided).



### Warning

Do not handle live DC power wires. Connect the wires to the powered device first and then to the power supply. ⚡ E136

---

### Note

Connecting more than two devices to the power supply requires a power distribution system, such as DC power bus bars. This guide does not explain how to install power distribution systems. Consult with a qualified electrician.

---

### Note

The power supply does not support parallel, backup, or redundancy operation.

---

To connect a powered device to the DC Output connectors, perform the following procedure:

1. Prepare adequate lengths of cables by stripping 8mm of insulation from the ends.
2. Connect the DC power wires to the DC positive and negative connectors on the powered device. Refer to the device's installation guide for instructions.
3. Loosen the screws for one positive (+) connector and one negative (-) connector on the front panel of the power supply and insert the wires into the connectors on the top panel. The positive connectors are connected internally in the power supply. The negative connectors are also connected internally. You can use either of the positive connectors with either of the negative connectors. Refer to Figure 14 on page 56.



**Caution**

Do not crossover the wires. Be sure to connect the positive connector on the power supply to the positive connector on the powered device, and the negative connector on the power supply to the negative connector on the powered device. E137

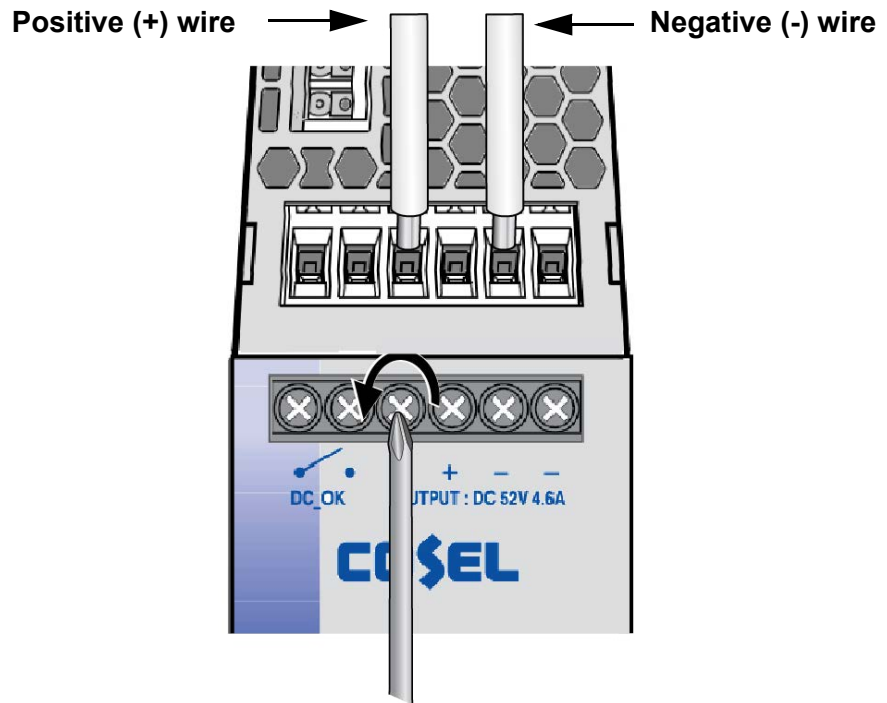

Figure 14. Installing DC Output Power Wires

4. Tighten the screws to secure the wires (tightening torque: 1 Nm).
5. Visually inspect the wires for exposed wires and loose strands. Refer to Figure 10 on page 47.
6. To connect a second powered device to the power supply, repeat this procedure.



## Wiring the Remote Control (RC) Connector

For background information, refer to “Remote Control Connector for Turning On or Off the DC Output Connectors” on page 25. This procedure requires the following:

- ❑ Two RC connector wires. Refer to Table 10 on page 46 for the specifications.
- ❑ Cross-head screwdriver (not provided).
- ❑ Wire insulator stripper (not provided).
- ❑ Electronic device for powering on and off the circuit (not provided).

To wire the Remote Control connector, perform the following procedure:

1. Prepare adequate lengths of cables by stripping 8mm of insulation from the ends.
2. Loosen the two RC connector screws on the top panel and insert the positive and negative wires into the connectors. Refer to Figure 15.

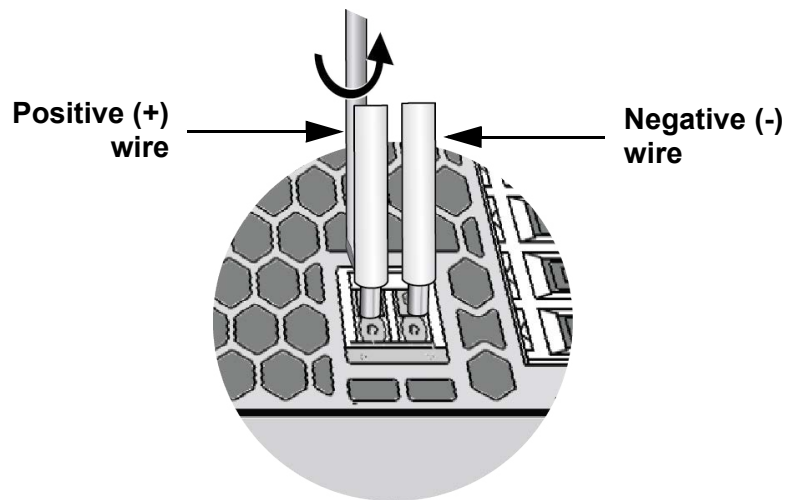

Figure 15. Wiring the RC Connector

3. Tighten the screws to secure the wires (tightening torque: 1 Nm).
4. Visually inspect the wires for exposed wires and loose strands. Refer to Figure 10 on page 47.
5. Connect the other ends of the wires to the electronic device that will power on and off the circuit.

## Wiring the Power Alert DC\_OK Connector

---

For background information, refer to “Power Alert DC\_OK Connector” on page 27. This procedure requires the following:

- ❑ Two DC\_OK connector wires. Refer to Table 10 on page 46 for the specifications.
- ❑ Cross-head screwdriver (not provided).
- ❑ Wire insulator stripper (not provided).
- ❑ Alert device (not provided).

To wire the Power Alert DC\_OK connector, perform the following procedure:

1. Prepare adequate lengths of cables by stripping 8mm of insulation from the ends.
2. Loosen the two DC\_OK connector screws on the front panel and insert the wires into the connectors on the top panel. Refer to Figure 16.

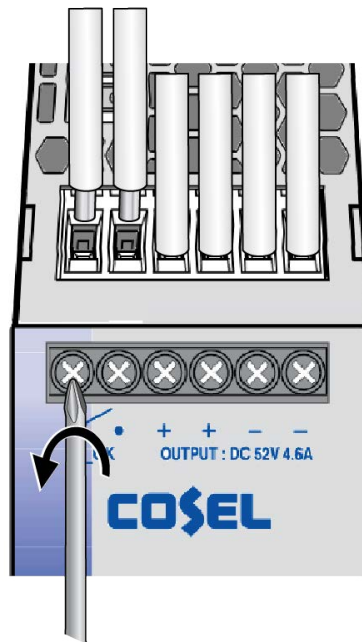

Figure 16. Wiring the DC\_OK Connector

3. Tighten the screws to secure the wires (tightening torque: 1 Nm).
4. Visually inspect the wires for exposed wires and loose strands. Refer to Figure 10 on page 47.
5. Connect the wires to the alert device.

## Verifying the Power Supply

---

To verify the power supply and powered devices, perform the following procedure:

1. If the power supply is powered off, turn on the AC or DC circuit breaker.
2. Inspect the ALARM and DC\_OK LEDs on the front panel. The ALARM LED should be off and the DC\_OK LED should be steady green.
3. Wait for the powered devices to power on and start their management software.
4. Examine their LEDs to verify that they are operating normally. Refer to the devices' installation guides for LED descriptions.
5. For Power over Ethernet (PoE) switches, start management sessions and display their power budgets for powered devices. For example, the SHOW POWER-INLINE command displays the power budgets on the IE Series of Ethernet switches from Allied Telesis. Refer to their installation or management user guides for instructions.



## Chapter 4

# Troubleshooting

---

This chapter provides suggestions on how to troubleshoot the IE048-240 Power Supply in the event a problem occurs.

---

**Note**

For further assistance, contact Allied Telesis Technical Support at [www.alliedtelesis.com/support](http://www.alliedtelesis.com/support).

---

**Problem 1:** The ALARM and DC\_OK LEDs on the IE048-240 Power Supply are off.

**Solutions:** Try the following:

- ❑ Verify that the AC or DC power source is powered on and operating properly.
- ❑ Verify that the AC or DC circuit breaker is On.
- ❑ Verify that the AC or DC power wires are correctly and securely connected to the L (Live) and N (Neutral) connectors on the power supply and to the AC or DC circuit breaker. For instructions, refer to “Connecting the AC or DC Power Wires” on page 52.
- ❑ Verify the AC or DC circuit breaker has power by connecting another device to it.
- ❑ Measure the output power on the AC or DC circuit breaker to verify that the power source is compatible with the power specifications of the power supply. Refer to Table 15 on page 67 for the power specifications of the power supply.
- ❑ Measure the ambient temperature of the site to determine whether the power supply shut down because of high temperature. If necessary, increase the ventilation at the site. Refer to “Derating Graphs - Operating Properties and Ambient Temperature” on page 70.
- ❑ Verify that the power supply is installed vertically and that there is adequate spacing between it and adjacent devices to prevent overheating. Refer to “Reviewing Power Supply Orientation” on page 44.
- ❑ If you are using the RC connectors to remotely turn on and off the DC output connectors, use the RC connectors to turn on the DC output connectors.
- ❑ Try power cycling the power supply by powering off and on the AC or DC circuit breaker.

- ❑ Try connecting the power supply to a different AC or DC circuit breaker or power supply.
- ❑ Verify that the positive and negative voltages on the DC Output connectors are not shorted.

**Problem 2:** The ALARM LED is amber, signaling that the DC output of the power supply is below or above normal operating levels.

**Solutions:** Try the following:

- ❑ Verify that the AC or DC power source is operating properly.
- ❑ Verify that the AC or DC power wires are correctly and securely connected to the L (Live) and N (Neutral) connectors on the power supply and the AC or DC circuit breaker. Refer to “Connecting the AC or DC Power Wires” on page 52.
- ❑ Measure the ambient temperature of the site to determine whether the decrease in power from the power supply is due to high temperature. If necessary, increase the ventilation at the site. Refer to “Derating Graphs - Operating Properties and Ambient Temperature” on page 70.
- ❑ Verify that the power supply is installed vertically and that there is adequate spacing between it and adjacent devices to prevent overheating. Refer to “Reviewing Power Supply Orientation” on page 44.
- ❑ Determine the total maximum power consumption value of the powered devices connected to the IE048-240 Power Supply by referring to their documentation. If the value exceeds 240W, remove one or more devices from the power supply.
- ❑ Try connecting the power supply to a different AC or DC power circuit.

**Problem 3:** The DC\_OK LED is green and the ALARM is off, but the power supply is supplying little or no power to a device.

**Solutions:** Try the following:

- ❑ Verify that the DC power wires are securely and correctly connected to the positive (+) and negative (-) connectors on both the power supply and powered device. Refer to Figure 1 on page 19, Figure 2 on page 20, and “Wiring the DC Output Connectors to Powered Devices” on page 55.
- ❑ Verify that the power wires are not crossed over from the power supply to the device. The positive (+) DC output connector on the power supply must be connected to the powered device’s positive connector, and the negative (-) DC output connector on the power supply must be connected to the powered device’s negative connector.

- ❑ Determine the total maximum power consumption value of the powered devices connected to the IE048-240 Power Supply by referring to their documentation. If the value exceeds 240W, remove one or more devices from the power supply.
- ❑ Measure the ambient temperature of the site to determine whether the decrease in power from the power supply is due to high temperature. If necessary, increase the ventilation at the site. Refer to “Derating Graphs - Operating Properties and Ambient Temperature” on page 70.
- ❑ Verify that the powered device and the power supply are connected with the correct weight of copper wire. Refer to Table 2 on page 23.
- ❑ Try replacing the copper wires.
- ❑ Try replacing the device. If the new device works, than the problem is with the first device.

**Problem 4:** A PoE switch powered by the IE048-240 Power Supply is not providing power or stopped providing power to one or more PoE devices.

**Solutions:** Try the following:

- ❑ Refer to the switch’s installation guide or product data sheet for its maximum power budget for PoE devices. Calculate the total power requirements of all the powered devices connected to the device by referring to their installation guides. The switch cannot support all the devices if its power budget is less than their total power requirements. If this is the case, remove some powered devices from the switch.
- ❑ Measure the ambient temperature of the site to determine whether the power supply reduced output DC power because of high temperature. If necessary, increase the ventilation at the site. Refer to “Derating Graphs - Operating Properties and Ambient Temperature” on page 70.
- ❑ Try adjusting the voltage on the DC Output Connectors with the TRM screw. Refer to “TRM Screw for Adjusting the Output DC Voltage” on page 24 and “Adjusting the Voltage on the DC Output Connectors” on page 54.
- ❑ Refer to the switch’s installation guide for more troubleshooting suggestions for PoE devices.
- ❑ The switch or powered device has a technical problem.





## Appendix A

# Technical Specifications

---

This appendix contains the following sections:

- “Physical Specifications” on page 66
- “Power Specifications” on page 67
- “Environmental Specifications” on page 69
- “Derating Graphs - Operating Properties and Ambient Temperature” on page 70
- “Device Dimensions” on page 72

## Physical Specifications

---

### Dimensions

Table 11. Product Dimensions (W x D x H)

IE048-240	50 x 117 x 124 mm (1.97 x 4.61 x 4.88 in.)
-----------	---

### Weight

Table 12. Product Weight

IE048-240 with DIN rail bracket	0.9 kg (1.98 lbs)
---------------------------------	-------------------

### Ventilation

Table 13. Ventilation Requirements

Minimum Open Space Left and Right Sides with Adjacent Non-heat Sources	15mm (0.59 in)
Minimum Open Space Left and Right Sides with Adjacent Heat Sources	50mm (1.97 in)
Minimum Open Space Above and Below	25mm (1.0 in)

### Cabinet (Enclosure) Dimensions

Table 14. Minimum Cabinet (Enclosure) Dimensions

Minimum Cabinet Dimensions (W x H x D)	50.8 x 50.8 x 30.5 cm (20.0 x 20.0 x 12.0 in)
--	--

#### Note

The enclosure size should be determined by considering multiple factors. This includes the outside ambient temperature, total heat generated from the installed equipment, sealed or unsealed enclosure type, enclosure material, paint color, mounting method (wall, pole, ground, etc.), and sun load. The smaller enclosure size you choose, the higher risk of overheating the product.

If the product overheats in an enclosure that was built without taking into account these factors, the warranty of the product might be voided. Consult Allied Telesis when assistance is needed.

---

## Power Specifications

---

The power input and output specifications are listed in Table 15 and Table 16.

Table 15. Input Power Specifications

Voltage		90 to 264Vac or 98 to 350Vdc
Current	@115Vac	2.3A typ.
	@230Vac	1.2A typ.
Frequency		50/60Hz (45 to 66Hz) or DC
Efficiency	@115Vac	92 typ.
	@230Vac	94 typ.
Power Factor	@115Vac	0.98 typ.
	@230Vac	0.93 typ.
Inrush Current	@115Vac	20A typ. <sup>1</sup>
	@230Vac	40A typ. <sup>1</sup>
Leakage Current	100Vac	≤0.45mA
	240Vac	≤0.75mA
Line Noise Tolerance		2kV, 50 to 1,000ms, ±0~360°

1. More than 3s to re-restart.

Table 16. Output Power Specifications

Voltage (nominal)		52Vdc
Current		4.6A
Peak Current		4.6A
Line Regulation		≤192mV <sup>1</sup>
Load Regulation		≤300mV <sup>1</sup>

Table 16. Output Power Specifications (Continued)

Ripple	0° to 70°C	≤240mVp-p
	-25° to 0°C	≤500mVp-p
	Io=0 - 30%	≤7500mVp-p
Ripple Noise	0° to 70°C	≤300mVp-p
	-25° to 0°C	≤580mVp-p
	Io=0 - 30%	≤750mVp-p
Line Noise Tolerance		2kV, 50 to 1,000ms, ±0~360°
Temperature Coefficient	0° to 70°C	≤480mV
	-25° to 70°C	≤600mV
Voltage Accuracy (Maximum)	0° to 70°C	≤486mV
	-25° to 70°C	≤606mV
Drift		≤192mV
Start-up Time		≤750ms <sup>2</sup>
Hold-up Time		20ms typ. <sup>2</sup>
Output Voltage Adjustment Range		48.0 to 55.0Vdc <sup>3</sup>
Default Output Voltage Setting		52.0Vdc ±1%
Protection <sup>4</sup>	Over current	>101% of peak current
	Over voltage	58.1 to 68.0Vdc
	Over temp	Yes

1. Io=30 - 100%, burst operation at ≤ 30% load

2. Input voltage: 115Vac, Io=100%

3. The maximum output power is 240W.

4. Automatic recovery.

## Environmental Specifications

---

Table 17. Environmental Specifications

Operating Temperature Range	-25° to 70°C <sup>1</sup>
Storage Temperature Range	-40° to 85°C
Operating Humidity Range	20% to 90% RH, non-condensing
Storage Humidity Range	
Operating Altitude	5,000m
Cooling Method	Air Convection

1. Tested for startup at -40°C.



---

### Warning

The power supply must be installed in a UL-Listed 3X or 4X enclosure when installed in an outdoor environment. *GE* E133

---



---

### Note

The power supply must be installed in a UL-Listed or Nationally Recognized Test Lab enclosure when installed in an indoor Measurement, Control, or Laboratory environment, as specified in UL/EN/IEC 61010-1 and 61010-2-201.

---

## Derating Graphs - Operating Properties and Ambient Temperature

The derating graphs are shown in Figure 17, Figure 18 on page 71, and Figure 19 on page 71. The input voltages ( $V_{in}$ ) in the derating graphs include a tolerance of  $\pm 10\%$  nominal value. The derating properties correspond to a vertically mounted device. The operational ambient temperature varies depending on mounting orientation. Vertical orientation for the device is strongly recommended for best convection cooling. Refer to “Reviewing Power Supply Orientation” on page 44.

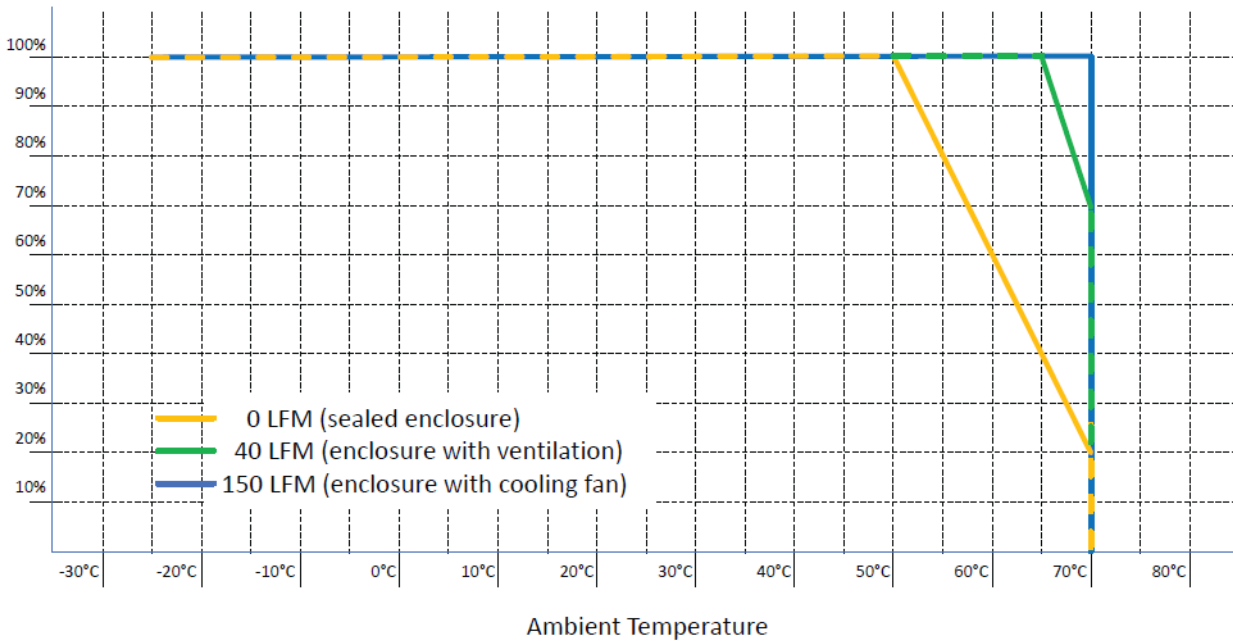

Figure 17. Derating Graph at 100Vac

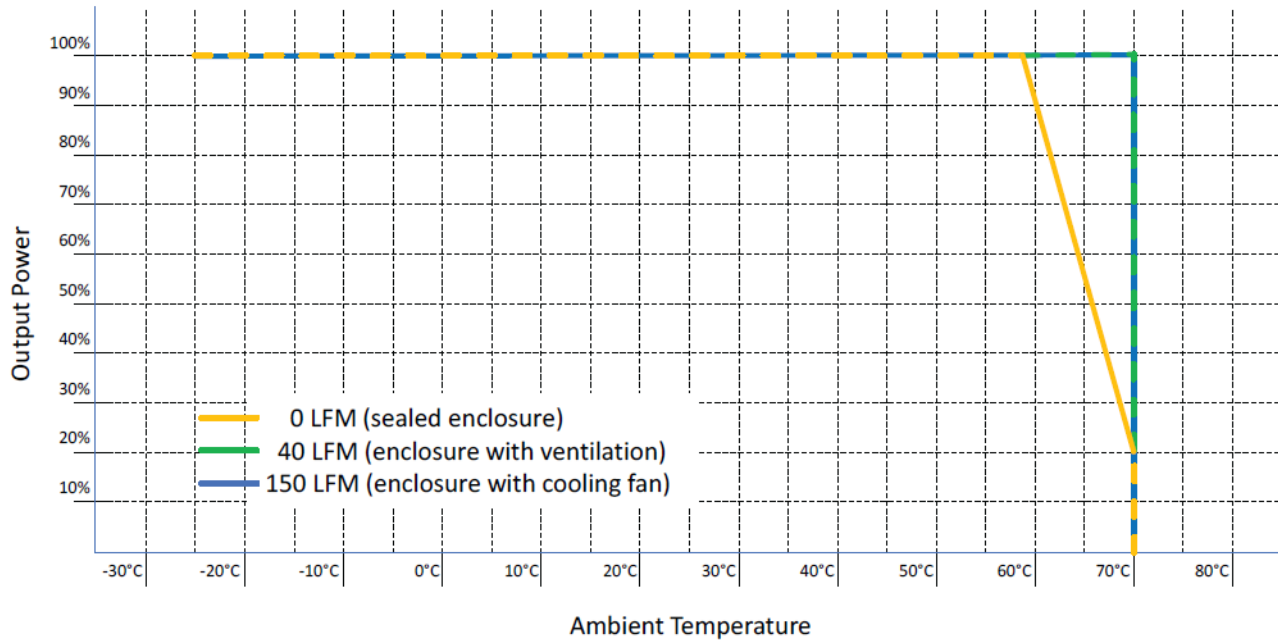

Figure 18. Derating Graph at 230Vac

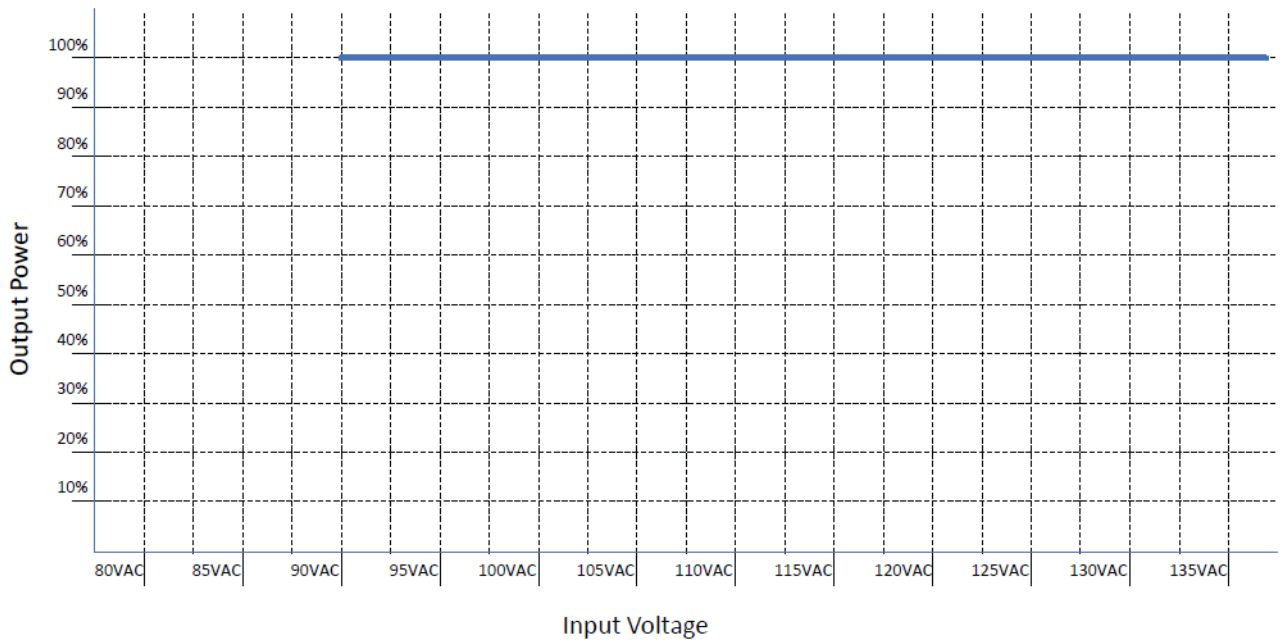

Figure 19. Derating Graph at Input Voltage

## Device Dimensions

---

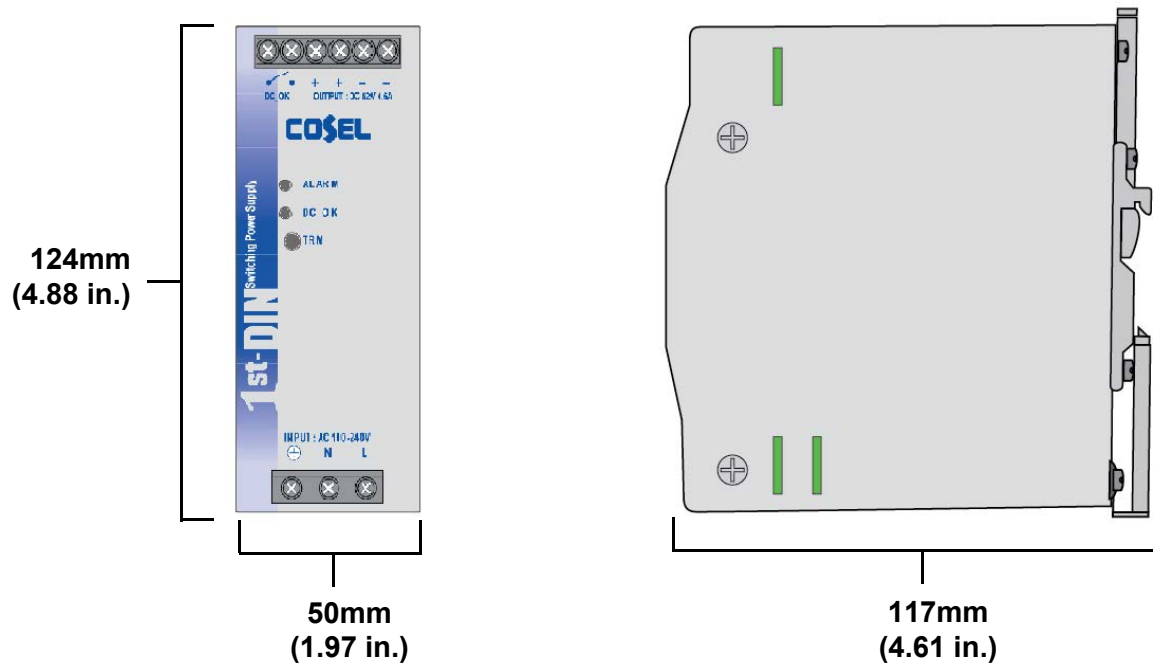

Figure 20. IE048-240 Power Supply Dimensions